



The Way  
to Fish®







# Scotty®

**SINCE 1952**

## YEARS OF QUALITY, INNOVATION AND CUSTOMER SERVICE

A family business for over 66 years, Scott Plastics Ltd. has grown from a local BC company to operating and shipping worldwide. The company is now situated near the YYJ Victoria International Airport in an 85,000 sq.ft. manufacturing plant built in 2000, and has recently expanded. The Scotty trademark has become recognized to mean product excellence. The total commitment to quality, fair pricing and unmatched service means our customers everywhere can expect reliability and satisfaction from every product that carries the Scotty name. This commitment has taken us to where we are today and will hopefully serve us well for many years to come. All products are backed by years of manufacturing experience and the highest quality customer service. Excellent vendor support and a superior product have made Scotty a leader in the fishing industry.

## SCOTTY: THE WAY TO FISH!

In 1952, Blaney Scott and his wife Almada Scott started a small company in Victoria British Columbia that pioneered the use of plastics in the manufacturing of salmon fishing, lures and other marine products. From humble beginnings, Scott Plastics Ltd. evolved to produce thousands of products under the Scotty trademark which are sold to the fishing, marine, outdoor and firefighting industries worldwide.





# SCOTTY FISHING & OUTDOOR PRODUCTS LOCATION

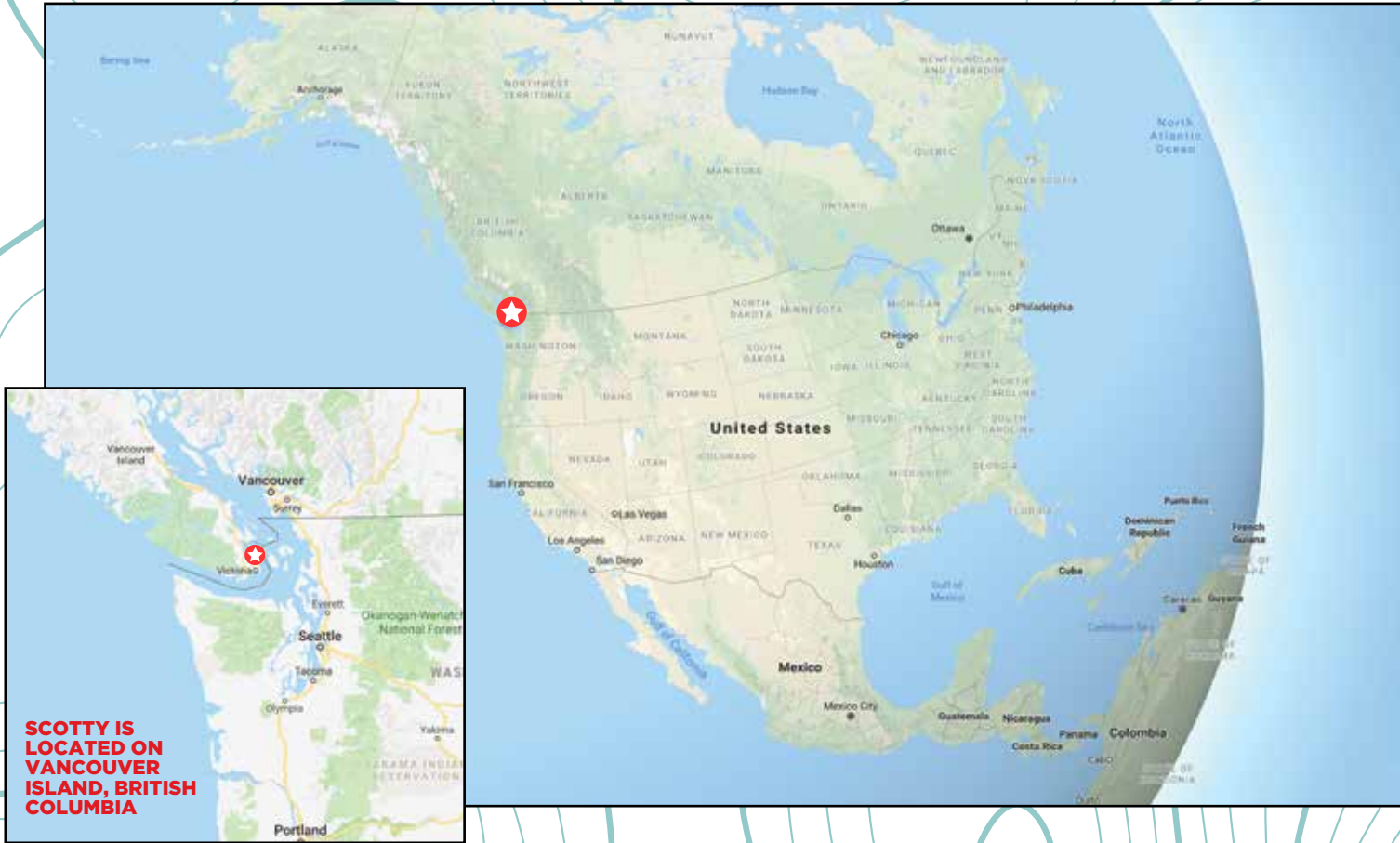

SCOTTY IS LOCATED ON VANCOUVER ISLAND, BRITISH COLUMBIA

## STAY CONNECTED

-  **FACEBOOK**  
@scottysfishingproducts
  -  **INSTAGRAM**  
#scottysproducts
  -  **TWITTER**  
@scottysproducts
  -  **YOUTUBE**  
#scottysproducts
- www.scotty.com  
www.scottypaddlesports.com  
www.scottysfire.com

## LEGEND

-  **Water Surface**  
Best suited for still water
-  **Vessel Recommendation**  
Suited for paddle sports
-  **No assembly required**
-  **Factory and field tested**
-  **Colour options**

## PHOTO CREDITS

Cover	Derek Ford Photography
Page 5	Silver Streak Boats
Page 5	Bill DePriest/Pacific Coast Sports Fishing Magazine
Page 5	Derek Ford Photography
Page 5	Hobie
Page 9	Derek Ford Photography
Page 11	Bill DePriest/Pacific Coast Sports Fishing Magazine
Page 13	Fougere Family Adventures
Page 15	Sea Eagle Boats Inc.
Page 26	Derek Ford Photography
Page 30	Derek Ford Photography
Page 35	Derek Ford Photography
Page 37	Derek Ford Photography
Page 39	Derek Ford Photography
Page 41	Derek Ford Photography
Page 43	Derek Ford Photography
Page 45	KingFisher Boats
Page 46	Pelican Kayaks
Page 47	Pelican Kayaks
Page 48	Stryker Boats
Page 52	Derek Ford Photography
Page 56	Derek Ford Photography
Page 59	Derek Ford Photography
Page 60	Pelican Kayaks
Page 64	Dustin Dorskocil Photography
Page 65	Kayak Angler Magazine/Rapid Media



## CONTENTS

- 6 CHOOSING YOUR DOWNRIGGER**
  - DOWNRIGGERS**
  - 6 what is a Downrigger
  - 8 high performance
  - 10 depthpower
  - 12 manual
  - 14 compact
  - 15 lake troller
  - DOWNRIGGER PARTS & ACCESSORIES**
  - 17 cable & line
  - 18 parts & accessories
  - 20 downrigger tackle
  - LINE RELEASES**
  - 22 power grip plus
  - 22 mini power grip plus
  - 23 snapper
  - 23 mini snapper
  - 23 hairtrigger
  - LINE PULLERS**
  - 24 electric
  - 24 manual
  - ROD HOLDERS**
  - 26 orca
  - 28 striker
  - 30 power lock
  - 32 rodmaster & rodmaster II
  - 33 rocket launcher
  - 33 side winder
  - 34 baitcaster spinning
  - 36 fly rod
  - MOUNTS**
  - 39 electronic mounts
  - 40 ball mounting system
  - 42 post mounts
  - 43 adapters
  - 43 triple mounting system
  - 44 downrigger mounts
  - 45 compact downrigger mounts
  - 45 downrigger dual rod holder
  - 46 low profile track
  - 47 gear head
  - 48 glue/stick on mounts
  - ACCESSORIES**
  - 51 fishing accessories
  - 52 extensions & adapters
  - 54 bait board
  - 55 bait jars
  - 56 anchor lock
  - 57 boat accessories
  - PADDLE SPORTS**
  - 59 stand up paddle board
  - 60 kayak accessories
  - SAFETY EQUIPMENT**
  - 63 pumps
  - 64 sea-light
  - 65 SOCIAL MEDIA**
  - JORDAN-SCOTTY**
  - 66 fish egg incubator systems



# What is a Downrigger?

## FIGHT THE FISH, NOT THE FISHING GEAR

Downriggers were created for one principal reason: to allow anglers to troll their lures at a specific depth. Years of testing and practical use have shown that a moving bait or lure in the water, trolled at the depth where fish are present, is the best way to ensure a hookup and to get results. Downriggers improved both trolling results, and the fun factor. They put the sport back in sport fishing. The earliest Downriggers were very simple in form, generally consisting of a spool of wire mounted to the

boat with a heavy weight hung on the end of the wire. The lure or bait was attached directly to the Downrigger weight and did not release when a fish struck. The angler had to wind up both the weight and the fish. This concept of deep trolling became popular with sport fishermen when the idea of attaching a rod to the Downrigger, by means of a release clip, was introduced. A release clip is attached to the wire and then the fishing line from the rod is clipped into the release. The Downrigger

weight is then lowered to precisely the depth required. When a fish hits, the line is released from the Downrigger wire, leaving the heavy weight on the Downrigger. The angler is then free to fight the fish on the rod and reel alone, without the added drag of heavy lines and trolling weights used in the past. Scotty introduced its first Downrigger over 40 years ago and now produces the most complete range of Downriggers and accessories in the world.

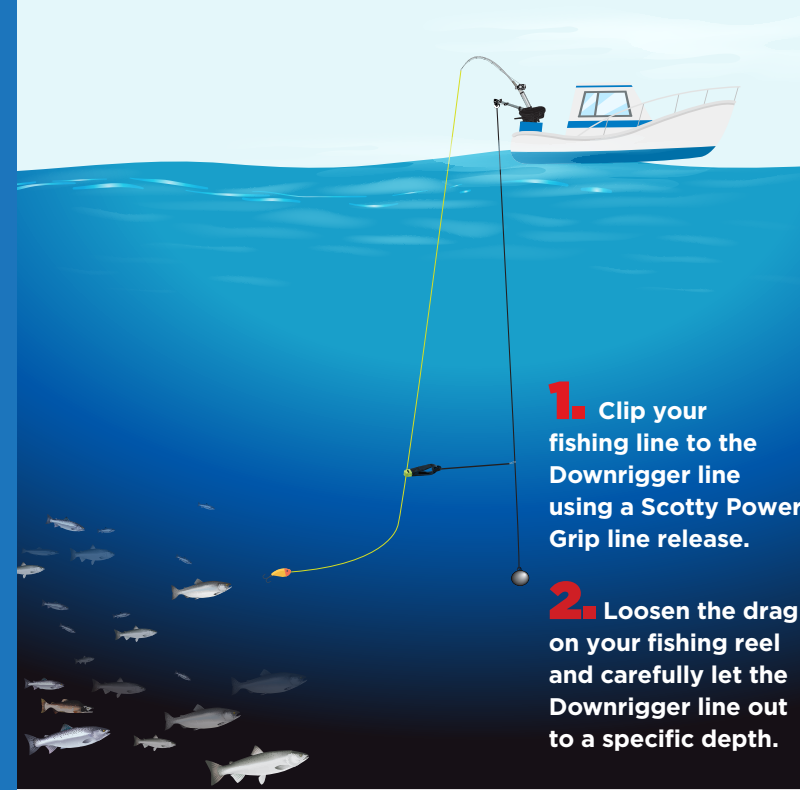

**1.** Clip your fishing line to the Downrigger line using a Scotty Power Grip line release.

**2.** Loosen the drag on your fishing reel and carefully let the Downrigger line out to a specific depth.

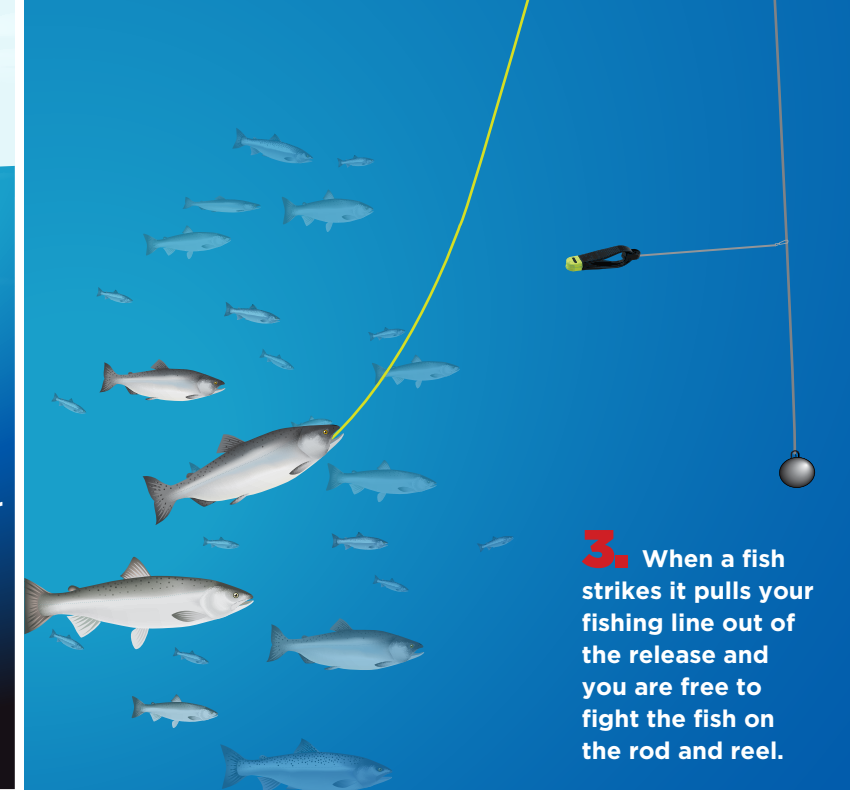

**3.** When a fish strikes it pulls your fishing line out of the release and you are free to fight the fish on the rod and reel.

# Choosing your Downrigger

## ELECTRIC DOWNRIGGER SPECS

All Electric Models have 12 v Marincor™ corrosion resistant plug + socket, locking tilt up mount, large surface automatic brake, spray protected positive-drive depth counter, Kevlar™ belt driven and an auto stop with jog button feature. **EACH SCOTTY DOWNRIGGER IS FACTORY ASSEMBLED AND LOAD TESTED.**

	HIGH PERFORMANCE			DEPTHPOWER				
	2106	2106B	2116 PROPACK	1099	1101	1106	1106B	1116 PROPACK
<b>STAINLESS STEEL CABLE</b> • premium test 150 lb. • premium test 180 lb.				250 ft.	250 ft.	250 ft.		250 ft.
<b>BRAIDED LINE</b> • premium test 200 lb. • premium test 250 lb.		300 ft.					300 ft.	
16 POSITION SWIVEL MOUNTING BASE	✓	✓	✓	SOLD SEPARATELY	✓	✓	✓	✓
POWER GRIP PLUS LINE RELEASE MODEL NO.	1170	1170	1170 & 1171	1170	1170	1170	1170	1170 & 1171
ROD HOLDER MODEL	470 ROCKET LAUNCHER	470 ROCKET LAUNCHER	447 DUAL ROCKET LAUNCHER	355 RODMASTER II	358 RODMASTER II	358 RODMASTER II	358 RODMASTER II	247 DUAL ROD HOLDER
WEIGHT STORAGE HOOK	✓	✓	✓	SOLD SEPARATELY	SOLD SEPARATELY	SOLD SEPARATELY	✓	✓
STAINLESS STEEL BOOM LENGTH	36" - 60" TELESCOPIC	36" - 60" TELESCOPIC	36" - 60" TELESCOPIC	24" FIXED	30" FIXED	36" - 60" TELESCOPIC	36" - 60" TELESCOPIC	36" - 60" TELESCOPIC

LIMITED ★★★★★  
**LIFETIME WARRANTY**

	HIGH PERFORMANCE			DEPTHPOWER		
	12lb.	15lb.	20lb.	7 lb.	10lb.	15lb.
Weight	12lb.	15lb.	20lb.	7 lb.	10lb.	15lb.
Retrieval Speed	304 ft./min.	295 ft./min.	260 ft./min.	235 ft./min.	222 ft./min.	203 ft./min.
Amperage Draw	13 amps	14.5 amps	19.5 amps	4 amps	5 amps	8 amps

## MANUAL DOWNRIGGER SPECS













	MANUAL			COMPACT			LAKETROLLER	
	1080 STRONGARM	1085 STRONGARM	1091 LONGARM COMBO PACK	1050 DEPTHMASTER	1050MP MASTERPACK	1060 DEPTHKING	1071 CLAMP MOUNT	1073 BRACKET MOUNT
PREMIUM 150 LB. TEST STAINLESS STEEL CABLE	200 ft.	200 ft.	200 ft.	200 ft.	200 ft.	200 ft.	100 ft.	100 ft.
LOCKING TILT-UP MOUNT	✓	✓	✓	N/A	N/A	N/A	N/A	N/A
POWER GRIP PLUS LINE RELEASE MODEL NUMBER	1170	1170	1170	1170	1170	1170	1181 Mini Grip	1181 Mini Grip
ROD HOLDER MODEL	355 RODMASTER II	358 RODMASTER II	358 RODMASTER II	355 RODMASTER II	355 RODMASTER II	355 RODMASTER II	N/A	N/A
WEIGHT STORAGE HOOK	SOLD SEPARATELY	SOLD SEPARATELY	SOLD SEPARATELY	N/A	N/A	N/A	N/A	N/A
STAINLESS STEEL BOOM - LENGTH	24" FIXED	30" FIXED	36" - 60" TELESCOPIC	23" FIXED	23" FIXED	23" FIXED	12" FIXED	12" FIXED
LARGE SURFACE AUTOMATIC BRAKE	✓	✓	✓	✓	✓	✓	MANUAL DRAG BREAK	MANUAL DRAG BREAK
SPRAY PROTECTED POSITIVE-DRIVE DEPTH COUNTER	✓	✓	✓	✓	✓	✓	N/A	N/A
SPOOL DIAMETER FT. PER TURN	2 ft.	2 ft.	2 ft.	1 ft.	1 ft.	2 ft.	1 ft.	1 ft.



# High Performance

Scotty High Performance Electric Downriggers have reached the highest performance and reliability standards yet, while remaining competitively priced. Thousands of anglers now enjoy the superior speed, power and years of reliability that only Scotty offers. Scotty's custom designed marine components and final quality control tests produce a Downrigger that is unmatched in the industry.

## FEATURES INCLUDED WITH ALL HIGH PERFORMANCE MODELS

-  **Line Release**  
Power Grip Plus 18" (1170)
-  **Rod Holder**  
Rocket Launcher (469)
-  **Mounts**  
Tilt-up Mounting Bracket (1023)  
  
Swivel Mount (1026)  
  
Right Angle Marinco® Receptacle Mount (2128)
-  **Auto Stop** (1121)
-  **Auto Stop Beads**
-  **Weight Storage**  
Storage Hook (1148)
-  **Power Source**  
Marinco® 12V Plug & Receptacle (2125)  
  
Power cord length, 40"
-  **Downrigger Cable/Line**  
300 ft. of 180 lb. test stainless steel cable, 300 ft. of 250 lb. test braided line (2106B model)
-  **Counter**  
Digital Illuminated LCD (2132)
-  **Factory & Field Tested**
-  **Fully Assembled**
-  **Warranty**  
Limited Lifetime

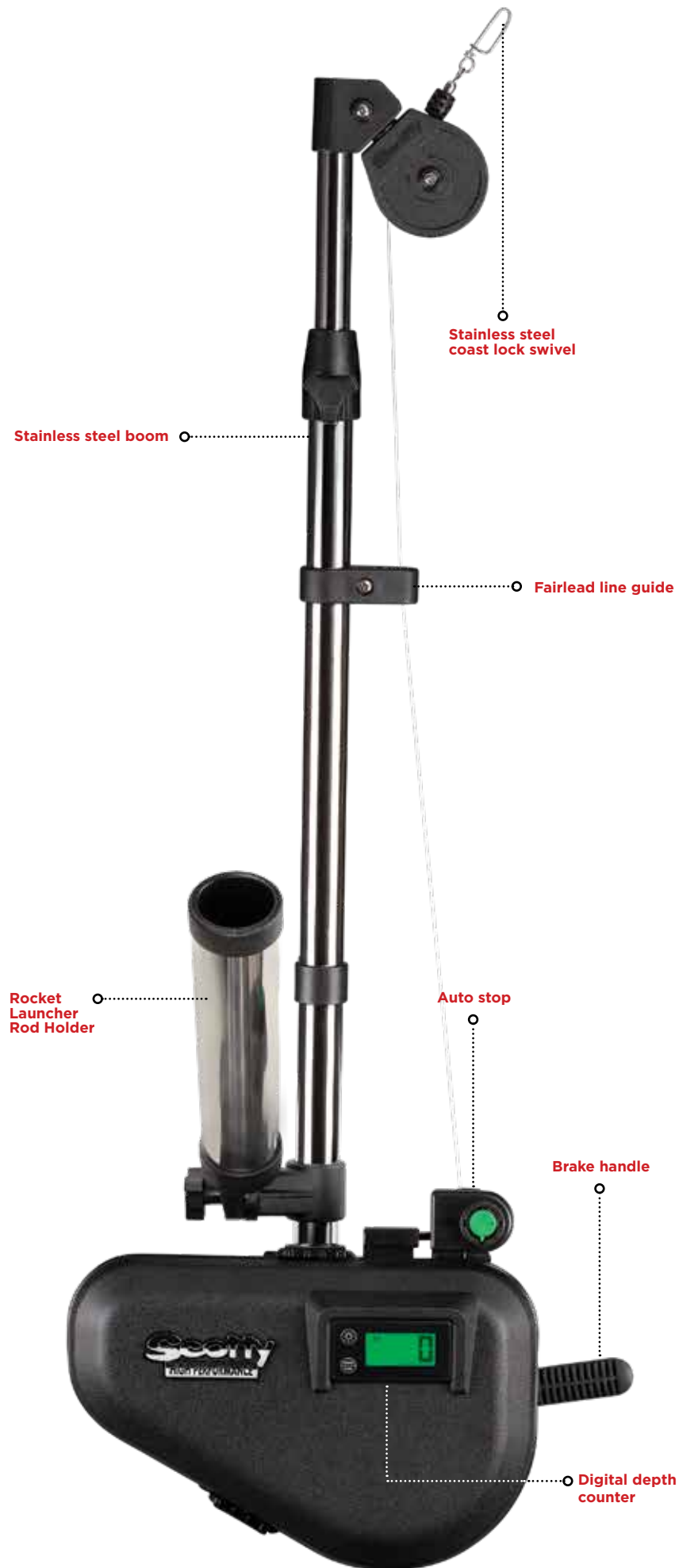

**2106 HIGH PERFORMANCE**  
The Downrigger of choice for serious fishermen. Unmatched in power, performance and reliability. Equipped with 300 ft. of 180 lb. test stainless steel cable. 36"-60" 1 1/4" telescopic stainless steel boom.



**2106B HIGH PERFORMANCE**  
Power and performance packaged with our strongest braided Downrigger line. Equipped with 300 ft. of 250 lb. test braided line. 36"-60" 1 1/4" telescopic stainless steel boom.



**2116 HIGH PERFORMANCE PROPACK**  
The number one choice in performance Downriggers for the charter captain. Equipped with 300 ft. of 180 lb. test stainless steel cable and our stainless steel rocket launcher dual rod holders. 36"-60" 1 1/4" telescopic stainless steel boom.





# Depthpower

Scotty Depthpower Electric Downriggers have the highest performance and reliability standards ever, while remaining competitively priced. Thousands of fishermen now enjoy the superior speed, power and years of reliability that only Scotty offers. From custom designed marine motors to the final quality control tests, Scotty performance is unmatched in the industry.

## FEATURES INCLUDED WITH ALL DEPTHPOWER MODELS

 **Line Release**  
Power Grip Plus 18" (1170)

 **Rod Holder**  
Rod Master II (358)

 **Mounts**  
Tilt-up Mounting Bracket (1023)

Swivel Mount (1026),  
(except 1099 model)

Right Angle Marinco® Receptacle Mount (2128)

 **Auto Stop** (1121)

 **4 Auto Stop Beads**

 **Weight Storage**  
Storage Hook (1148)  
(1106B & 1116 only)

 **Power Source**  
Marinco® 12V Plug & Receptacle (2125)

Power cord length, 40"

 **Downrigger**  
250 ft. of 150 lb. test stainless steel cable. 300 ft. of 200 lb. test braided line (1106B model only)

 **Counter**  
Mechanical (1145)

 **Factory & Field Tested**

 **Fully Assembled**

 **Warranty**  
Limited Lifetime



**1099 COMPACT**  
All the performance features in an easy to stow compact size. Equipped with 250 ft. of 150 lb. test stainless steel cable. 24" long, 1" dia. boom.



**1101 DEPTHPOWER**  
Designed for heavy duty use, this unit will handle long hours and heavy weights in tough conditions. Equipped with 250 ft. of 150 lb. test stainless steel cable. 30" long, 1 1/4" dia. boom.



**1106 DEPTHPOWER**  
Our most popular electric Downrigger. Equipped with 250 ft. of 150 lb. test stainless steel cable. 36"-60" long, 1 1/4" dia. telescopic boom.



**1106B DEPTHPOWER**  
All the features you have come to love with our depthpower series. Now available with more options than ever. Equipped with 300 ft. of 200 lb. test braided line. 36"-60" long, 1 1/4" dia. telescopic boom. Included, Downrigger weight storage hook and sure-stop tackle.



**1116 PROPACK**  
The top choice of charter captains. Equipped with 250 ft. of 150 lb. test stainless steel cable. 36"-60" long, 1 1/4" dia. telescopic boom. Heavy duty adjustable dual rod holder included.



Want to protect it?  
Wrap it up!

**3015 DOWNRIGGER COVER**













# Manual

Scotty Manual Downriggers have been the preferred choice of anglers for over forty years. They are engineered with a number of exclusive features contained in no other Downrigger.

## FEATURES INCLUDED WITH ALL MANUAL MODELS

-  **Line Release**  
Power Grip Plus 18" (1170)
-  **Rod Holder**  
Rod Master II (358)
-  **Mounts**  
Tilt-up Mounting Bracket (1023)
-  **Downrigger Cable/Line**  
200 ft. of 150 lb. test stainless steel cable
-  **Counter**  
Mechanical (1146)
-  **Factory & Field Tested**
-  **Fully Assembled**
-  **Warranty**  
Limited Lifetime



**1080 STRONGARM**  
This Downrigger has outstanding features for small and intermediate size boats. Equipped with 200 ft. of 150 lb. test stainless steel cable. 24" long, 1" dia. boom.

**1085 STRONGARM**  
The heavy duty workhorse of the Scotty manual lineup. Excellent for the intermediate size boat. Equipped with 200 ft. of 150 lb. test stainless steel cable. 30" long 1 1/4" dia. boom.

**1091 LONGARM**  
Ideal for big boats. Equipped with 200 ft. of 150 lb. test stainless steel cable. 36-60" long 1 1/4" dia. telescopic boom. Includes 1026 Swivel Mount.













# Compact

The Depthmaster and Depthking models offer more value for the anglers than anything else on the market. The price and operating features of these units beat the competition hands down.

## FEATURES INCLUDED WITH ALL COMPACT MODELS

-  **Line Release**  
Power Grip Plus 18" (1170)
-  **Rod Holder**  
Rod Master II (358)
-  **Mounts**  
Quick Slide Deck Mount (1010)
-  **Downrigger Cable/Line**  
200 ft. of 150 lb. test stainless steel cable
-  **Counter**  
Mechanical (1146)
-  **Factory & Field Tested**
-  **Fully Assembled**
-  **Warranty**  
Limited Lifetime



**1050 DEPTHMASTER**  
The perfect introductory Downrigger. One foot per turn of the spool. 23" long, 3/4" dia. boom.



**1050MP MASTERPACK**  
The perfect clamp on Downrigger. 23" long, 3/4" dia. boom. Includes 1021 portable anodized aluminum clamp mount.





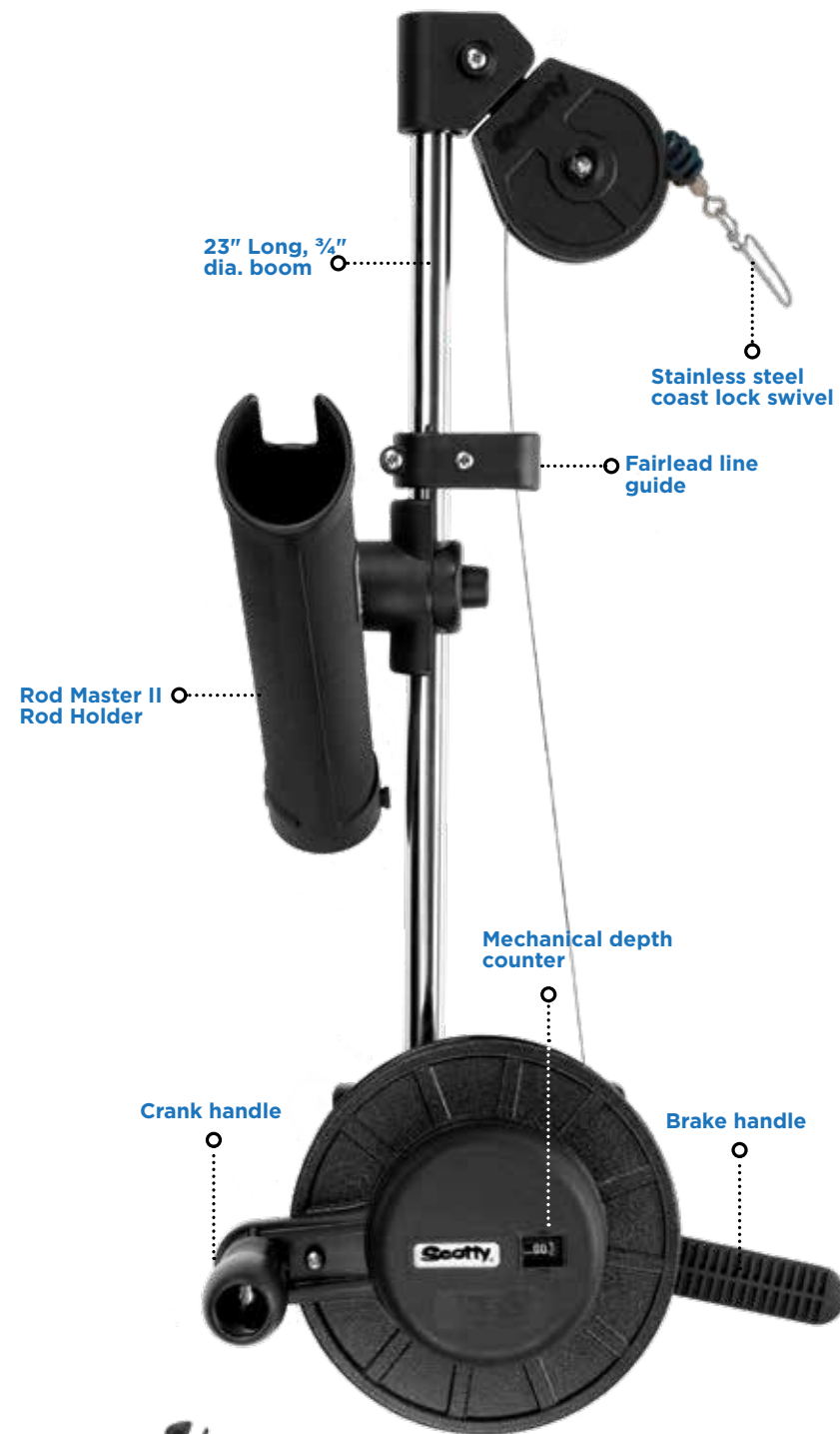

**1060 DEPTHKING**  
Ideal for the small boat that fishes deep and needs a high speed retrieve. Includes a high speed 2 ft. per turn of the spool. 23" long, 3/4" dia. boom.



# Lake Troller

Laketroller Downriggers built for the smaller boat. Great for aluminum boats, kayaks and canoes.

## FEATURES INCLUDED

-  **Line Release**  
Mini Power Grip Plus 18" (1181)
-  **Downrigger Cable/Line**  
100 ft. of 150 lb. test stainless steel cable
-  **Factory & Field Tested**
-  **Fully Assembled**
-  **Warranty**  
Limited Lifetime



**1071 CLAMP MOUNT**  
Comes with fully portable engineering grade modified nylon clamp for mounting on the gunnel or transom (2" opening) Great for aluminum boats and canoes. 1 ft. per turn of the spool. Includes 1181 mini power grip line release.



**1073 BRACKET MOUNT**  
Mounting bracket permits mounting on a flat deck surface or on the side of a gunnel or transom. The mounting design gives 360° of rotation. Comes with a 241 Side Deck mount. 1 ft. per turn of the spool. Includes 1181 mini power grip line release.

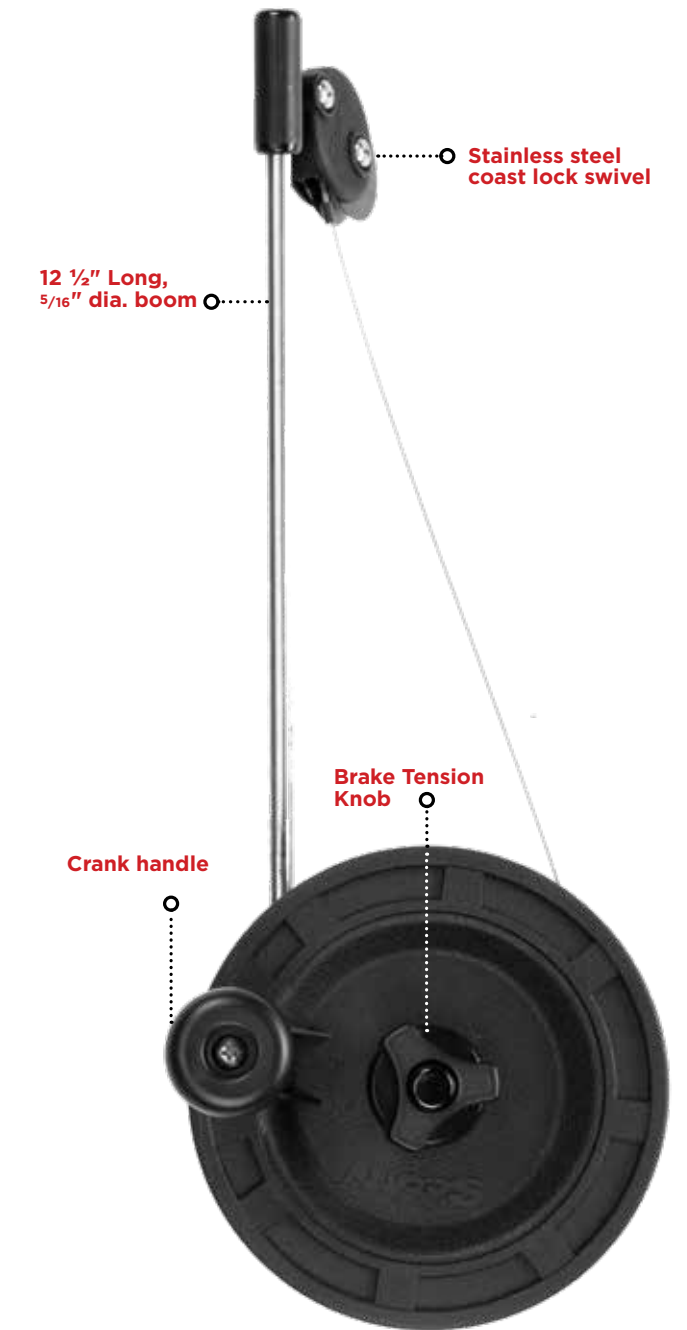



# Downrigger Parts & Accessories



## Downrigger Cable & Line



**1000 SERIES**  
Premium Stainless Steel  
Downrigger Cable



**2400 SERIES**  
High Performance  
Stainless Steel  
Downrigger Cable



**2000 SERIES**  
Heavy Duty Braided  
Downrigger Line



**2700 SERIES**  
Premium Braided  
Downrigger Line



**2800 SERIES**  
Low Drag Braided  
Downrigger Line



**1000 SERIES**

Premium Stainless Steel Downrigger Cable

**150 lb. TEST**

- 1000** 200 ft.
- 1001** 300 ft.
- 1002** 400 ft.
- 1000K** 200 ft. with terminal tackle
- 1001K** 300 ft. with terminal tackle
- 1002K** 400 ft. with terminal tackle

**2400 SERIES**

High Performance Stainless Steel Downrigger Cable

**180 lb. TEST**

- 2400K** 200 ft. with terminal tackle
- 2401K** 300 ft. with terminal tackle
- 2402K** 400 ft. with terminal tackle

**2200 SERIES**

Heavy Duty Braided Downrigger Line

**250 lb. TEST**

- 2200K** 200 ft. with terminal tackle
- 2201K** 300 ft. with terminal tackle
- 2202K** 400 ft. with terminal tackle

**2700 SERIES**

Premium Braided Downrigger Line

**200 lb. TEST**

- 2700K** 200 ft. with terminal tackle
- 2701K** 300 ft. with terminal tackle
- 2702K** 400 ft. with terminal tackle

**2800 SERIES**

Low Drag Braided Downrigger Line

**150 lb. TEST**

- 2800K** 200 ft. with terminal tackle
- 2801K** 300 ft. with terminal tackle
- 2802K** 400 ft. with terminal tackle



# Downrigger Parts & Accessories



**1140** FAIRLEAD FOR ¾" DOWNRIGGER BOOM  
**1141** FAIRLEAD FOR 1" DOWNRIGGER BOOM  
**1149** FAIRLEAD FOR 1¼" DOWNRIGGER BOOM



**1035** 1" REPLACEMENT MOUNTING BOLTS (2 pcs)  
**1135** 2" REPLACEMENT MOUNTING BOLTS (2 pcs)



**1034** 4½" DOWNRIGGER MOUNTING BOLT (2000 models and earlier)  
**1134** 6" DOWNRIGGER/LINE PULLER MOUNTING BOLT (2001 Downrigger models and later)



**1146** MANUAL COUNTER WITH BASE



**1145** DEPTHPOWER COUNTER WITH BASE



**2132** HIGH PERFORMANCE DIGITAL COUNTER



**1147** DOWNRIGGER WEIGHT HOOK For 1" boom.  
**1148** DOWNRIGGER WEIGHT HOOK For 1¼" boom.



**1142** MANUAL DOWNRIGGER HANDLE



**3134** DOWNRIGGER LOCKING PLATES For electric or manual downriggers (3 pcs) (locks sold separately)



**1024** MANUAL COUNTER COVER



**1131** DEPTHPOWER REPLACEMENT LID



**2131** HIGH PERFORMANCE REPLACEMENT LID WITH DIGITAL COUNTER



**1017** DOWNRIGGER LEAD WEIGHT 3 lb. finned.



**1139** DOWNRIGGER PULLEY UPGRADE  
**1014** DOWNRIGGER PULLEY REPLACEMENT KIT



**3022** WEIGHT MATE Holds your Downrigger weights securely. (2 pcs)  
 ○●

## Power Accessories



**1125** HELLA ELECTRIC PLUG AND SOCKET Maximum 12 volt 18 amp applications.  
**1126** HELLA ELECTRIC SOCKET  
**1127** HELLA ELECTRIC PLUG



**1133** 12 FT. PREMIUM TINNED COPPER 12 GAUGE 2 CONDUCTOR POWER WIRE



**1124** 30 AMP MARINE IN-LINE FUSE HOLDER Fuse included.



**1158** DEPTHPOWER DOWNRIGGER SPARE PARTS KIT  
**1159** HIGH PERFORMANCE DOWNRIGGER SPARE PARTS KIT



**SPARE DRIVE BELTS**  
**1128** For 2 belt Depthpower Downriggers, 2000 models and earlier, dual belt model.  
**1129** For 1 belt Depthpower Downriggers, 2001 models and later.  
**2129** For High Performance Downriggers and Line Puller (2500)



**1132** EMERGENCY CRANK HANDLE For Electric Downriggers.



**2127** MARINCO® 12V DOWNRIGGER PLUG



**2126** MARINCO® 12V DOWNRIGGER RECEPTACLE  
**2125** MARINCO® 12V DOWNRIGGER PLUG AND RECEPTACLE (2127/2126)



**2128** RIGHT ANGLE RECEPTACLE MOUNT For Marinco® Downrigger Receptacle.



# Downrigger Parts & Accessories

## DOWNRIGGER TACKLE



**2008** (6 pcs)  
**2008-24** (24 pcs)  
**AUTO STOP BEADS**  
For braided line.

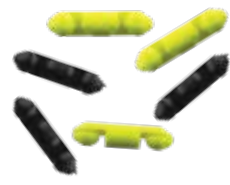

**1008**  
**STOPPER BEADS**  
For stainless steel cable  
(3 yellow & 3 black)



**1008-24-BK** (24 pcs)  
**1008-24-YL** (24 pcs)  
**STOPPER BEADS**  
For stainless steel cable.



**1004**  
**CONNECTOR SLEEVES**  
(10 pcs)



**1157**  
**STAINLESS STEEL THIMBLE SET**  
(2 pcs)



**1154**  
**TERMINAL TACKLE**



**1150**  
**225 LB. TEST COASTLOCK SNAPS**  
(2 pcs)



**1151**  
**350 LB. TEST COASTLOCK SNAP WITH SAMPO® SWIVEL**



**1152**  
**350 LB. LARGE COASTLOCK SNAPS**  
(2 pcs)



**1153**  
**TERMINAL TACKLE**



**1011**  
**DOUBLE LINE CONNECTOR SLEEVES**  
(10 pcs)



**1007**  
**RELEASE CLIP LOCATORS**  
(10 pcs)



**1038**  
**CABLE COUPLER**



**1039**  
**SOFT STOP BUMPERS**  
For snap hooks (4 pcs)



**1009**  
**INSULATING DOWNRIGGER WEIGHT SWIVEL HOOKS**  
(2 pcs)



**373**  
**DIVER SNUBBER** (2 pcs)



**1161**  
**DUMMY FLASHER RIG** (2 pcs)



**1156**  
**3" SELF LOCATING SNAP**  
Stainless steel (2 pcs)



**370** TROLLING SNUBBER  
With Ball bearing swivel and Self Locating Snap.  
**371** TROLLING SNUBBER  
With Self Locating Snap.



**374**  
**SURE STOP ELECTRIC DOWNRIGGER STOPPER SYSTEM**  
For 30 & 60" Downrigger booms.



**3025**  
**DOWNRIGGER WEIGHT RETRIEVER**  
A safety precaution for the Downrigger fisherman. Brings your weight in for rigging lines and releases without having to lean out over the gunnel.

## SURE STOP PRO FOR ELECTRIC DOWNRIGGERS

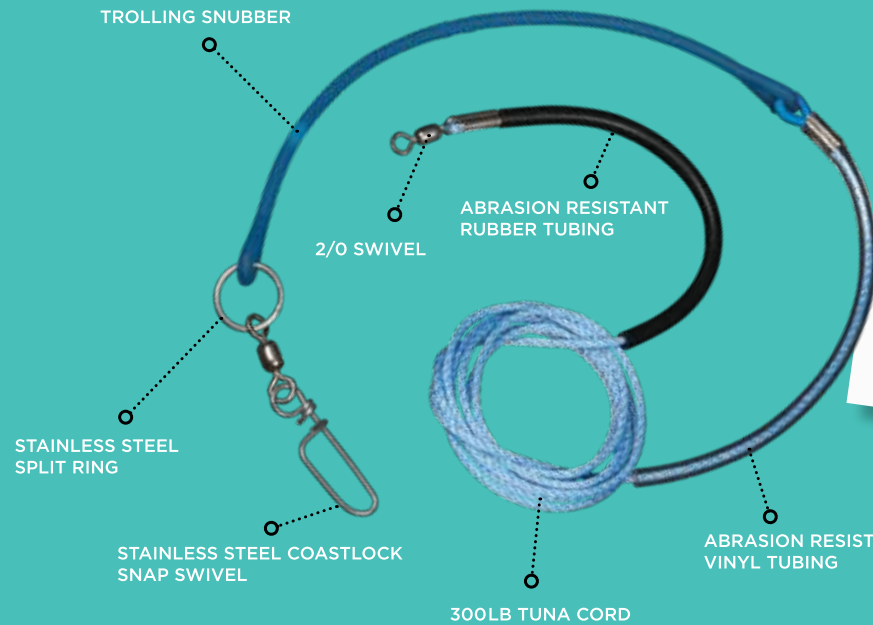

**375** for 30" boom.  
**376** for 60" boom.



**377** for 30" boom with Snubber.  
**378** for 60" boom with Snubber.





# Line Releases

Fishing line is gripped between the soft pads and variable release tension is attained by moving the line in or out of the jaws. The "tension adjuster" doubles the holding power if needed. Streamlined design won't snag on weeds or foul lines.



1. Attach to your Downrigger Cable or Cannonball.
2. Attach your fishing line to the Power Grip release by squeezing the jaws apart and placing your fishing line between the pads. The release tension is lighter at the outer tip, and is heavier the further into the jaws you place the line.
3. The tension adjuster can be moved forward to decrease or back to increase the release tension.

## POWER GRIP PLUS

**1170** 18"  
**POWER GRIP PLUS**  
Monofilament leader with Cannonball Snap.



**1171** 18"  
**1172** 30"  
**1173** 48"  
**1178** 60"  
**POWER GRIP PLUS**  
Monofilament leader with Self Locating Snap.



**1176** 6"  
**1179** 30"  
**1191** 48"  
**1192** 60"  
**POWER GRIP PLUS**  
Stacker with monofilament leader and Cannonball Snap.



**1177**  
**POWER GRIP PLUS**  
Planer Board Snap.



## MINI POWER GRIP PLUS

**1181** 18"  
**MINI POWER GRIP PLUS**  
Wire leader with Cannonball Snap.



**1180** 18"  
**1183** 30"  
**MINI POWER GRIP PLUS**  
Wire leader with Self Locating Snap.



**1182**  
**MINI POWER GRIP PLUS**  
Planer Board Snap (4 pcs)



**1190**  
**POWER GRIP PLUS PADS**  
(6 pcs)



## SNAPPER

**1041** 18"  
**1049** 30"  
**1040** 48"  
**SNAPPER RELEASE CLIP**  
Monofilament leader with Self Locating Snap.



**1042** 18"  
**SNAPPER RELEASE CLIP**  
Monofilament leader with Cannonball Snap.



**1043**  
**SNAPPER RELEASE CLIP**  
Planer Board Snap.



**1045** 7"  
**SNAPPER RELEASE CLIP**  
Wire leader with Cannonball Snap.



**1160** 6"  
**SNAPPER RELEASE CLIP**  
Stacker with monofilament leader and Cannonball Snap.



## HAIRTRIGGER

**1020**  
**HAIRTRIGGER RELEASE CLIP**  
Release clip attaches directly to the Downrigger line. Simple and effective.



**1005**  
Original Style Downrigger Release.



**1006**  
Extra Pins for Original Style Downrigger Release (3 pcs)



**1022**  
Extra pins for hairtrigger release clips (3 pcs)

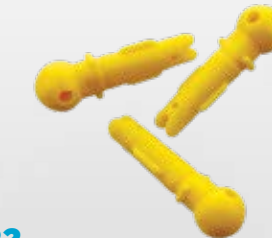

## MINI SNAPPER

**1046** 18"  
**MINI SNAPPER RELEASE CLIP**  
Monofilament leader with Self Locating Snap.



**1047** 18"  
**MINI SNAPPER RELEASE CLIP**  
Monofilament leader with Cannonball Snap.



**1048**  
**MINI SNAPPER RELEASE CLIP**  
Planer Board Snap (4 pcs)





# Line Puller

High torque 12 volt motor pulls 1 crab trap or 4 prawn traps. 120 fpm retrieval speed. 19 amp draw at 50 lbs. Accommodates 1/4" - 3/8" line. Compact size makes for easy stowing. Heavy duty stainless steel and composite construction. Easy access on/off switch. Scotty/Marinco® plug, receptacle and mount included. 40" power cable length. For recreational use only.

## FEATURES INCLUDED WITH LINE PULLER

-  **Mounts**  
Non-tilting Mounting Bracket
-  **Power Source**  
Marinco® 12V Plug & Receptacle (2125)
-  **Power Cord**  
length 40"
-  **Ampage Power**  
19 amp draw at 50 lbs.
-  **Factory & Field Tested**
-  **Fully Assembled**
-  **Warranty**  
2 year



**2515**  
**LINE PULLER STOW-AWAY BAG**  
This durable stow-away bag protects your Scotty Line Puller from the elements when not in use.



**2500**  
**LINE PULLER**  
The ultimate crab and prawn trap pulling machine. 12" stainless steel boom.



**Trap-Ease**  
Crab and prawn trap roller for easy retrieval. Fits all Scotty post mounts.



**749**  
**TRAP-EASE** No mount.

**750**  
**TRAP-EASE** 241 Side Deck Mount.

Don't forget to check out our large selection of Bait Jars on page 55



# Rod Holders

ORCA

The inner sleeve opens in one smooth motion allowing your rod to be released in an instant. With one quick motion, your fishing rod is lifted straight out into the fish fighting position.



**400**  
241L Locking Side Deck Mount.



**SMOOTH EASY OPEN ACTION**



**LOCKING TAB TO PREVENT ROD LOSS WHILE TRAVELING**



**401**  
244L Locking Flush Deck Mount.



**405**  
459 Double Ended Extender.

All post mount Scotty Rod Holders are fully adjustable and interchangeable.





# Rod Holders

## STRIKER

Designed and built tough for Salmon, Muskie, Halibut, Sturgeon, and other big game fish. Stainless steel reinforced post with an oversized opening and easy lock/unlock collar. The inner support rotates with the rod to instantly remove and strike simultaneously.

### LOCKING COLLAR



UNLOCKED



LOCKED



**239**  
No mount.



**240**  
241 Side Deck Mount.



**246**  
244 Flush Deck Mount.





# Rod Holders

## POWER LOCK

Scotty's most popular value-priced, positive-locking, open style rod holder. Universal cradle holds almost any reel type. Fibre reinforced engineering grade nylon provides strength, resilience and reliability.

**229**  
No mount.



**230**  
241 Side Deck Mount.  
○○●



### LOCKING COLLAR



UNLOCKED



LOCKED

**330**  
259 Height Extender and 241 Mount.



**231**  
244 Flush Deck Mount.  
○○●



**256**  
Triple with 257 and 241 Mounts.

**339**  
449 Clamp and 241 Mount.  
(maximum clamp opening 2")





# Rod Holders

## ROD MASTER



**250**  
241 Side Deck Mount.



**251**  
244 Flush Deck Mount.



**255**  
Fits 3/4" and 1" Scotty Downrigger booms.



**469**  
No mount.



**470**  
241L Locking Side Deck Mount.



**471**  
244L Locking Flush Mount.

## ROD MASTER II



**258**  
Fits 1 1/4" Scotty Downrigger boom.



**350**  
241 Side Deck Mount.



**351**  
244 Flush Deck Mount.



**473**  
344 Round Flush Deck Mount.



**477**  
244 Flush Mount.



**476**  
241 Side Deck Mount.



**349**  
No mount.



**355**  
Fits 3/4" and 1" Scotty Downrigger booms.



**358**  
Fits 1 1/4" Scotty Downrigger boom.



**478**  
344 Round Flush Deck Mount.



**479**  
No mount.



**222**  
**SIDEWINDER**  
5/16" stainless steel construction.  
237 Triggerlock Mount Included.

**223**  
**SIDEWINDER**  
no mount (not shown)

## ROCKET LAUNCHER

## SIDEWINDER



# Rod Holders

## BAITCASTER SPINNING

Holds a bait caster reel securely in the cushioned cradle. A slot in the front of the rod holder allows for secure holding of a spinning reel. This rod holder is designed with a side mounted flange which leaves the bottom open, this allows for the rod holder to accommodate trigger grips. Rods can be secured with a soft latching strap which snaps over the top for baitcaster or under the bottom for spinning reels.



**284**  
243 1/4" Square Rail Mount.



**389**  
449 Clamp and 241 Mounts.  
Maximum clamp opening 2".



**279**  
No mount.



**281**  
244 Flush Deck Mount.



**282**  
438 Gear Head and 440-4 Track.



**280**  
241 Side Deck Mount.  
○○●



**388**  
429 Gear Head Mount  
Extender and 241 Mount.





# Rod Holders

## FLY ROD

Innovative compact design allows for hands free trolling with a Fly Rod. Your rod can be secured in the rod holder with the soft latching strap which snaps over the top. Works well with "short butt" fly rods. All post mount Scotty Rod Holders are fully adjustable.



**260**  
No mount.



**265**  
241 Side Deck Mount.



**264**  
244 Flush Deck Mount.



**267**  
241 and 266 Float Tube Mounts.





# Mounts



## ELECTRONIC MOUNTS



**368**  
**UNIVERSAL SOUNDER FISHFINDER MOUNT**  
This uses a multi pattern universal top plate and the post mount design for quick removal and adjustable rotation.



**268**  
**FLOAT TUBE FISHFINDER MOUNT**  
Adapt a fishfinder to your float tube or pontoon boat. Includes transducer bracket and 6' strap.



**135**  
**CAMERA MOUNT**  
This mount is fully twistable, turnable, rotatable and best of all, instantly portable. Locks down a sport or standard camera without needing a special adapter.



**272**  
**SWIVEL FISHFINDER MOUNT**  
Mount only.



**269**  
**SWIVEL FISHFINDER MOUNT**  
241 Side Deck Mount.



**270**  
**SWIVEL FISHFINDER MOUNT**  
244 Flush Deck Mount.

## Transducer Mounts

Designed for kayaks and small boats. Made from high strength composite materials. Adjustable arms allow for multiple depths and angles. Collapses easily for storage. 415 slip disks for micro adjustments.



**140**  
**TRANSDUCER ARM**  
412 Post and 241 Side Deck Mount.

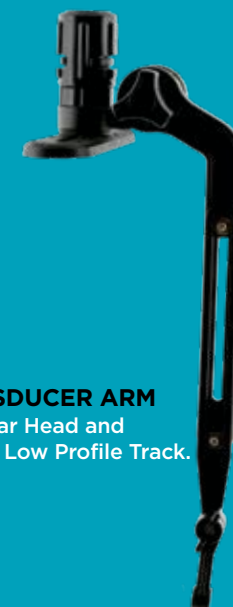

**141**  
**TRANSDUCER ARM**  
438 Gear Head and 440-4" Low Profile Track.





# Mounts

## BALL MOUNTS

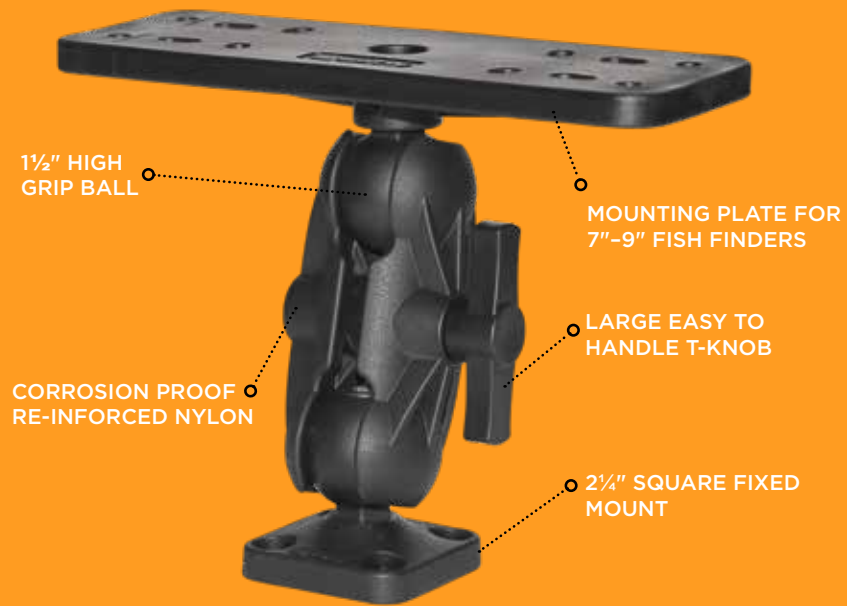

**163**  
1 1/2" BALL MOUNT  
Fish Finder & Universal Mounting Plate



**162**  
1 1/2" BALL MOUNT  
Gear Head, post & Side Deck Mount



**150**  
1" BALL MOUNT  
Universal Mounting Plate



**151**  
1" BALL MOUNT  
Gear Head & track



**152**  
1" BALL MOUNT  
Gear Head, post & Side Deck Mount

The ball mounting system design enables a smooth, full range of motion. The corrosion proof construction provides a long service life in both fresh and salt water applications. The Gear Head's effortless drop and lock system allows for secure and re-position post mount accessories with just a twist. The 163 top plate has been designed to accept large fish finders.





# Mounts

## POST MOUNTS



**241**  
**SIDE DECK MOUNT**  
Can be mounted on top or side of your gunnel. ○○○



**241L**  
**LOCKING SIDE DECK MOUNT**  
A 241 mount with an easy to use lock and unlock push button system.



**344**  
**ROUND FLUSH DECK MOUNT**  
Sealed base for watertight applications.

## ADAPTERS



**237**  
**TRIGGERLOCK**  
Designed for 222 Sidewinder Rod Holder and 1015 Right Angle Mount.



**238**  
**RAIL MOUNT ADAPTER**  
Works in conjunction with 237 Triggerlock Mount (7/8" and 1" round rails)



**441**  
**BACKING PLATE**  
Adds structural support when attaching a Side Deck or Flush Deck Mount to a thin-walled watercraft.



**444**  
**COMPACT THREADED DECK MOUNT**  
Use on gunnels up to 2" thick. Base cap for water tight applications.



**244**  
**FLUSH DECK MOUNT**  
Sealed base for watertight applications. ○○○



**244L**  
**LOCKING FLUSH DECK MOUNT**  
Locks and unlocks your post mount product easily by sliding a lever.



**242**  
**RAIL MOUNT ADAPTER**  
Works in conjunction with 241 Side Deck Mount (7/8" and 1" round rails) ○○○



**340**  
**TRACK ADAPTER**  
Convert your 3 1/2" track into a Scotty Post Mount. Scotty Side Deck Mount required.



**423**  
**DOWNRIGGER ROD HOLDER ADAPTER**  
Convert your 1023 tilt-up mounting bracket into a rod holder mount. Scotty Side Deck Mount required.



**243**  
**1/4" SQUARE RAIL MOUNT**



**245**  
**1/4" ROUND RAIL MOUNT**



**287**  
**7/8" ROUND RAIL MOUNT**



**248**  
**OARLOCK MOUNT**  
Use the oarlock mount on your row boat to mount any Scotty post mount rod holder or accessory.



**449**  
**CLAMP MOUNT**  
Fully portable mounting option for all Scotty post mount rod holders and accessories, maximum clamp opening 2".



**433**  
**COAMING/GUNNEL CLAMP MOUNT**  
Position your rod holder or accessory virtually anywhere on the lip of your kayaks coaming or boat gunnel, maximum clamp opening 1 1/2".

## TRIPLE MOUNTING SYSTEM

Designed to be a multi-functional rod holder or accessory platform for any watercraft.



**257**  
**TRIPLE MOUNT**  
241 Side Deck Mount.



**362**  
**TRIPLE MOUNT**  
Fixed Mount.





# Mounts

## DOWNRIGGER MOUNTS



**1027 RAIL MOUNT**  
Fits up to 1 1/2" round rails, including oval-shaped wooden rails. Transfers the downward pressure to the boat gunnel. Fits all Scotty Downriggers (except Laketrollers) and can be used with 1026 Swivel Mount.  
**Dimensions: 6 1/8" x 7 7/8"**



**1036 MOUNTING PLATE**  
Extra mounting plate for 1026 Swivel Mount and 2606/2612 Pedestal Risers.  
**Dimensions: 5 1/2" x 5 1/2"**  
**Bolting dimensions: 4 1/2" x 3 1/2"**



**1037 MOUNTING PLATE**  
Extra mounting plate for 1025 Right Angle Side Gunnel Mount.  
**Bolting dimensions: 2" x 4" (side plate)**



**2027 STANCHION MOUNT**  
The Scotty Stanchion Mount enables you to quickly mount a Downrigger to your boats railing stanchion for extra stability. Fits all Scotty Downriggers (except Laketrollers) and can be used with 1026 Swivel Mount.  
**Dimensions: 6" x 6" x 6" (top plate)**  
**Bolting Dimensions: 2" x 4" (side plate)**



**1028/1029 GIMBAL MOUNT - 9" GIMBAL MOUNT - 12"**  
Made from welded stainless steel for strength and durability. For use in factory mounted gimbal rod holders only. Fits all Scotty Downriggers (except Laketrollers) and can be used with 1026 Swivel Mount.  
**Dimensions: 1028 6 1/8" x 7 7/8" (top plate) 9" x 1 1/2" dia. (gimbal)**  
**1029 6 1/8" x 7 7/8" (top plate) 12" x 1 3/4" dia. (gimbal)**



**2606/2612 PEDESTAL RISER - 6" PEDESTAL RISER - 12"**  
Made from 2" stainless steel tubing for the ultimate in strength and durability. Designed to be used with 1026 Swivel Mount, 1023 tilt-up Downrigger mount and 1010 compact Downrigger mount.  
**Plate Dimensions: 5 1/2" x 5 1/2"**  
**Bolting Dimensions: 3 1/2" x 4 1/2"**



**1023 TILT-UP MOUNTING BRACKET**  
Extra mounting bracket for all Scotty tilt-up Downriggers. Also used as the mounting bracket for the Scotty 2500 Line Puller.  
**Dimensions: 2 1/2" x 4 1/2"**  
**Bolting dimensions: 3 3/4" x 1 5/8"**



**1025 RIGHT ANGLE SIDE GUNNEL MOUNT**  
For boats with narrow or uneven gunnels. Fits all Scotty Downriggers (except Laketrollers) and can be used with 1026 Swivel Mount.  
**Dimensions: 6" x 6" x 6" (top plate)**  
**Bolting dimensions: 2" x 4" (side plate)**



**1026 SWIVEL MOUNT**  
Gives a full 360° of rotation with 16 locking positions. Comes with 1036 Mounting Plate. Fits all Scotty Downriggers (except Laketrollers)  
**Dimensions: 5 1/2" x 5 1/2" x 4"**  
**Bolting dimensions: 3 1/2" x 4 1/2"**

## COMPACT DOWNRIGGER MOUNTS



**1021 PORTABLE CLAMP-ON BRACKET**  
Portable mounting option. Great for aluminum boats. Double stainless steel bolts and black anodized aluminum. 2" clamp opening. To be used with 1010 mounting bracket (sold separately)  
**Dimensions: 5 5/8" x 4 3/4" x 3 1/8"**



**1015 SIDE MOUNT BRACKET**  
For boats with narrow or uneven gunnels. Fits 1050 Downriggers. To be used with 1010 mounting bracket (sold separately)  
**Dimensions: 5 1/4" x 2 1/2"**  
**Bolting Dimensions: 4 7/16" x 1 5/8"**



**1010 QUICK-SLIDE DECK MOUNTING BRACKET**  
Works with the 1025 through 1029 optional mounts.  
**Dimensions: 4 3/4" x 5 5/8"**  
**Bolting Dimensions: 2 5/8" x 4 7/8"**

## DOWNRIGGER DUAL ROD HOLDER



**247 DUAL ROD HOLDER**  
Designed for use with the 1026 Swivel Mount.



**347 DUAL EXTENDED ROD MASTER II ROD HOLDER**  
Designed for use with the 1026 Swivel Mount.



**447 DUAL ROCKET LAUNCHER ROD HOLDER**  
Designed for use with 1026 Swivel Mount.





# Mounts

## LOW PROFILE TRACK

Made from corrosion proof high strength composite materials that will last a lifetime. Top load design for quick and easy use. Use the 438 Gear Head Track Adaptor to mount all of your favourite rod holders and accessories.



**Dimensions:**  
7" L x 1 3/4" W x 3/8" H  
**Bolting Dimensions:**  
1 3/4" x 1 1/8"

**440-1**  
1" LOW PROFILE TRACK



**Dimensions:**  
3 1/2" L x 1 3/4" W x 3/8" H  
**Bolting Dimensions:**  
1 3/4" x 1 1/8"

**440-4**  
4" LOW PROFILE TRACK



**Dimensions:**  
10 3/4" L x 1 3/4" W x 3/8" H  
**Bolting Dimensions:**  
1 3/4" x 1 1/8"

**440-8**  
8" LOW PROFILE TRACK



## Gear Head

Quick and easy, drop and lock system. Allows you to secure and reposition your rod holder or accessory with just a twist. Fits all Scotty post mount rod holders and accessories.



**438**  
**GEAR HEAD TRACK ADAPTER**  
Use the Track Adaptor with the 440 Low Profile Track for quick and easy install and removal of your favourite Scotty post mount product.



**426**  
**SIDE SLIDE TRACK ADAPTER**  
Our unique Track Adaptor allows you to securely fasten your favourite post mount product to a side mounted track.



**428**  
**GEAR HEAD MOUNT**  
Use in conjunction with any of our height extenders to bring your rod or accessory closer to you.



# Mounts

GLUE/STICK ON



**342**  
GLUE/STICK ON PADDLE CLIP



**341**  
GLUE ON MOUNT



**445**  
2" GLUE/STICK ON MOUNT  
438 Gear Head.



**448**  
3" GLUE/STICK ON MOUNT  
438 Gear Head.



**348**  
3" GLUE/STICK ON MOUNT



**443**  
3" GLUE/STICK ON MOUNT  
Flexible D-Ring.



**442**  
3" GLUE/STICK ON MOUNT  
309 Cup Holder Button.



**345**  
2" GLUE/STICK ON MOUNT





# Boating & Fishing Accessories



**206**  
4 FT. ALUMINUM LANDING NET  
with 30" hoop.  
**207**  
6 FT. ALUMINUM LANDING NET  
with 30" hoop.  
**215**  
REPLACEMENT NET BAG  
(not shown)



**210**  
NET MINDER  
A quick release and tangle free system for netting fish.



**412**  
REPLACEMENT POST  
The replacement post fits all Scotty post mount rod holders.



**414**  
OFFSET GEARS  
Doubles your rod holder positions for ultimate versatility.



**225**  
24" GAFF  
**226**  
30" GAFF



**415**  
SLIP DISKS  
Allows you to make micro adjustments to your rod holder or any Scotty post mount products.



**302**  
KAYAK STABILIZER  
Over 30 lbs. of extra buoyancy. Our unique design makes installation and removal quick and easy.



# Extensions

## & ADAPTERS

Extend and adapt all of your Scotty post or spline mount rod holders and accessories. Always have your fishing rod within reach and your favourite accessories at the perfect location.



**254**  
height  
extender  
8½" long



**2028**  
gimbal  
mount  
1½" dia.  
9" long



**2029**  
gimbal  
mount  
1¾" dia.  
12" long



**459M**  
mini double  
ended  
extender  
5½" long



**254M**  
mini  
extender  
4¼" long



**429**  
gear head  
mount  
extender



**259**  
height  
extender  
6½" long



**253**  
gimbal  
mount



**459**  
double  
ended  
extender  
9½" long



**453**  
gimbal  
adapter  
gear head





# BAIT BOARD & ACCESSORY TRAY



**135**  
Camera Mount

**990**  
Knife Shapener

**310**  
Cup Holder

**455**  
Bait Board & Accessory Tray

**241**  
Side Deck Mount



**132**  
**EXTRA LONG GRIP MOUNTING RIVETS**  
These structural rivets are an excellent solution for mounting hardware where you don't have access to the back side of a mount (10 pcs)



**133**  
**WELL NUT MOUNTING KITS**  
Securely fasten a multitude of products onto thin walled structures with ease. Available in 4, 16, or 100 pack options. Fasteners included.



**327**  
**FENDER RINGS**  
Use to attach a fender to your Scotty post mounts (2 pcs)



**416**  
**ROD BALANCER/REST**  
Non-resistance approach encourages more efficient and successful strike to hook-sets when fishing.



**425**  
**ROD BUTT CUSHION**  
Universal rod butt tube allowing for simple rod to rod transfer.



**420**  
**REEL E-Z ROD HANDLE**  
Take the strain off of your wrist and back by changing the angle of your arm and the leverage of your fishing rod.

# Bait Jars

Vented lid for optimal scent release but prevents sealice entry. Quick lock threaded lid.

**652**  
Fluorescent red 1/2 L bait jar

**651**  
White 1 L bait jar

**671**  
White 1 L vented bait jar

**657**  
Fluorescent red 1 L bait jar

**650**  
White 1/2 L bait jar

**677**  
Fluorescent red 1 L vented bait jar

**672**  
Fluorescent red 1/2 L vented bait jar

**670**  
White 1/2 L vented bait jar



# Accessories

## BOATING ACCESSORIES



**278**  
ANCHOR LOCK  
Fixed mount.



**276**  
ANCHOR LOCK  
241 Side Deck Mount.

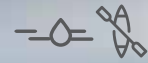

**277**  
ANCHOR LOCK  
244 Flush Deck Mount.

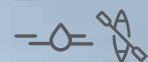

**797**  
ANCHOR KIT  
Anchor Kit for still water use only

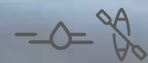

**101**  
OAR COLLARS  
Made from polyethylene. Quick and easy to install. 1 3/4" inside dia. can be trimmed to fit smaller oars (fasteners included)



**102**  
STRONGBACK OARLOCKS  
2 3/4" Standard Oar.  
**104**  
STRONGBACK OARLOCKS  
1 3/4" Small Oar.



**103**  
OARLOCK POSTS  
Adapt your post mount to a 1/2" oarlock socket.



**990**  
KNIFE SHARPENER  
Safe and easy to use. Comes with rotatable carbide blades.



**590**  
Snap Hooks (6 pcs)



**3010**  
Snap Hook Key Chain  
available colours.



**300BK**  
TARP CLIPS Black (4 pcs)  
**300YL**  
TARP CLIPS Yellow (4 pcs)  
Quick and easy to use design with powerful locking jaws for the ultimate hold.  
**301**  
TARP CLIPS BULK/BUCKET  
Black(60 pcs)



**310**  
CUP HOLDER Gunnel mount **A** and **C**  
**311**  
CUP HOLDER Post and Gunnel mount.  
**A, B** and **C**  
**309**  
CUP HOLDER BUTTONS **C** (2 pcs)



**125**  
TUMBLER CUP  
Holds up to 12 oz. dishwasher safe.



# Paddle Sports

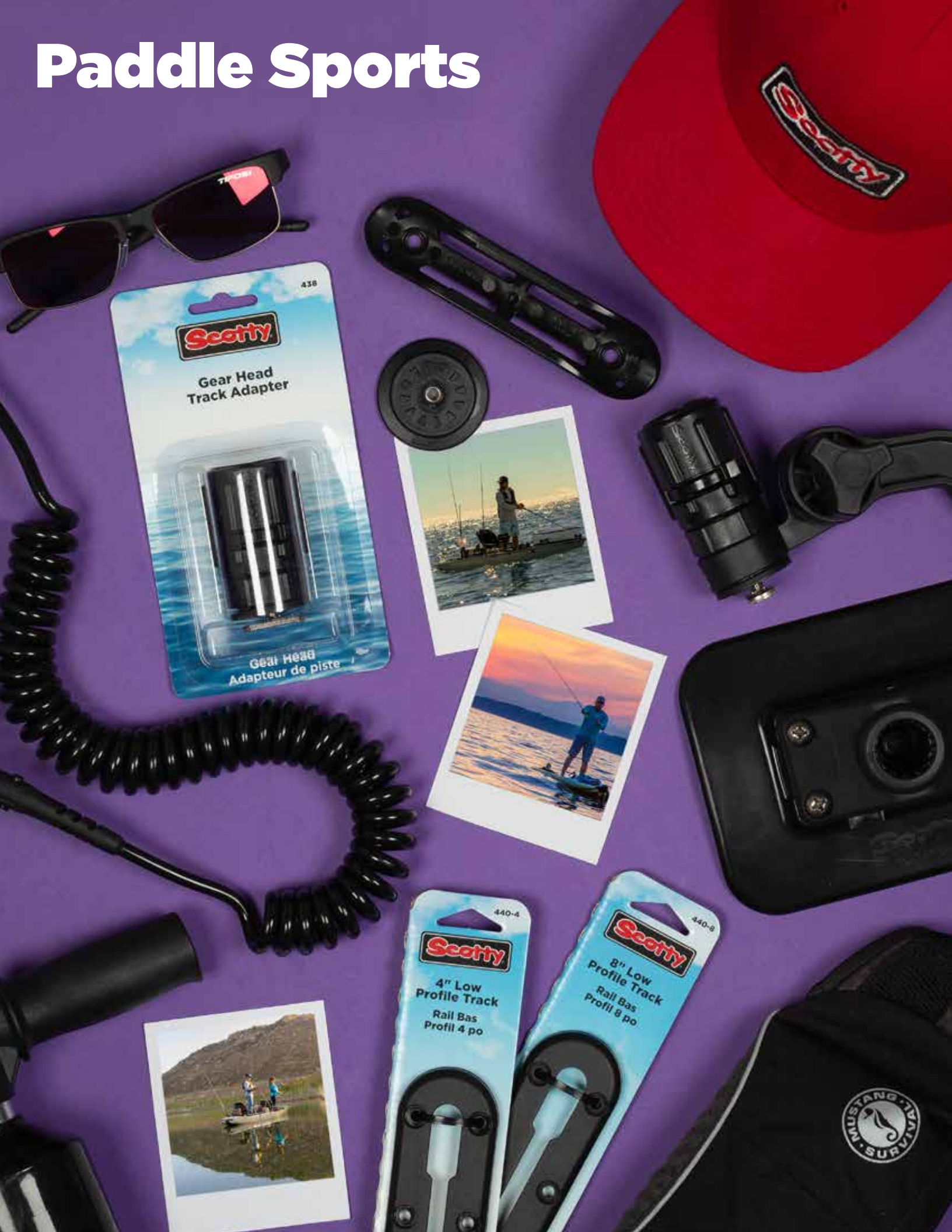

**136**  
PADDLE CLIP



**342**  
GLUE/STICK ON PADDLE CLIP



**130**  
PADDLE LEASH  
Secure your paddle or fishing rod.



**341**  
GLUE-ON MOUNT



**436**  
STAND UP PADDLE BOARD LEASH  
PLUG ADAPTER  
The adapter attaches to your SUP  
pre-installed leash plug with a stainless steel  
J Hook. Accepts all post mount rod holders  
and accessories.



**445**  
2" GLUE/STICK ON MOUNT  
438 Gear Head.





# Paddle Sports

## KAYAK ACCESSORIES

**276**  
Anchor Lock



**455**  
Bait Board & Accessory Tray



**440**  
1" / 4" / 8" Low Profile Track

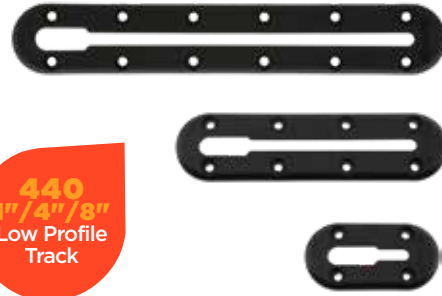

**368**  
Universal fishfinder sounder Mount



**133**  
Well Nuts



**438**  
Gear head track adapter



**282**  
Baitcaster spinning rod holder



**429**  
Gear Head Mount Extender



**257**  
Triple Mount



**797**  
Anchor Kit



**151**  
1" Ball Mount



**163**  
1 1/2" Ball Mount



**162**  
1 1/2" Ball Mount



**150**  
1" Ball Mount



**152**  
1" Ball Mount



**141**  
Transducer Mount



**135**  
Camera Mount



**130**  
Paddle Leash



**311**  
Cup Holder



**835**  
Sea Light



**838**  
Sea Light





# Safety Equipment



**803**  
12V WHITE NAVIGATION LIGHT  
Surface mount.  
**806**  
12V RED NAVIGATION LIGHT  
Masthead base.



**780**  
SAFETY WHISTLE  
**784**  
PEALESS SAFETY WHISTLE



**774**  
WATERTIGHT STORAGE CONTAINER



**789**  
WATERTIGHT FIRST AID KIT  
(not available in the US.)



**130**  
PADDLE LEASH



**793**  
RESCUE THROW BAG



**795**  
WATERTIGHT FLASHLIGHT



**779**  
SMALL VESSEL SAFETY  
EQUIPMENT

# Pumps



**548**  
39" O.A.L.  
HAND  
PUMP

**545K**  
25½" O.A.L.  
KAYAK  
PUMP

**545**  
25½" O.A.L.  
HAND  
PUMP

**544**  
18½" O.A.L.  
HAND  
PUMP

**546**  
PUMP  
FLOAT

**544K**  
18½" O.A.L.  
KAYAK  
PUMP





# Sea-light

ACR detachable, fully sealed LED C-Light™, bright 20 Lumen White LED for location assistance during emergencies. Easy twist ON/OFF activation that is waterproof tested. Impact resistant construction and is USCG/SOLAS approved. C-Light™ is easily removed and can be attached to life jackets, backpacks or hang from a pocket. C-Light™ requires two "AA" 1.5V batteries (batteries not included) C-Light™ has an extensive and continuous operating life for over 30 hours.

## 835 SEA-LIGHT WITH SUCTION CUP MOUNT

A non-permanent safety addition that is perfectly portable for kayaks and small watercraft. Designed to meet the demands of the sea but also ideal for within a vehicle, for camping and whenever a reliable high efficient light is needed. Includes versatile suction cup mount for use in both salt and fresh water.

## 838 SEA-LIGHT WITH POLE & BALL MOUNT

The Scotty Ball System joint design enables a smooth and complete full range of motion for the Sea-Light. The corrosion proof construction of this system provides a long service life in both fresh and salt water applications as it is designed with stainless steel fasteners and a stainless pole. Base Mount Dimensions: 2 ¼ x 2 ¼ Overall Height: Stands 41" tall Sea-Light Pole Diameter: ½".

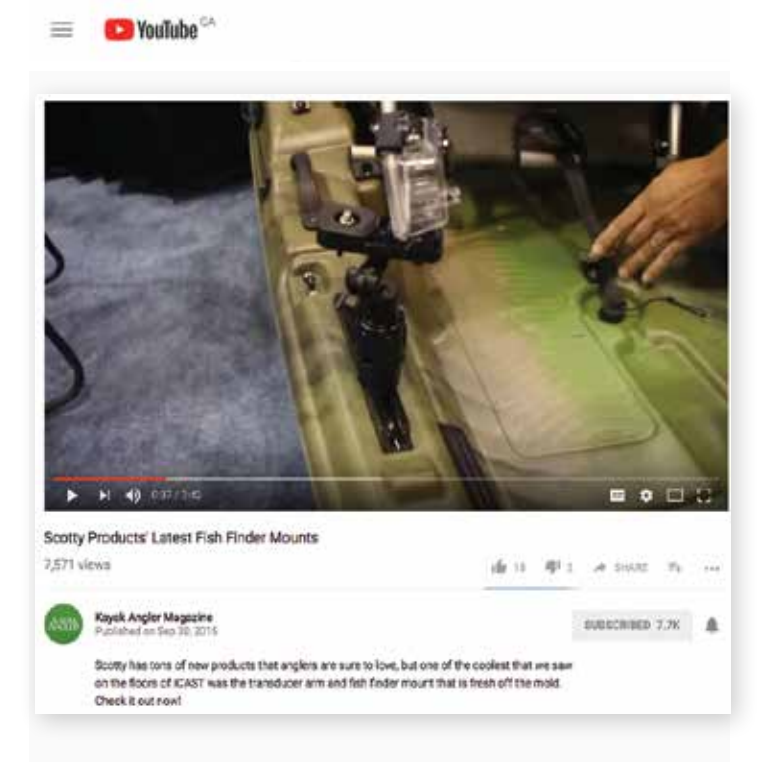
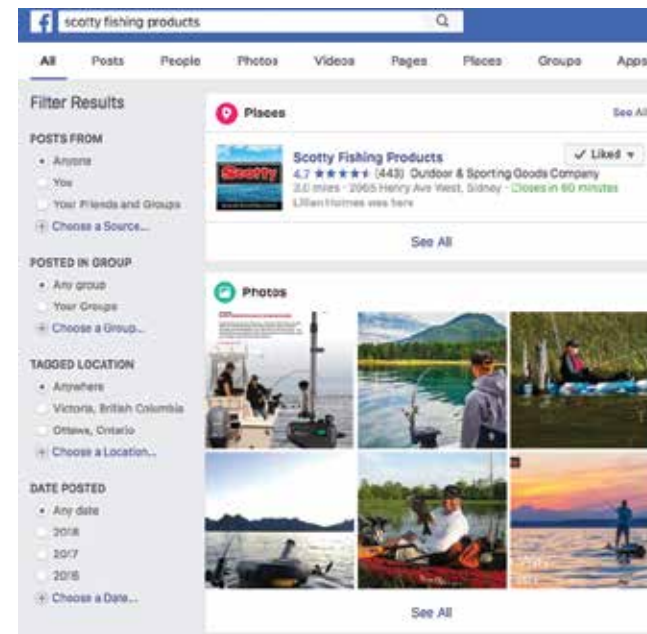
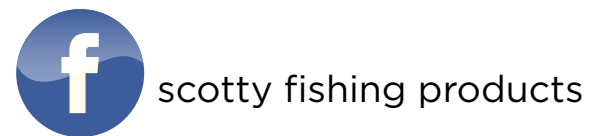



# Jordan-Scotty

## FISH EGG INCUBATOR SYSTEMS

### Purpose

The critical need to enhance our salmon and fish stocks is well documented. Natural spawning has declined dramatically over the past few decades for many reasons. Many of the spawning areas no longer exist. The areas that do still exist are only partially effective and many of our original salmon stocks are now extinct. The need for enhancement programs by volunteers and organizations has never been greater. The availability of the Jordan-Scotty Fish Egg Incubator unit can be of great help for our precious salmon and other fish stocks and their eventual recovery.

The development of the Jordan-Scotty Fish Egg Incubator is the direct result of the desire by Scotty to make a contribution to the enhancement of the salmon, trout and walleye stocks in the streams and creeks around the world. Over the years, due to human interference, these habitats have lost their natural spawning and rearing capabilities. At Scotty, we hope that our efforts will assist bringing the fish back. With your help, future generations will be able to watch fish return to streams and rivers in historic quantities.

**For use by everyone who is interested in enhancing salmon and other fish runs in any stream, river or lake. Perfect for streamkeeper groups, research applications and education projects.**

### History and Design

The original incubator prototype was designed and tested by Mr. Fred Jordan, a Salmonid Technician for many years. He conceived the idea for stream enhancement during the 1980's. The success of his early experiments with this unit led to research, development and further design of the incubator by Scott Plastics Ltd. Sidney, BC. This unit is extremely efficient and very compact. It is simple to use, durable, cost effective and practical, making it an excellent addition to enhancement projects.

The Jordan/Scotty Fish Egg Incubator is a scientifically designed and tested plastic incubation unit and was developed to provide an efficient aid in the stream incubating of fish eggs. The unique design either eliminates or minimizes most of the problems experienced by natural spawning.

Fungus infection is virtually eliminated and eggs are protected from predators and silt suffocation. Testing and usage indicates that survival rates from egg to fry is often better than 65-95% as compared to natural spawning survival rates of between 5-20%.

In nature, high egg loss rates can easily be caused by poor fertilization when deposited eggs not being successfully buried, fungus from dead eggs spreading to healthy eggs, attrition by predators, and silt suffocation. The Jordan-Scotty Fish Incubator addresses these issues and others. Egg quality can be checked during the loading process and all eggs are fertilized before loading. Eggs are quarantined from each other during development, limiting the spread of disease and fungal infection. Eggs are safe from predators and alevin are safely contained until their yolk sac have been absorbed, increasing survival rates.



### How It Works

A pair of loaded plates are bolted together to create a "unit" designed to hold 200 single eggs or more, depending on species and size of egg. The plates are held together by nylon tie bolts and stainless steel nuts and can be grouped in up to 5 unit sets. Escape holes allow the hatched fry to swim free once they have developed in their protected environment. The assembled egg units are anchored in streams by securing them to re-bar stakes or some other permanent holders.

Incubator plates are available with three sizes of escape hole, use to be determined by using our Incubator chart.



### How to Obtain Jordan-Scotty Fish Egg Incubators

These Egg Incubator units are available at a nominal price to cover minimum raw materials and labour costs. Incubators can be purchased from:

**Scott Plastics Ltd. / Scotty Manufacturing**

1-800-214-0141  
incubator@scotty.com



Scan the QR Code to direct you to an information video.



**SCOTTY FISHING & OUTDOOR  
PRODUCTS**

2065 Henry Ave West  
Sidney, British Columbia  
Canada V8L 5Z6

<b>PHONE</b>	250 656 8102
<b>TOLL FREE</b>	1 800 214 0141
<b>FAX</b>	250 656 8126
<b>EMAIL</b>	<a href="mailto:scotty@scotty.com">scotty@scotty.com</a>