



**BOATER'S
GUIDE TO CABIN
VENTILATION**

INSTALLATION INSTRUCTIONS

For the past four decades, Nicro Ventilation has been the pioneer in marine ventilation systems. Back in the 1960's, Nicro's PVC cowl vents began a product evolution process that has resulted in today's line of the most advanced solar powered ventilation products in the world.

Nicro Ventilation makes products that last. Each vent is built to exacting quality standards with the best components available. Your Nicro vent will provide you with many years of ventilation that will maintain your boat's interior, while making your boating experience more comfortable and enjoyable. No more mold, mildew or musty air!

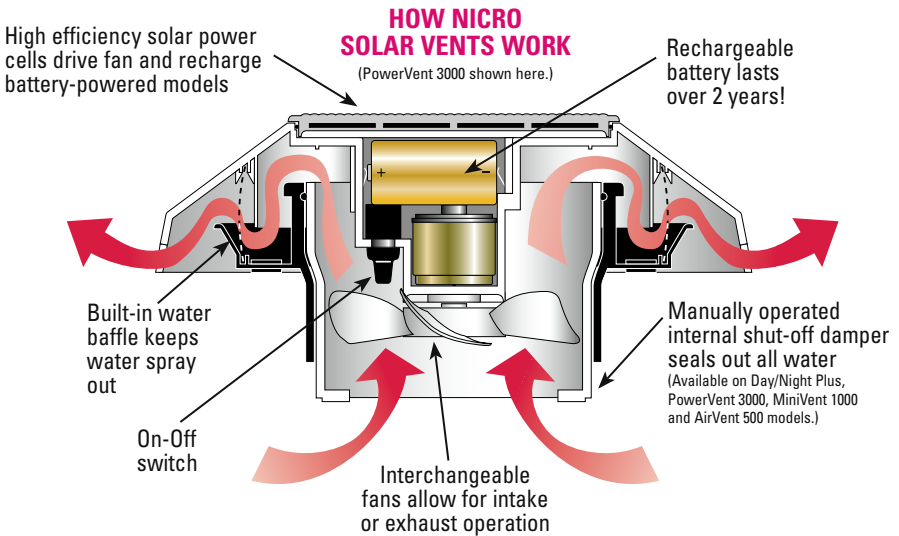

TABLE OF CONTENTS

Why Ventilate?	Pg. 1	PowerVent 3000.....	Pg. 18
Common Ventilation Questions....	Pg. 2	Day&Night 2000.....	Pg. 25
Ventilation Principles	Pg. 3	MiniVent 1000.....	Pg. 32
Selecting A Vent	Pg. 6	AirVent 500	Pg. 37
Installation Systems	Pg. 8	Combo12V/Solar Vent.....	Pg. 38
Typical Installations.....	Pg. 9	Two-Speed 12 Volt Vent.....	Pg. 38
Installation Instructions		Cowl Vent	Pg. 40
Day/Night PLUS.....	Pg. 10	Nicro Warranty.....	Pg. 41
Water Trap Day/Night PLUS	Pg. 17		

Why Ventilate?

WHY VENTILATE?

The unattended boat is constantly generating humidity and moisture below that is the result of water, air and hull surface temperatures that are never identical and always changing. While this is true even in a “dry” climate, the process is accelerated in a humid climate.

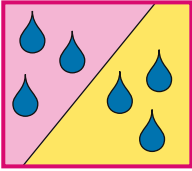

The theory behind ventilation goes beyond just moving air. The point is to equalize the humidity level inside and outside the boat. Contrary to popular belief, closing off the boat cabin to “protect” the boat from humid air entering will further raise the humidity level below deck. No matter where your boat is, humidity and temperature levels vary. When your boat is docked, there is also a differential between air temperature and water temperature that is constantly changing.



When there is a differential in temperature, moisture forms. A good example is a rain storm. Generally, a rain storm occurs when a hot air mass and a cold air mass meet, reducing the humidity in the atmosphere into a denser liquid form. Although not as extreme as a storm, the same phenomenon takes place on your boat on an ongoing basis, due to the temperature differential between the interior cabin (which is affected by water temperature) and the air temperature outside. It is that humidity (or condensation) in the boat’s cabin that will do the most damage.

Over a relatively short period of time - just a few days or a few weeks at most, moisture inside the boat creates an ideal atmosphere for various molds and fungi to grow. This is the root cause of what all boaters need to avoid - **mold, mildew and musty air**. Not only are mold, mildew and musty air unpleasant, but they can damage your boat’s interior fabrics, electronics, and metal components. Over the long term, dry rot and boat blistering (damage to the fiberglass structure) are additional potential costly problems as well.

REMEMBER: Air conditioning works great when you are on your boat, but Nicro ventilation keeps air circulating when you are gone!

Common Ventilation Questions



HOW MUCH VENTILATION IS NEEDED?

We often hear this question. There are two answers - "You cannot have too much," and "Even a little ventilation helps a lot."

Ideally, the air in the interior of a boat should be circulated once every hour. A typical 30-foot boat contains approximately 800 cubic feet of air. Nicro's solar powered models can move between 600 and 1000 cubic feet of air every hour. The general guidelines for providing maintenance ventilation are as follows:



Boat Size	Recommended Ventilation
Up to 24 ft.	1 Exhaust Vent*
24 to 40 ft.	1 Exhaust Vent & 1 Intake Vent
40 ft. and larger	2 Exhaust Vents & 1 Intake Vent

* For effective maintenance ventilation, one vent assumes there will be access for air to get into the cabin (i.e., cowl vent, clam-shell vent or louvered panel).

IF I ALREADY HAVE VENTILATION HATCHES OR AIR CONDITIONING, WHY DO I NEED NICRO VENTILATION?

While it is true that virtually all boats have hatches, in most cases hatches must be secured when the boat is left unattended. Often when underway, hatches must also be closed tight. In both of these scenarios, Nicro ventilation can effectively meet your boat's need for ventilation.

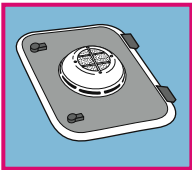

One great suggestion is to mount a Nicro solar vent in the hatch. This installation is easy and does not interfere with the normal function of the hatch.

When air conditioning is turned off, the need for ventilation continues. Nicro solar vents provide hour-after-hour of air exchange to the cabin when the boat is left unattended. Nicro vents also provide a great complement to your air conditioning system by moving cooled air to an area of the boat that is not serviced by an air conditioning duct.

Understanding Ventilation Principles

MAINTENANCE VENTILATION VS. COMFORT VENTILATION

There are two major types of ventilation that Nicro Ventilation Systems provide. The first, maintenance ventilation, is the most critical. **Maintenance ventilation** is defined as the amount of ventilation required to reduce or eliminate the growth of mold, mildew and musty air in the unattended boat cabin. **In general, replacing the air at least once per hour is recommended.**

The best way to guarantee a continuous, 24-hour air flow is by using a Nicro solar powered vent with a rechargeable battery. These vents require no wiring and do not draw off the boat's 12V system.

Comfort ventilation is another significant benefit of Nicro ventilation. It is the amount of ventilation required to affect the comfort level in the cabin. **We recommend that air be circulated at least once per hour per person below deck.**

When intake and exhaust air flows are combined, cross flow ventilation is achieved. All Nicro vents with rechargeable battery back-up come with two fan blades (one for exhaust and one for intake). This makes additional intake air flow easy to accomplish, adding fresh air and comfort below.

To determine your boat's ventilation needs, calculate the interior volume using this formula, then select a vent or vents that will move at least that amount of air in an hour.

See Page 6
"Selecting a Vent"

To Specifically Calculate Your Boat's Air Volume, Use This Simple Formula:

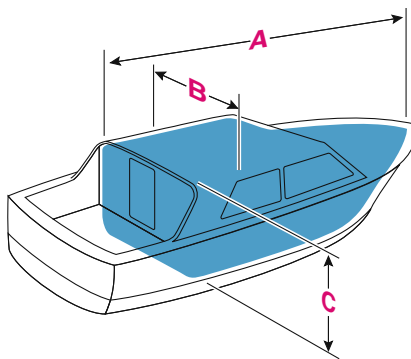

- A** = Interior length (excluding cockpit)
- B** = Boat width
- C** = Average interior height

$$A \times B \times C \times 70\% = \text{Boat Interior Volume}$$

Understanding Ventilation Principles

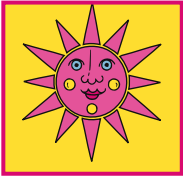

SOLAR TECHNOLOGY

Nicro has been applying solar technology to marine ventilation longer than any other manufacturer. As a result, we have a superior understanding of solar technology. That means your Nicro solar powered vent is designed to function at a high efficiency level, maximizing the ventilation benefit to your boat.

Nicro solar vents utilize solar cells which are technically known as photo voltaic or PV cells. Photovoltaic means “capable of creating voltage when exposed to radiant light, especially visible light energy.” The photovoltaic cells consist of wafer thin crystals which conduct positive and negative charges, resulting in a flow of electricity. The challenge is to minimize the heat generated by this process so as not to interfere with the sunlight-to-electricity conversion. Nicro solar powered vents are engineered to achieve an optimal conversion level that is consistent in every vent we produce.



ACTIVE vs. PASSIVE VENTILATION

Nicro’s ventilation products consist of two types:

“**Active**” vents such as our solar powered and 12V vents which force air either out of or into the boat cabin.

“**Passive**” vents which rely on wind movement to circulate the air in the boat cabin (these vents include the AirVent 500 and our cowl vents).

While both of these forms of ventilation are useful, “active” ventilation is most effective for achieving the consistent air movement necessary for maintenance ventilation.

In addition, “active” solar ventilation, while not as powerful as 12V power, does not require any of your 12V system’s resources. 12V systems are particularly useful in two cases:

1. When greater air movement is required (for bilge area or head for example)
2. When a flat surface for a solar vent is not available, making solar power unfeasible (i.e., when a boat is in a covered slip, sun cannot be absorbed by solar cells effectively).





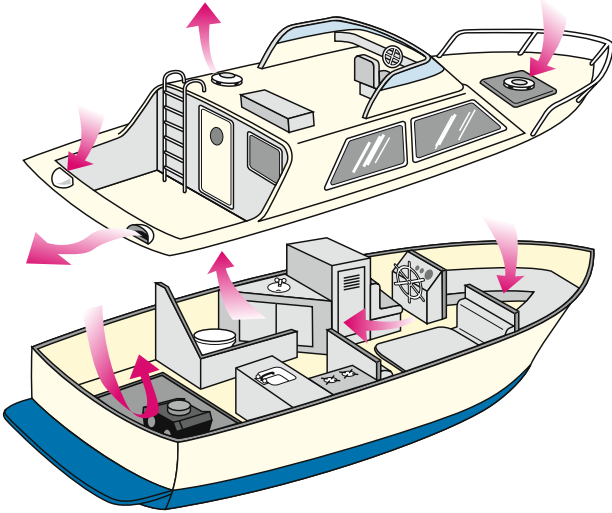



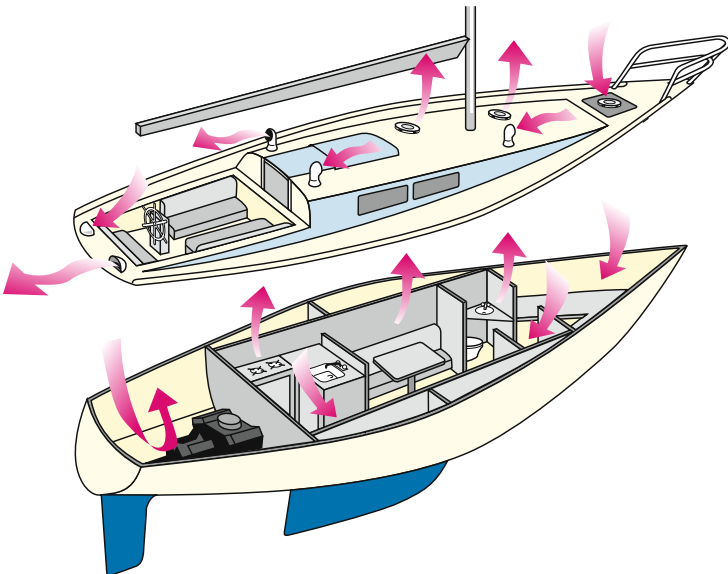







































Understanding Ventilation Principles



It is important to evaluate the cabin layout of your boat to determine optimal locations for both intake and exhaust ventilation. These illustrations suggest placement for Nicro solar powered vents and Nicro passive vents. Note how the placement of the vents creates cross flow ventilation.



Selecting A Vent

Vent Model	Airflow Size	Operation	Intake	Exhaust	Cubic Volume Of Air Per Hour (Cubic Feet / Cubic Meters)
 PowerVent 3000	4" 102mm	 Solar Power  Rechargeable Battery Power			900 ft ³ / 25m ³
 Day&Night 2000	4" 102mm	 Solar Power  Rechargeable Battery Power			800 ft ³ / 23m ³
 Day&Night 2000	3" 76mm	 Solar Power  Rechargeable Battery Power			700 ft ³ / 20m ³
 Day/Night PLUS	4" 102mm	 Solar Power  Rechargeable Battery Power			1000 ft ³ / 28m ³
 Day/Night PLUS	3" 76mm	 Solar Power  Rechargeable Battery Power			600 ft ³ / 17m ³
 MiniVent 1000	3" 76mm	 Solar Power  Passive			700 ft ³ / 20m ³
 Combo 12 Volt/ Solar	4" 102mm	 12V 12V Power 24 hrs/day  Solar Power 8 hrs/day			1,100 ft ³ / 31m ³ 800 ft ³ / 23m ³
 Two Speed 12 Volt	4" 102mm	 12V High Setting  12V Low Setting			2,000 ft ³ / 57m ³ 1,500 ft ³ / 42m ³
 AirVent 500	3" 76mm	 Passive		 Passive In a 15 Knot Breeze	600 ft ³ / 17m ³
 3" PVC Cowl Vent	3" 76mm	 Passive			
 4" PVC Cowl Vent	4" 102mm	 Passive			

Selecting A Vent

Cubic Volume Of Air Per Day (Cubic Feet / Cubic Meters)	Deck Plate	Hole Size	Deck Plate Outer Diameter	Mounting Flange Depth
21,600 ft ³ / 600m ³	NONE Direct to Deck Mounting	4-3/4" 121mm		1-1/2" 38mm
19,200 ft ³ / 552m ³	4" Snap-In	4-3/4" 121mm	6" 153mm	1" 25mm
16,800 ft ³ / 480m ³	3" Snap-In	3-3/4" 95mm	5" 127mm	1" 25mm
24,000 ft ³ / 672m ³	NONE Direct to Deck Mounting	4-3/4" 121mm		1.75" 45mm
14,400 ft ³ / 408m ³	NONE Direct to Deck Mounting	3-3/4" 95mm		1.75" 45mm
5,600 ft ³ / 160m ³	NONE Direct to Deck Mounting	3-3/4" 95mm		1" 25mm
26,400 ft ³ / 744m ³ 6,400 ft ³ / 184m ³	4" Snap-In	4-3/4" 121mm	6" 153mm	1" 25mm
48,000 ft ³ / 1,368m ³ 36,000 ft ³ / 1,008m ³	4" Snap-In	4-3/4" 121mm	6" 153mm	1" 25mm
	NONE Direct to Deck Mounting	3-3/4" 95mm		1" 25mm
	3" Snap-In	3-3/4" 95mm	5" 127mm	1" 25mm
	4" Snap-In	4-3/4" 121mm	6" 153mm	1" 25mm

NICRO VENTILATION INSTALLATION SYSTEMS

Snap-In Deck Plate Installation

The Day&Night 2000, 12 volt vent, 12 volt combo vent and cowl vents use the Nicro Snap-In deck plate system. The Snap-In system allows the easy exchange of any Snap-In part for upgrading or convenience, as well as the use of a Snap-In cover that completely seals the deck plate making it water tight.

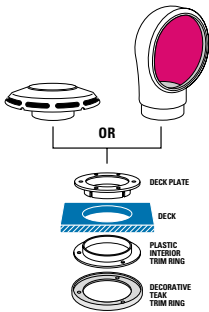

Direct-To-Deck Installation

The Day/Night PLUS, PowerVent 3000, MiniVent 1000 and AirVent 500 are designed to be installed directly to the deck without the requirement for a deck plate. All of these vent systems have built-in shut-off dampers that operate from below.

Installation

All Nicro Ventilation products include clear, easy-to-understand installation instructions. These instructions address all of the key factors to a professional installation, such as:

- **Proper hole measurement and cutting procedures**
- **Proper deck plate installation**
- **Use of sealants to waterproof your vent installation**
- **Installing vents in hatches**
- **Installing vents in "cambered" or slightly curved decks**
- **Use of interior trim rings to "dress up" the cabin**

The high quality level of Nicro Ventilation products must be combined with a sound installation to guarantee that your vent performs in all conditions. Nicro will make sure that your installation will be easy and successful so that you can enjoy the benefits of installation for a long time to come.

NOTE: Models with threaded deck plates (as opposed to snap-in deck plates) have different installation hole size requirements. Please consult installation instructions included with the product for these models.

Complete Instructions for Solar Vents and Deck Plate installations can be found starting on page 10.

Typical Installations



Here are some examples of Micro vents installed in hatches and on boats. As you can see, the hatch installation is very attractive, and because the vents are solar and battery powered they require no wiring and do not effect the operation of the hatch.

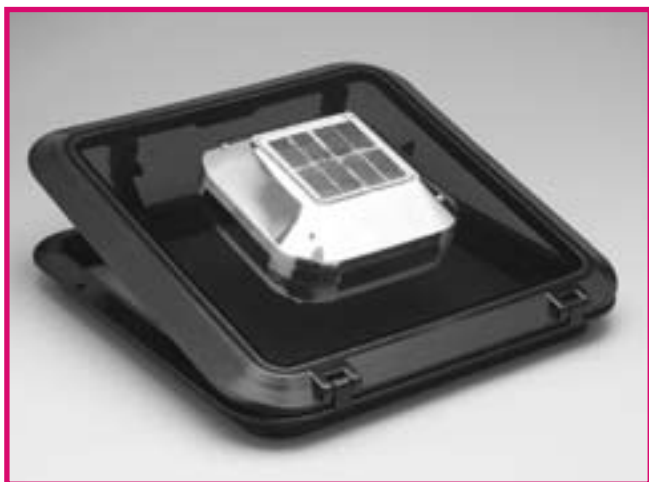

Installing The Day/Night PLUS



Day/Night PLUS Components:

- Cover with Solar Array, Motor Housing & On-Off Switch
- Base Plate with Shut-Off Damper
- Rechargeable Battery (installed under solar array)
- 1 Intake Fan & 1 Exhaust Fan (installed)
- Optional Insect Screen
- Interior Trim Ring
- 1 Gasket and Mounting Hardware Kit

To ensure that you successfully complete your installation, carefully follow these instructions. Make sure to review the following **Precautions and Problem Areas to Avoid** before you begin.

PRECAUTIONS

The Day/Night PLUS is designed to fit directly to the deck or hatch surface of your boat. The vent unit mounts onto a base plate that must be installed correctly to insure proper operation. There are three (3) important factors that must be addressed to insure a good base plate installation:

1. Make sure the base plate is properly caulked when fastening it to the deck or hatch. We recommend using a 1/4" to 1/2" (7mm-12mm) wide bead of silicone sealant. The sealing gasket (included) may also be used if the vent is being mounted on a flat surface without curvature.
2. The installation hole must be cut to 4-3/4" (121mm) in diameter for a 4" vent or 3-3/4" (95mm) in diameter for a 3" vent, so that the surface around the base plate is not distorted and the interior trim ring will fit properly. Measure carefully to cut the properly sized hole.

NOTE: For your convenience, this vent has been designed to fit the same size hole cut-outs as older model 3" and 4" snap-in Nicro Day&Night 2000 vents. Simply remove the 3" or 4" snap-in deck plate from your older vent unit and replace it with the 3" or 4" base plate from the new unit.

3. When installing the vent on a cambered surface, make sure you do not tighten the fasteners too much; this will distort the base plate and may cause the vent to leak.

Installing The Day/Night PLUS

VERY CRITICAL: DECK CAMBER (or deck curvature)

When installing the Day/Night PLUS Vent on a cambered, or curved, surface, it is critical to check to make sure there is no more than 1/2" (12mm) of camber over a 12" (300mm) length of deck surface. Too much camber will distort the unit's base plate, causing the cover to be raised off the deck. This creates the potential for water to get under the cover and may also prevent the damper from closing properly.

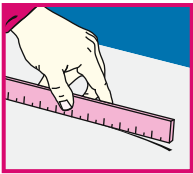

To check for camber, place a 12" (300mm) straight edge on the deck location for the vent and try to rock it. Then rotate it 90 degrees and repeat.

PROBLEM AREAS TO AVOID

Cut the hole for your Day/Night PLUS only after carefully considering the location and the correct sizing of the hole. We recommend that you **MEASURE TWICE AND CUT ONCE !**

DO NOT install the Day/Night PLUS in an area with more than 1/2" of camber over a 12" length of deck surface.

Be careful that the location you select for the through-deck hole does not go through any electrical wiring, plumbing or other obstructions. Be sure that power tools are properly grounded. Take the time to bed the base plate and fasteners properly with sealant. Silicone seal or Boat LIFE Life Seal® are good for flat installations on wood or fiberglass. Polyurethane bedding compound such as 3M 5200® or Sikaflex® are recommended on cambered surfaces or hatch installations where fasteners will not be used.

CAUTION: Do not use polysulfide compounds, as they will melt the plastic.

Installing The Day/Night PLUS

INSTALLING THE DAY/NIGHT PLUS VENT IN A HATCH OR THROUGH THE DECK



STEP ONE: MARKING THE HOLE

When mounting on a deck, make sure to check the camber of the deck. See Precautions.

The Day/Night PLUS comes fully assembled. The first step is to remove the cover from the base plate. To do so, simply remove the 3 stainless steel screws at the edges of the solar array and lift the cover off from the base plate. Be careful not to lose the sealing O-rings around each of the screws. When lifting off the cover, please note that the same 3 screws also hold the solar array onto the cover - **so, be careful that the solar array does not fall off from the cover and damage or disconnect the internal wiring.**

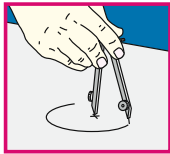

Carefully choose the installation location that will receive good sunlight. If a hole saw is to be used simply mark the center of the installation spot with an "X" for the pilot bit to penetrate. If a saber saw is to be used, scribe the circumference of the hole with a compass.

NOTE: The 4" vent requires a 4-3/4" (121mm) diameter hole, and the 3" vent requires a 3-3/4" (95mm) diameter hole.

TIP: If you are installing the Day/Night PLUS using the saber saw method and are concerned about scratching the deck or hatch with the base plate of the saw follow this tip: Select your installation location and, before scribing the circumference, cover the entire area with wide masking tape. Scribe the circumference on top of the tape. The tape will protect the installation surface while you are cutting the hole.

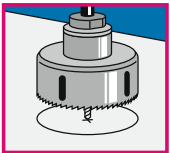

STEP TWO: CUTTING THE HOLE

Using a Hole Saw

If you are cutting the hole with a hole saw, we recommend the use of a variable speed drill. Cutting the hole at a lower RPM will ensure that the hole is not cut too quickly, which can melt the plastic on a hatch. Follow the directions for the drill motor itself and be sure it is properly grounded. A slow, steady speed is preferred. Be sure to stop and clean out the hole and the hole saw periodically.

Using a Saber Saw

To cut the hole with a saber saw, select a blade that is compatible with the material you are cutting (fiberglass, wood, acrylic etc.). Be sure the saw is properly grounded. Drill a pilot hole near the inside edge of the scribed circumference that is big enough to

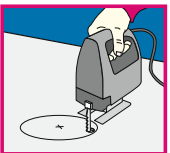

Installing The Day/Night PLUS

insert the saw blade into. Insert the saw blade into the hole and slowly start cutting out to the scribed circumference. Cut carefully to avoid mistakes, breaking the blade, or melting the plastic on a hatch. Always cut right on your line or just outside of it.

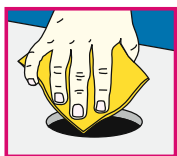

Finishing the Hole

Sand the edge of the hole smooth so that the trim ring and base plate fit properly. Test fit the entire unit. If the deck is cored with wood or foam, seal the exposed edge of the material with epoxy to prevent moisture from penetrating into the core.

NOTES: Most hatches are made of acrylic which is very durable. Even older acrylic is easy to cut and will not chip or crack as long as the proper tools and methods are used.

STEP THREE: INSTALLING INTERIOR TRIM RING

Deck Mount

For decks having a thickness of 1" (25mm) or more, place the trim ring into the hole from the interior side and mark the 3 fastener holes. Make sure the holes do not lie directly beneath the holes to be drilled for the base plate installation in step 4. Remove trim ring and drill out the holes with a 5/32" bit. Place trim ring back into hole to insure correct alignment. Fasten the trim ring into place with three #10 x 3/4" flat head screws provided. For decks having a thickness of less than 1", the NICRO spacer ring is required (#N10863SP for 3" vent, or # N10864SP for 4" vent) or the trim ring can be left off. If desired, the NICRO soft vinyl protective ring (#N10863PR for a 3" vent or #N1864PR for a 4" vent) can be press fit on or installed with contact cement to cover the protruding portion of the base plate.

Hatch Mount

The interior trim ring can be left off for a hatch mount, or the NICRO soft vinyl protective ring (#N10863PR for a 3" vent or #N1864PR for a 4" vent) can be press fit on the protruding portion of the base plate. To install the interior trim ring on a hatch which is less than 1" (25mm) thick, the NICRO spacer ring (#N10863SP for 3" vent, or # N10864SP for 4" vent) is required.

CAUTION: Do Not Use the #10 sheet metal screws to install the trim ring in an acrylic hatch as this may cause a hatch to crack.

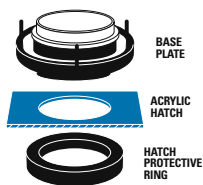
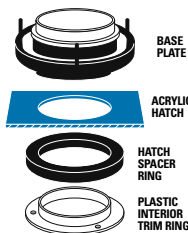
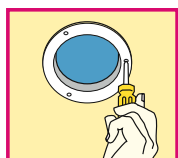

Installing The Day/Night PLUS

STEP FOUR: INSTALLING THE BASE PLATE

It is important to rough up the bonding surfaces between the base plate and hatch or deck to get a good water tight seal. Use 100 grit sandpaper around the edge of the installation hole and around the bottom of the base plate.



Deck Installation

Place the base plate into the hole from the outside and mark the three (3) fastener holes. Make sure the three fastener holes do not interfere with the trim ring screw holes from step 3. Remove base plate and drill 5/32" holes. Do not penetrate all the way through the deck. Place base plate back into hole to insure correct alignment.



Apply a 1/4" (7mm) bead of silicone sealant around the outside edge of the installation hole and around the fan housing (flange) where it meets the base. Place the gasket over the flange on the bottom of the base plate, while aligning the screw holes then press gently into the sealant. Turn the unit over and place into the hole making sure the screw holes are lined up. The gasket alone should not be used on a cambered deck as it may not seal properly.

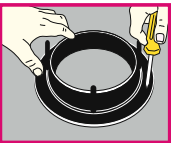

Fasten the base plate into place with the three #10 x 1" long pan head fastener screws provided. **CAUTION: Use shorter screws if your deck is less than 1" (25mm) thick. DO NOT over-tighten the three mounting screws. Install the trim ring gasket first (Step 3), then the base plate, using only a hand-held screwdriver.**

Hatch Installation

The gasket is optional for hatch installations. Fastener holes are not required for hatch installations if the base plate is to be glued to the hatch. If machine screws (not provided) are to be used, drill 7/32" clearance holes completely through the material using the base plate as a template to mark the center location of the holes. To glue the base plate to a hatch, apply a 1/4" (7mm) bead of polyurethane bedding compound around the outside edge of the installation hole. Be sure to seal the three (3) mounting holes on the base plate. Place the base plate into the hole and press gently until seated. Allow polyurethane to dry completely.

If you choose to use fasteners (not provided) to install the base plate, #10 machine screws with a nylock nut and washer or barrel nut can be used for a full cosmetic finish. **CAUTION: Do not use the #10 sheet metal screws provided with this unit on a hatch**

Installing The Day/Night PLUS

installation as they may crack the hatch. It is important to use an adequate amount of silicone sealant on the base and on the fasteners to keep water from “weeping” down the threads. **DO NOT** over-tighten the mounting screws. Install the trim ring (and optional spacer) first, then the base plate, using only a **HAND-HELD** screwdriver.

STEP FIVE: INSTALLING COVER TO BASE PLATE

There are 3 plastic mounting bosses for the cover spaced evenly around the base plate. Place the cover over the base plate and thread the 3 cover screws with sealing O-rings carefully into the plastic bosses on the base plate. Make sure the cover is properly aligned with the base plate so that the fan blade spins freely. **It is important to get all three cover screws started before you tighten them down completely. DO NOT over-tighten the screws, or you may strip the plastic bosses.**

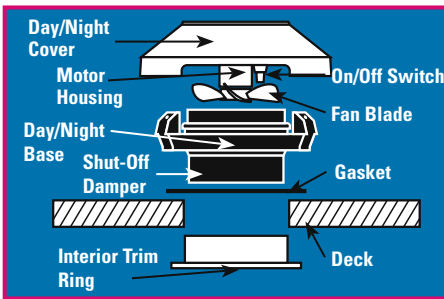

FEATURES & OPERATION

On-Off Switch

The Day/Night PLUS comes with an on-off switch which is located inside the fan housing. To operate, gently place your finger on the hub of the fan until it stops rotating, then just press the rubber covered switch on or off. Setting the switch to the off position cuts all current from the solar array and battery to the fan

motor. All the current produced by the solar array is therefore used to charge the battery.

Shut-Off Damper

The Day/Night PLUS is equipped with a green water shut-off damper which can be operated from below. There are two ears on the inside edge of the fan housing.

To open and allow outside air flow, pull the damper down about a 1/2" (13mm). To close, push it up until it rests and seals against the vent cover. The damper slide may need lubrication occasionally if it is hard to open and close. To lubricate, remove the cover and apply a small amount of silicone grease around the top of the damper tube.

To prevent unnecessary wear on the motor, switch the vent to the off position when the shut-off damper is in the closed position.

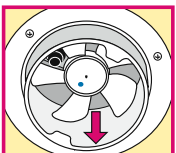
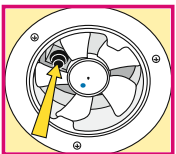

Installing The Day/Night PLUS



Intake & Exhaust Fan Blades

The Day/Night PLUS comes with two fan blades, one intake and one exhaust. Each blade is labeled on the hub with either a red dot for intake or a blue dot for exhaust. To exchange fan blades, simply stop fan blade by gently pressing on the hub to slow the blade down. Reach inside and switch the motor off. Pull the existing fan blade off and push the new one on, making sure you have the colored dot showing. **CAUTION: A straight pull or push of the fan blade should be exerted to ensure that you do not bend the motor shaft. When replacing the fan blade be sure that the fan blade is not pressed against the motor housing, as this will cause the fan to bind reducing performance.** If you have only one vent installed on your boat, we recommend using the exhaust fan blade; if you have multiple vents, try different configurations of intake and exhaust to achieve effective cross flow ventilation.

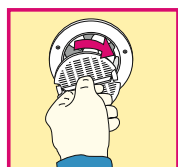

Insect Screen

Your new vent comes with a removable insect screen that attaches to the shut-off damper. Installation of the insect screen is optional. The screen is easy to install by grasping the fin in the center and carefully twisting it in a clockwise motion. Make sure to clean the insect screen periodically to ensure maximum air flow.

Rechargeable Battery

Each Day/Night PLUS vent is equipped with a built-in replaceable battery. The solar array keeps the battery charged during daylight hours so that it can run the fan at night and during low light situations. The Day/Night PLUS will run for up to 40 hours without sunlight on a fully charged battery. Average battery life is 3-5 years, depending on climate conditions.

NOTE: To maximize battery life, make sure it is as fully charged as possible during initial use. To fully charge, expose vent to the sun, (not a light bulb) for 24 to 36 hours. This will insure a fully-charged battery. *(Depending on angle to the sun, weather conditions, and shadowing of the solar array, the time necessary to charge the battery may vary.)*

MAINTENANCE

Your Day/Night PLUS vent is a maintenance-free ventilator. However, it is very important to keep the nine drain holes around

Installing The Day/Night PLUS

the edge of the base plate clear at all times. Failure to do so will allow water to accumulate in the base and possibly enter the cabin. It is also recommended to periodically clean the solar array with a mild cleaner to ensure the vent charges continuously and receives maximum sunlight. If after a few years of operation the battery is no longer performing at peak performance, replace it with a rechargeable C-cell battery rated at 2800 mAh or greater.

TROUBLE SHOOTING – If the Day/Night PLUS vent stops running:

- **Check the On-Off Switch** – Make sure the switch is on.
- **Check the Solar Array** – Make sure the solar array is not covered up by shade
- **Check Fan Blade** – Make sure the fan blade has not been pushed up the motor shaft too far so that it is pressed against the motor housing. This will cause the fan to bind, reducing performance, and may also cause the vent to become "noisy". To remedy, simply pull the fan blade away from the motor housing (aprox. 1/16") until fan functions normally.
- **Check/Replace the Battery** –If the switch is on and the vent is not working, the battery may be dead. A dead battery short circuits the solar array and will not deliver power to the motor. You can replace the battery by removing the solar array in the center of the cover. Remove the three screws around the edges of the array cover. Be careful not to lose the small O-rings on the screws. Lift off the array cover, being very careful not to over extend or break the wires that attach the array to the vent. Lift off the array cover slowly and carefully. If needed, a small, flat-blade screwdriver may be used to pry up the solar array cover (there are two pry slots located at opposite ends on the edge of the array cover). Remove the rechargeable battery. Test the vent without the battery in it by placing the array in direct sun to see if the motor turns (make sure the switch is on). If the motor turns, the battery is dead. Replace the battery with a C size rechargeable battery with a minimum rating of 2800 mAh. Make sure to observe correct battery polarity (positive and negative). Reverse charging of the battery is not acceptable. **DO NOT** use non-rechargeable batteries to run the vent. Be sure to clean the battery contacts before installing a new battery. Use the flat surface of a pencil eraser, or if heavier build-up has occurred, use either a fine emery cloth or fine grit sandpaper (especially on the positive battery contact). If needed, apply some silicone grease around the perimeter of the solar array and reattach the array to the cover with the three screws and sealing O-rings (do not over-tighten). Dispose of the old battery properly.

NOTE: The vent can work without the battery, but only during sunlight hours.

• **Check The Solar Array & Fan Motor**

If the motor still did not turn when the battery was removed, either the array is damaged or the motor does not work. Contact Nicro customer service for warranty repair or replacement.

Installing The PowerVent 3000



PowerVent 3000 Components:

- Cover with Solar Array, Motor Housing & On-Off Switch
- Base Plate with Shut-Off Damper
- Ni-Cad Battery (installed under solar array)
- 1 Intake Fan & 1 Exhaust Fan (installed)
- 4 Insect Screens
- Interior Trim Ring
- 1 Gasket and Mounting Hardware Kit

To ensure that you successfully complete your PowerVent 3000 installation, carefully follow these instructions. Make sure to review the following **Precautions and Problem Areas to Avoid** before you begin.

PRECAUTIONS

The PowerVent 3000 is designed to fit directly (i.e., flush-mounted) to the deck or hatch surface of your boat. The vent unit mounts onto a base plate that must be installed correctly to insure proper operation. There are three (3) important factors that must be addressed to insure a good base plate installation:

1. Make sure the base plate is properly caulked when fastening it to the deck or hatch. We recommend using a 1/4" to 1/2" (7mm-12mm) wide bead of silicone sealant.
2. The installation hole must be cut to 4-3/4" (121mm) in diameter, so that the surface around the base plate is not distorted. Measure carefully to cut the 4-3/4" (121mm) hole.
3. When installing the vent on a cambered surface, make sure you do not tighten the fasteners too much; this will distort the base plate and may cause the vent to leak.

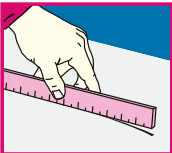

VERY CRITICAL: DECK CAMBER (or deck curvature)

When installing the PowerVent 3000 on a cambered, or curved, surface, it is critical to check to make sure there is no more than 1/2" (12mm) of camber over a 12" (300mm) length of deck surface. Too much camber will distort the unit's base plate, causing the cover to be raised off the deck. This creates the potential for water to get under the cover and may also prevent the damper from closing properly.

To check for camber, place a 12" (300mm) straight edge on the deck location for the vent and try to rock it. Then rotate it 90 degrees and repeat.

Installing The PowerVent 3000

PROBLEM AREAS TO AVOID

Cut the hole for your PowerVent 3000 only after carefully considering the location and the correct sizing of the hole. We recommend that you **MEASURE TWICE AND CUT ONCE !**

DO NOT install the PowerVent 3000 in an area with more than 1/2" of camber over a 12" length of deck surface.

Be careful that the location you select for the through-deck hole does not go through any electrical wiring, plumbing or other obstructions. Be sure that power tools are properly grounded. Take the time to bed the base plate and fasteners properly with sealant. Silicone seal or Boat LIFE Life Seal® are good for flat installations on wood or fiberglass. Polyurethane bedding compound such as 3M 5200® or Sikaflex® are recommended on cambered surfaces or hatch installations where fasteners will not be used. **CAUTION: Do not use polysulfide compounds, as they will melt the plastic.**

INSTALLING The PowerVent 3000 IN A HATCH OR THROUGH THE DECK

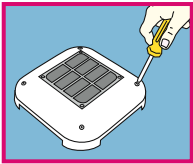

STEP ONE: MARKING THE HOLE

When mounting on a deck, make sure to check the camber of the deck. See Precautions.

The PowerVent 3000 comes fully assembled. The first step is to remove the cover. To do so, simply remove the 4 stainless steel screws in each corner of the cover to separate it from the base. Carefully choose the installation location. If a hole saw is to be used simply mark the center of the installation spot with an "X" for the pilot bit to penetrate. If a saber saw is to be used, scribe the circumference of the hole with a compass or trace the outline of the outside edge of the trim ring.

NOTE: The PowerVent 3000 requires a 4-3/4" (121mm) dia. hole.

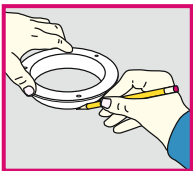
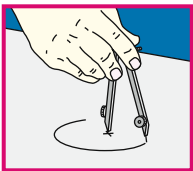

TIP: If your are installing the PowerVent 3000 using the saber saw method and are concerned about scratching the deck or hatch with the base plate of the saw follow this tip: Select your installation location and, before scribing the circumference, cover the entire area with wide masking tape. Scribe the circumference on top of the tape. The tape will protect the installation surface while you are cutting the hole.

Installing The PowerVent 3000

STEP TWO: CUTTING THE HOLE

Using a Hole Saw

If you are cutting the hole with a hole saw, we recommend the use of a variable speed drill. Cutting the hole at a lower RPM will ensure that the hole is not cut too quickly, which can melt the plastic on a hatch. Follow the directions for the drill motor itself and be sure it is properly grounded. A slow, steady speed is preferred. Be sure to stop and clean out the hole and the hole saw periodically.

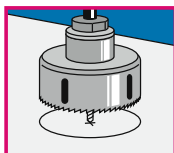

Using a Saber Saw

To cut the hole with a saber saw, select a blade that is compatible with the material you are cutting (fiberglass, wood, acrylic etc.). Be sure the saw is properly grounded. Drill a pilot hole near the inside edge of the scribed circumference that is big enough to insert the saw blade into. Insert the saw blade into the hole and slowly start cutting out to the scribed circumference. Cut carefully to avoid mistakes, breaking the blade, or melting the plastic on a hatch. Always cut right on your line or just outside of it.

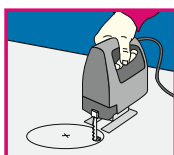

Finishing the Hole

Sand the edge of the hole smooth so that the trim ring and base plate fit properly. Test fit the entire unit. If the deck is cored with wood or foam, seal the exposed edge of the material with epoxy to prevent moisture from penetrating into the core.

NOTE: Most hatches are made of acrylic which is very durable. Even older acrylic is easy to cut and will not chip or crack as long as the proper tools and methods are used.



STEP THREE: INSTALLING INTERIOR TRIM RING

Deck Mount

The trim ring does not have to be installed. When installing the interior trim ring in a deck which is less than 1" (25mm) thick, the Nicro spacer ring (#N10864SP) is required or the Nicro soft vinyl protective ring (#N10864PR) can be installed with contact cement to cover the protruding portion of the base plate. To install the trim ring, place the trim ring into the hole from the interior side and mark the fastener holes. Make sure the holes do not lie directly beneath the holes to be drilled for the base plate installation in Step 4. Remove trim ring and drill out the holes

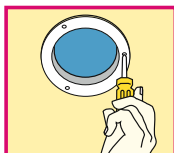

Installing The PowerVent 3000



BASE PLATE



ACRYLIC HATCH



HATCH SPACER RING



PLASTIC INTERIOR TRIM RING



BASE PLATE



ACRYLIC HATCH



HATCH PROTECTIVE RING

with a 5/32" bit. Place trim ring back into hole to ensure correct alignment. Fasten the trim ring into place with the three #10x3/4" flat head screws provided.

Hatch Mount

The interior trim ring can be left off for a hatch mount, or the Nicro soft vinyl protective ring (#N10864PR) can be installed to cover the protruding portion of the base plate. To install the interior trim ring on a hatch which is less than 1" (25mm) thick, the Nicro spacer ring (#N10864SP) is required.

CAUTION: Do not use the #10 sheet metal screws to install the trim ring in an acrylic hatch as this may cause the hatch to crack.

STEP FOUR: INSTALLING THE BASE PLATE

It is important to rough up the bonding surfaces between the base plate and hatch or deck to get a good water tight seal. Use 100 grit sandpaper around the edge of the installation hole and around the bottom of the base plate.

Deck Installation

Place the base plate into the hole from the outside and mark the three (3) fastener holes. For an attractive installation, make sure at least one edge of the base plate is parallel to the edge of the deck. Mark the three fastener holes making sure they do not interfere with the trim ring screw holes from Step 3. Remove base plate and drill 5/32" holes. Do not penetrate all the way through the deck. Place base plate back into hole to insure correct alignment. Apply a 1/4" (7mm) bead of silicone sealant around the outside edge of the installation hole and around the fan housing (flange) where it meets the base. Place the gasket over the flange on the bottom of the base plate, while aligning the screw holes then press gently into the sealant. Turn the unit over and place into the hole making sure the screw holes are lined-up. The gasket should not be used on a cambered deck. Fasten the base plate into place with the #10 pan head fastener screws provided. **CAUTION: Use shorter screws if your deck is less than 3/4" (19mm) thick. DO NOT over-tighten the three mounting screws. Install the trim ring first (Step 3), then the base plate, using only a HAND-HELD screwdriver.**

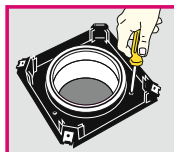
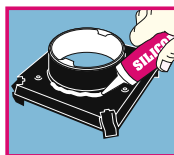

Installing The PowerVent 3000

Hatch Installation

The gasket is optional for hatch installations.

Fastener holes are not required for hatch installations if the base plate is to be glued to the hatch. If machine screws (not provided) are to be used, drill 7/32" clearance holes completely through the material using the base plate as a template to mark the center location of the holes.

To glue the base plate to a hatch, apply a 1/4" (7mm) bead of polyurethane bedding compound around the outside edge of the installation hole. Be sure to seal the three (3) mounting holes on the base plate. Place the base plate into the hole and press gently until seated. Allow polyurethane to dry completely. If you choose to use fasteners (not provided) to install the base plate, #10 machine screws with a nylock nut and washer or barrel nut can be used for a full cosmetic finish. **CAUTION: Do not use the #10 sheet metal screws provided with this unit on a hatch installation as they may crack the hatch.** It is important to use an adequate amount of silicone sealant on the base and on the fasteners to keep water from "weeping" down the threads. **DO NOT** over-tighten the mounting screws. Install the trim ring (and optional spacer) first, then the base plate, using only a HAND-HELD screwdriver.

For an attractive installation, make sure at least one edge of the base plate is parallel to the edge of the hatch.

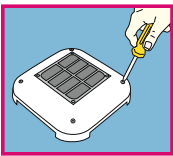

STEP FIVE: INSTALLING COVER TO BASE PLATE

Included with the PowerVent 3000 are four insect screens which fit into the slots between corners of the base plate unit. Install the screens now if you wish to use them. There are four Tinnerman nuts, one in each corner of the base plate. Place the

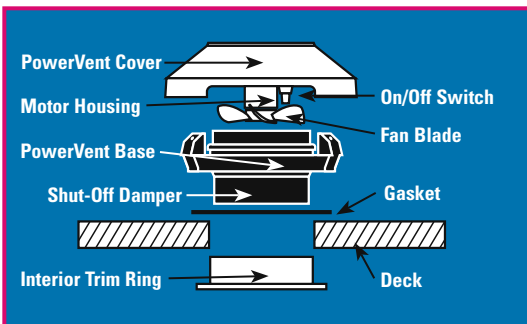

It is important to get all four cover screws started before you tighten them down.

DO NOT over-tighten the screws, or you may strip the Tinnerman nuts.

Installing The PowerVent 3000

cover over the base plate and thread the machine screws carefully into the cover. Make sure the cover is properly aligned with the base plate so that the fan blade spins freely.

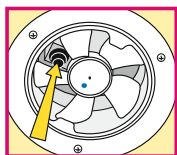

FEATURES & OPERATION

On-Off Switch

The PowerVent 3000 comes with an on-off switch which is located inside the fan housing. To operate, gently place your finger on the hub of the fan until it stops rotating, then just press the rubber covered switch on or off.

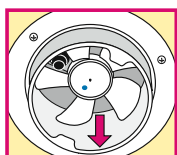

Shut-Off Damper

The PowerVent 3000 is equipped with a green water shut-off damper which can be operated from below. There are two ears on the inside edge of the fan housing.

To open, pull the damper down about a 1/2" (13mm). To close, push it up until it is flush with the base of the fan housing. The damper slide may need lubrication occasionally if it is hard to open and close. To lubricate, remove the cover and apply a small amount of silicone grease around the top of the damper tube.



Intake & Exhaust Fan Blades

The PowerVent 3000 comes with two fan blades, one intake and one exhaust. Each fan blade is labeled on the hub with either a red dot for intake or a blue dot for exhaust. To exchange fan blades, simply stop fan blade by gently pressing on the hub to slow the fan blade down. Reach inside and switch the motor off. Pull the existing fan blade off and push the new one on, making sure you have the colored dot showing. **CAUTION: A straight pull or push of the fan blade should be exerted to ensure that you do not bend the motor shaft. When replacing the fan blade be sure that the fan blade is not pressed against the motor housing, as this will cause the fan to bind reducing performance.** If you have only one vent installed on your boat, we recommend using the exhaust fan blade; if you have multiple vents, try different configurations of intake and exhaust to achieve effective cross flow ventilation.

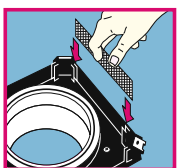

Insect Screens

Installation of the insect screen is optional. The four insect screens are easy to install by placing them in the slots between the corners of the base plate when the cover has been removed. If you use the screens make sure you clean them periodically to ensure maximum air flow.

Installing The PowerVent 3000

Ni-Cad Battery

Each PowerVent 3000 is equipped with a built-in replaceable Ni-Cad battery. The solar array keeps the battery charged during daylight hours so that it can run the fan at night and during low light situations. The PowerVent 3000 will run for up to 48 hours without sunlight on a fully charged battery. Average battery life is 3-5 years depending on climate conditions.

MAINTENANCE

Your PowerVent 3000 is a maintenance-free ventilator. However, it is very important to keep the four drain holes in the corners of the base plate clear at all times. Failure to do so will allow water to accumulate in the base and possibly enter the cabin. It is also recommended to periodically clean the solar array with a mild cleaner to ensure the vent charges continuously.

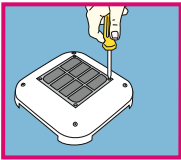

TROUBLE SHOOTING – If the PowerVent 3000 stops running:

- **Check the On-Off switch** – Make sure the switch is on.
- **Check the Battery** – If the switch is on and the vent is not working, the battery may be dead. A dead battery short circuits the solar array and will not deliver power to the motor. You can replace the battery by removing the solar array in the center of the cover. Remove the four screws in the corners of the array cover. Be careful not to lose the small O-rings on the screws. Lift off the array cover, being careful not to damage the O-ring gasket or break the wires that attach the array to the vent. Remove the Ni-Cad battery. Test the PowerVent 3000 without the battery in it by placing the array in direct sun to see if the motor turns (make sure the switch is on). If the motor turns, the battery is dead. Replace the battery with a C size Ni-Cad battery with a minimum rating of 2.0 amp-hours (#N20590). Be sure to clean the battery contacts before installing a new battery. Apply a light coat of silicone grease to the solar array O-ring, and place it back around the perimeter of the solar array. Reattach the array with the four corner screws (do not over-tighten). Dispose of the old battery properly.
- **Check the Solar Array & Fan Motor** – If the motor still did not turn when the battery was removed, either the array is damaged or the motor does not work. Contact Nicro customer service for warranty repair or replacement.

IF YOU HAVE ANY QUESTIONS FAX OR CALL OUR CUSTOMER SERVICE DEPARTMENT (SEE BACK COVER)

Installing The Day&Night 2000



Day&Night 2000 Components:

- Day&Night Solar Vent
- Ni-Cad Battery
- Deck Plate & Deck Plate Cover
- 1 Intake & 1 Exhaust Fan (installed)
- Interior Trim Ring
- 9 #10x3/4" Flat Head Screws

To ensure that you successfully complete your Day&Night 2000 installation, carefully follow these instructions. Make sure to review the following Precautions and Problem Areas to Avoid before you begin.

PRECAUTIONS

The Day&Night 2000 is designed to be installed on the deck or hatch surface of your boat by means of a deck plate. There are three (3) important factors that must be addressed to insure a good deck plate installation:

1. Make sure the deck plate is properly caulked when fastening it to the deck or hatch. We recommend using a 1/4" to 1/2" (7mm-12mm) wide bead of silicone sealant.
2. The installation hole must be cut to 4-3/4" (121mm) in diameter for a 4" vent, 4-3/8" (111mm) for the threaded brass deck plate or 3-3/4" (95mm) in diameter for a 3" vent. This will insure that the opening of the deck plate is not distorted. Measure carefully to cut the proper sized hole.
3. When installing the deck plate on a cambered surface, make sure you do not tighten the fasteners too much; this will distort the deck plate and may result in leakage.

VERY CRITICAL: DECK CAMBER (or deck curvature)

When installing the deck plate where deck camber exists, it is critical that a polyurethane caulking compound be used such as Sikaflex® or 3M 5200® to insure a good water tight seal.

To check for camber, place a 12" (300mm) straight edge on the deck location for the vent and try to rock it. Then rotate it 90° and repeat.

Do not install the vent in an area with more than 1/2" (12mm) of camber over 12" (300mm) length of deck surface. Too much camber will distort the unit's deck plate and may result in leakage. To fasten the deck plate on a cambered surface, line up two of the six screw holes perpendicular to the camber and drill all

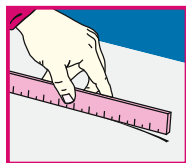

Installing The Day&Night 2000

six pilot holes. After bedding the deck plate with a polyurethane caulking compound, tighten up the two screws and leave the other four snug but not tight. Place the straight edge across the deck plate and be sure that it lies flat on both outside flanges. Let the polyurethane bedding compound dry thoroughly before installing the vent.

PROBLEM AREAS TO AVOID

Cut the hole for your Day&Night 2000 only after carefully considering the location and the correct sizing of the hole.

We recommend that you **MEASURE TWICE AND CUT ONCE!**

DO NOT install the Day&Night 2000 in an area with more than 1/2" of camber over a 12" length of deck surface.

Be careful that the location you select for the through-deck hole does not go through any electrical wiring, plumbing or other obstructions. Be sure that power tools are properly grounded.

Take the time to bed the deck plate and fasteners properly with sealant. Silicone seal or Boat LIFE Life Seal® are good for flat installations on wood or fiberglass. Polyurethane bedding compound such as 3M 5200® or Sikaflex® are recommended on cambered surfaces or hatch installations where fasteners will not be used. **CAUTION: Do not use polysulfide compounds, as they will melt the plastic.**

INSTALLING The Day&Night 2000 IN A HATCH OR THROUGH THE DECK

STEP ONE: MARKING THE HOLE

When mounting on a deck, make sure to check the camber of the deck. See Precautions.

Carefully choose the location on the hatch or deck where the Day&Night 2000 will be installed. If a hole saw is to be used simply mark the center of the installation spot with an "X" for the pilot bit to penetrate. If a saber saw is to be used, scribe the circumference of the hole with a compass, or trace the outline of the outside edge of the trim ring (not available for 4" threaded deck plate models). A 3" deck plate requires a 3-3/4" (95mm) hole and a 4" deck plate requires a 4-3/4" (121mm) hole. Do not use the deck plate as a template, as it

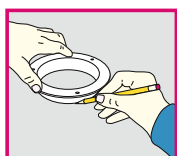
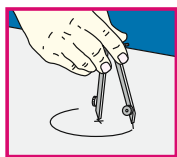

Installing The Day&Night 2000

measures a 1/4" (6mm) less than the required cutout diameter for the installation hole.

NOTE: For 4" threaded deck plate models, a 4-3/8" (111mm) diameter hole is required.

TIP: If you are installing the Day&Night 2000 using the saber saw method and are concerned about scratching the deck or hatch with the base plate of the saw follow this tip: Select your installation location and, before scribing the circumference, cover the entire area with wide masking tape. Scribe the circumference on top of the tape. The tape will protect the installation surface while you are cutting the hole.

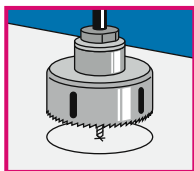

STEP TWO: CUTTING THE HOLE

Using a Hole Saw

If you are cutting the hole with a hole saw, we recommend the use of a variable speed drill. Cutting the hole at a lower RPM will ensure that the hole is not cut too quickly, which can melt the plastic on a hatch. Follow the directions for the drill motor itself and be sure it is properly grounded. A slow, steady speed is preferred. Be sure to stop and clean out the hole and the hole saw periodically.

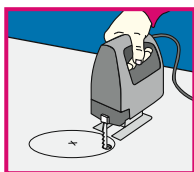

Using a Saber Saw

To cut the hole with a saber saw, select a blade that is compatible with the material you are cutting (fiberglass, wood, acrylic etc.). Be sure the saw is properly grounded. Drill a pilot hole near the inside edge of the scribed circumference that is big enough to insert the saw blade into. Insert the saw blade into the hole and slowly start cutting out to the scribed circumference. Cut carefully to avoid mistakes, breaking the blade, or melting the plastic on a hatch. Always cut right on your line or just outside of it.

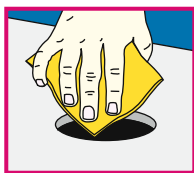

Finishing the Hole

Sand the edge of the hole smooth so that the trim ring and deck plate fit properly. Test fit the entire unit. If the deck is cored with wood or foam, seal the exposed edge of the material with epoxy to prevent moisture from penetrating into the core.

Installing The Day&Night 2000

NOTE: Most hatches are made of acrylic which is very durable. Even older acrylic is easy to cut and will not chip or crack as long as the proper tools and methods are used.

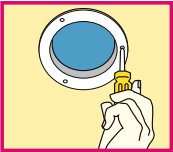

STEP THREE: INSTALLING INTERIOR TRIM RING

The trim ring is **NOT** available for 4" threaded deck plate models.

Deck Mount

For decks having a thickness of 1" (25mm) or more, place the trim ring into the hole from the interior side and mark the three fastener holes. Make sure the holes do not lie directly beneath the holes to be drilled for the deck plate installation in Step 4. Remove trim ring and drill out the holes with a 5/32" bit. Place trim ring back into hole to ensure correct alignment. Fasten the trim ring into place with three #10x3/4" flat head screws provided. For decks having a thickness less than 1", the Micro spacer ring is required (#N10863SP for a 3" vent, or #N10864SP for a 4" vent) or the trim ring can be left off. If desired, the Micro soft vinyl protective ring (#N10863PR for a 3" vent, or #N10864PR for a 4" vent) can be installed with contact cement to cover the protruding portion of the deck plate.

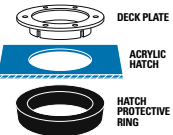
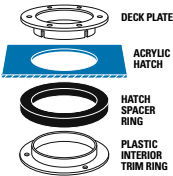

Hatch Mount

The interior trim ring can be left off for a hatch mount, or the Micro soft vinyl protective ring (#N10863PR for a 3" vent, or #N10864PR for a 4" vent) can be installed to cover the protruding portion of the deck plate. To install the interior trim ring on a hatch which is less than 1" (25mm) thick, the Micro spacer ring (#N10863SP for a 3" vent, or #N10864SP for a 4" vent) is required. **CAUTION:** Do not use the #10 sheet metal screws to install the trim ring in an acrylic hatch as this may cause the hatch to crack.



STEP FOUR: INSTALLING THE DECK PLATE

It is important to rough up the bonding surfaces between the deck plate and hatch or deck to get a good water-tight seal. Use 100-grit sandpaper around the edge of the installation hole and around the bottom of the flange on the deck plate.

Deck Installation

Place the deck plate into the hole from the outside to mark the six (6) fastener holes. Mark the fasteners holes making sure they

Installing The Day&Night 2000

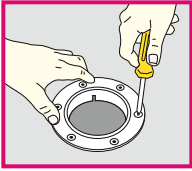

do not interfere with the trim ring holes in step three. Remove the deck plate and drill 5/32" holes. Do not penetrate all the way through the deck. Place deck plate back into hole to insure correct alignment. Bed the deck plate and the #10x3/4" flat head screws provided with silicone or polyurethane sealant (polyurethane for a cambered deck). Caution: Use shorter length screws if your deck is less than 3/4" (19mm) thick. DO NOT over-tighten the screws. Install the trim ring first, then the deck plate, using only a HAND-HELD screwdriver.

Hatch Installation

Fastener holes are not required for hatch installations if the deck plate is to be glued to the hatch. If machine screws (not provided) are to be used, drill 7/32" clearance holes completely through the material using the deck plate as a template to mark the center location of the holes.

To glue the deck plate to a hatch, apply a 1/4" (7mm) bead of polyurethane bedding compound around the bottom of the flange on the deck plate. Rotate the deck plate into the hole as you are pressing it into place. This will insure a proper seat. Polyurethane needs to cure thoroughly for maximum strength; depending on the brand, this can take up to a few days.

If you choose to use fasteners to install the deck plate, use #10 machine screws with a Nylock nut and washer (not provided). Insert the machine screws all the way through the 7/32" holes. Be sure to apply silicone sealant to the deck plate and also to the machine screws so that the threads do not "weep" water below during wash down, rain or heavy spray. Tighten the screws by hand (not a power-driver), and make them snug but not tight enough to crack the deck ring. Allow silicone sealant

to cure thoroughly to insure a watertight seal. Install the trim ring (and optional spacer) first (Step 3), then the deck plate, using only a HAND-HELD screwdriver.

CAUTION: Do not use the #10 sheet metal screws provided with this unit on a hatch installation as they may crack the hatch. Machine screws with clearance holes are required.

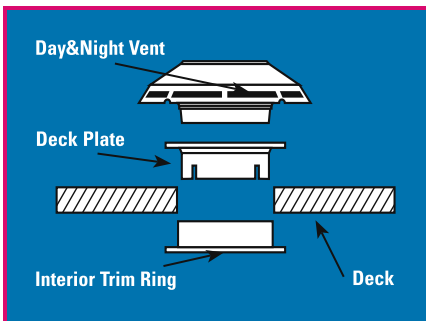
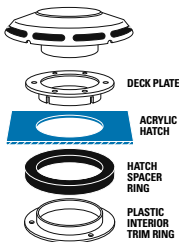

Installing The Day&Night 2000

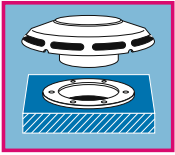

STEP FIVE: INSTALLING VENT TO DECK PLATE

Be sure the O-ring gasket is seated on the base of the fan housing. Just press the vent firmly into the deck plate until it seats. If you have difficulty, try rotating or twisting the vent as you press it into place.

To remove the vent, grasp the outer edge with the fingertips of two hands and gently twist and pull up.

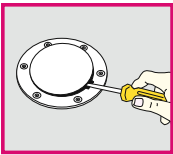

The Day&Night 2000 comes with a Snap-In watertight cover that can be pressed into the deck plate to seal the opening when the vent has been removed. To remove the cover, insert a thin blade screwdriver into one of the slots on the deck plate and gently pry up.

FEATURES & OPERATION

Intake & Exhaust Fan Blades

The Day&Night 2000 comes with two fan blades, one intake and one exhaust. The Day&Night 2000 comes with the exhaust fan already installed on the vent. Each fan blade is labeled on the hub with either a red dot for intake or a blue dot for exhaust. To install or exchange fan blades, simply stop fan blade by gently pressing on the hub to slow the fan blade down. Pull the existing fan blade off and push the new one on, making sure you have the colored dot showing.

Caution: A straight pull or push of the fan blade should be exerted to ensure that you do not bend the motor shaft. When replacing the fan blade be sure that the fan blade is not pressed against the motor housing, as this will cause the fan to bind reducing performance.

On the 3" Day&Night 2000 be careful not to pull the fan blade out too far or it may rub on the damper screw bosses. If you have only one vent installed on your boat, we recommend using the exhaust fan blade; if you have multiple vents try different configurations of intake and exhaust to achieve effective cross flow ventilation.



IF YOU HAVE ANY QUESTIONS FAX OR CALL OUR CUSTOMER SERVICE DEPARTMENT (SEE BACK COVER)

Installing The Day&Night 2000

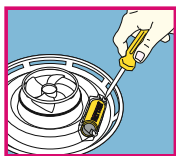

Ni-Cad Battery

The Day&Night 2000 comes with a charged Ni-Cad battery. To install the battery, turn the vent over, remove the screws on the battery case, install the battery and replace the screws (do not over-tighten). Make sure that when re-closing the battery case that the gasket is in place to prevent water from causing battery corrosion. Allow the vent to charge in the sun (not under a light bulb) for 24 to 36 hours. This will insure a fully-charged battery. *(Depending on angle to the sun, weather conditions and shadowing of the solar array, the time necessary to charge the battery may vary.)*

MAINTENANCE

We recommend that you periodically clean the solar array with a mild cleaner to insure the vent charges continuously. Also, clean the electrical contacts inside the battery case, especially the positive (+) battery contact periodically. Use the flat surface of a pencil eraser, or if heavier build-up has occurred, use either a fine emery cloth or fine sandpaper. If after a few years of operation the battery is no longer performing at peak performance, replace it with a Ni-Cad C-Cell rated at 2.0 amp-hours or greater (# N20590).

TROUBLE SHOOTING / If the Day&Night 2000 stops running:

• Check the Battery

The battery may be dead. A dead battery short circuits the solar array and will not deliver power to the motor. Test the Day&Night 2000 without the battery in it by placing the array in direct sun to see if the motor turns. If the motor turns, the battery is dead. Replace the battery with a C size Ni-Cad battery with a minimum rating of 2.0 amp-hours (#N20590). Be sure to clean the battery contacts before installing a new battery to remove any oxidation.

• Check the Solar Array & Fan Motor

If the motor still did not turn when the battery was removed, either the array is damaged or the motor does not work. Contact Micro customer service for warranty repair or replacement.

• If the Deck Plate is Leaking Below

When the deck plate is new and you have a leak in rain, spray or wash down, most likely the deck plate is not installed properly. We recommend that it be removed and re-installed according to the instruction guidelines. However, the use of silicone sealant or silicone grease can cure an annoying drip without having to re-install the deck plate.

Installing The MiniVent 1000



MiniVent 1000 Components:

- MiniVent 1000 Solar Vent with Shut-Off Damper
- Interior Trim Ring
- Insect Screen
- 3 #10x3/4" Flat Head Screws
- 3 #6 Pan Head Self-Tapping Screws

To ensure that you successfully complete your MiniVent 1000 installation, carefully follow these instructions. Make sure to review the following **Precautions and Problem Areas to Avoid** before you begin.

PRECAUTIONS

The MiniVent 1000 installs directly to the deck or hatch surface of your boat with self-tapping screws. The installation hole must be at least 3-3/4" (95mm) in diameter and the vent can be retro-fitted to an existing hole of up to 6" (152mm) in diameter. There are three (3) important factors that must be properly addressed to insure a good vent installation:

1. Make sure the base of the vent is properly caulked when fastening it to the deck or hatch. We recommend using 1/4" to 1/2" (7mm-12mm) wide bead of silicone sealant.
2. The installation hole must be cut to 3-3/4" (95mm) in diameter so that the surface around the vent base is not distorted and the interior trim ring will fit. Measure carefully to cut the 3-3/4" (95mm) hole.
3. When installing the vent on a cambered surface, make sure you do not tighten the fasteners too much; this will distort the base of the vent and may cause the vent to leak.

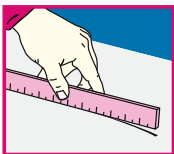

VERY CRITICAL: DECK CAMBER (or deck curvature)

When installing the MiniVent 1000 on a cambered, or curved, surface, it is critical to check to make sure there is no more than 1/2" (12mm) of camber over a 12" (300mm) length of deck surface. Too much camber will distort the base of the unit, causing the cover to be raised off the deck. This creates the potential for water to get under the cover and may also prevent the damper from closing properly.

To check for camber, place a 12" (300mm) straight edge on the deck location for the vent and try to rock it. Then rotate it 90 degrees and repeat.

Installing The MiniVent 1000

PROBLEM AREAS TO AVOID

Cut the hole for your MiniVent 1000 only after carefully considering the location and the correct sizing of the hole. We recommend that you **MEASURE TWICE AND CUT ONCE!**

DO NOT install the MiniVent 1000 in an area with more than 1/2" of camber over a 12" length of deck surface.

Be careful that the location you select for the through-deck hole does not go through any electrical wiring, plumbing or other obstructions. Be sure power tools are properly grounded.

Take the time to bed the vent base and fasteners properly with sealant.

INSTALLING The MiniVent 1000 IN A HATCH OR THROUGH THE DECK

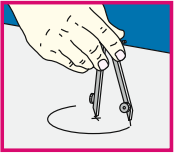

STEP ONE: MARKING THE HOLE

When mounting on a deck, make sure to check the camber of the deck. See Precautions.

Carefully choose the installation location. If a hole saw is to be used, simply mark the center of the installation spot with an "X" for the pilot bit to penetrate. If a saber saw is to be used, scribe the circumference of the hole with a compass or trace the outline of the outside edge of the trim ring.

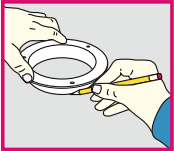

NOTE: The MiniVent 1000 requires a 3-3/4" (95mm) diameter hole.

TIP: If you are installing the MiniVent 1000 using the saber saw method and are concerned about scratching the deck or hatch with the base plate of the saw follow this tip: Select your installation location and, before scribing the circumference, cover the entire area with wide masking tape. Scribe the circumference on top of the tape. The tape will protect the installation surface while you are cutting the hole.

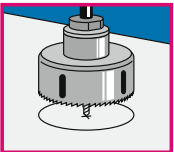

STEP TWO: CUTTING THE HOLE

Using a Hole Saw

If you are cutting the hole with a hole saw, we recommend the use of a variable speed drill. Cutting the hole at a lower RPM will ensure that the hole is not cut too quickly, which can melt the

Installing The MiniVent 1000

plastic on a hatch. Follow the directions for the drill motor itself and be sure it is properly grounded. A slow, steady speed is preferred. Be sure to stop and clean out the hole and the hole saw periodically.

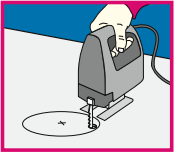

Using a Saber Saw

To cut the hole with a saber saw, select a blade that is compatible with the material you are cutting (fiberglass, wood, acrylic etc.). Be sure the saw is properly grounded. Drill a pilot hole near the inside edge of the scribed circumference that is big enough to insert the saw blade into. Insert the saw blade into the hole and slowly start cutting out to the scribed circumference. Cut carefully to avoid mistakes, breaking the blade, or melting the plastic on a hatch. Always cut right on your line or just outside of it.

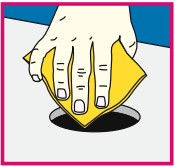

Finishing the Hole

Sand the edge of the hole smooth so that the trim ring and base plate fit properly. Test fit the entire unit. If the deck is cored with wood or foam, seal the exposed edge of the material with epoxy to prevent moisture from penetrating into the core.

NOTE: Most hatches are made of acrylic which is very durable. Even older acrylic is easy to cut and will not chip or crack as long as the proper tools and methods are used.

STEP THREE: INSTALLING INTERIOR TRIM RING

Deck Mount

For decks having a thickness of 1" (25mm) or more, place the trim ring into the hole from the interior side and mark the three fastener holes. Remove trim ring and drill out the holes with a 5/32" bit. Place trim ring back into hole to ensure correct alignment. Fasten the trim ring into place with three #10x3/4" flat head screws provided. For decks having a thickness less than 1", the Nicro spacer ring is required (#N10863SP), or the trim ring can be left off. If desired, the Nicro soft vinyl protective ring (#N10863PR) can be installed with contact cement to cover the protruding portion of the fan housing.

Hatch Mount

The interior trim ring can be left off for a hatch mount, or the Nicro soft vinyl protective ring (#N10863PR) can be pressed around the protruding portion of the fan housing. To install the interior trim ring on a hatch which is less than 1" (25mm) thick, the Nicro spacer ring (#N10863SP) is required.

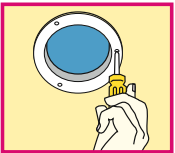

Installing The MiniVent 1000

CAUTION: Do not use the #10 flat head sheet metal screws to install the trim ring in an acrylic hatch as this may cause the hatch to crack.

STEP FOUR: INSTALLING THE VENT UNIT

It is important to rough up the bonding surfaces between the base of the unit and hatch or deck to get a good water-tight seal. Use 100 grit sandpaper around the edge of the installation hole and around the bottom of the unit.

Deck Installation

There are three drain holes on the vent base; one is larger than the other two and should be installed facing aft or towards the downward angle. It is labeled "AFT." Bed the base of the unit and the #6 pan head self-tapping screws provided with silicone or polyurethane sealant (regular silicone seal is recommended for flat surfaces and polyurethane for a cambered deck). Place the vent into the hole from the outside and attach it to the deck with the three #6 pan head self-tapping screws provided. **CAUTION:** Use shorter length screws if your deck is less than 5/8" (16mm) thick. **DO NOT** over-tighten the screws. Install the trim ring first, then the vent, using only a HAND-HELD screwdriver.

Hatch Installation

Fastener holes are not required for hatch installations if the vent is to be glued to the hatch with polyurethane. If fastener holes are to be used, drill 5/32" clearance holes completely through the material.

To glue the vent to a hatch, apply a generous bead of polyurethane bedding compound around the bottom of the vent. Rotate the vent into the hole as you are pressing it into place. This will insure a proper seal. Polyurethane needs to cure thoroughly for maximum strength; depending on the brand, this can take up to a few days. If you choose to use fasteners to install the vent, use #6 machine screws with a Nylock nut and washer (not provided). Drill three holes all the way through the acrylic hatch **OVERSIZED** to 5/32". Insert the machine screws all the way through the 5/32" holes. When silicone sealer is applied to the machine screws, the use of an oversized hole will create a shock absorber so the screws will not damage the hatch. Be sure to apply silicone sealer to the base of the unit and also to the machine screws so

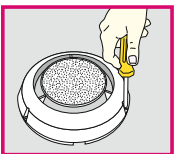
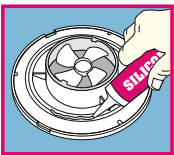
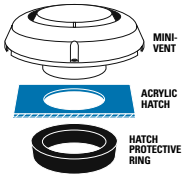
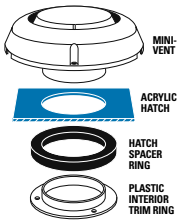

Installing The MiniVent 1000

that the threads do not “weep” water below during wash down, rain or heavy spray.

Tighten the screws by hand (not a power-driver), and make them snug but not tight enough to crack the unit. Allow silicone to cure thoroughly to insure a watertight seal. **CAUTION: Do not use the #6 pan head screws provided with this unit on a hatch installation as they may crack the hatch.** Machine screws with clearance holes are required. Install the trim ring (and optional spacer) first, then the vent, using only a HAND-HELD screw-driver.



FEATURES

An optional Micro stainless steel cover (#N28830) is available for the MiniVent 1000. It attaches directly over the top of the vent with three #6 self-tapping screws. When installing the stainless steel cover, be sure to align the drain holes in the cover with those in the vent.

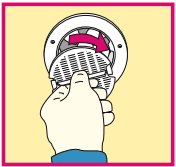

The MiniVent 1000 comes with a removable insect screen that attaches to the shut-off damper. The screen is easy to install by grasping the fin in the center and carefully twisting it on in a clock-wise motion. The screen must be removed when opening

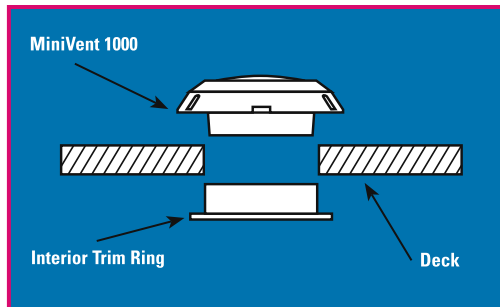

the damper or you may break the tabs on the damper. If the shut-off damper becomes difficult to operate, apply a little silicone grease around the perimeter.

MAINTENANCE

The fan blade should be cleaned periodically. To remove it for cleaning, gently pull it away from the motor. It will slide off the shaft. To replace the fan, simply push it back on to the motor shaft.

CAUTION: A straight pull or push of the blade should be exerted to ensure that you do not bend the motor shaft.

Installing The MiniVent 1000

When replacing the fan blade be sure that the fan blade is not pressed against the motor housing, as this will cause the fan to bind and reduce performance. It is also recommended to periodically clean the solar array with a mild cleaner to ensure optimum performance.

IF YOU HAVE ANY QUESTIONS FAX OR CALL OUR CUSTOMER SERVICE DEPARTMENT (SEE BACK COVER)

Installing The AirVent 500



To install the AirVent 500 follow the instructions on page 32 (same installation as for the MiniVent 1000). Follow steps one and two for marking and cutting the hole. Follow step three only if you are installing the interior trim ring. The AirVent 500 does not come with the 3" interior trim ring. If you wish to install the interior trim ring, it must be purchased separately (#N10866). Follow step four to install the vent unit into the installation hole.



(Optional interior trim ring #N10866)

The AirVent 500 features a built-in shut-off damper. The damper operates from below by sliding the damper out to open or sliding it in to close.

The AirVent 500's translucent center allows light to pass below.



(Optional stainless steel cover ring #N28830)

An optional Nicro stainless steel cover (#N28830) is available for the AirVent 500. It attaches directly over the top of the vent with three #6 self-tapping screws. When installing the stainless steel cover, be sure to align the drain holes in the cover with those in the vent.

DO NOT install the AirVent 500 in an area with more than 1/2" of camber over a 12" length of deck surface.

Installing The Combo & 12 Volt Vents

INSTALLING

The Two-Speed 12V Vent & The Combo 12V/Solar Vent

The Nicro Two-Speed 12V Vent vent can be installed in any position including vertically because it does not rely on solar power for its operation. The Nicro Combo 12V/Solar Vent should be mounted on a horizontal surface for effective use of the solar array. Both vents install using the Nicro 4" deck plate. Refer to the Day&Night installation instructions starting on page 25 for instructions on measuring and cutting the installation hole, installing the interior trim ring and installing the 4" deck plate. If you have any questions concerning proper wiring and wiring techniques, we recommend that you consult a qualified marine electrician who can install or inspect your wiring.

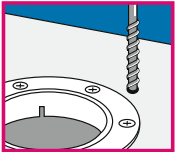

INSTALLING THE WIRING

Pay close attention to the color coding on all wiring.

Drill a 3/16" hole in the deck next to the deck plate. Determine the location of the cable switchbox assembly (CSA) in the cabin. If needed, route the stranded connecting wire (not included) from the CSA to the vent location. We recommend the use of a marine quality 16 gauge duplex stranded wire (tinned preferred) with adequate insulation. Pull the wires through the 3/16" hole out onto the deck, leaving a length of about 6" (150mm) above deck to facilitate the hook-up.

Wiring the Two-Speed 12 Volt Vent

Remove 5/8" of insulation from the wires in the black coded 2-wire cable on the vent and on the hook-up wires. Connect the red insulated wire (+) to the red and the black insulated wire (-) to the black.

Wiring Diagram for the Two-Speed 12 Volt Vent

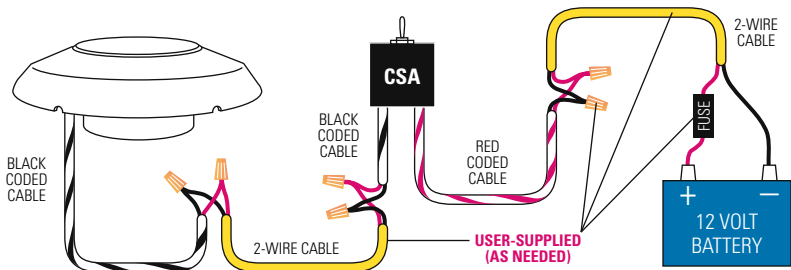

Installing Combo & 12 Volt Vents

Wiring The Combo 12 Volt/Solar Vent

Remove 5/8" of insulation from the wires in the green coded 3-wire cable on the vent and on the hook-up wires. Connect the red insulated wire (+) to the red, the black insulated wire (-) to the black and the green to the green.

Wiring Diagram for the Combo 12 Volt/Solar Vent

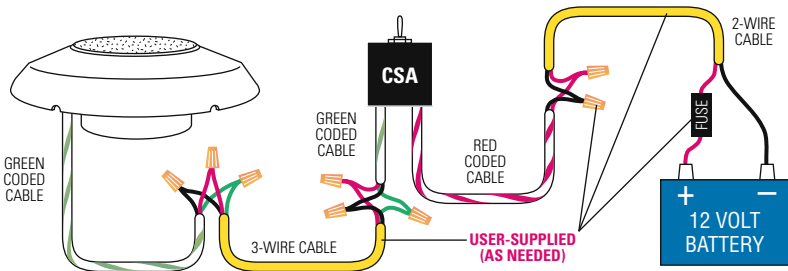

The CSA for the Two-Speed 12 Volt Vent has three positions, from left to right: LO, OFF, HI

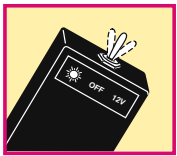

The CSA for the Combo 12 Volt/Solar Vent has three positions, from left to right: SOLAR, OFF, 12V DC

Twist the wires together and install the orange twist locks (wire nuts). Using the twist locks will make it easier to remove the vent. Feed the wires back through the deck to remove the slack leaving the twist locks and a short length of wire above deck. Seal the 3/16" hole with silicone sealer. The remaining slack can be loosely wrapped around the ventilator housing (clear plastic) before inserting the vent into the deck plate.

Attach the connecting wire to the CSA (black switch box) in the same manner. For the Two-Speed 12 Volt Vent use the black coded 2-wire cable from the CSA. For the Combo 12 Volt/Solar Vent use the green coded 3-wire cable from the CSA. **Never connect the Combo vent directly to a 12V battery as this will burn out the vent motor.** The CSA, which has an internal current limiting resistor, must be used. All solder joints or crimp-type /quick disconnect type connections must be well insulated to prevent short circuits. Wire lengths up to 20 - 30 feet (6-9 meters) will cause a very slight reduction in fan output. Connect the CSA to the 12 volt power supply with the red coded 2-wire cable. Connect the red insulated wire to the positive (+) side of the power supply and the black insulated wire to the negative (-) side. To aid in the wiring we recommend the use of the Marincos Battery Direct Connect (#12VTR) or the Marincos Busbar Direct Connect (#12VBB) multi connection terminals to connect the wiring to the battery or busbar. We recommend that a low current fuse or circuit breaker of 1 Amp or less be installed between the CSA and the power source.

Installing Combo & 12 Volt Vents

It is very important that when wiring the Two-Speed 12 Volt Vent you are certain that you have the correct electrical polarity in all connections. Improper wiring will cause the fan to operate in the opposite direction at reduced capacity. Continued operation in this manner will significantly reduce the life of the motor.

Intake & Exhaust Fan Blades

See Day&Night installation instructions on page 25 for information about fan exchange. When the fan is to be exchanged or removed for cleaning, be sure the CSA is in the "OFF" position. It would be prudent to shut off the power at the protective circuit breaker on the main electrical panel as well. Never insert your finger into the fan while it is in operation.

Switch Maintenance

The switch on the CSA should be periodically exercised to remove any oxidation that might build up on the contacts by rapidly moving the switch back and forth through all positions 6 to 8 times.

NOTE: It is normal for the switch to become warm after extended operation.

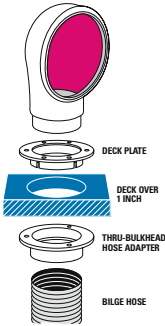
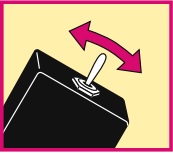

Installing Cowl Vents

Nicro Cowl Vents install using the same Snap-In deck plates as the Day&Night 2000. Please refer to the instructions beginning on page 25 for deck camber, marking and cutting the hole and installing the deck plate. The 3" snap-in cowl vent requires a 3-3/4" installation hole, the 4" snap-in cowl vent requires a 4-3/4" installation hole. The 3" threaded cowl requires a 3-3/8" installation hole; the 4" threaded cowl requires a 4-3/8" installation hole.

How The Nicro Water Trap (#N27200) Works

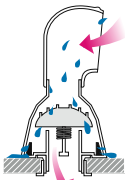

When rain or spray enters the water trap it is directed across the damper and out the weep holes.



When green water enters the water trap the weight of the water forces down the damper closing the trap 100%.

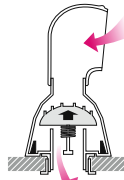

When the green water has drained out the weep holes the damper pops back up and ventilation resumes.

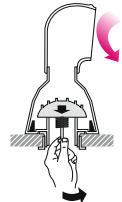

The damper can be completely shut off from below by pulling down the damper arm and rotating 1/4 turn.

Nicro Warranty

TO THE VENTILATOR OWNER:

Congratulations! The Nicro solar powered and/or 12V DC ventilator you have just purchased is the result of years of research and testing, both in the laboratory and on the water. We use only the highest quality components assembled by skilled workers in the USA. We are so confident that our product will give you satisfactory service that we have extended our LIMITED WARRANTY period to TWO (2) years.

LIMITED WARRANTY

We warrant Nicro solar powered and/or 12V DC ventilators to be free from defects in workmanship or materials for a period of TWO (2) years from date of purchase. During warranty period, defects will be repaired or the defective ventilator will be replaced, at our option, without charge. This warranty does not cover damage through misuse or accident. All implied warranties are limited to the life of the LIMITED WARRANTY, which is a period of TWO (2) years after original purchase. Some states do not allow limitations on how long an implied warranty lasts. This warranty gives you specific legal rights and you may have other rights that vary from state to state.

For further information on repair or replacement policy, contact:

Nicro Ventilation Customer Service

2655 Napa Valley Corporate Drive

Napa, California 94558 USA

Phone: +1 707 226-9600 / Fax: +1 707 226-9670 / email:www.marinco.com

WARRANTY RETURN POLICY

If a Nicro solar powered and/or 12V DC ventilator is found to be defective within TWO (2) years after the original date of purchase, return it freight prepaid to Nicro Ventilation. Include a brief explanation of the problem and the shipping address to which repaired or replacement units should be shipped. Nicro Ventilation will promptly repair or replace, at our option, your unit and return it to you freight prepaid.

QUALIFIED WARRANTY

If a ventilator becomes inoperative after the expiration of the LIMITED WARRANTY period of TWO (2) years, but before FIVE (5) years after original purchase, you may return the ventilator to Nicro Ventilation and we will, at our option, either:

A. REPAIR AND RETURN THE UNIT TO YOU.

B. FURNISH A RECONDITIONED UNIT OF THE SAME MODEL AS RETURNED UNIT.

C. FURNISH A NEW UNIT OF THE SAME MODEL AS RETURNED UNIT.

Nicro ventilators covered under this QUALIFIED WARRANTY will be subject to a service, handling or repair charge equivalent to 40% of the retail price at the time of failure. Nicro Ventilation will ship the replacement prepaid within the Continental U.S.A.

ADDITIONAL NOTES

Do not attempt to repair or modify any Nicro Ventilation product in the field as this might affect your warranty protection. If a fan stops rotating, we do suggest that you check to make certain the fan blade has not been pushed up the motor shaft, towards the motor base. This can cause the fan blade to rub on the motor, preventing fan rotation. To remedy, simply pull the fan blade away from the motor base (approx. 1/16") until ventilator functions normally.

BATTERY

IMPORTANT: SPECIAL HANDLING IS REQUIRED WHEN DISPOSING OF NI-CAD BATTERIES.

PowerVent 3000 and Day and Night 2000 vent models have a removable battery. If you replace your **Ni-Cad** battery, please recycle or dispose of it correctly.

Please call +1-800-555-1212 to establish the battery manufacturer's recycling point in your state.

WARRANTY CARD

To assure you receive full warranty protection, kindly fill out the warranty card and return it to Nicro Ventilation within TEN (10) days of purchase.

**For Additional Information
or Answers to Installation
Questions Please Contact:**

Nicro Customer Service

Phone: +1 707 226-9600

Fax: +1 707 226-9670

Or visit our website:

www.marinco.com