

2019 Outboard Rigging and Parts



YAMAHA OUTBOARD SALES IN U.S.A.

Reliability Starts Here.®





Description	Page
Single Engine	
Single Engine with Mechanical Side Mount Controls	2-1
Single Engine with Mechanical Binnacle Controls	2-8
Single Engine With DEC Flush Mount Controls	2-17
Single Engine With DEC Binnacle Controls	2-21
Twin Engines	
Twin Engines with Mechanical Binnacle Controls	2-26
Twin Engines with DEC Controls	2-29
Triple Engines	
Triple Engines with Mechanical Binnacle Controls	2-34
Triple Engines with DEC Controls	2-35
Command Link® and Command Link Plus® Accessories	
Adding a Multi-Hub	2-39
Adding the Gateway	2-39
Adding the AGI (Analog Gauge Interface)	2-41
Adding a MultiSensor	2-42
Y-COP® Installations	
Y-COP® with Single Engine	2-43
Y-COP® with Twin/Triple Engines with Command Link® Switches	2-44
Y-COP® with Twin/Triple Engines with Command Link Plus® Switches	2-45

General
Information

Rigging Estimate
Guide (Diagrams)

Rigging
Components

Electrical
Components

Engine
Accessories

Propellers

Maintenance
Items

Oils
& Lubes

Detailing &
Trailer Supplies

Accessories
& Apparel

Generators
& Accessories

Rigging Estimate Guide

General Information

Rigging Estimate Guide (Diagrams)

Rigging Components

Electrical Components

Engine Accessories

Propellers

Maintenance Items

Oils & Lubes

Detailing & Trailer Supplies

Accessories & Apparel

Generators & Accessories

Single Engine with Mechanical Side Mount Controls - Analog Gauges

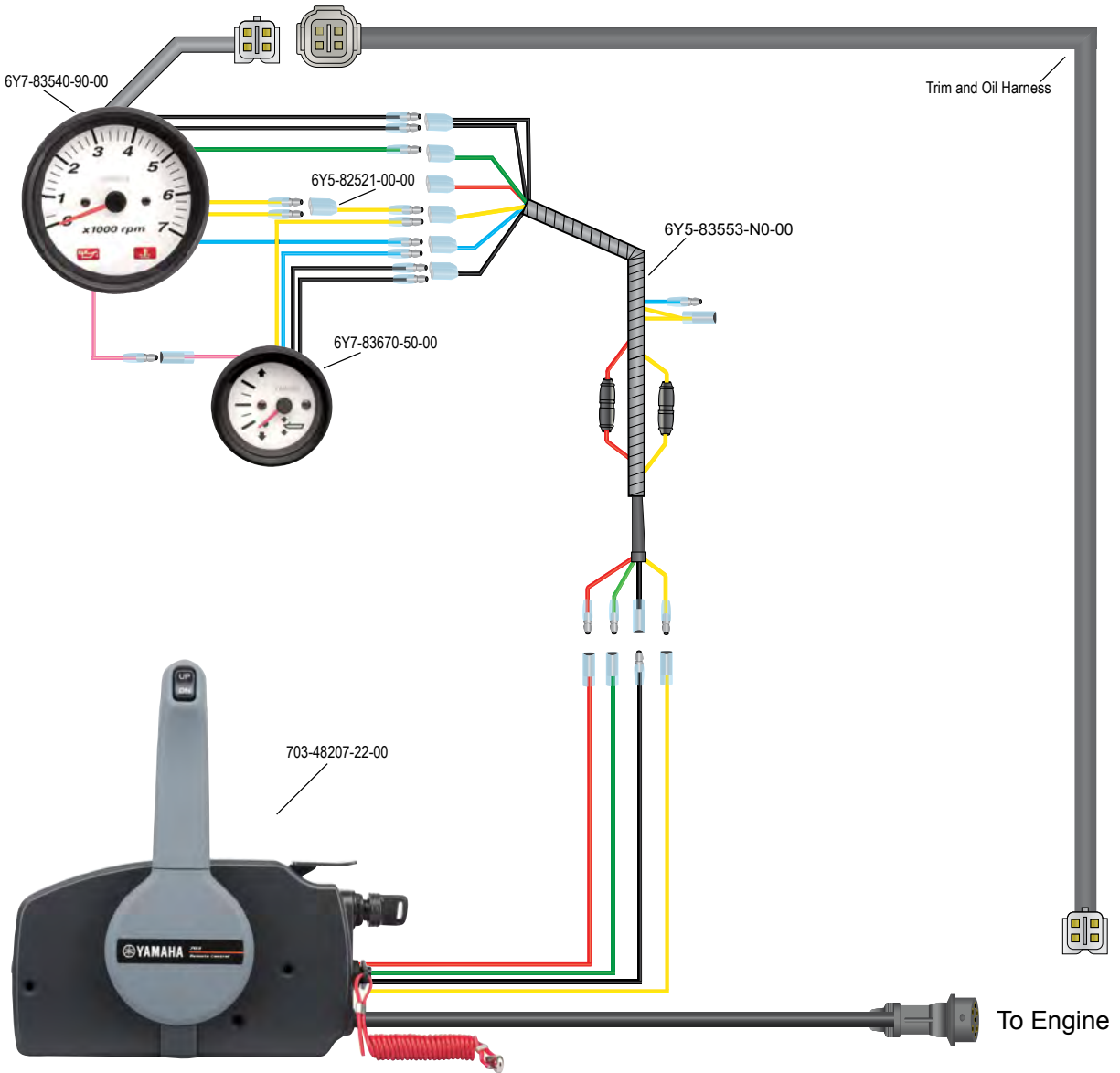

Parts order list for basic installation:

Quantity	Description	Part Number
1	703 Side Mount Control with 10 Pin Harness	703-48207-22-00
1	Analog Tachometer	6Y7-83540-90-00
1	Analog Trim Meter	6Y7-83670-50-00
1	Dual Fuse Harness	6Y5-83553-N0-00
1	Yellow Wire Extension	6Y5-82521-00-00
1	2005~ Trim and Oil Harness	See List ¹

¹ 2005~ Trim and Oil Harness

16.4 ft.	6Y5-83653-00-00
19.7 ft.	6Y5-83653-10-00
23 ft.	6Y5-83653-20-00
26.3 ft.	6Y5-83653-30-00
30 ft.	6Y5-83653-40-00
35 ft.	6Y5-83653-50-00

Single Engine with Mechanical Side Mount Controls - Analog Gauges

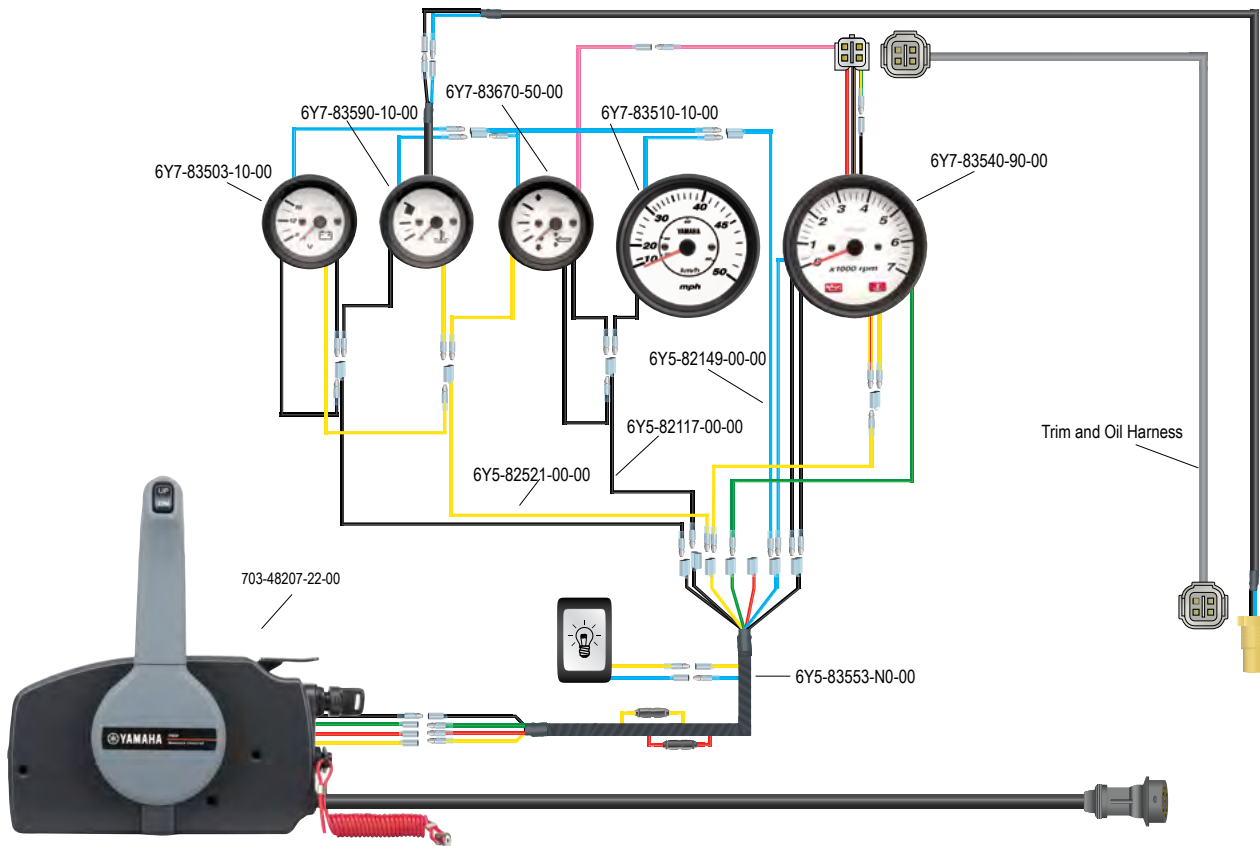

Parts order list for basic installation:

Quantity	Description	Part Number
1	703 Side Mount Control with 10 Pin Harness	703-48207-22-00
1	Analog Tachometer	6Y7-83540-90-00
1	Analog Speedometer	6Y7-83510-10-00
1	Analog Trim Meter	6Y7-83670-50-00
1	Analog Water Temp Gauge	6Y7-83590-10-00
1	Analog Volt Meter	6Y7-83503-10-00
1	Water Pressure Sender	688-83667-00-00
1	Dual Fuse Harness	6Y5-83553-N0-00
2	Yellow Wire Extension	6Y5-82521-00-00
2	Blue Wire Extension	6Y5-82149-00-00
2	Black Wire Extension	6Y5-82117-00-00
1	2005~ Trim and Oil Harness	See List ¹

¹ 2005~ Trim and Oil Harness

16.4 ft.	6Y5-83653-00-00
19.7 ft.	6Y5-83653-10-00
23 ft.	6Y5-83653-20-00
26.3 ft.	6Y5-83653-30-00
30 ft.	6Y5-83653-40-00
35 ft.	6Y5-83653-50-00

General Information

Rigging Estimate Guide (Diagrams)

Rigging Components

Electrical Components

Engine Accessories

Propellers

Maintenance Items

Oils & Lubes

Detailing & Trailer Supplies

Accessories & Apparel

Generators & Accessories

Rigging Estimate Guide

Single Engine with Mechanical Side Mount Controls - Multifunction Gauges

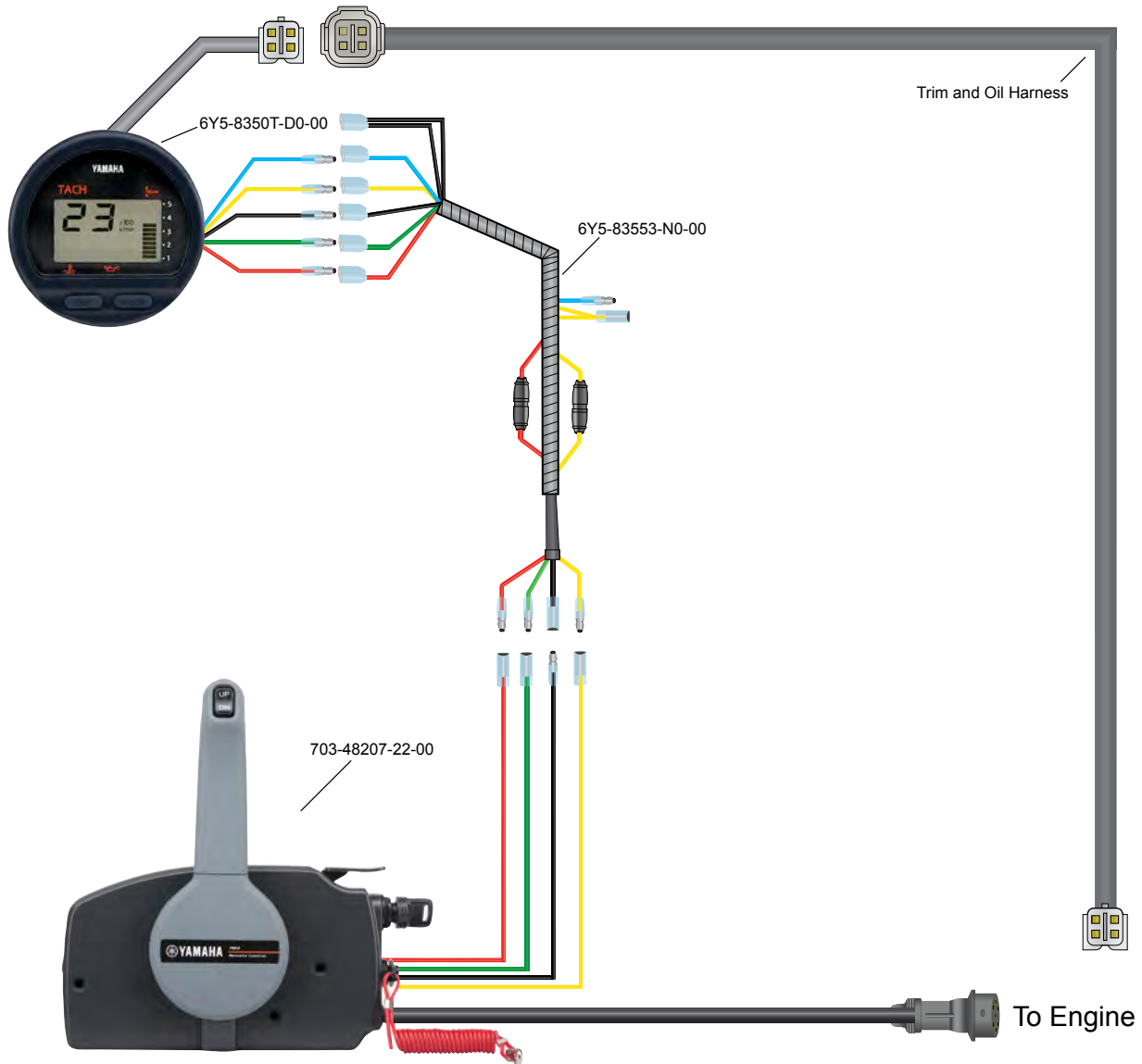

Parts order list for basic installation:

Quantity	Description	Part Number	¹ 2005~ Trim and Oil Harness	
1	703 Side Mount Control with 10 Pin Harness	703-48207-22-00	16.4 ft.	6Y5-83653-00-00
1	Multifunction Tachometer Kit	6Y5-8350T-D0-00	19.7 ft.	6Y5-83653-10-00
1	Dual Fuse Harness	6Y5-83553-N0-00	23 ft.	6Y5-83653-20-00
1	Trim and Oil Harness	See List ¹	26.3 ft.	6Y5-83653-30-00
			30 ft.	6Y5-83653-40-00
			35 ft.	6Y5-83653-50-00

Single Engine with Mechanical Side Mount Controls - Command Link®

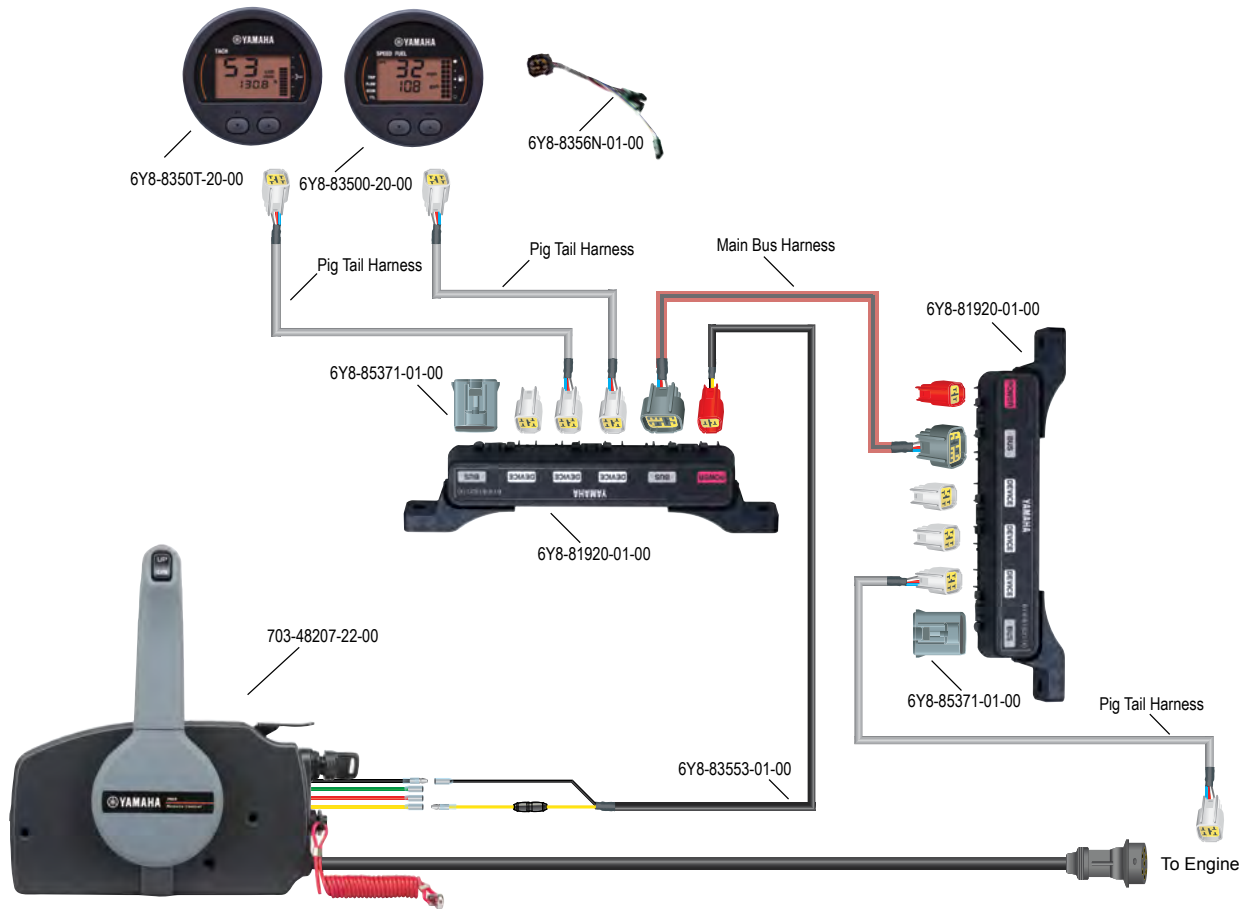

Parts order list for basic installation:

Quantity	Description	Part Number
1	703 Side Mount Control with 10 Pin Harness	703-48207-22-00
1	Command Link Tachometer	6Y8-8350T-20-00
1	Command Link Speed / Fuel Gauge	6Y8-83500-20-00
2	Multi-Hub Assembly	6Y8-81920-01-00
1	Power Lead, 8 ft.	6Y8-83553-01-00
1	Cap, 2 Pin	6Y8-82582-01-00
3	Cap, 4 Pin	6Y8-82582-11-00
1	Speed Sensor Kit	60V-8A4L1-18-00
1	Fuel Sender and GPS Wire Lead	6Y8-8356N-01-00
1	Pigtail Harness, Engine to Rear Hub, 12 ft.	6Y8-82521-51-00
2	Pigtail Harness, Hub to Gauge	See List ¹
1	Main Bus Hub, Rear Hub to Front Hub	See List ²

¹Pigtail Harnesses

1 ft.	6Y8-82521-01-00
2 ft.	6Y8-82521-11-00
3 ft.	6Y8-82521-21-00
6 ft.	6Y8-82521-31-00
9 ft.	6Y8-82521-41-00
12 ft.	6Y8-82521-51-00

²Main Buss Harnesses

1 ft.	6Y8-82553-01-00
10 ft.	6Y8-82553-50-00
15 ft.	6Y8-82553-11-00
20 ft.	6Y8-82553-21-00
25 ft.	6Y8-82553-31-00
30 ft.	6Y8-82553-41-00

General Information

Rigging Estimate Guide (Diagrams)

Rigging Components

Electrical Components

Engine Accessories

Propellers

Maintenance Items

Oils & Lubes

Detailing & Trailer Supplies

Accessories & Apparel

Generators & Accessories

Single Engine with Mechanical Flush Mount Controls - Multifunction Gauges

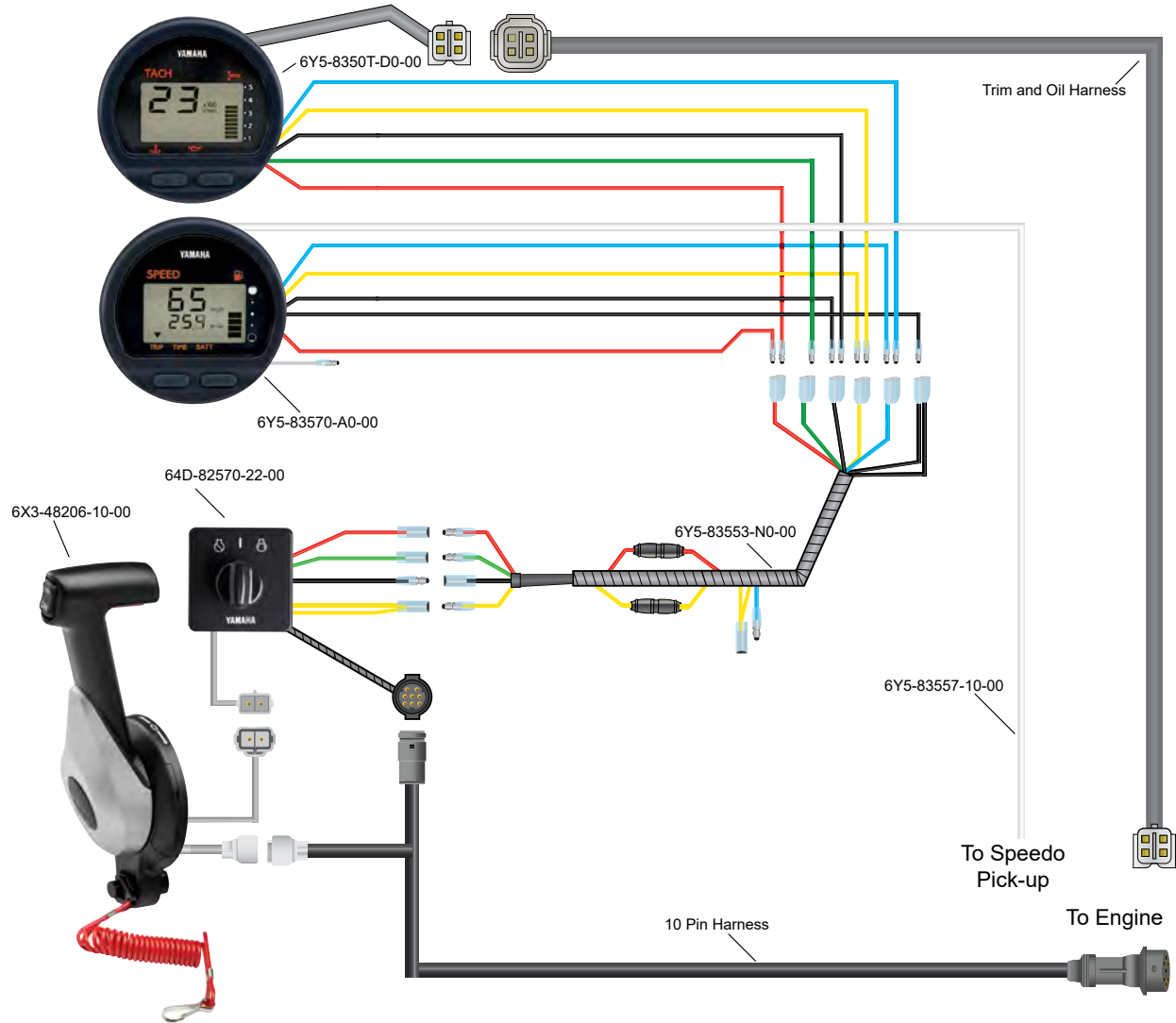

Parts order list for basic installation:

Quantity	Description	Part Number
1	6X3 Premium Flush Mount Control Box	6X3-48206-10-00
1	Single Engine Key Switch	64D-82570-22-00
1	Multifunction Tachometer	6Y5-8350T-D0-00
1	Multifunction Speedometer	6Y5-83570-A0-00
1	Speedometer Tube, 8.0 m	6Y5-83557-10-00
2	Clamp	90465-10098-00
10	Clamp	90465-13M39-00
1	Dual Fuse Harness	6Y5-83553-N0-00
1	10-Pin Main Harness	See List ¹
1	Trim and Oil Harness (2005~)	See List ²

¹ 10-Pin Harnesses

16 ft.	688-8258A-50-00
20 ft.	688-8258A-60-00
23 ft.	688-8258A-70-00
26 ft.	6K1-8258A-40-00
31.2 ft.	61B-8258A-01-00

² 2005~ Trim and Oil Harness

16.4 ft.	6Y5-83653-00-00
19.7 ft.	6Y5-83653-10-00
23 ft.	6Y5-83653-20-00
26.3 ft.	6Y5-83653-30-00
30 ft.	6Y5-83653-40-00
35 ft.	6Y5-83653-50-00

Single Engine with Mechanical Flush Mount Controls - Multifunction Gauges

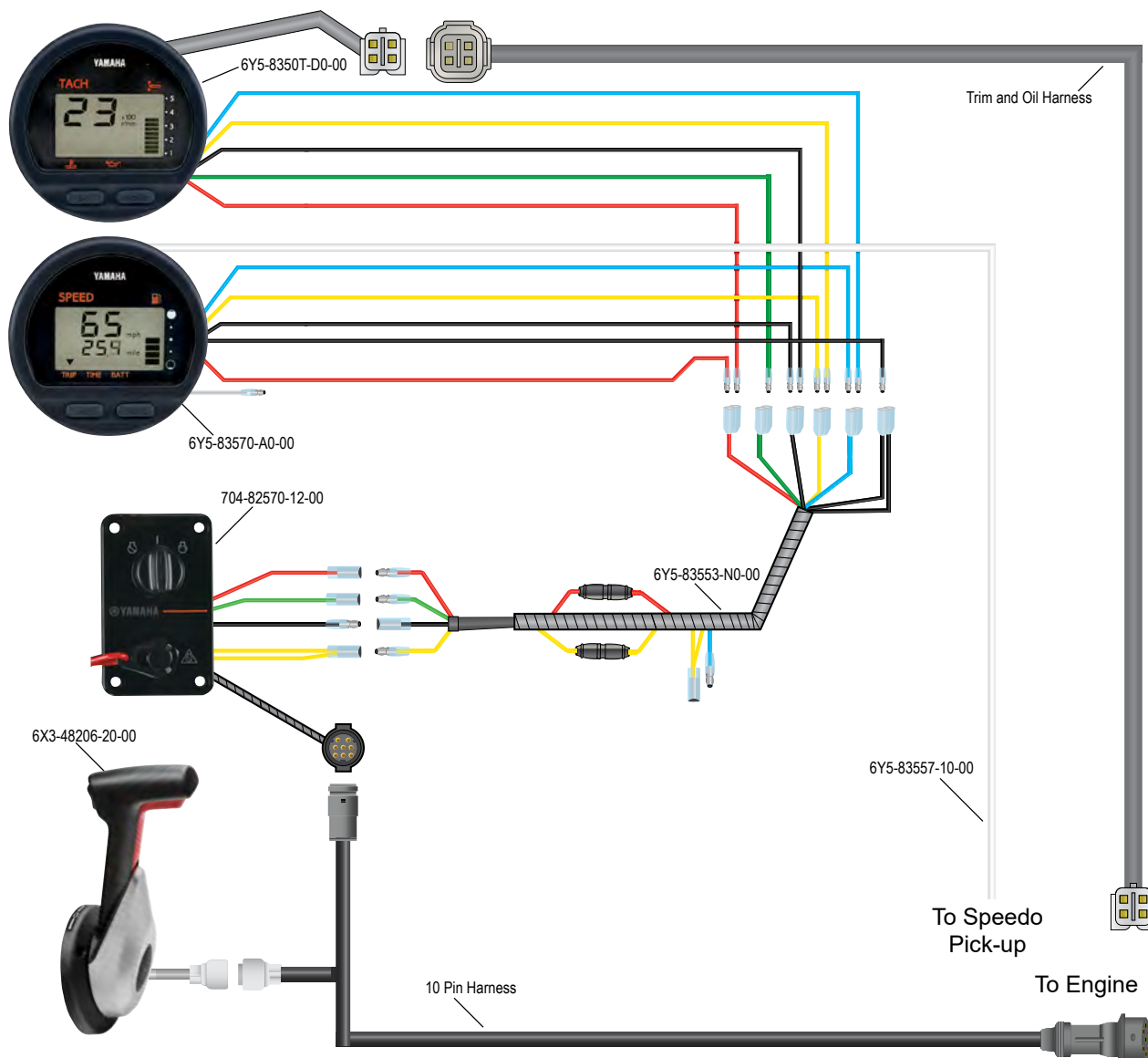

Parts order list for basic installation:

Quantity	Description	Part Number
1	6X0 Standard Flush Mount Control	6X0-48206-12-00
1	Single Engine Key Switch	704-82570-12-00
1	Multifunction Tachometer	6Y5-8350T-D0-00
1	Multifunction Speedometer	6Y5-83570-A0-00
1	Speedometer Tube, 8.0 m	6Y5-83557-10-00
2	Clamp	90465-10098-00
10	Clamp	90465-13M39-00
1	Dual Fuse Harness	6Y5-83553-N0-00
1	10-Pin Main Harness	See List ¹
1	Trim and Oil Harness (2005~)	See List ²

¹ 10-Pin Harnesses

16 ft.	688-8258A-50-00
20 ft.	688-8258A-60-00
23 ft.	688-8258A-70-00
26 ft.	6K1-8258A-40-00
31.2 ft.	61B-8258A-01-00

² 2005~ Trim and Oil Harness

16.4 ft.	6Y5-83653-00-00
19.7 ft.	6Y5-83653-10-00
23 ft.	6Y5-83653-20-00
26.3 ft.	6Y5-83653-30-00
30 ft.	6Y5-83653-40-00
35 ft.	6Y5-83653-50-00

Single Engine with Mechanical Flush Mount Controls - 6YC Display

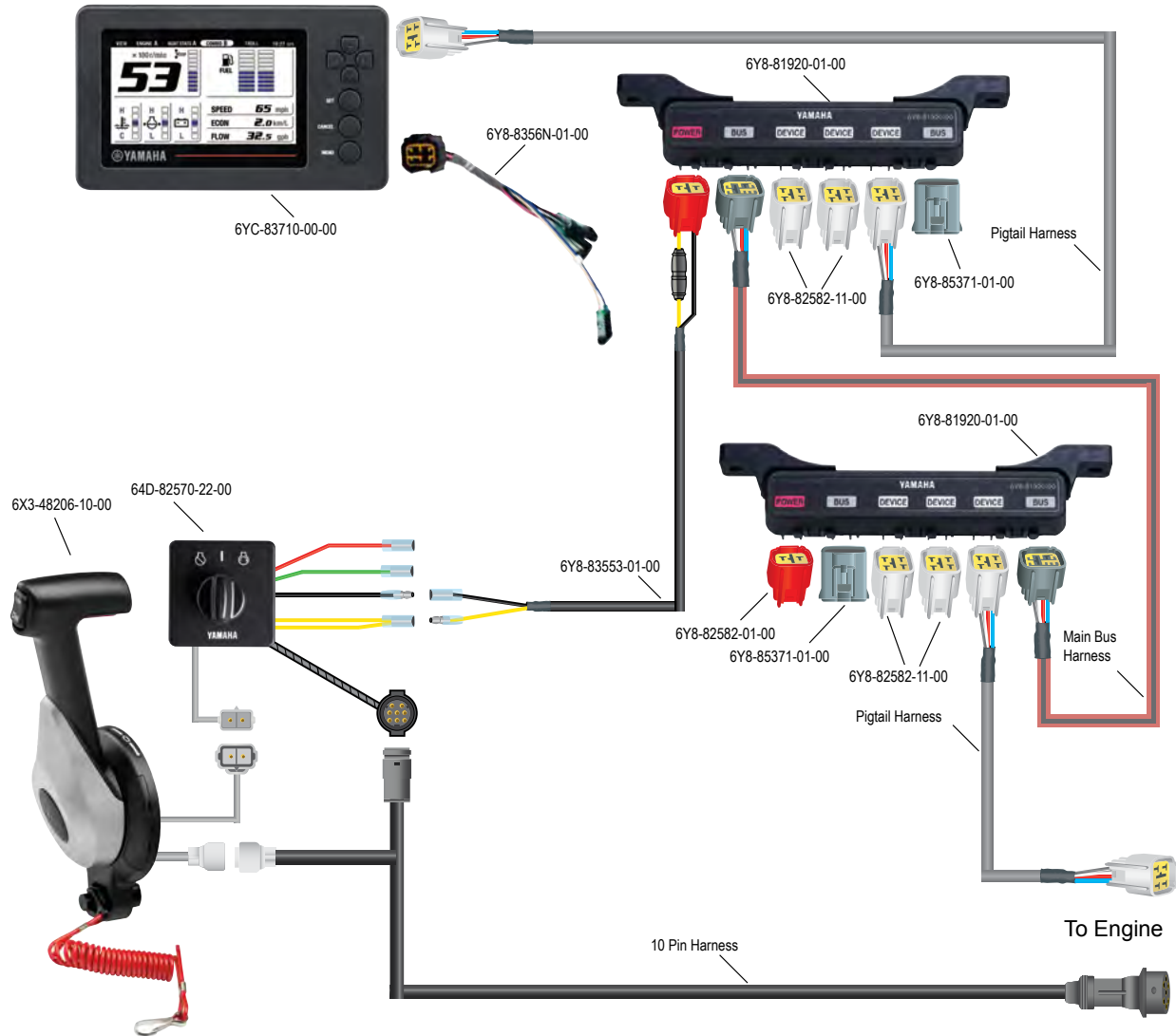

Parts order list for basic installation:

Quantity	Description	Part Number
1	6X3 Premium Flush Mount Control Box	6X3-48206-03-00
1	Single Engine Key Switch	64D-82570-22-00
1	6YC Display Kit	6YC-0E83C-00-00
1	10-Pin Main Harness	See List ¹
1	Main Buss Harness, Rear Hub to Front Hub	See List ²
1	Pigtail Harnesses, Front Hub to Display	See List ³

¹ 10-Pin Harnesses

16 ft.	688-8258A-50-00
20 ft.	688-8258A-60-00
23 ft.	688-8258A-70-00
26 ft.	6K1-8258A-40-00
31.2 ft.	61B-8258A-01-00

² Main Bus Harnesses

1 ft.	6Y8-82553-01-00
10 ft.	6Y8-82553-50-00
15 ft.	6Y8-82553-11-00
20 ft.	6Y8-82553-21-00
25 ft.	6Y8-82553-31-00
30 ft.	6Y8-82553-41-00

³ Pigtail Harnesses

1 ft.	6Y8-82521-01-00
2 ft.	6Y8-82521-11-00
3 ft.	6Y8-82521-21-00
6 ft.	6Y8-82521-31-00
9 ft.	6Y8-82521-41-00
12 ft.	6Y8-82521-51-00

Single Engine with Binnacle Controls - Multifunction Gauges

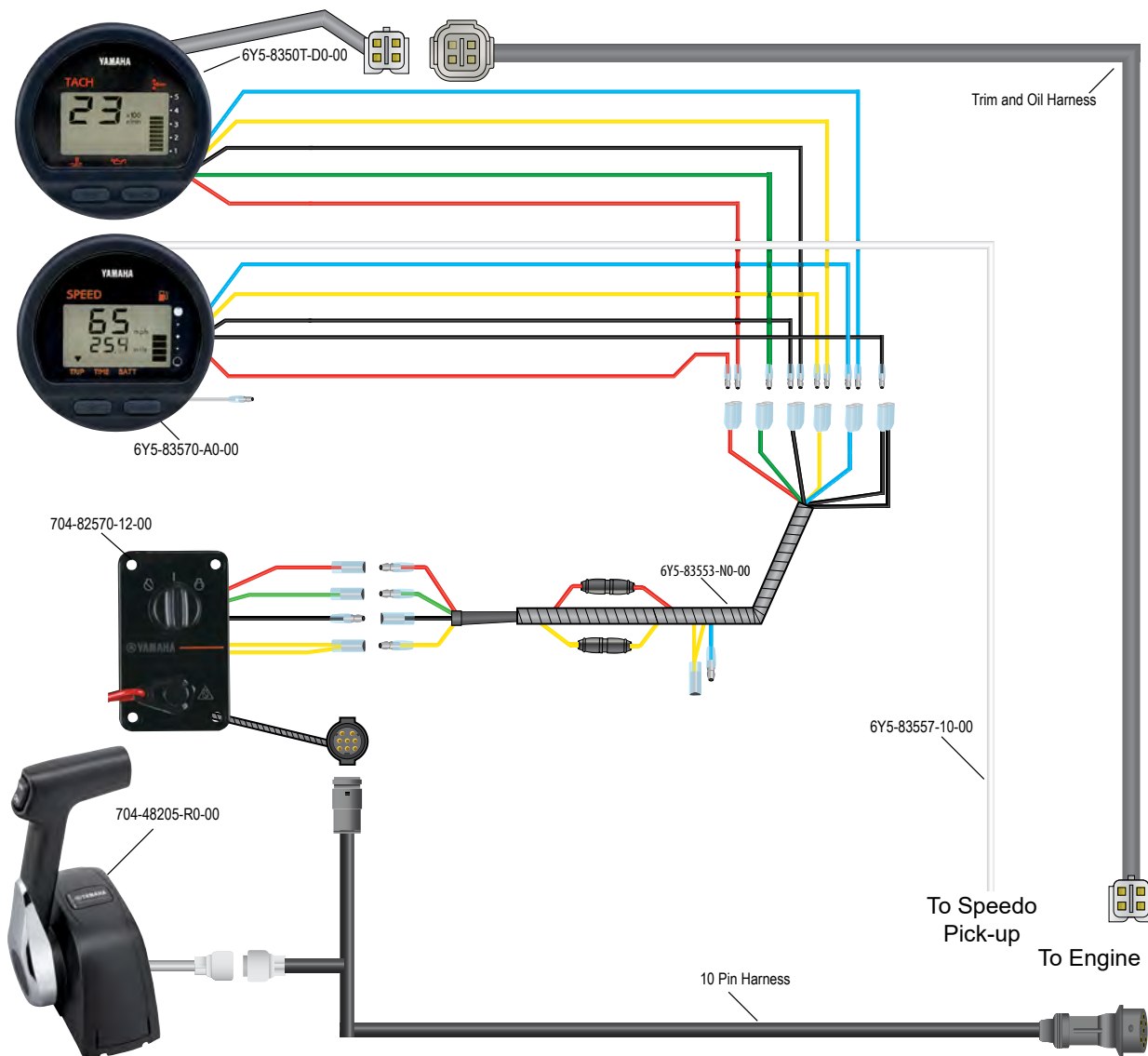

Parts order list for basic installation:

Quantity	Description	Part Number
1	Premium 704 Single Engine Binnacle Control Box	704-48205-R0-00
1	Single Engine Key Switch	704-82570-12-00
1	Multifunction Tachometer	6Y5-8350T-D0-00
1	Multifunction Speedometer	6Y5-83570-A0-00
1	Speedometer Tube, 8.0 m	6Y5-83557-10-00
2	Clamp	90465-10098-00
10	Clamp	90465-13M39-00
1	Dual Fuse Harness	6Y5-83553-N0-00
1	10-Pin Main Harness	See List ¹
1	Trim and Oil Harness (2005~)	See List ²

¹ 10-Pin Harnesses

16 ft.	688-8258A-50-00
20 ft.	688-8258A-60-00
23 ft.	688-8258A-70-00
26 ft.	6K1-8258A-40-00
31.2 ft.	61B-8258A-01-00

² 2005~ Trim and Oil Harness

16.4 ft.	6Y5-83653-00-00
19.7 ft.	6Y5-83653-10-00
23 ft.	6Y5-83653-20-00
26.3 ft.	6Y5-83653-30-00
30 ft.	6Y5-83653-40-00
35 ft.	6Y5-83653-50-00

Single Engine with Binnacle Controls - Command Link®

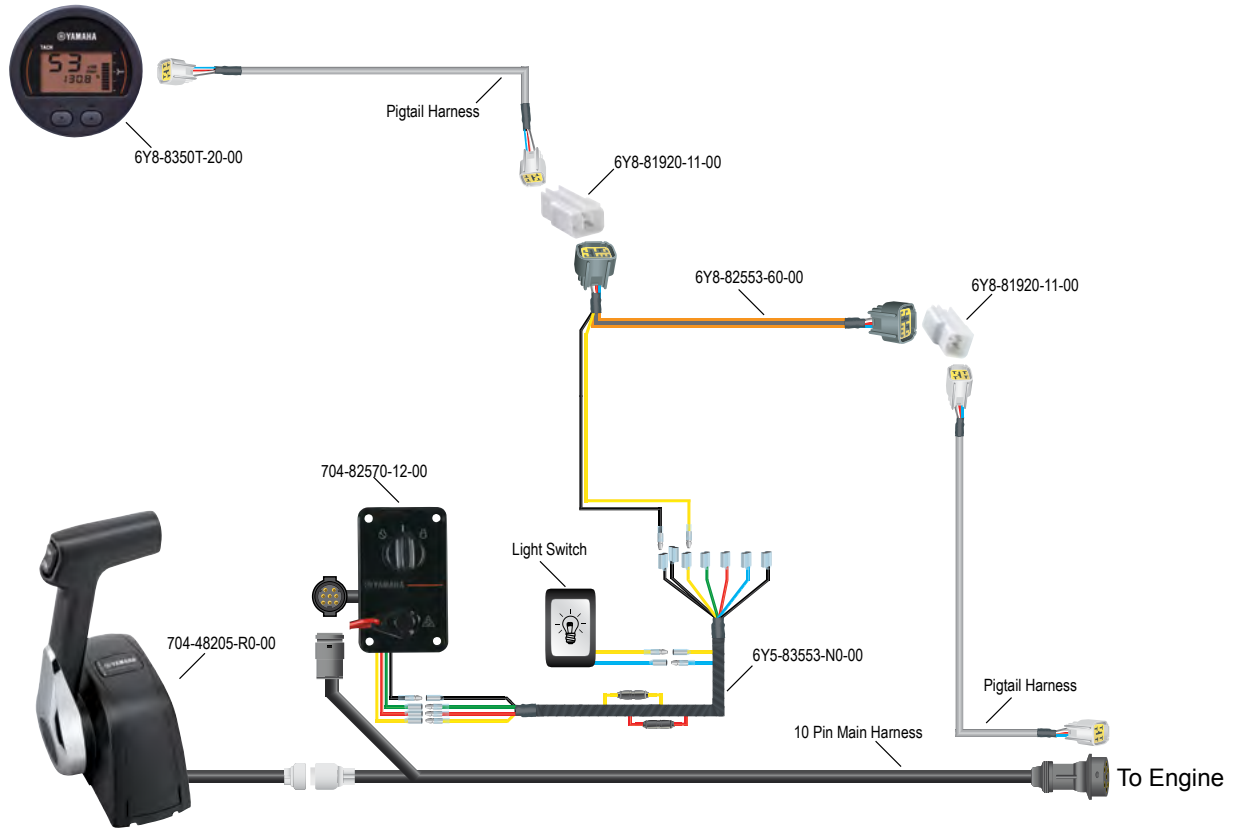

Parts order list for basic installation:

Quantity	Description	Part Number
1	Premium 704 Single Engine Binnacle Control Box	704-48205-R0-00
1	Single Engine Key Switch	704-82570-12-00
1	Command Link® Round Gauge Kit with In-line Hub	6Y8-0E83R-81-00
1	10-Pin Main Harness	See List ¹

¹ 10-Pin Harnesses

16 ft.	688-8258A-50-00
20 ft.	688-8258A-60-00
23 ft.	688-8258A-70-00
26 ft.	6K1-8258A-40-00
31.2 ft.	61B-8258A-01-00

Single Engine with Binnacle Controls - Command Link®

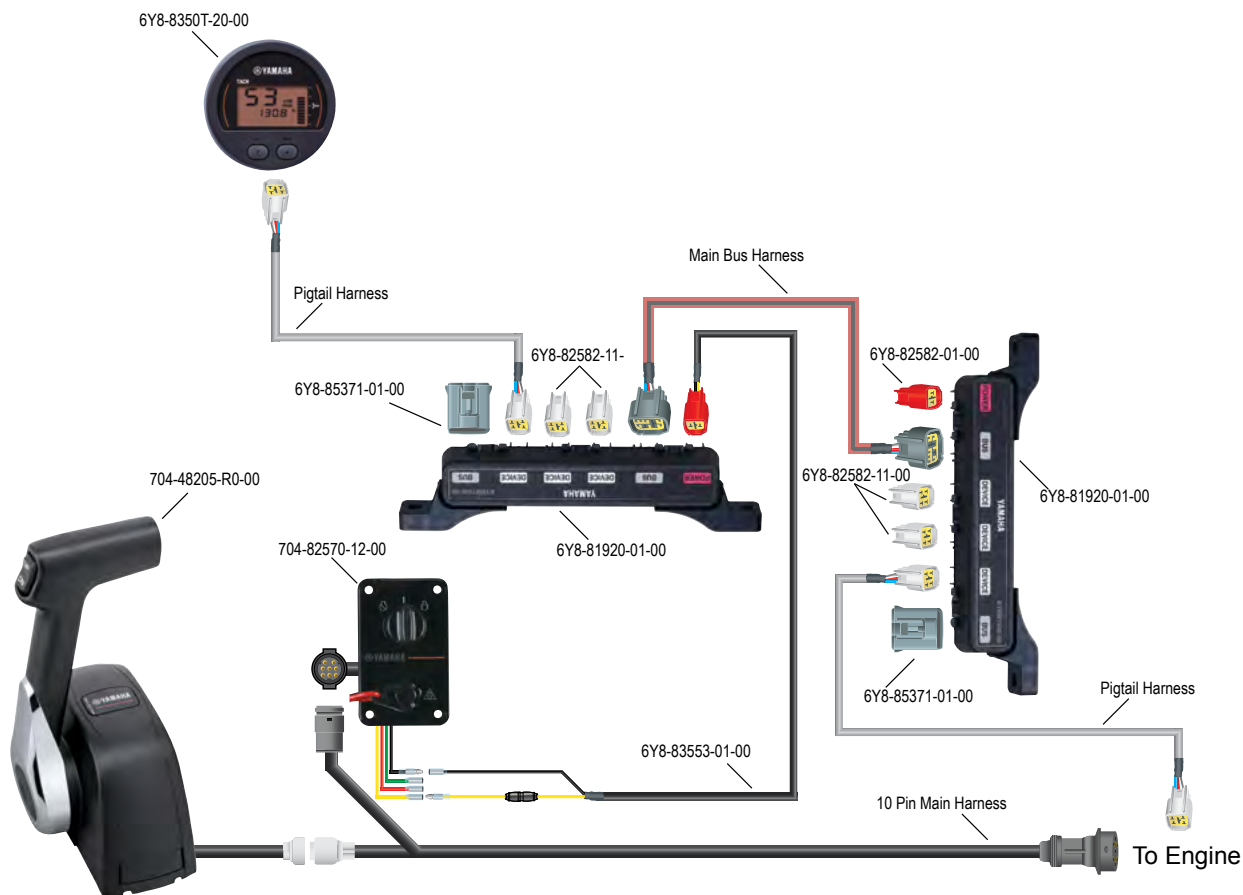

Parts order list for basic installation:

Quantity	Description	Part Number
1	Premium 704 Single Engine Binnacle Control Box	704-48205-R0-00
1	Single Engine Key Switch	704-82570-12-00
1	Command Link® Round One Gauge Kit	6Y8-0E83R-61-00
1	10-Pin Main Harness	See List ¹
1	Main Buss Harness, Rear Hub to Front Hub	See List ²
1	Pigtail Harnesses, Front Hub to Gauges	See List ³

¹ 10-Pin Harnesses

16 ft.	688-8258A-50-00
20 ft.	688-8258A-60-00
23 ft.	688-8258A-70-00
26 ft.	6K1-8258A-40-00
31.2 ft.	61B-8258A-01-00

² Main Bus Harnesses

1 ft.	6Y8-82553-01-00
10 ft.	6Y8-82553-50-00
15 ft.	6Y8-82553-11-00
20 ft.	6Y8-82553-21-00
25 ft.	6Y8-82553-31-00
30 ft.	6Y8-82553-41-00

³ Pigtail Harnesses

1 ft.	6Y8-82521-01-00
2 ft.	6Y8-82521-11-00
3 ft.	6Y8-82521-21-00
6 ft.	6Y8-82521-31-00
9 ft.	6Y8-82521-41-00
12 ft.	6Y8-82521-51-00

Single Engine with Binnacle Controls - Command Link®

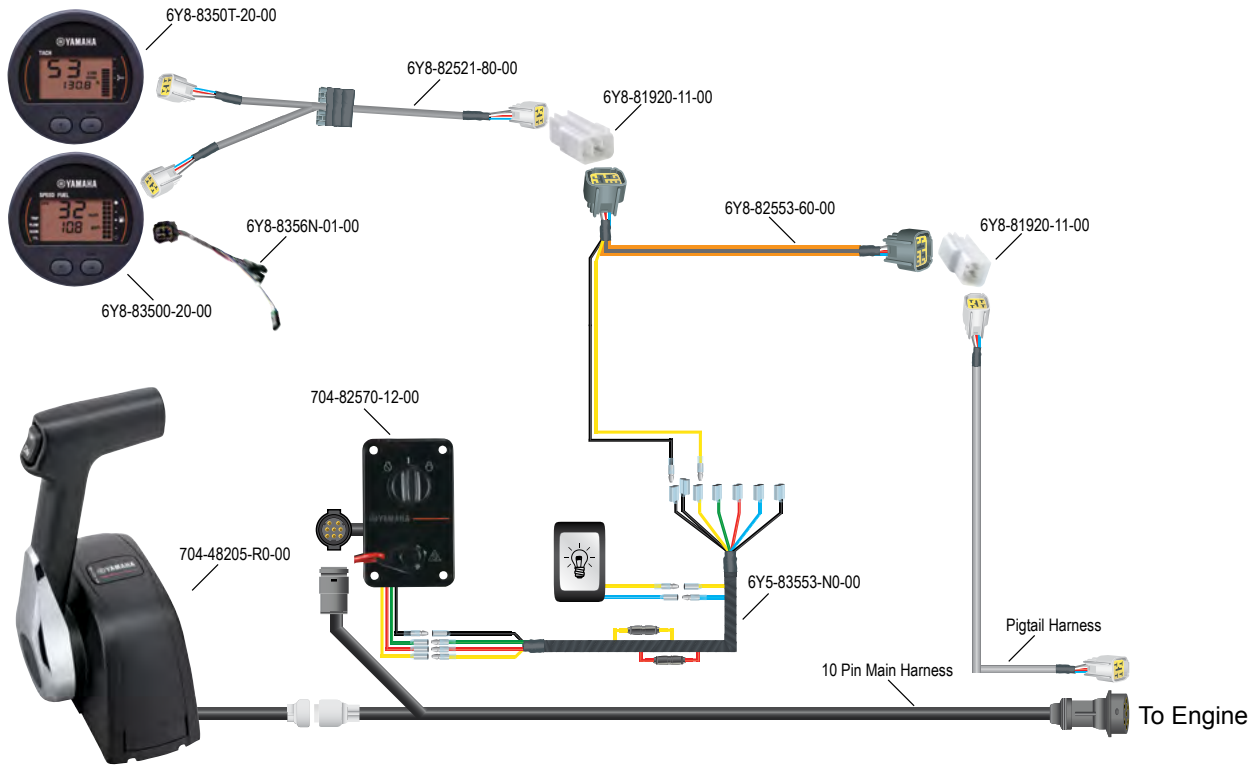

Parts order list for basic installation:

Quantity	Description	Part Number
1	Premium 704 Single Engine Binnacle Control Box	704-48205-R0-00
1	Single Engine Key Switch	704-82570-12-00
1	Command Link® Round Gauge Kit with In-line Hub	6Y8-0E83R-91-00
1	10-Pin Main Harness	See List ¹

¹ 10-Pin Harnesses

16 ft.	688-8258A-50-00
20 ft.	688-8258A-60-00
23 ft.	688-8258A-70-00
26 ft.	6K1-8258A-40-00
31.2 ft.	61B-8258A-01-00

Single Engine with Binnacle Controls - Command Link®

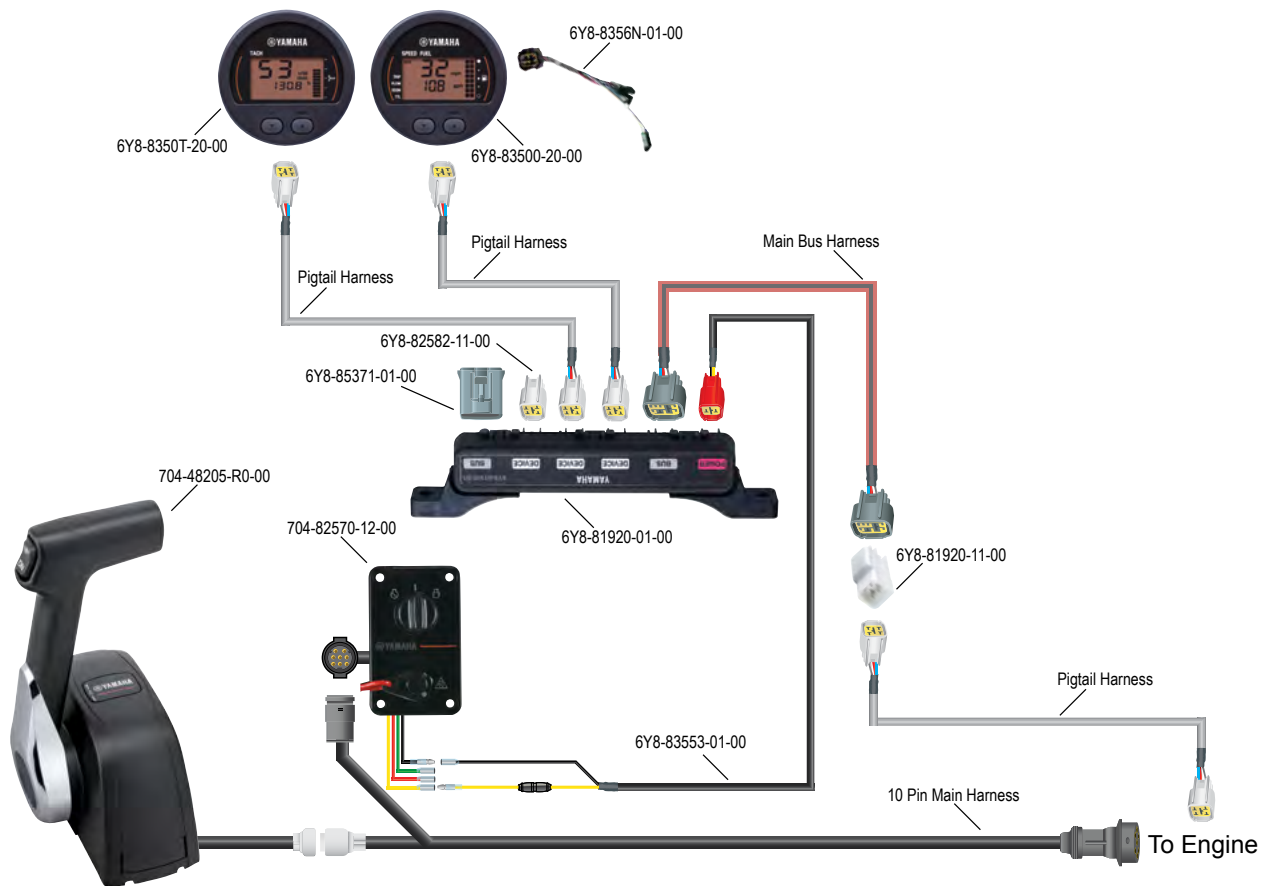

Parts order list for basic installation:

Quantity	Description	Part Number
1	Premium 704 Single Engine Binnacle Control Box	704-48205-R0-00
1	Single Engine Key Switch	704-82570-12-00
1	Command Link® Round Gauge Kit with In-line Hub	6Y8-0E83R-71-00
1	10-Pin Main Harness	See List ¹
1	Main Buss Harness, Rear In-line Hub to Front Hub	See List ²
2	Pigtail Harnesses, Front Hub to Gauges	See List ³

¹ 10-Pin Harnesses

16 ft.	688-8258A-50-00
20 ft.	688-8258A-60-00
23 ft.	688-8258A-70-00
26 ft.	6K1-8258A-40-00
31.2 ft.	61B-8258A-01-00

² Main Bus Harnesses

1 ft.	6Y8-82553-01-00
10 ft.	6Y8-82553-50-00
15 ft.	6Y8-82553-11-00
20 ft.	6Y8-82553-21-00
25 ft.	6Y8-82553-31-00
30 ft.	6Y8-82553-41-00

³ Pigtail Harnesses

1 ft.	6Y8-82521-01-00
2 ft.	6Y8-82521-11-00
3 ft.	6Y8-82521-21-00
6 ft.	6Y8-82521-31-00
9 ft.	6Y8-82521-41-00
12 ft.	6Y8-82521-51-00

Single Engine with Binnacle Controls - Command Link®

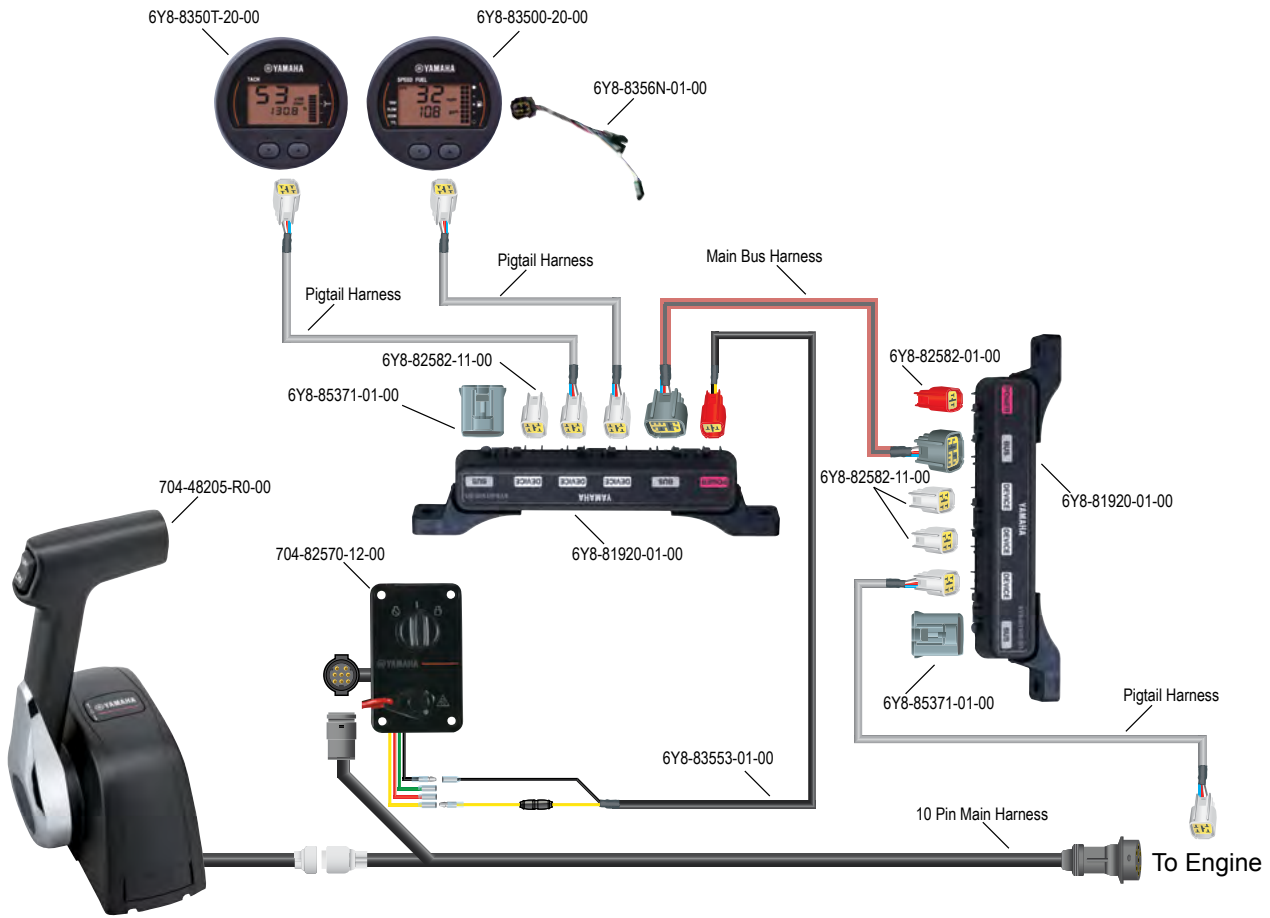

Parts order list for basic installation:

Quantity	Description	Part Number
1	Premium 704 Single Engine Binnacle Control Box	704-48205-R0-00
1	Single Engine Key Switch	704-82570-12-00
1	Command Link® Round Two Gauge Kit	6Y8-0E83R-41-00
1	10-Pin Main Harness	See List ¹
1	Main Buss Harness, Rear Hub to Front Hub	See List ²
2	Pigtail Harnesses, Front Hub to Gauges	See List ³

¹ 10-Pin Harnesses

16 ft.	688-8258A-50-00
20 ft.	688-8258A-60-00
23 ft.	688-8258A-70-00
26 ft.	6K1-8258A-40-00
31.2 ft.	61B-8258A-01-00

² Main Bus Harnesses

1 ft.	6Y8-82553-01-00
10 ft.	6Y8-82553-50-00
15 ft.	6Y8-82553-11-00
20 ft.	6Y8-82553-21-00
25 ft.	6Y8-82553-31-00
30 ft.	6Y8-82553-41-00

³ Pigtail Harnesses

1 ft.	6Y8-82521-01-00
2 ft.	6Y8-82521-11-00
3 ft.	6Y8-82521-21-00
6 ft.	6Y8-82521-31-00
9 ft.	6Y8-82521-41-00
12 ft.	6Y8-82521-51-00

Single Engine with Binnacle Controls - 6YC Display

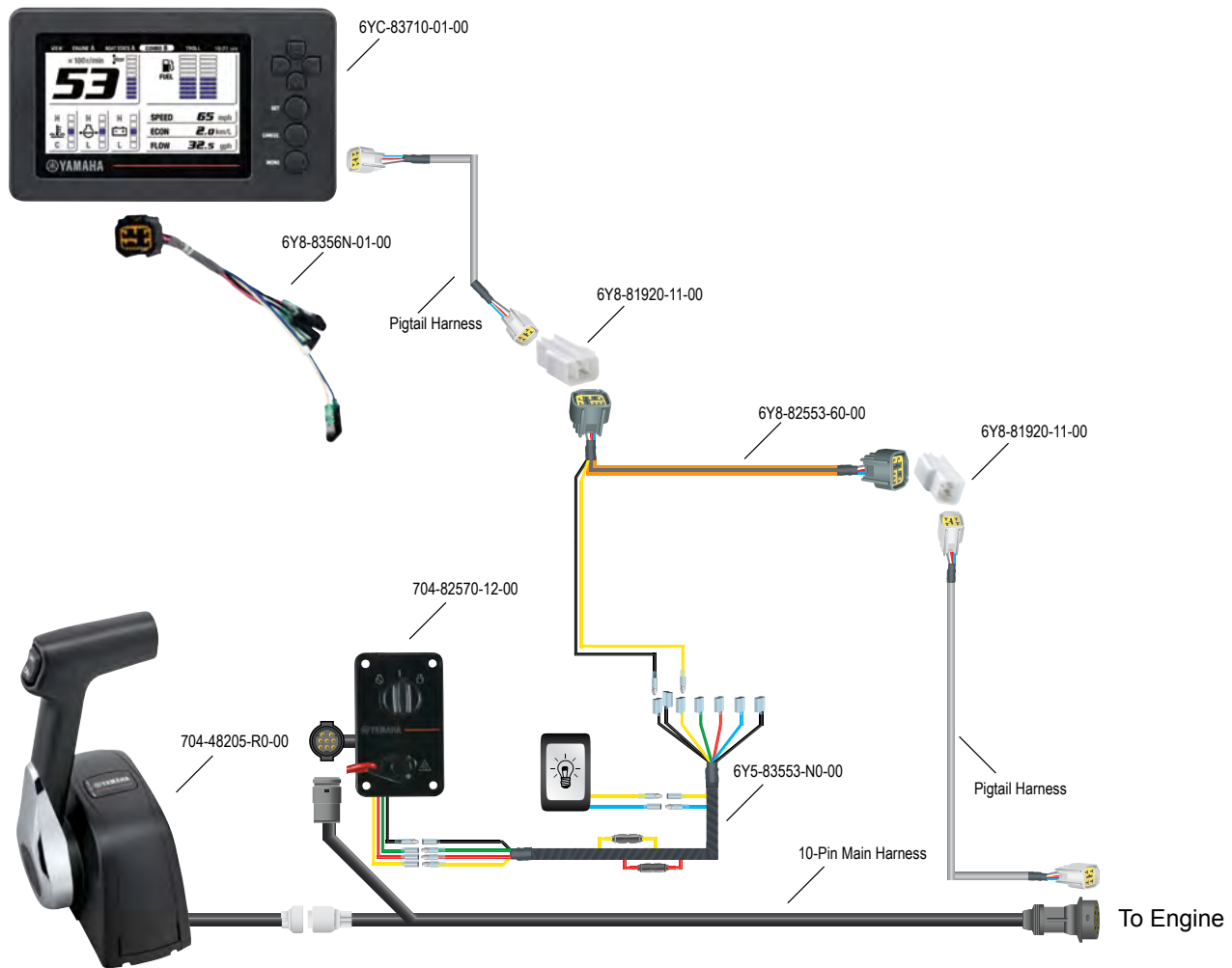

Parts order list for basic installation:

Quantity	Description	Part Number
1	Premium 704 Single Engine Binnacle Control Box	704-48205-R0-00
1	Single Engine Key Switch	704-82570-12-00
1	6YC Display	6YC-83710-01-00
1	Dual Fuse Harness	6Y5-83553-N0-00
1	Orange Extension Harness (14 ft.)	6Y8-82553-60-00
2	Single Hubs	6Y8-81920-11-00
1	GPS / Fuel Harness	6Y8-8356N-01-00
1	10-Pin Main Harness	See List ¹
1	Pig Tail Harness, Engine to Rear Hub	See List ²
1	Pig Tail Harness, Front Hub to Display	See List ²

¹ 10-Pin Harnesses

16 ft.	688-8258A-50-00
20 ft.	688-8258A-60-00
23 ft.	688-8258A-70-00
26 ft.	6K1-8258A-40-00
31.2 ft.	61B-8258A-01-00

² Pigtail Harnesses

1 ft.	6Y8-82521-01-00
2 ft.	6Y8-82521-11-00
3 ft.	6Y8-82521-21-00
6 ft.	6Y8-82521-31-00
9 ft.	6Y8-82521-41-00
12 ft.	6Y8-82521-51-00

Single Engine with Binnacle Controls - 6YC Display

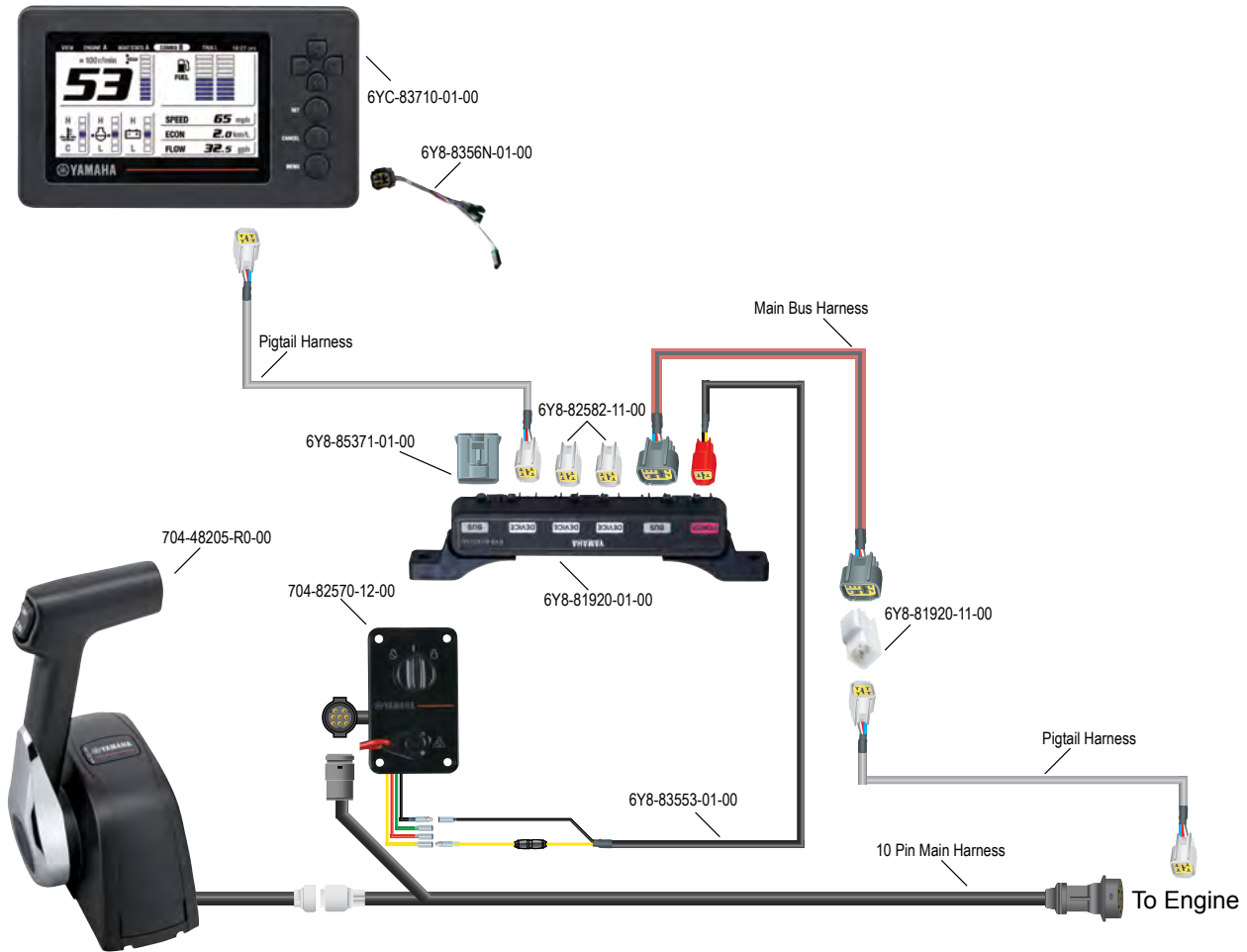

Parts order list for basic installation:

Quantity	Description	Part Number
1	Premium 704 Single Engine Binnacle Control Box	704-48205-R0-00
1	Single Engine Key Switch	704-82570-12-00
1	6YC Display Kit	6YC-0E83C-30-00
1	10-Pin Main Harness	See List ¹
1	Main Buss Harness, Rear Hub to Front Hub	See List ²
1	Pigtail Harnesses, Front Hub to Gauges	See List ³

¹ 10-Pin Harnesses

16 ft.	688-8258A-50-00
20 ft.	688-8258A-60-00
23 ft.	688-8258A-70-00
26 ft.	6K1-8258A-40-00
31.2 ft.	61B-8258A-01-00

² Main Bus Harnesses

1 ft.	6Y8-82553-01-00
10 ft.	6Y8-82553-50-00
15 ft.	6Y8-82553-11-00
20 ft.	6Y8-82553-21-00
25 ft.	6Y8-82553-31-00
30 ft.	6Y8-82553-41-00

³ Pigtail Harnesses

1 ft.	6Y8-82521-01-00
2 ft.	6Y8-82521-11-00
3 ft.	6Y8-82521-21-00
6 ft.	6Y8-82521-31-00
9 ft.	6Y8-82521-41-00
12 ft.	6Y8-82521-51-00

Single Engine with Binnacle Controls - 6YC Display

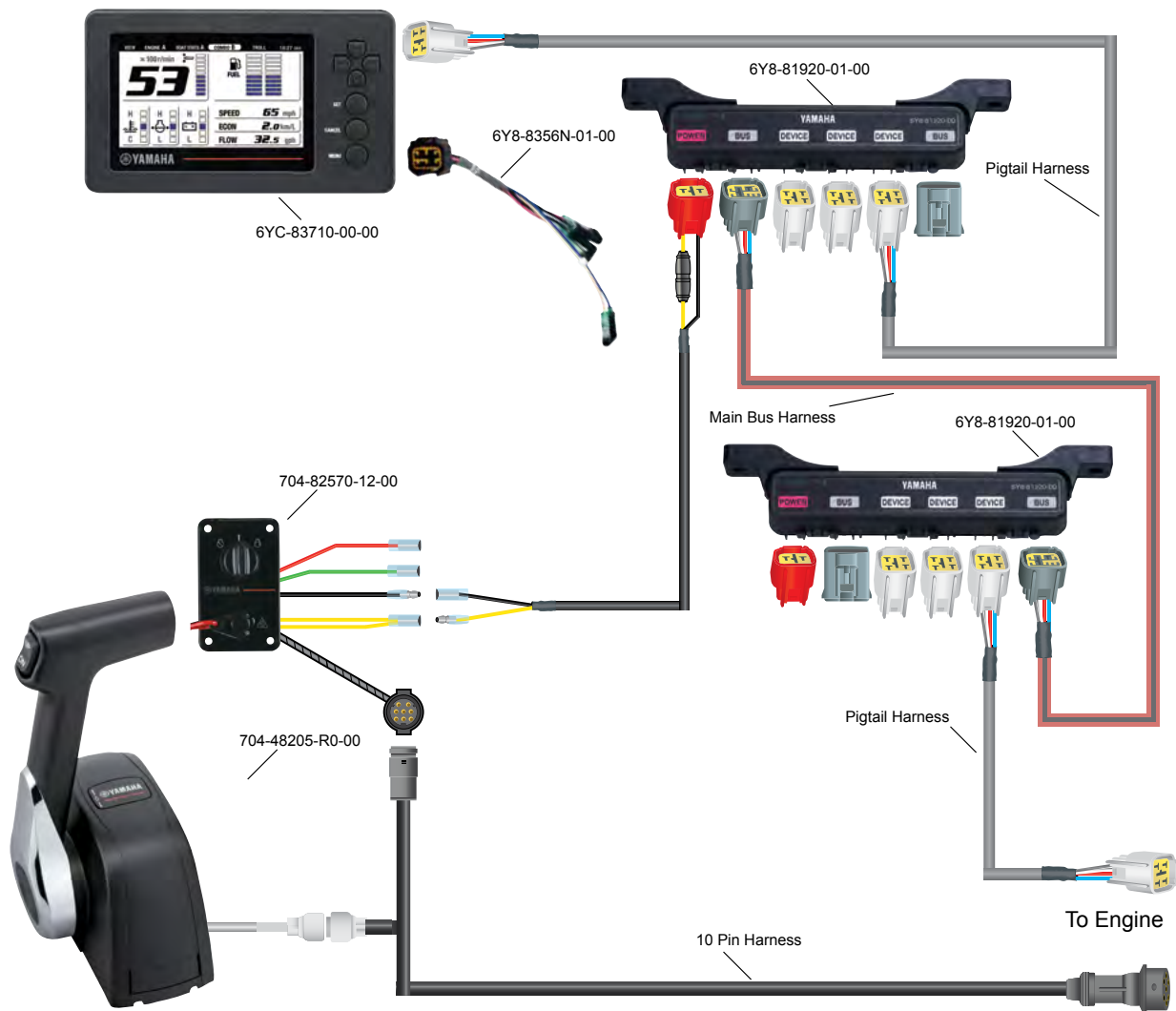

Parts order list for basic installation:

Quantity	Description	Part Number
1	6YC Display Kit with 704 Remote Control	6YC-0E83C-10-00
1	Main Buss Harness, Rear Hub to Front Hub	See List ¹
1	Pigtail Harnesses, Front Hub to Display	See List ²

¹ Main Bus Harnesses

1 ft.	6Y8-82553-01-00
10 ft.	6Y8-82553-50-00
15 ft.	6Y8-82553-11-00
20 ft.	6Y8-82553-21-00
25 ft.	6Y8-82553-31-00
30 ft.	6Y8-82553-41-00

² Pigtail Harnesses

1 ft.	6Y8-82521-01-00
2 ft.	6Y8-82521-11-00
3 ft.	6Y8-82521-21-00
6 ft.	6Y8-82521-31-00
9 ft.	6Y8-82521-41-00
12 ft.	6Y8-82521-51-00

General Information

Rigging Estimate Guide (Diagrams)

Rigging Components

Electrical Components

Engine Accessories

Propellers

Maintenance Items

Oils & Lubes

Detailing & Trailer Supplies

Accessories & Apparel

Generators & Accessories

Single Engine with DEC Flush Mount Controls - Command Link®

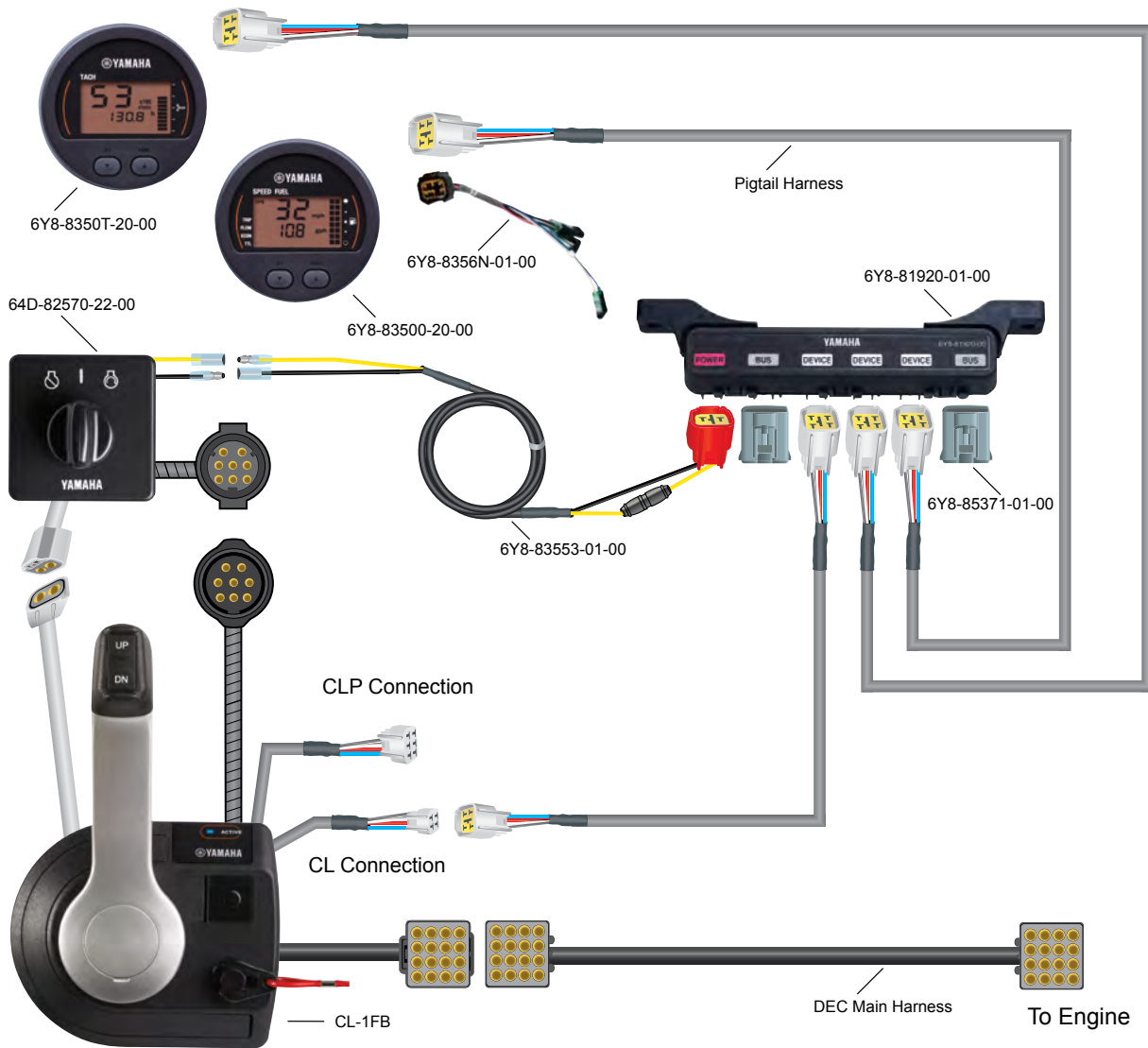

Parts order list for basic installation:

Quantity	Description	Part Number
1	Command Link Plus® Flush Mount Control	CL-1FB
1	Single Engine Key Switch	64D-82570-22-00
1	Command Link® Tachometer	6Y8-8350T-20-00
1	Command Link® Speed / Fuel Gauge	6Y8-83500-20-00
1	Multi-Hub Assembly	6Y8-81920-01-00
1	Power Lead, 8 ft.	6Y8-83553-01-00
1	Multi-Hub Resistor	6Y8-85371-01-00
1	Fuel Sender and GPSWire Lead	6Y8-8356N-01-00
1	DEC Main Harness	See List ¹
1	Pigtail Harness, Control box to hub	See List ²
2	Pigtail Harness, Hub to gauges	See List ²

¹ DEC Main Harnesses

20 ft.	6X6-8258A-00-00
23 ft.	6X6-8258A-10-00
26 ft.	6X6-8258A-20-00
33.5 ft.	6X6-8258A-30-00
39 ft.	6X6-8258A-40-00

² Pigtail Harnesses

1 ft.	6Y8-82521-01-00
2 ft.	6Y8-82521-11-00
3 ft.	6Y8-82521-21-00
6 ft.	6Y8-82521-31-00
9 ft.	6Y8-82521-41-00
12 ft.	6Y8-82521-51-00

Single Engine with DEC Binnacle Controls - Command Link®

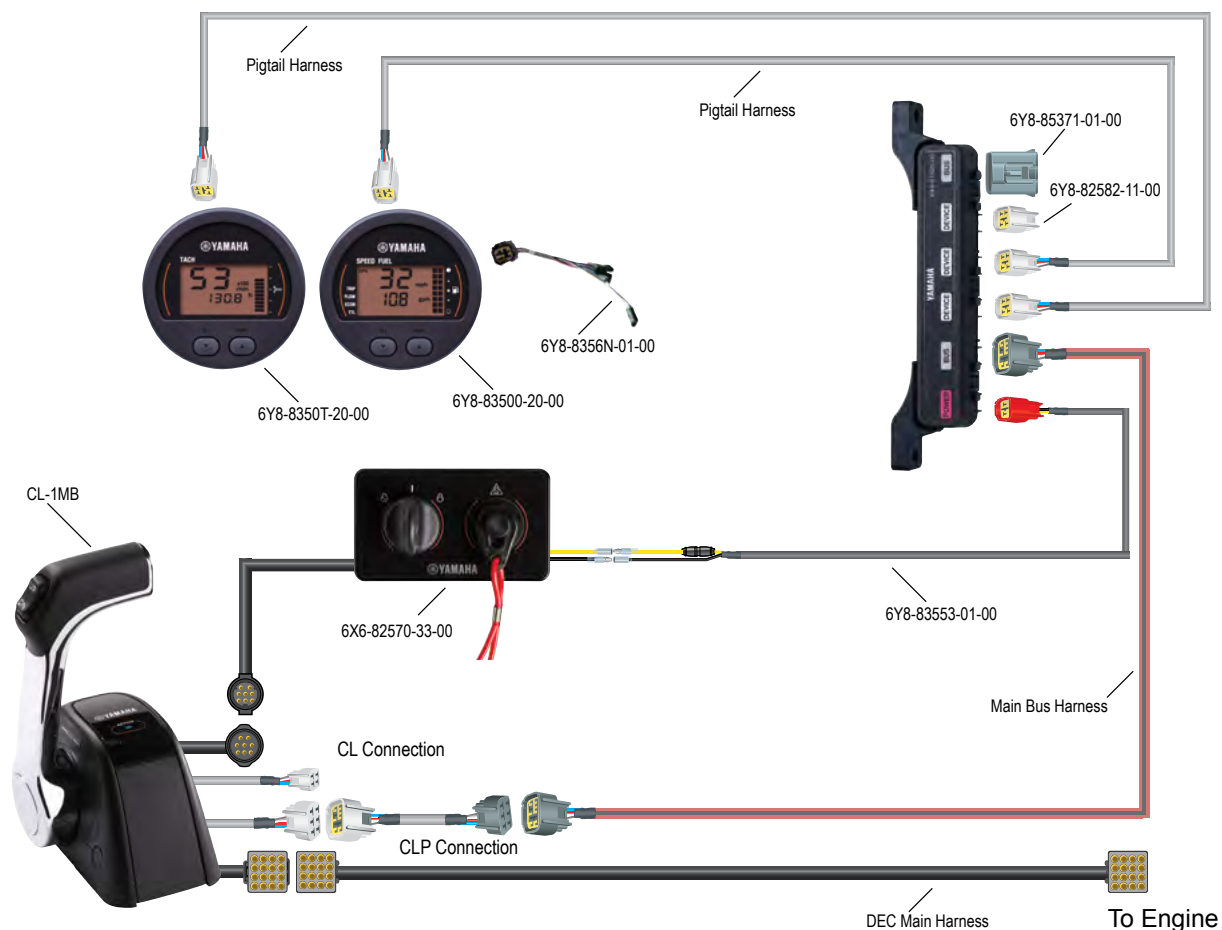

Parts order list for basic installation:

Quantity	Description	Part Number
1	Command Link Plus® Single Main Station Control	CL-1MB
1	Single Engine Key Switch	6X6-82570-33-00
1	DEC Single Engine Round Gauge Kit	6X6-0E83R-21-00
1	DEC Main Harness	See List ¹
2	Pigtail Harness, Hub to Gauges	See List ²

¹ DEC Main Harnesses

20 ft.	6X6-8258A-00-00
23 ft.	6X6-8258A-10-00
26 ft.	6X6-8258A-20-00
33.5 ft.	6X6-8258A-30-00
39 ft.	6X6-8258A-40-00

² Pigtail Harnesses

1 ft.	6Y8-82521-01-00
2 ft.	6Y8-82521-11-00
3 ft.	6Y8-82521-21-00
6 ft.	6Y8-82521-31-00
9 ft.	6Y8-82521-41-00
12 ft.	6Y8-82521-51-00

General Information

Rigging Estimate Guide (Diagrams)

Rigging Components

Electrical Components

Engine Accessories

Propellers

Maintenance Items

Oils & Lubes

Detailing & Trailer Supplies

Accessories & Apparel

Generators & Accessories

Single Engine with DEC Flush Mount Controls - 6YC Display

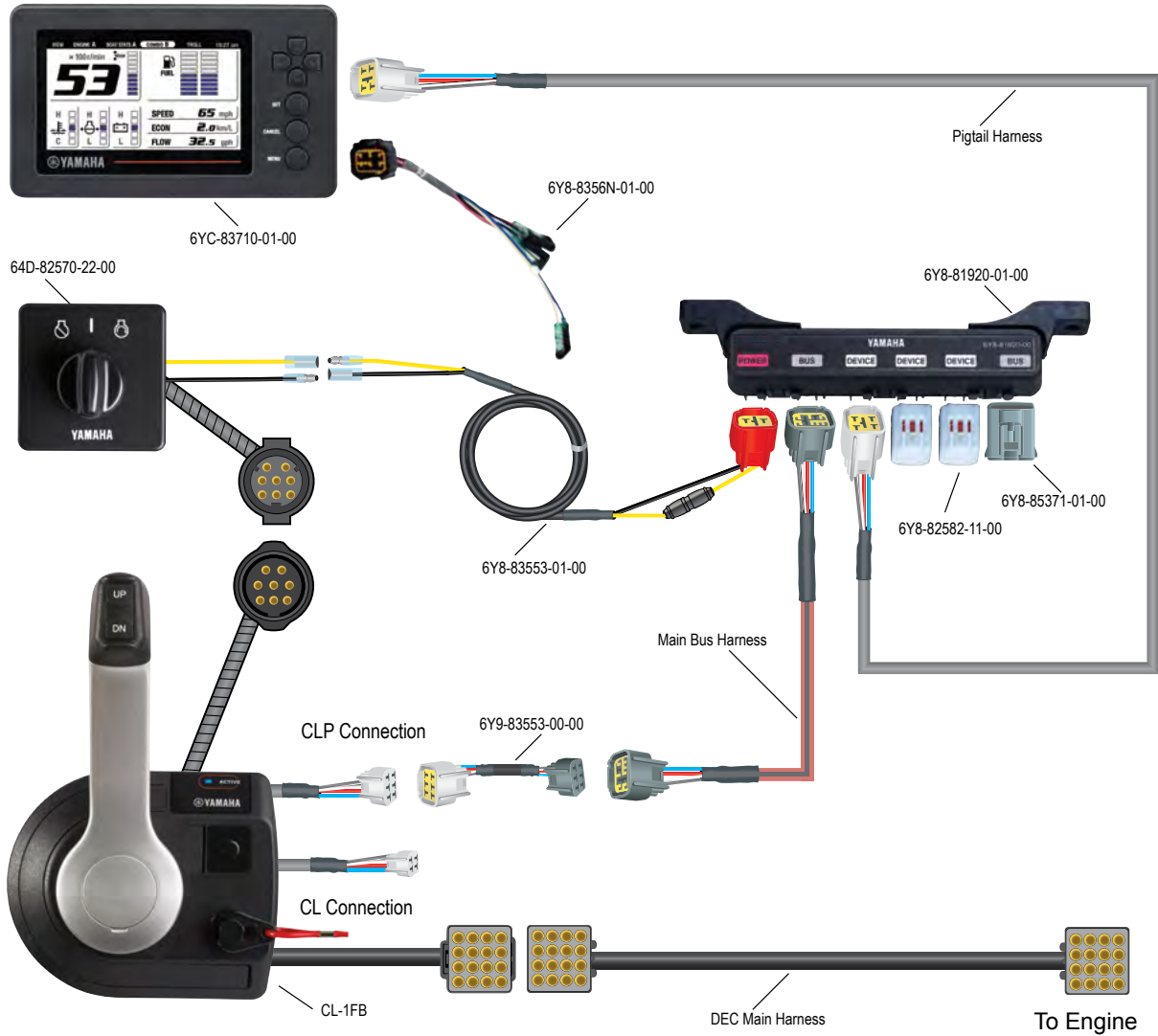

Parts order list for basic installation:

Quantity	Description	Part Number
1	Command Link Plus® Flush Mount Control	CL-1FB
1	Single Engine Key Switch	64D-82570-22-00
1	6YC Display Kit	6X6-0E83C-00-00
1	DEC Main Harness	See List ¹
1	Main Bus Harness, Control Box Adaptor to Hub	See List ²
1	Pigtail Harness, Hub to Display	See List ³

¹ DEC Main Harnesses

20 ft.	6X6-8258A-00-00
23 ft.	6X6-8258A-10-00
26 ft.	6X6-8258A-20-00
33.5 ft.	6X6-8258A-30-00
39 ft.	6X6-8258A-40-00

² Main Bus Harnesses

1 ft.	6Y8-82553-01-00
10 ft.	6Y8-82553-50-00
15 ft.	6Y8-82553-11-00
20 ft.	6Y8-82553-21-00
25 ft.	6Y8-82553-31-00
30 ft.	6Y8-82553-41-00

³ Pigtail Harnesses

1 ft.	6Y8-82521-01-00
2 ft.	6Y8-82521-11-00
3 ft.	6Y8-82521-21-00
6 ft.	6Y8-82521-31-00
9 ft.	6Y8-82521-41-00
12 ft.	6Y8-82521-51-00

Single Engine with DEC Binnacle Controls - 6YC Display

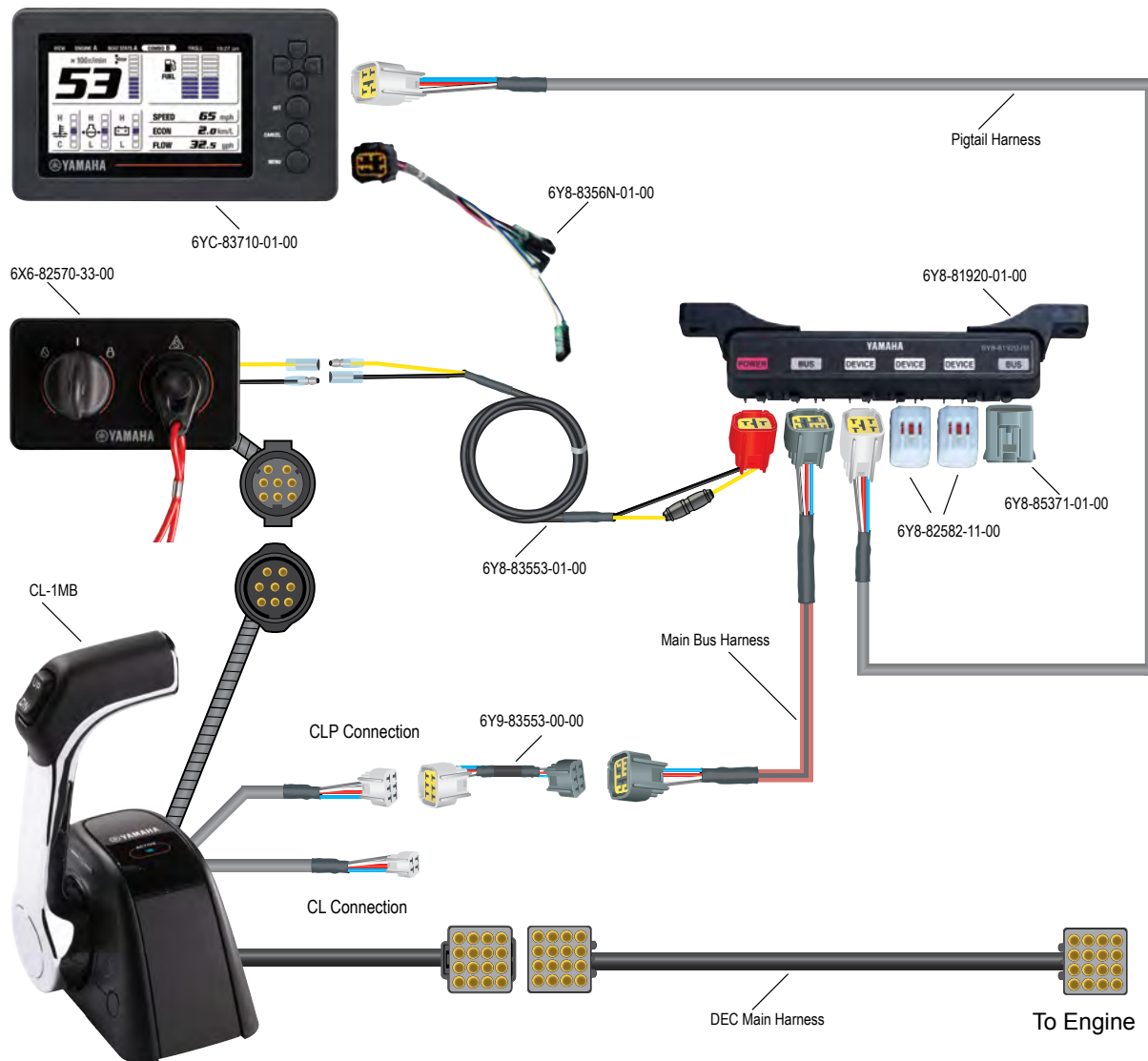

Parts order list for basic installation:

Quantity	Description	Part Number
1	Command Link Plus® Single Main Station Control	CL-1MB
1	Single Engine Key Switch	6X6-82570-33-00
1	6YC Display Kit	6X6-0E83C-00-00
1	DEC Main Harness	See List ¹
1	Main Bus Harness, Control Box Adaptor to Hub	See List ²
1	Pigtail Harness, Hub to Display	See List ³

² Main Bus Harnesses

1 ft.	6Y8-82553-01-00
10 ft.	6Y8-82553-50-00
15 ft.	6Y8-82553-11-00
20 ft.	6Y8-82553-21-00
25 ft.	6Y8-82553-31-00
30 ft.	6Y8-82553-41-00

¹ DEC Main Harnesses

20 ft.	6X6-8258A-00-00
23 ft.	6X6-8258A-10-00
26 ft.	6X6-8258A-20-00
33.5 ft.	6X6-8258A-30-00
39 ft.	6X6-8258A-40-00

³ Pigtail Harnesses

1 ft.	6Y8-82521-01-00
2 ft.	6Y8-82521-11-00
3 ft.	6Y8-82521-21-00
6 ft.	6Y8-82521-31-00
9 ft.	6Y8-82521-41-00
12 ft.	6Y8-82521-51-00

Single Engine with CL7 Display & DEC Binnacle Mount Controls Command Link Plus®

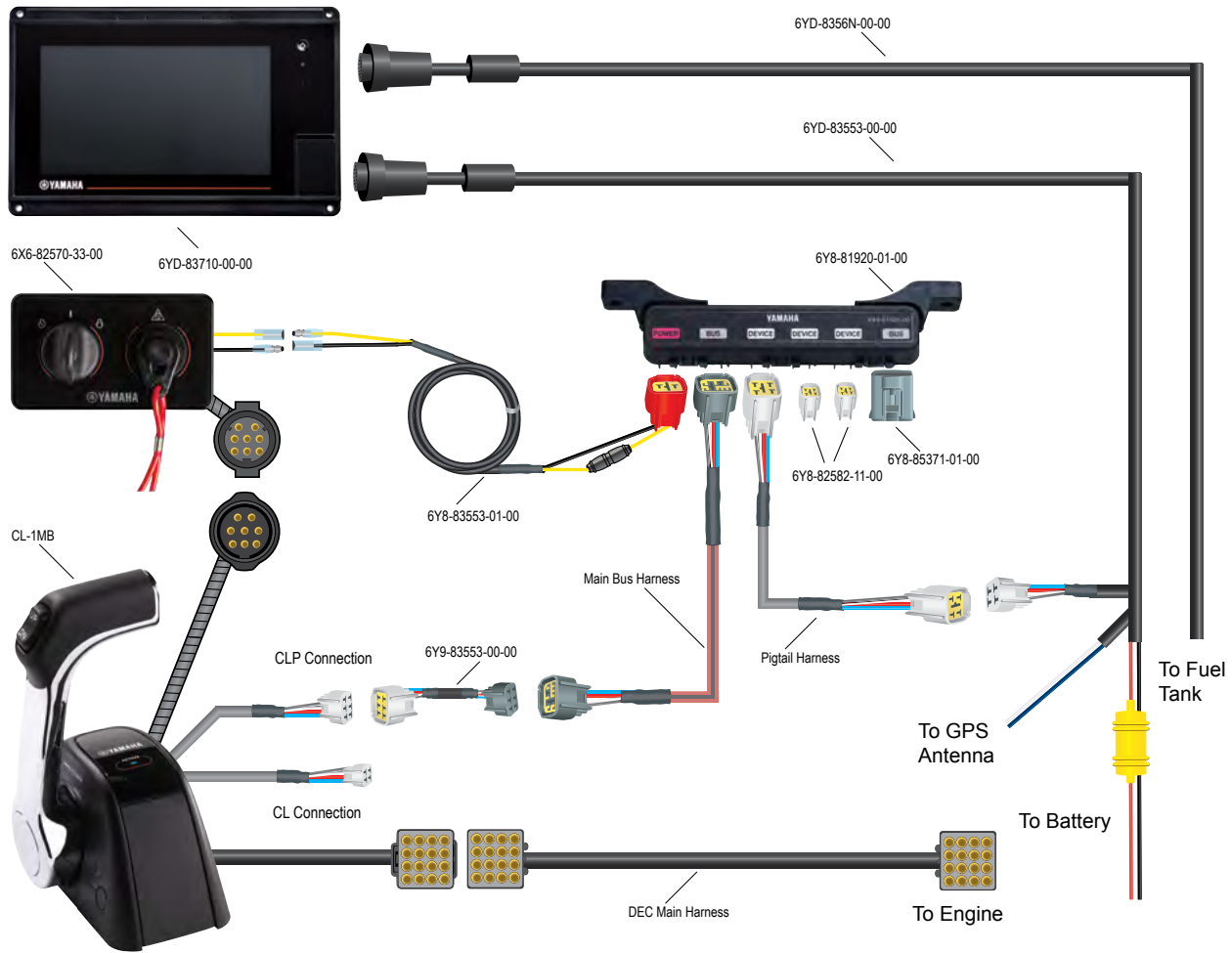

Parts order list for basic installation:

Quantity	Description	Part Number
1	Command Link Plus® Single Main Station Control	CL-1MB
1	Single Engine Key Switch	64D-82570-22-00
1	CL7 - Command Link Plus® Display Kit	MAR-CL7DU-KT-00
1	CL7 - Command Link Plus® Display Installation Kit	MAR-CL7DI-KT-20
1	DEC Main Harness	See List ¹
1	Main Bus Harness, Control Box Adaptor to Hub	See List ²
1	Pigtail Harness, Hub to Display Harness	See List ³

¹ DEC Main Harnesses

20 ft.	6X6-8258A-00-00
23 ft.	6X6-8258A-10-00
26 ft.	6X6-8258A-20-00
33.5 ft.	6X6-8258A-30-00
39 ft.	6X6-8258A-40-00

² Main Bus Harnesses

1 ft.	6Y8-82553-01-00
10 ft.	6Y8-82553-50-00
15 ft.	6Y8-82553-11-00
20 ft.	6Y8-82553-21-00
25 ft.	6Y8-82553-31-00
30 ft.	6Y8-82553-41-00

³ Pigtail Harnesses

1 ft.	6Y8-82521-01-00
2 ft.	6Y8-82521-11-00
3 ft.	6Y8-82521-21-00
6 ft.	6Y8-82521-31-00
9 ft.	6Y8-82521-41-00
12 ft.	6Y8-82521-51-00

Single Engine with CL7 Display & DEC Flush Mount Controls Command Link Plus®



Parts order list for basic installation:

Quantity	Description	Part Number
1	Command Link Plus® Flush Mount Control	CL-1FB
1	Single Engine Key Switch	64D-82570-22-00
1	CL7 - Command Link Plus® Display Kit	MAR-CL7DU-KT-00
1	CL7 - Command Link Plus® Display Installation Kit	MAR-CL7DI-KT-20
1	DEC Main Harness	See List ¹
1	Main Bus Harness, Control Box Adaptor to Hub	See List ²
1	Pigtail Harness, Hub to Display Harness	See List ³

¹ DEC Main Harnesses

20 ft.	6X6-8258A-00-00
23 ft.	6X6-8258A-10-00
26 ft.	6X6-8258A-20-00
33.5 ft.	6X6-8258A-30-00
39 ft.	6X6-8258A-40-00

² Main Bus Harnesses

1 ft.	6Y8-82553-01-00
10 ft.	6Y8-82553-50-00
15 ft.	6Y8-82553-11-00
20 ft.	6Y8-82553-21-00
25 ft.	6Y8-82553-31-00
30 ft.	6Y8-82553-41-00

³ Pigtail Harnesses

1 ft.	6Y8-82521-01-00
2 ft.	6Y8-82521-11-00
3 ft.	6Y8-82521-21-00
6 ft.	6Y8-82521-31-00
9 ft.	6Y8-82521-41-00
12 ft.	6Y8-82521-51-00

Single Engine with DEC Binnacle Controls -2nd Station

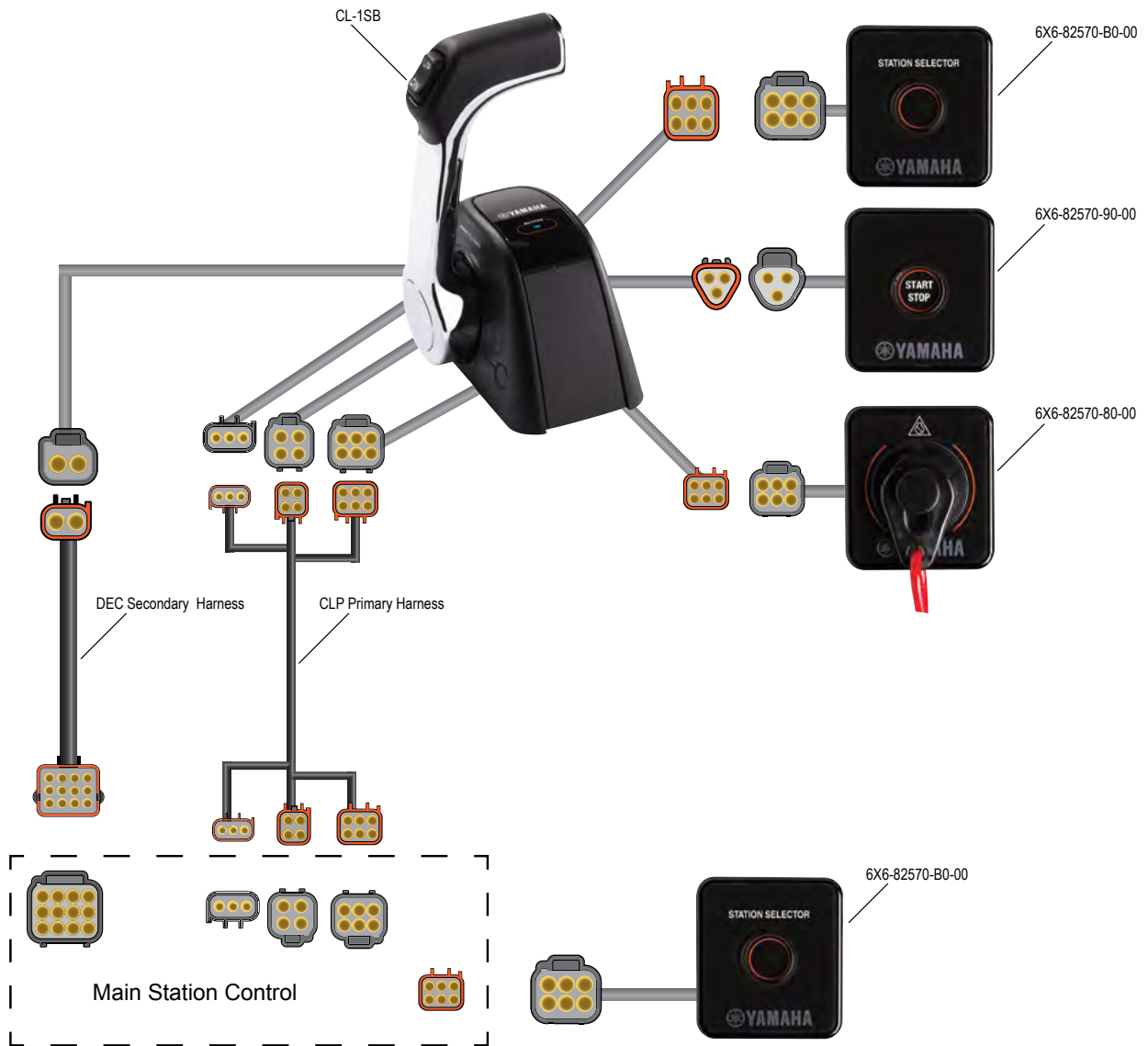

Parts order list for basic installation:

Quantity	Description	Part Number
1	Command Link Plus® 2 nd Station Single Engine Control Box	CL-1SB
1	Command Link Plus® 2 nd Station Switch Set	6X6-W0035-70-00
1	CLP Primary Harness	See List ¹
1	DEC Secondary Harness	See List ²

¹ CLP Primary Harness	16 ft.	6X6-8258A-G1-00
	26 ft.	6X6-8258A-H1-00
	40 ft.	6X6-8258A-J1-00
² DEC Secondary Harness	16 ft.	6X6-8258A-B1-00
	26 ft.	6X6-8258A-D1-00
	40 ft.	6X6-8258A-F1-00

Twin Engines with Mechanical Binnacle Controls - Multifunction Gauges

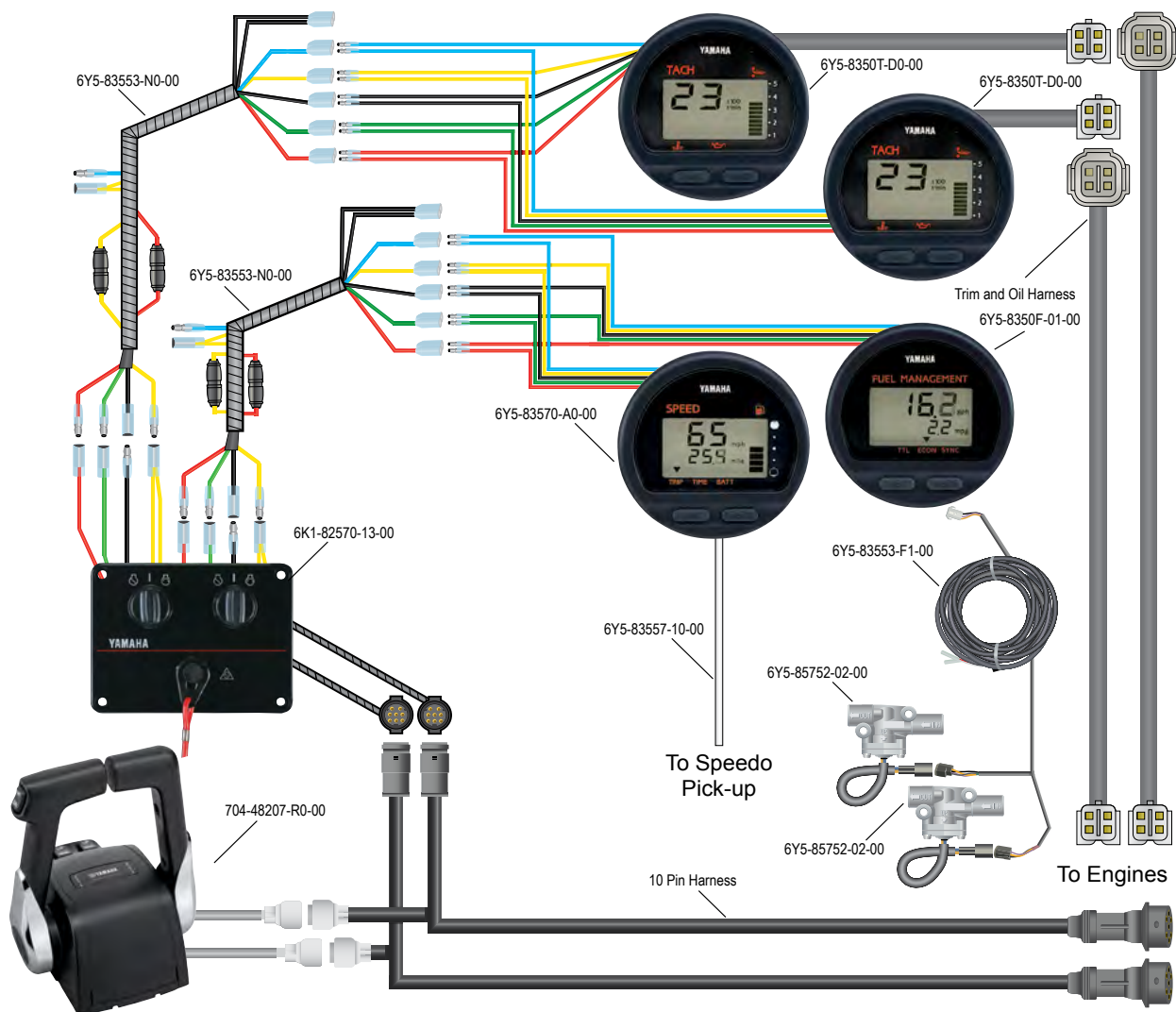

Parts order list for basic installation:

Quantity	Description	Part Number
1	Twin Engine 704 Control Box	704-48207-R0-00
1	Twin Engine Key Switch Panel	6K1-82570-13-00
2	Multifunction Tachometer	6Y5-8350T-D0-00
1	Multifunction Speedometer	6Y5-83570-A0-00
1	Multifunction Fuel Meter Kit	6Y5-W0088-55-00
2	Fuel Flow Sensor (extra for twins)	6Y5-85752-02-00
1	Speedometer Tube, 8.0 m	6Y5-83557-10-00
2	Dual Fuse Harness	6Y5-83553-N0-00
2	Clamp	90465-10098-00
10	Clamp	90465-13M39-00
2	10 Pin Main Harness	See List ¹
2	Trim and Oil Harness (2005~)	See List ²

¹ 10-Pin Harnesses

16 ft.	688-8258A-50-00
20 ft.	688-8258A-60-00
23 ft.	688-8258A-70-00
26 ft.	6K1-8258A-40-00
31.2 ft.	61B-8258A-01-00

² 2005~ Trim and Oil Harness

16.4 ft.	6Y5-83653-00-00
19.7 ft.	6Y5-83653-10-00
23 ft.	6Y5-83653-20-00
26.3 ft.	6Y5-83653-30-00
30 ft.	6Y5-83653-40-00
35 ft.	6Y5-83653-50-00

Twin Engines with Mechanical Binnacle Controls - Command Link®

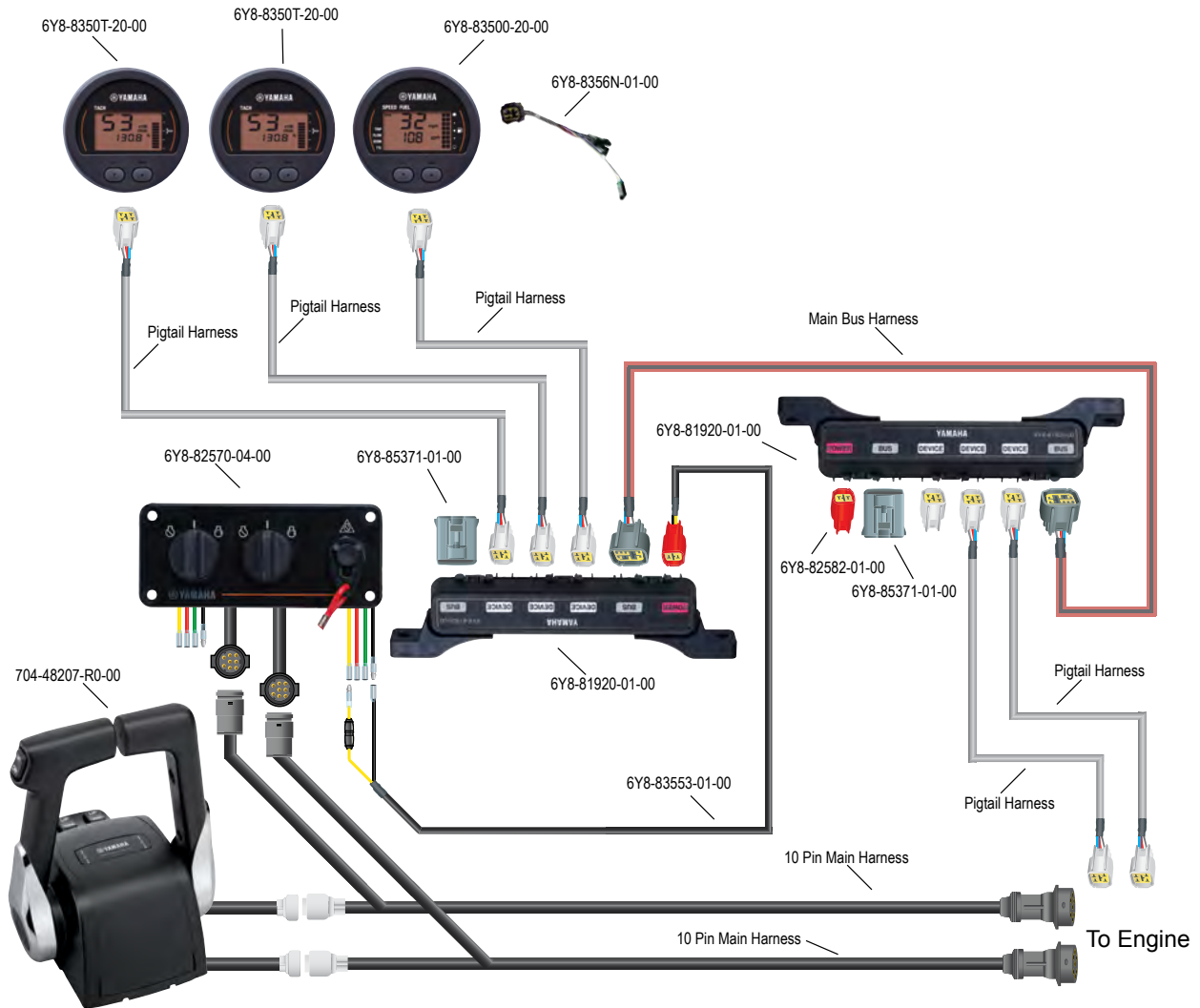

Parts order list for basic installation:

Quantity	Description	Part Number
1	Command Link® Twin Engine Three Gauge Kit w/ 704 Control	6Y8-0E83R-51-00
1	Main Bus Harness, Rear Hub to Front Hub	See List ¹
3	Pigtail Harness, Front Hub to Gauges	See List ²

¹ Main Bus Harnesses

1 ft.	6Y8-82553-01-00
10 ft.	6Y8-82553-50-00
15 ft.	6Y8-82553-11-00
20 ft.	6Y8-82553-21-00
25 ft.	6Y8-82553-31-00
30 ft.	6Y8-82553-41-00

² Pigtail Harnesses

1 ft.	6Y8-82521-01-00
2 ft.	6Y8-82521-11-00
3 ft.	6Y8-82521-21-00
6 ft.	6Y8-82521-31-00
9 ft.	6Y8-82521-41-00
12 ft.	6Y8-82521-51-00

Twin Engines with Mechanical Binnacle Controls - 6YC Display

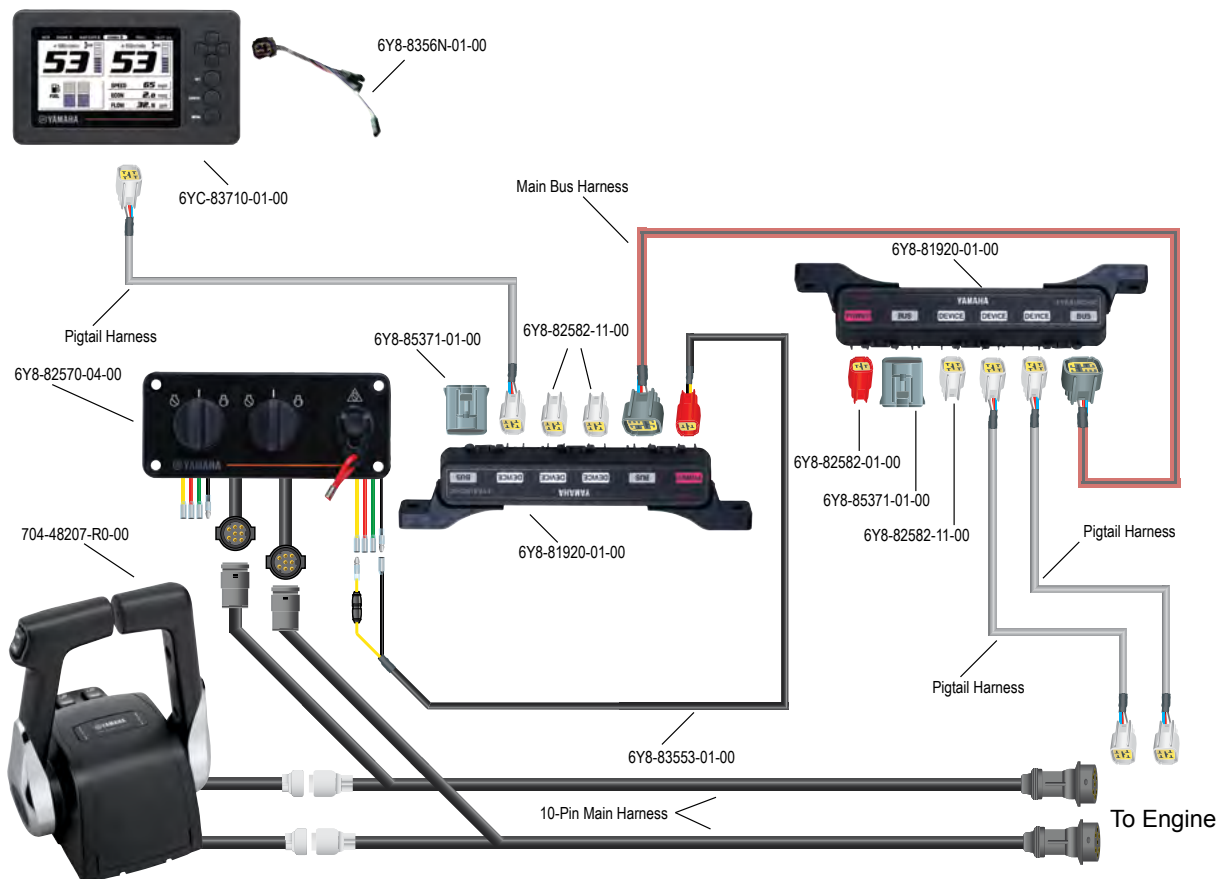

Parts order list for basic installation:

Quantity	Description	Part Number
1	6YC Display Kit with 704 Remote Control	6YC-0E83C-20-00
1	Main Buss Harness, Rear Hub to Front Hub	See List ¹
1	Pigtail Harnesses, Front Hub to Gauges	See List ²

¹ Main Bus Harnesses

1 ft.	6Y8-82553-01-00
10 ft.	6Y8-82553-50-00
15 ft.	6Y8-82553-11-00
20 ft.	6Y8-82553-21-00
25 ft.	6Y8-82553-31-00
30 ft.	6Y8-82553-41-00

² Pigtail Harnesses

1 ft.	6Y8-82521-01-00
2 ft.	6Y8-82521-11-00
3 ft.	6Y8-82521-21-00
6 ft.	6Y8-82521-31-00
9 ft.	6Y8-82521-41-00
12 ft.	6Y8-82521-51-00

Twin Engines with DEC Controls - Command Link®

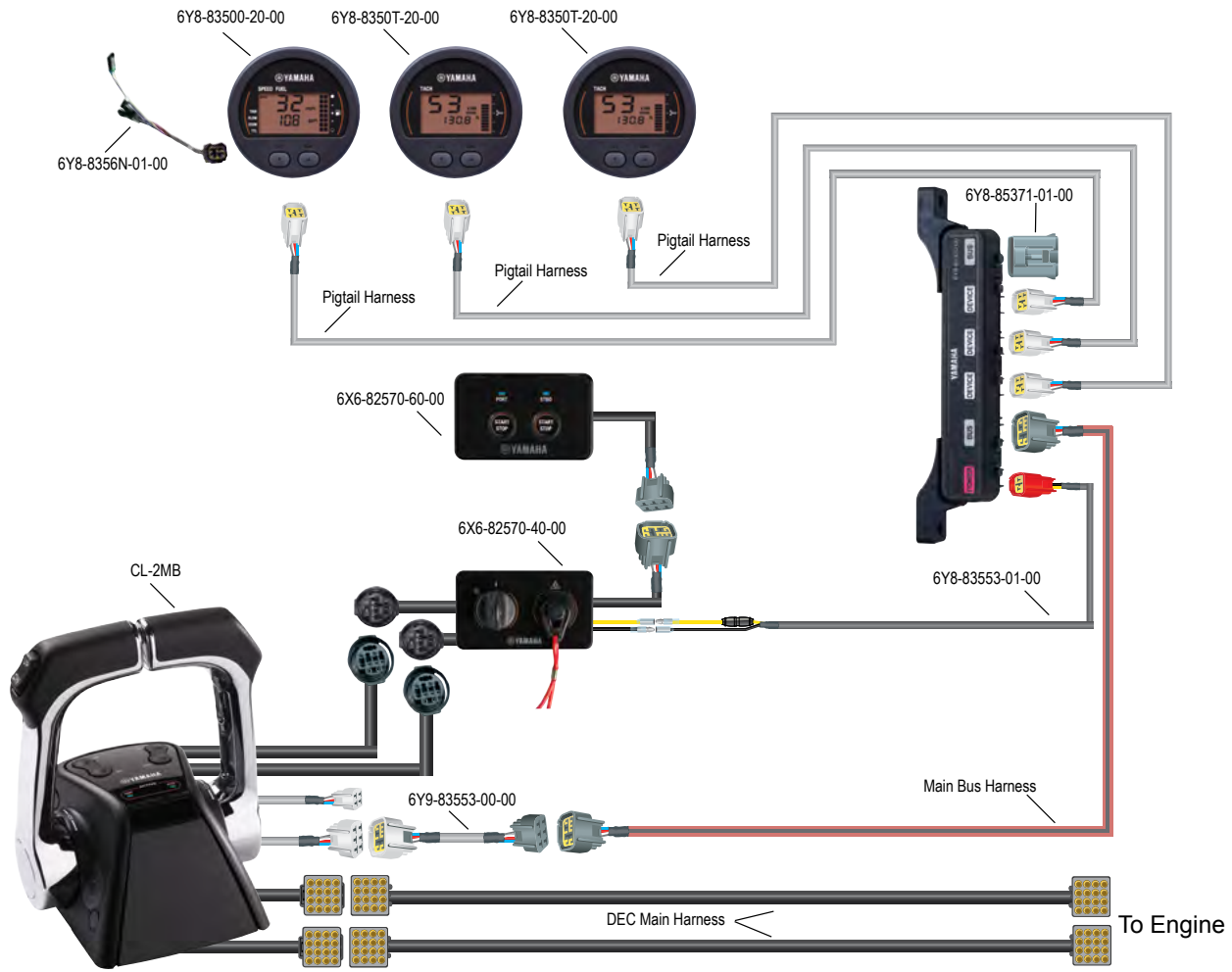

Parts order list for basic installation:

Quantity	Description	Part Number
1	Command Link Plus® Twin Main Station Control	CL-2MB
1	Twin Engines Key Switch Kit	6X6-W0035-50-00
1	Command Link® DEC Twin Main Station Gauge Kit	6X6-0E83R-31-00
2	DEC Main Harness	See List ¹
3	Pigtail Harness, Hub to Gauges	See List ²

¹ DEC Main Harnesses

- 20 ft. 6X6-8258A-00-00
- 23 ft. 6X6-8258A-10-00
- 26 ft. 6X6-8258A-20-00
- 33.5 ft. 6X6-8258A-30-00
- 39 ft. 6X6-8258A-40-00

² Pigtail Harnesses

- 1 ft. 6Y8-82521-01-00
- 2 ft. 6Y8-82521-11-00
- 3 ft. 6Y8-82521-21-00
- 6 ft. 6Y8-82521-31-00
- 9 ft. 6Y8-82521-41-00
- 12 ft. 6Y8-82521-51-00

Twin Engines with DEC Controls - 6YC Display

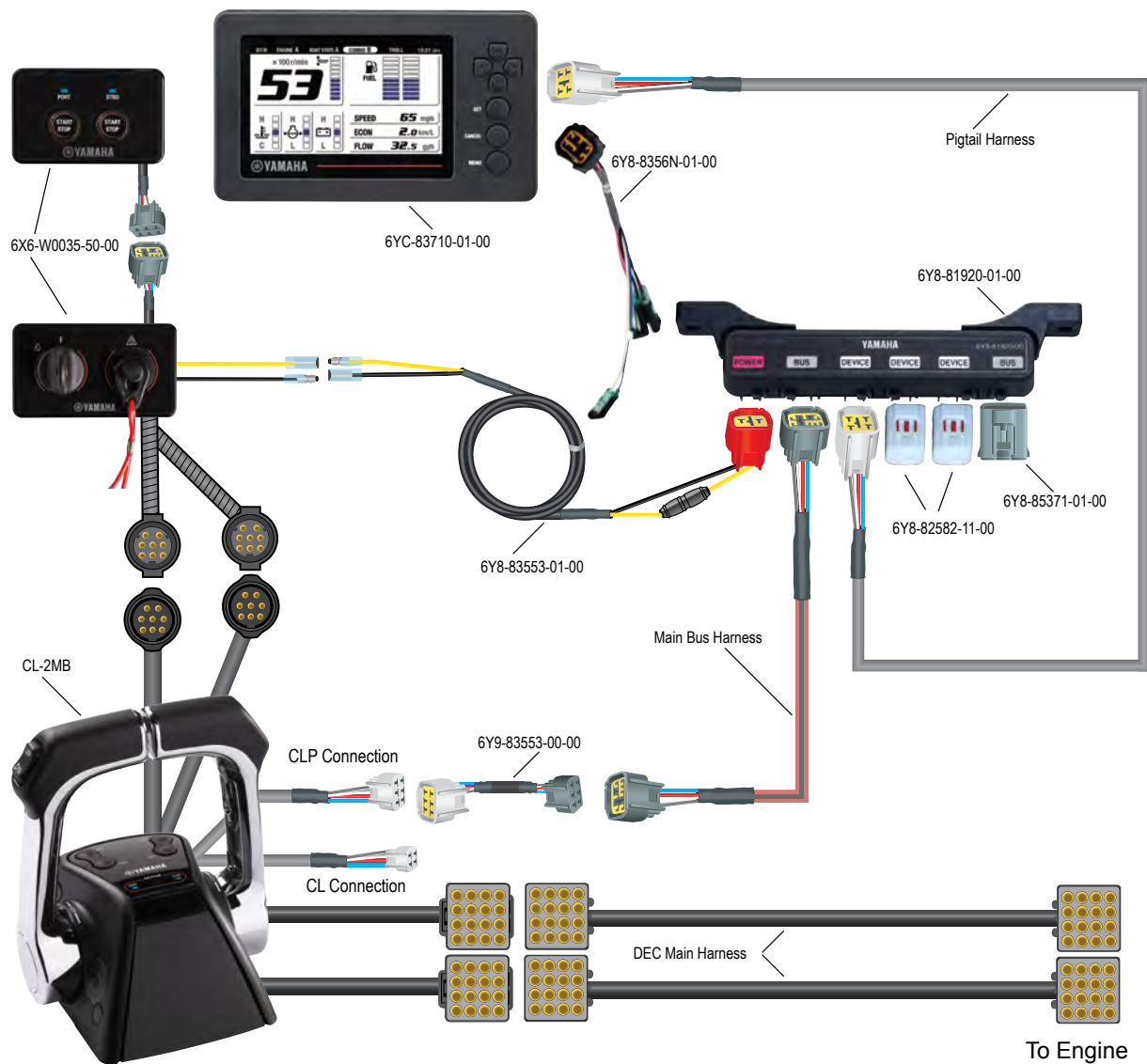

Parts order list for basic installation:

Quantity	Description	Part Number
1	Command Link Plus® Single Main Station Control	CL-2MB
1	Twin Engine Main Station Switch Kit	6X6-W0035-50-00
1	6YC Display Kit	6X6-0E83C-00-00
2	DEC Main Harness	See List ¹
1	Main Bus Harness, Control Box Adaptor to Hub	See List ²
1	Pigtail Harness, Hub to Display	See List ³

¹ DEC Main Harnesses	
20 ft.	6X6-8258A-00-00
23 ft.	6X6-8258A-10-00
26 ft.	6X6-8258A-20-00
33.5 ft.	6X6-8258A-30-00
39 ft.	6X6-8258A-40-00

² Main Bus Harnesses	
1 ft.	6Y8-82553-01-00
10 ft.	6Y8-82553-50-00
15 ft.	6Y8-82553-11-00
20 ft.	6Y8-82553-21-00
25 ft.	6Y8-82553-31-00
30 ft.	6Y8-82553-41-00

³ Pigtail Harnesses	
1 ft.	6Y8-82521-01-00
2 ft.	6Y8-82521-11-00
3 ft.	6Y8-82521-21-00
6 ft.	6Y8-82521-31-00
9 ft.	6Y8-82521-41-00
12 ft.	6Y8-82521-51-00

Twin Engine with CL7 Display & DEC Binnacle Mount Controls Command Link Plus®

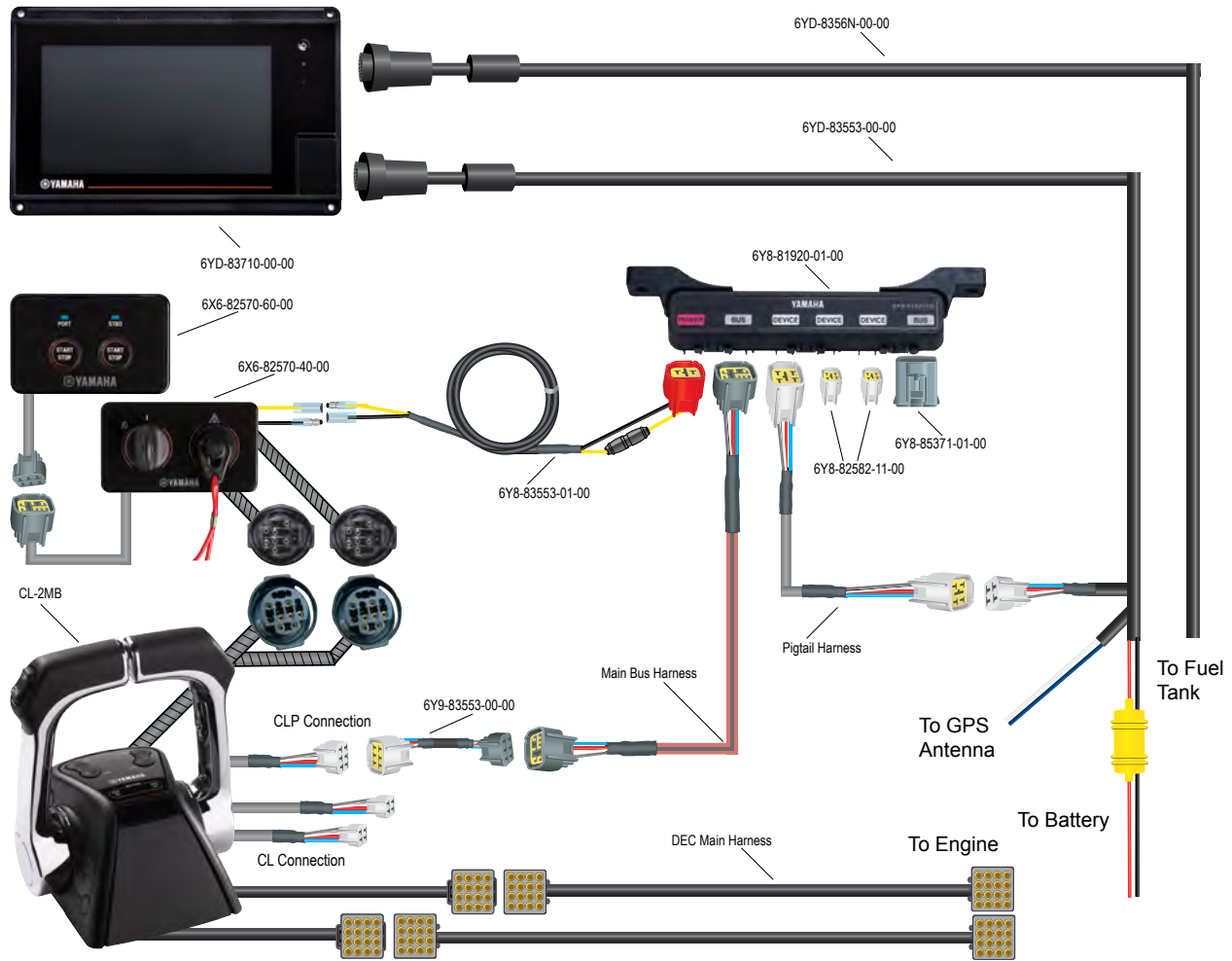

Parts order list for basic installation:

Quantity	Description	Part Number
1	Command Link Plus® Twin Main Station Control	CL-2MB
1	Twin Engine Key Switch Kit	6X6-W0035-50-00
1	CL7 - Command Link Plus® Display Kit	MAR-CL7DU-KT-00
1	CL7 - Command Link Plus® Display Installation Kit	MAR-CL7DI-KT-20
1	DEC Main Harness	See List ¹
1	Main Bus Harness, Control Box Adaptor to Hub	See List ²
1	Pigtail Harness, Hub to Display Harness	See List ³

¹ DEC Main Harnesses

20 ft.	6X6-8258A-00-00
23 ft.	6X6-8258A-10-00
26 ft.	6X6-8258A-20-00
33.5 ft.	6X6-8258A-30-00
39 ft.	6X6-8258A-40-00

² Main Bus Harnesses

1 ft.	6Y8-82553-01-00
10 ft.	6Y8-82553-50-00
15 ft.	6Y8-82553-11-00
20 ft.	6Y8-82553-21-00
25 ft.	6Y8-82553-31-00
30 ft.	6Y8-82553-41-00

³ Pigtail Harnesses

1 ft.	6Y8-82521-01-00
2 ft.	6Y8-82521-11-00
3 ft.	6Y8-82521-21-00
6 ft.	6Y8-82521-31-00
9 ft.	6Y8-82521-41-00
12 ft.	6Y8-82521-51-00

Twin Engines with DEC Controls - 2nd Station

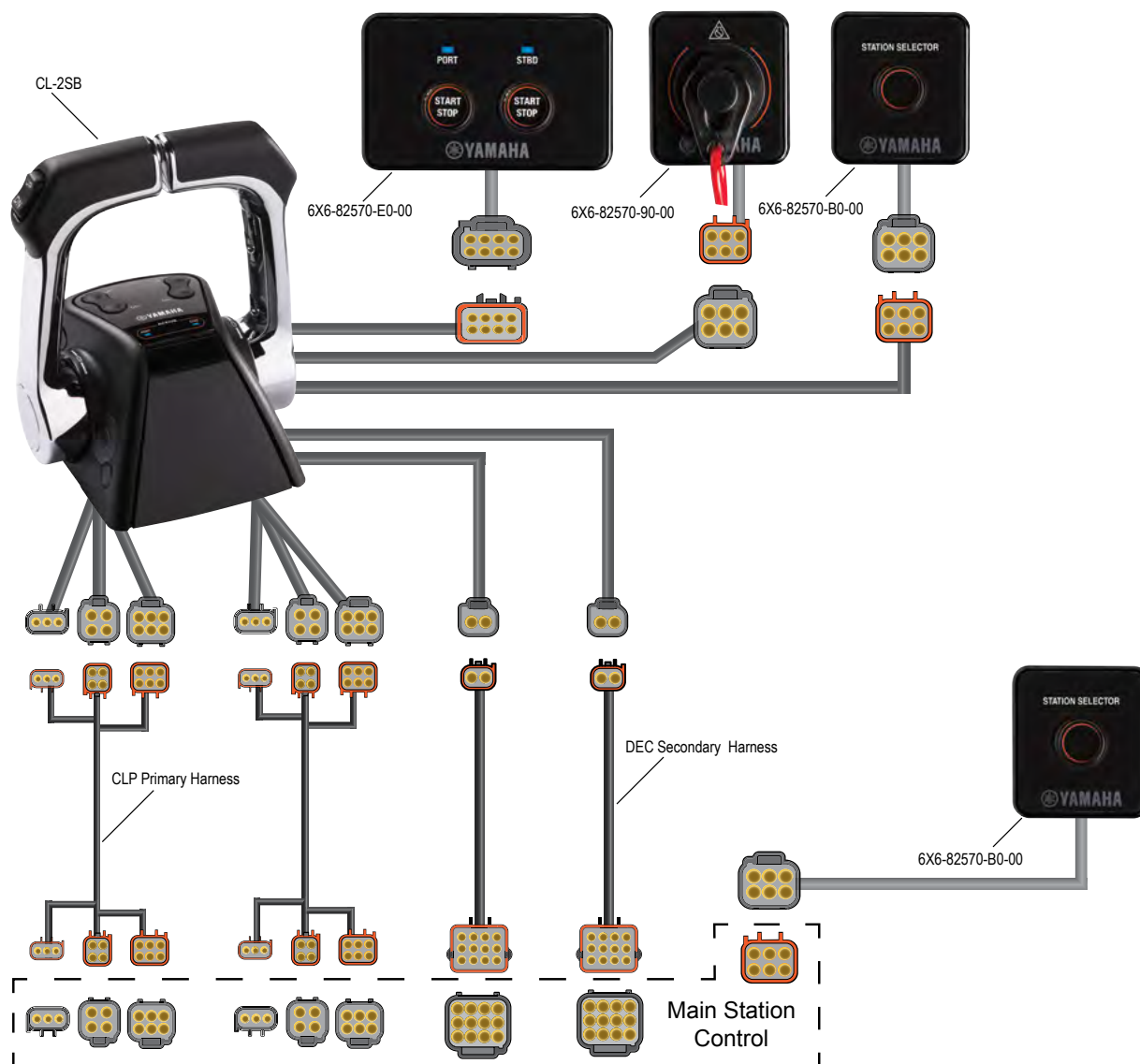

Parts order list for basic installation:

Quantity	Description	Part Number
1	Command Link Plus® 2 nd Station Twin Engine Control Box	CL-2SB
1	Command Link Plus® 2 nd Station Switch Set	6X6-W0035-80-00
2	CLP Primary Harness	See List ¹
2	DEC Secondary Harness	See List ²

¹ CLP Primary Harness

16 ft.	6X6-8258A-G1-00
26 ft.	6X6-8258A-H1-00
40 ft.	6X6-8258A-J1-00

² DEC Secondary Harness

16 ft.	6X6-8258A-B1-00
26 ft.	6X6-8258A-D1-00
40 ft.	6X6-8258A-F1-00

Triple Engines with Mechanical Binnacle Controls - Command Link®

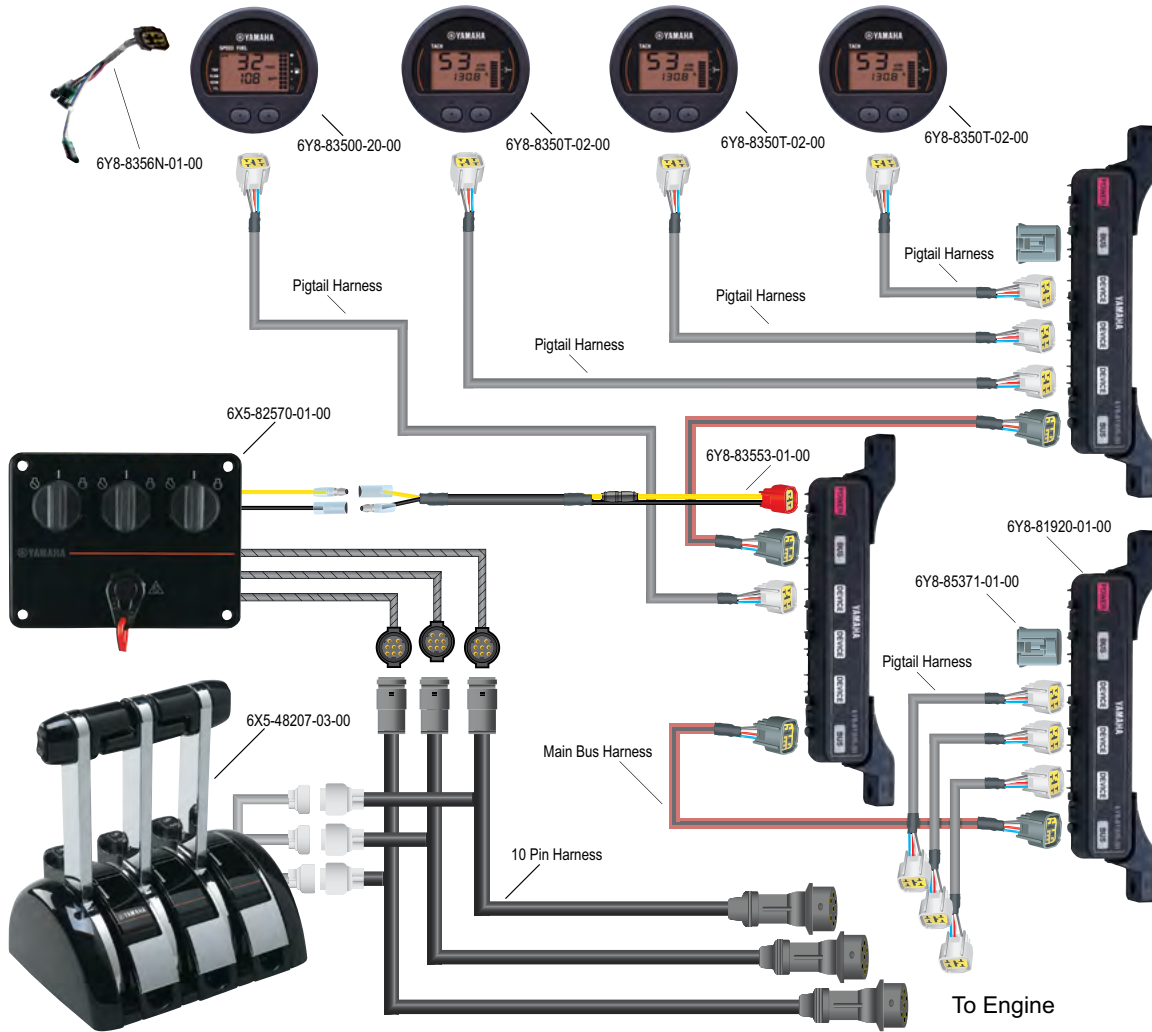

Parts order list for basic installation:

Quantity	Description	Part Number
3	Command Link® Round Tachometer	6Y8-8350T-02-00
1	Command Link® Round Speedometer/ Fuel Man.	6Y8-83500-20-00
3	Multi-Hub Assembly	6Y8-81920-01-00
1	Power Lead, 8 ft.	6Y8-83553-01-00
2	Cap, 2 Pin	6Y8-82582-01-00
2	Cap, 4 Pin	6Y8-82582-11-00
1	Speed Sensor Kit	60V-8A4L1-18-00
1	Triple Engine Main Switch Panel Assembly	6X5-48207-03-00
1	Fuel Sender and GPSWire Lead	6Y8-8356N-01-00
1	Main Wire Harness, 10 Pin, 26.2 ft.	6K1-8258A-40-00
2	Main Wire Harness, 10 Pin, 31.2 ft.	61B-8258A-01-00
3	Pigtail Harness, Engine to Rear Hub, 12 ft.	6Y8-82521-51-00
1	Main Bus Harness, 2nd to 3rd hub, 1 ft.	6Y8-82553-01-00
1	Triple Engine Binnacle Control Box	6X5-48207-03-00
1	Main Bus Harness, Rear Hub to Front Hub	See List ¹
4	Pigtail Harness, Front Hub to Gauges	See List ²

¹ Main Bus Harnesses

1 ft.	6Y8-82553-01-00
10 ft.	6Y8-82553-50-00
15 ft.	6Y8-82553-11-00
20 ft.	6Y8-82553-21-00
25 ft.	6Y8-82553-31-00
30 ft.	6Y8-82553-41-00

² Pigtail Harnesses

1 ft.	6Y8-82521-01-00
2 ft.	6Y8-82521-11-00
3 ft.	6Y8-82521-21-00
6 ft.	6Y8-82521-31-00
9 ft.	6Y8-82521-41-00
12 ft.	6Y8-82521-51-00

Triple Engines with DEC Controls - Command Link®

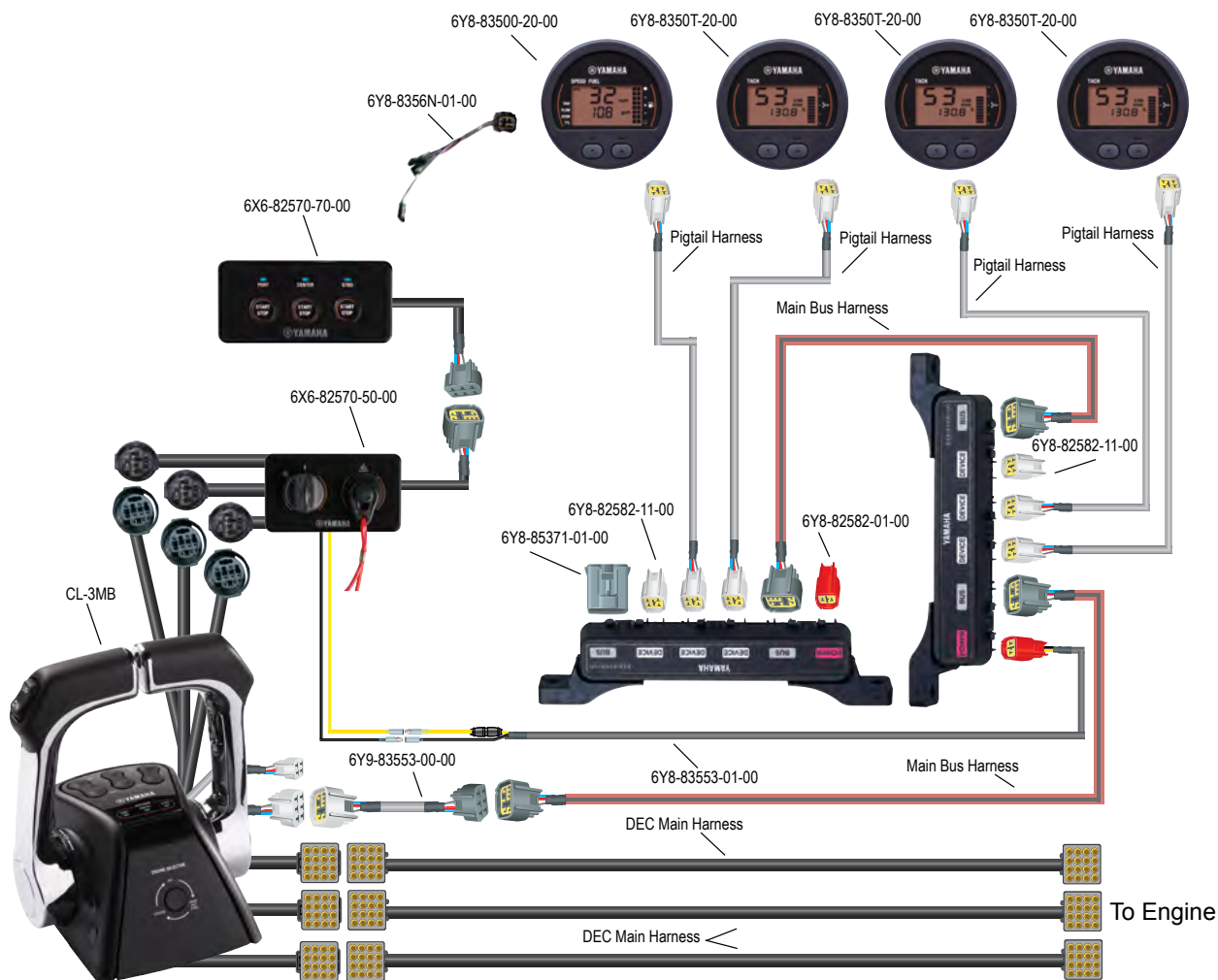

Parts order list for basic installation:

Quantity	Description	Part Number
1	Command Link Plus® Triple Main Station Control	CL-3MB
1	Triple Engines Key Switch Kit	6X6-W0035-60-00
1	Command Link® DEC Triple Main Station Gauge Kit	6X6-0E83R-41-00
3	DEC Main Harness	See List ¹
4	Pigtail Harness, Hub to Gauges	See List ²
1	Main Bus Harness, Rear Hub to Front Hub	See List ³
1	Main Bus Harness, Control Box Adaptor to Hub	See List ³

¹ DEC Main Harnesses	
20 ft.	6X6-8258A-00-00
23 ft.	6X6-8258A-10-00
26 ft.	6X6-8258A-20-00
33.5 ft.	6X6-8258A-30-00
39 ft.	6X6-8258A-40-00

² Pigtail Harnesses	
1 ft.	6Y8-82521-01-00
2 ft.	6Y8-82521-11-00
3 ft.	6Y8-82521-21-00
6 ft.	6Y8-82521-31-00
9 ft.	6Y8-82521-41-00
12 ft.	6Y8-82521-51-00

³ Main Bus Harnesses	
1 ft.	6Y8-82553-01-00
10 ft.	6Y8-82553-50-00
15 ft.	6Y8-82553-11-00
20 ft.	6Y8-82553-21-00
25 ft.	6Y8-82553-31-00
30 ft.	6Y8-82553-41-00

Triple Engine with CL7 Display & DEC Binnacle Mount Controls Command Link Plus®

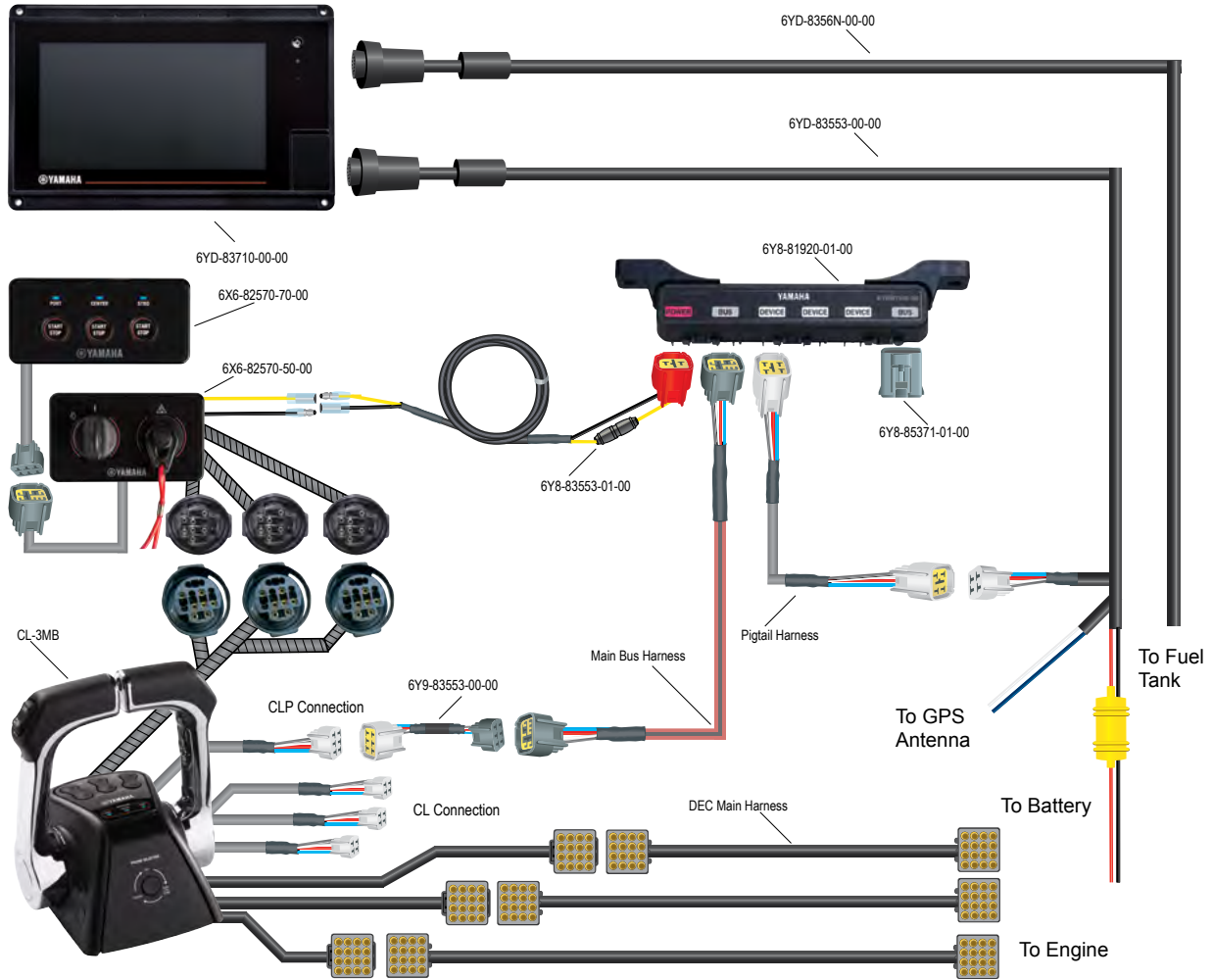

Parts order list for basic installation:

Quantity	Description	Part Number
1	Command Link Plus® Triple Main Station Control	CL-3MB
1	Twin Engines Key Switch Kit	6X6-W0035-60-00
1	CL7 -Command Link Plus® Display Kit	MAR-CL7DU-KT-00
1	CL7 - Command Link Plus® Display Installation Kit	MAR-CL7DI-KT-20
3	DEC Main Harness	See List ¹
1	Main Bus Harness, Control Box Adaptor to Hub	See List ²
1	Pigtail Harness, Hub to Display Harness	See List ³

¹ DEC Main Harnesses

20 ft.	6X6-8258A-00-00
23 ft.	6X6-8258A-10-00
26 ft.	6X6-8258A-20-00
33.5 ft.	6X6-8258A-30-00
39 ft.	6X6-8258A-40-00

² Main Bus Harnesses

1 ft.	6Y8-82553-01-00
10 ft.	6Y8-82553-50-00
15 ft.	6Y8-82553-11-00
20 ft.	6Y8-82553-21-00
25 ft.	6Y8-82553-31-00
30 ft.	6Y8-82553-41-00

³ Pigtail Harnesses

1 ft.	6Y8-82521-01-00
2 ft.	6Y8-82521-11-00
3 ft.	6Y8-82521-21-00
6 ft.	6Y8-82521-31-00
9 ft.	6Y8-82521-41-00
12 ft.	6Y8-82521-51-00

Triple Engines with DEC Controls - 2nd Station

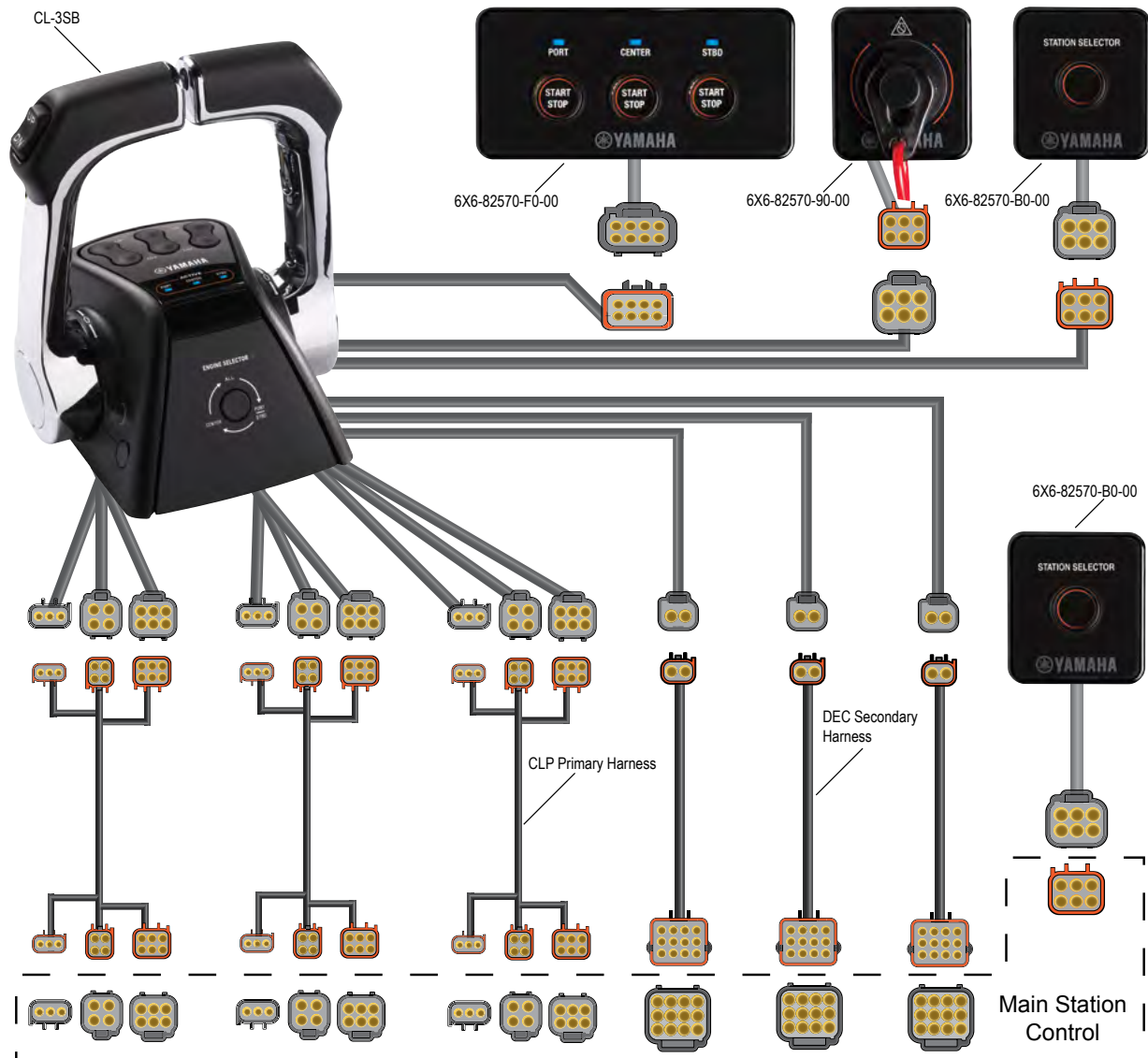

Parts order list for basic installation:

Quantity	Description	Part Number
1	Command Link Plus® 2 nd Station Triple Engine Control Box	CL-3SB
1	Command Link Plus® 2 nd Station Switch Set	6X6-W0035-90-00
3	CLP Primary Harness	See List ¹
3	DEC Secondary Harness	See List ²

¹ CLP Primary Harness

16 ft.	6X6-8258A-G1-00
26 ft.	6X6-8258A-H1-00
40 ft.	6X6-8258A-J1-00

² DEC Secondary Harness

16 ft.	6X6-8258A-B1-00
26 ft.	6X6-8258A-D1-00
40 ft.	6X6-8258A-F1-00

Adding a Multi-Hub

If there are no unused "Device Ports" on the Multi-Hubs already installed, before adding additional accessories or gauges to the network another Multihub must be added.



Parts order list for basic installation:

Quantity	Description	Part Number
1	Multi-Hub	6Y8-81920-01-00
1	Main Bus Harness	See List ¹

¹ Main Bus Harnesses

1 ft.	6Y8-82553-01-00
10 ft.	6Y8-82553-50-00
15 ft.	6Y8-82553-11-00
20 ft.	6Y8-82553-21-00
25 ft.	6Y8-82553-31-00
30 ft.	6Y8-82553-41-00

Adding a Gateway

Adding a Gateway to the Digital Network requires one open "Device" port. If no open port exist, a Multi-Hub must also be added.

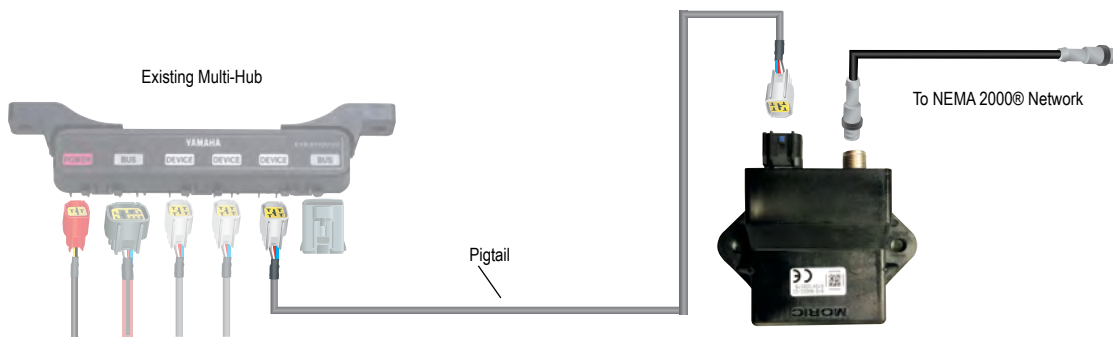

Parts order list for basic installation:

Quantity	Description	Part Number
1	Command Link® / Command Link Plus® Gateway	MAR-GTWAY-KT-10

Kit includes 2 ft. Pigtail Harness (6Y8-82521-11-00) and NEMA 2000® Wirelead (6YG-82521-00-00)

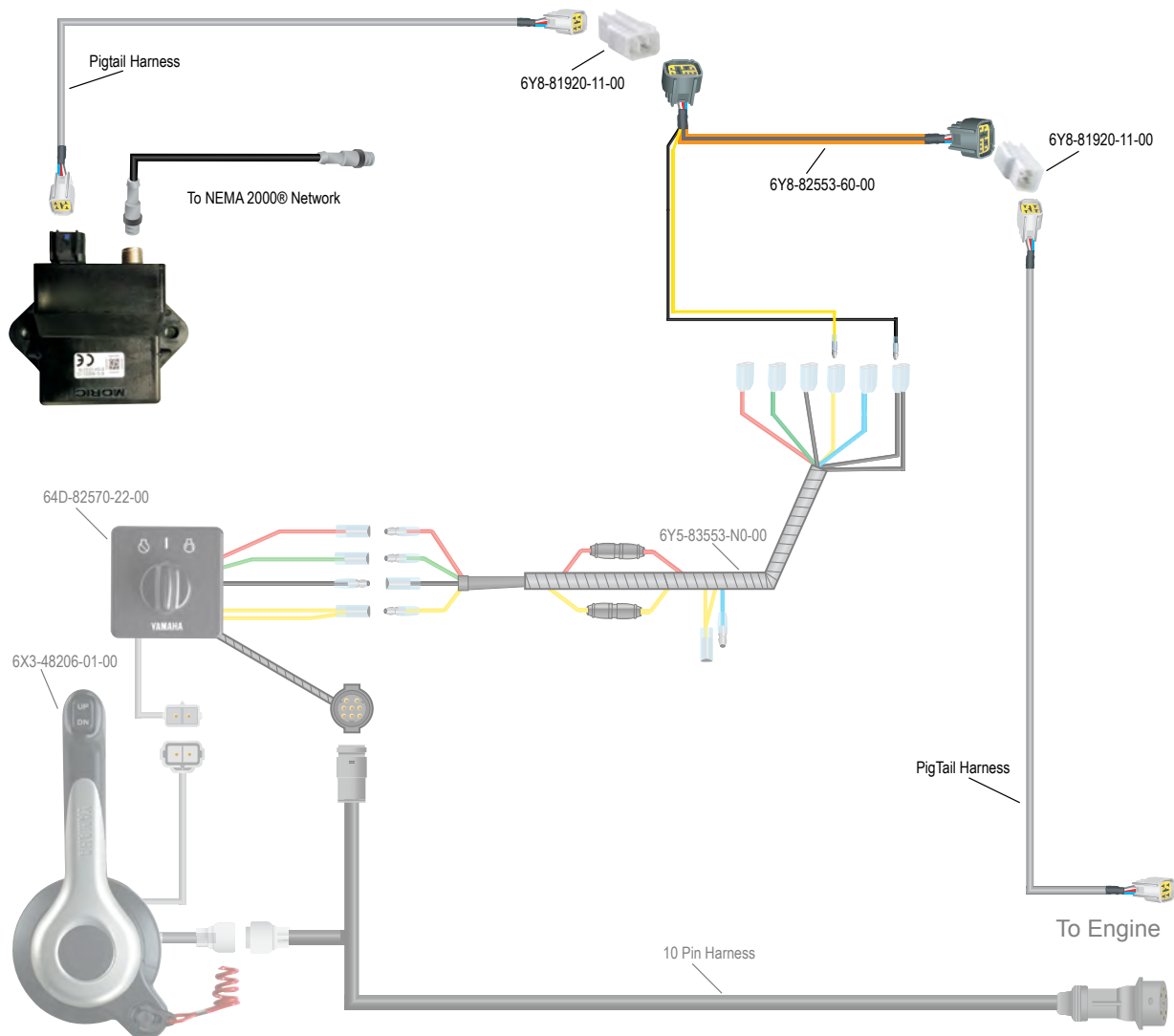

Parts order list for basic installation:

Quantity	Description	Part Number
1	Command Link® / Command Link Plus® Gateway	MAR-GTWAY-KT-10
2	Inline Hub	6Y8-81920-11-00
1	Orange Extension Harness (14 ft.)	6Y8-82553-60-00
1	Pigtail Harness	See List ¹

¹ Pigtail Harnesses

1 ft.	6Y8-82521-01-00
2 ft.	6Y8-82521-11-00
3 ft.	6Y8-82521-21-00
6 ft.	6Y8-82521-31-00
9 ft.	6Y8-82521-41-00
12 ft.	6Y8-82521-51-00

Kit includes 2 ft. Pigtail Harness (6Y8-82521-11-00) and NMEA 2000® Wirelead (6YG-82521-00-00)

Adding a AGI (Analog Gauge Interface)

Adding an AGI to the Digital Network requires one open "Device" port. If no open port exist, a Multi-Hub must also be added.



Parts order list for basic installation:

Quantity	Description	Part Number
1	Command Link® / Command Link Plus® AGI	6Y9-8A2D0-30-00
1	Pigtail Harness	See List ¹

¹ Pigtail Harnesses

- 1 ft. 6Y8-82521-01-00
- 2 ft. 6Y8-82521-11-00
- 3 ft. 6Y8-82521-21-00
- 6 ft. 6Y8-82521-31-00
- 9 ft. 6Y8-82521-41-00
- 12 ft. 6Y8-82521-51-00

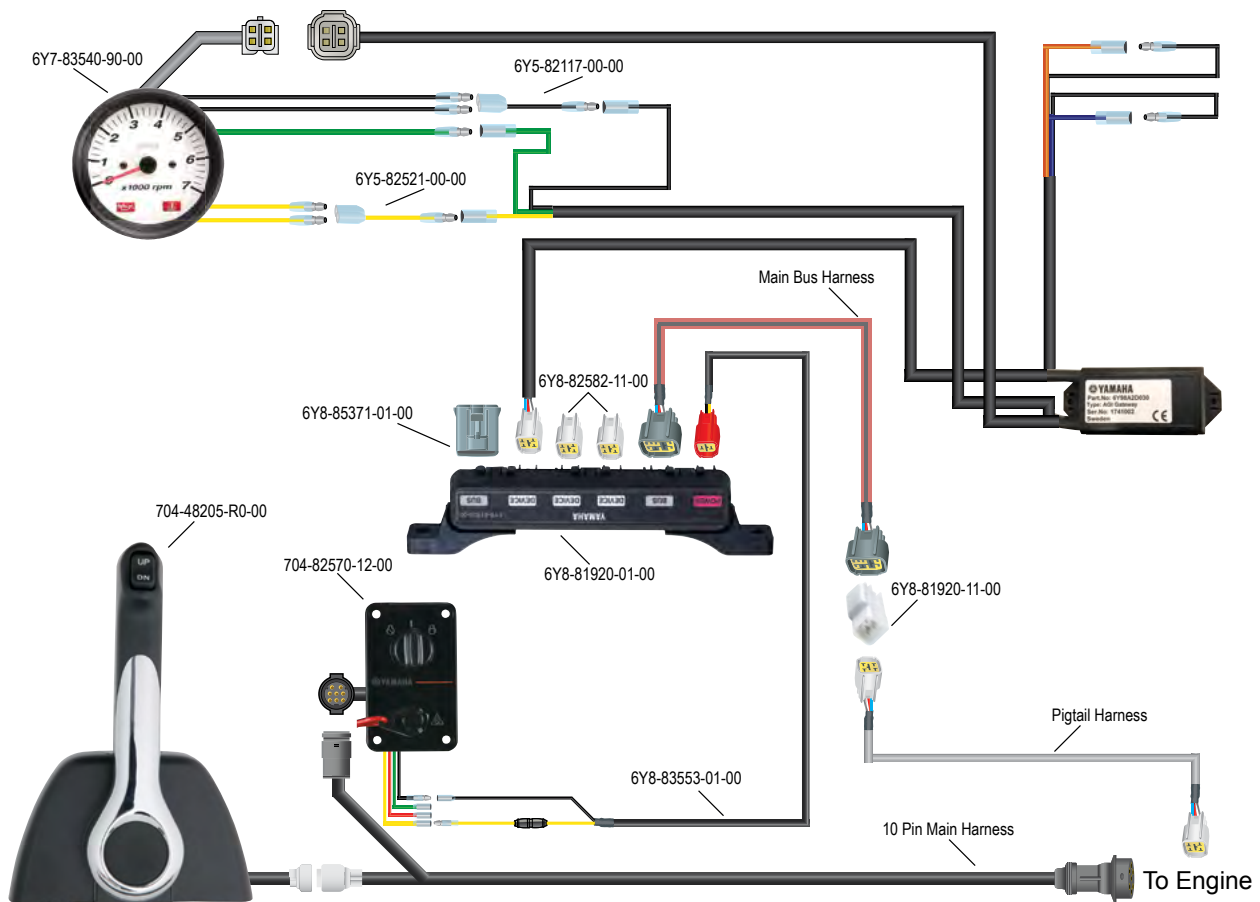

Adding a Multisensor

Adding a Multisensor to the Digital Network requires one open "BUS" port. If no open port exists, refer to the diagram on the next page (The "Bus" ports maybe come full with a CLP network installed on a second station).

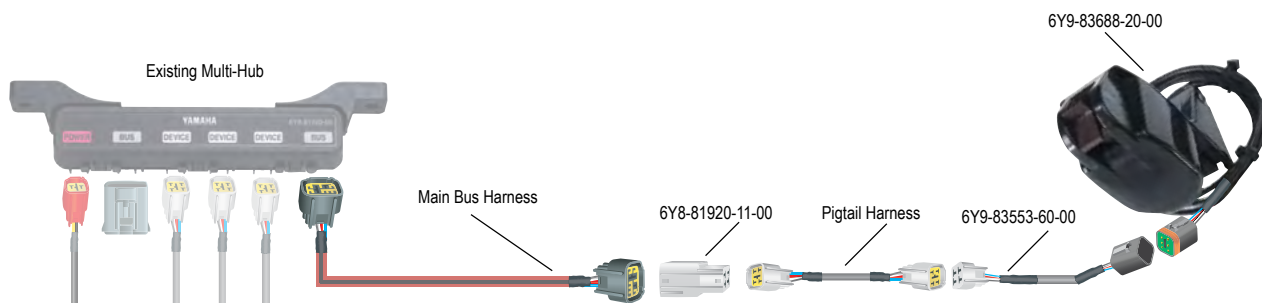

Parts order list for basic installation:

Quantity	Description	Part Number
1	Command Link Plus® Multisensor Kit	MAR-3DCER-KT-00
1	Main Bus Harness	See List ¹

¹ Main Bus Harnesses

1 ft.	6Y8-82553-01-00
10 ft.	6Y8-82553-50-00
15 ft.	6Y8-82553-11-00
20 ft.	6Y8-82553-21-00
25 ft.	6Y8-82553-31-00
30 ft.	6Y8-82553-41-00

Adding a Multisensor to the Digital Network requires one open "BUS" port. When no open port exists refer to this diagram.

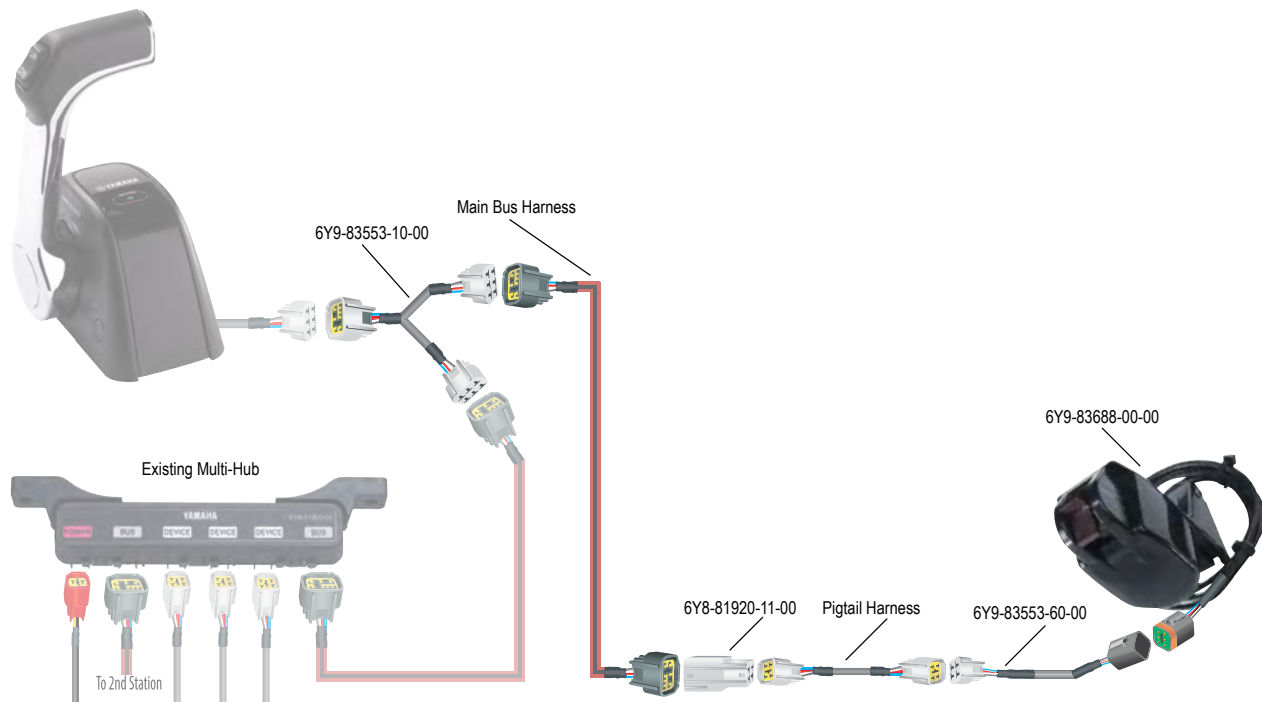

Parts order list for basic installation:

Quantity	Description	Part Number
1	Command Link Plus® Multisensor Kit	MAR-3DCER-KT-00
1	Command Link Plus® Y Adaptor	6Y9-83553-10-00
1	Main Bus Harness	See List ¹

¹ Main Bus Harnesses

1 ft.	6Y8-82553-01-00
10 ft.	6Y8-82553-50-00
15 ft.	6Y8-82553-11-00
20 ft.	6Y8-82553-21-00
25 ft.	6Y8-82553-31-00
30 ft.	6Y8-82553-41-00

Y-COP® Installations

Y-COP® installed with a Single Engine

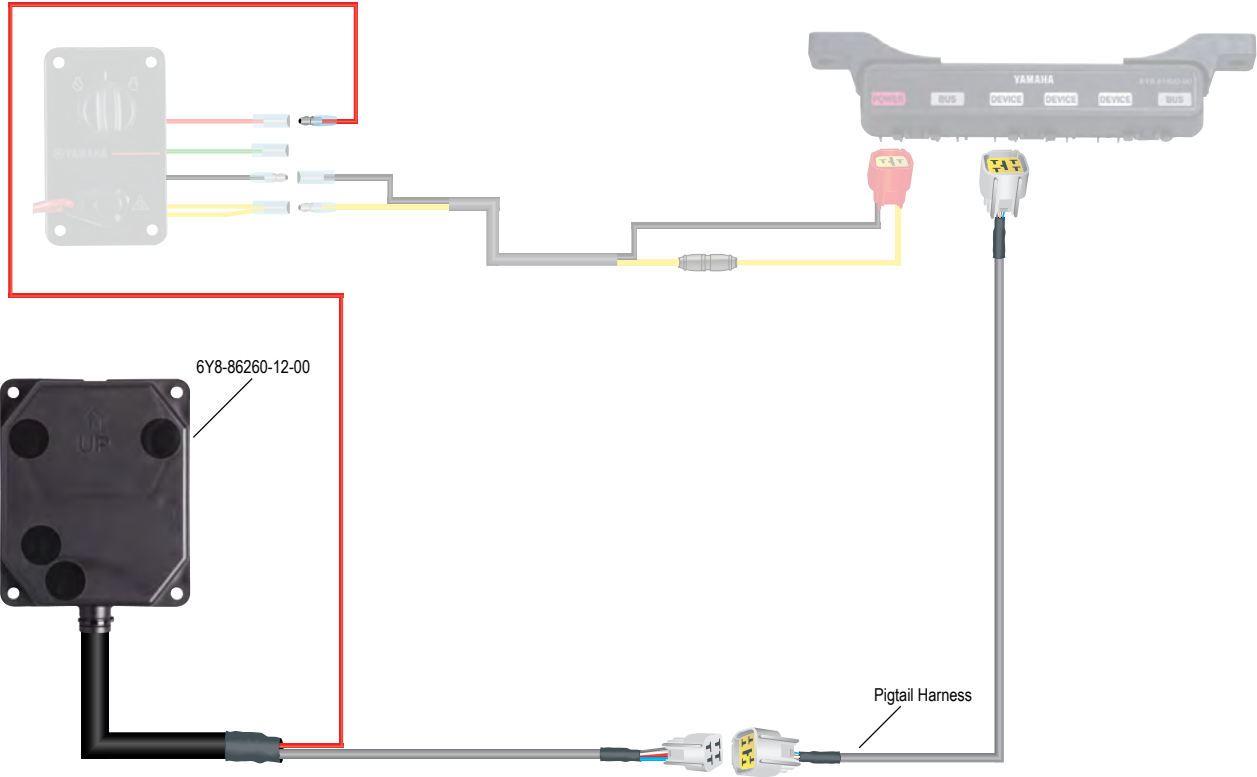

Parts order list for basic installation:

Quantity	Description	Part Number
1	Y-COP® Kit	6Y8-W0035-87-00
1	Pigtail Harness	See List ¹

¹ Pigtail Harnesses

- 1 ft. 6Y8-82521-01-00
- 2 ft. 6Y8-82521-11-00
- 3 ft. 6Y8-82521-21-00
- 6 ft. 6Y8-82521-31-00
- 9 ft. 6Y8-82521-41-00
- 12 ft. 6Y8-82521-51-00

Y-COP® installed with Twin or Triple installations with Command Link® Main Switches

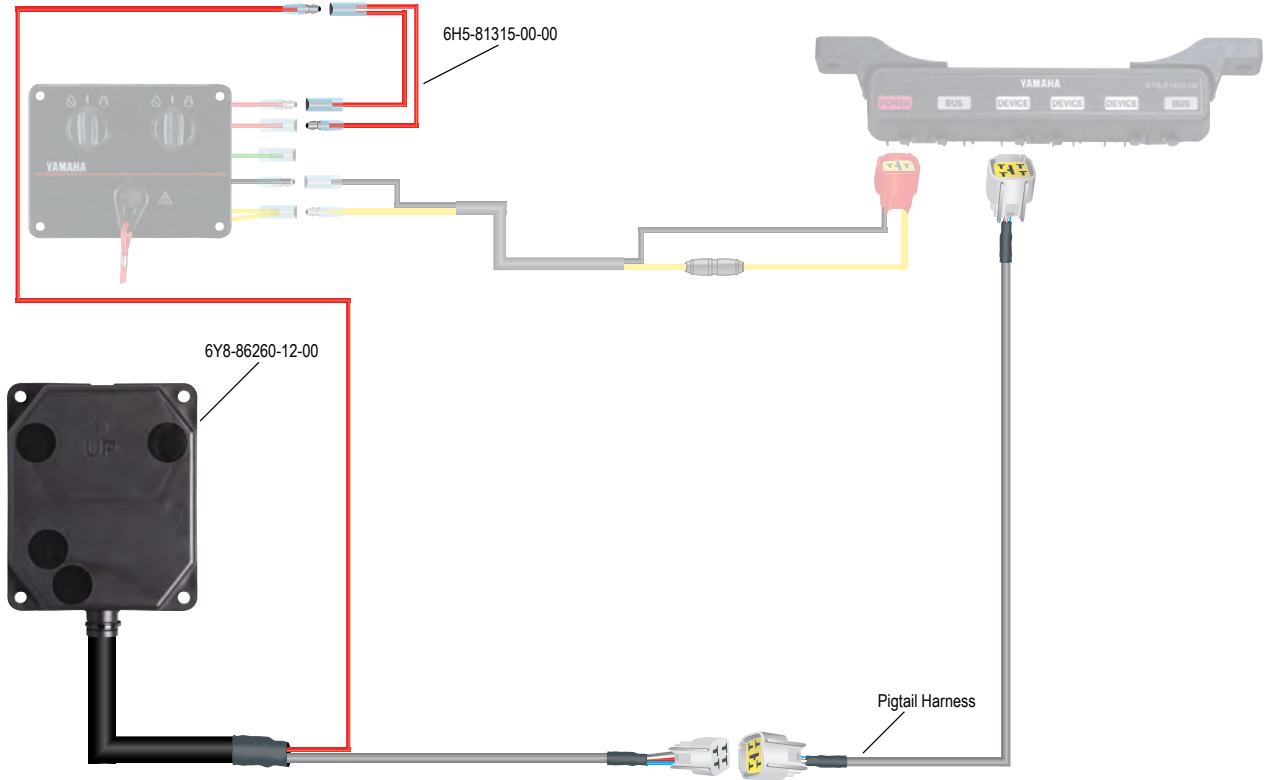

Parts order list for basic installation:

Quantity	Description	Part Number
1	Y-COP® Kit	6Y8-W0035-87-00
1	Adaptor Harness	6H5-81315-00-00
1	Pigtail Harness	See List ¹

¹ Pigtail Harnesses

1 ft.	6Y8-82521-01-00
2 ft.	6Y8-82521-11-00
3 ft.	6Y8-82521-21-00
6 ft.	6Y8-82521-31-00
9 ft.	6Y8-82521-41-00
12 ft.	6Y8-82521-51-00

General Information

Rigging Estimate Guide (Diagrams)

Rigging Components

Electrical Components

Engine Accessories

Propellers

Maintenance Items

Oils & Lubes

Detailing & Trailer Supplies

Accessories & Apparel

Generators & Accessories

Rigging Estimate Guide

General Information

Rigging Estimate Guide (Diagrams)

Rigging Components

Electrical Components

Engine Accessories

Propellers

Maintenance Items

Oils & Lubes

Detailing & Trailer Supplies

Accessories & Apparel

Generators & Accessories

Y-COP® installed with Twin or Triple installations with Command Link Plus® Main Switches

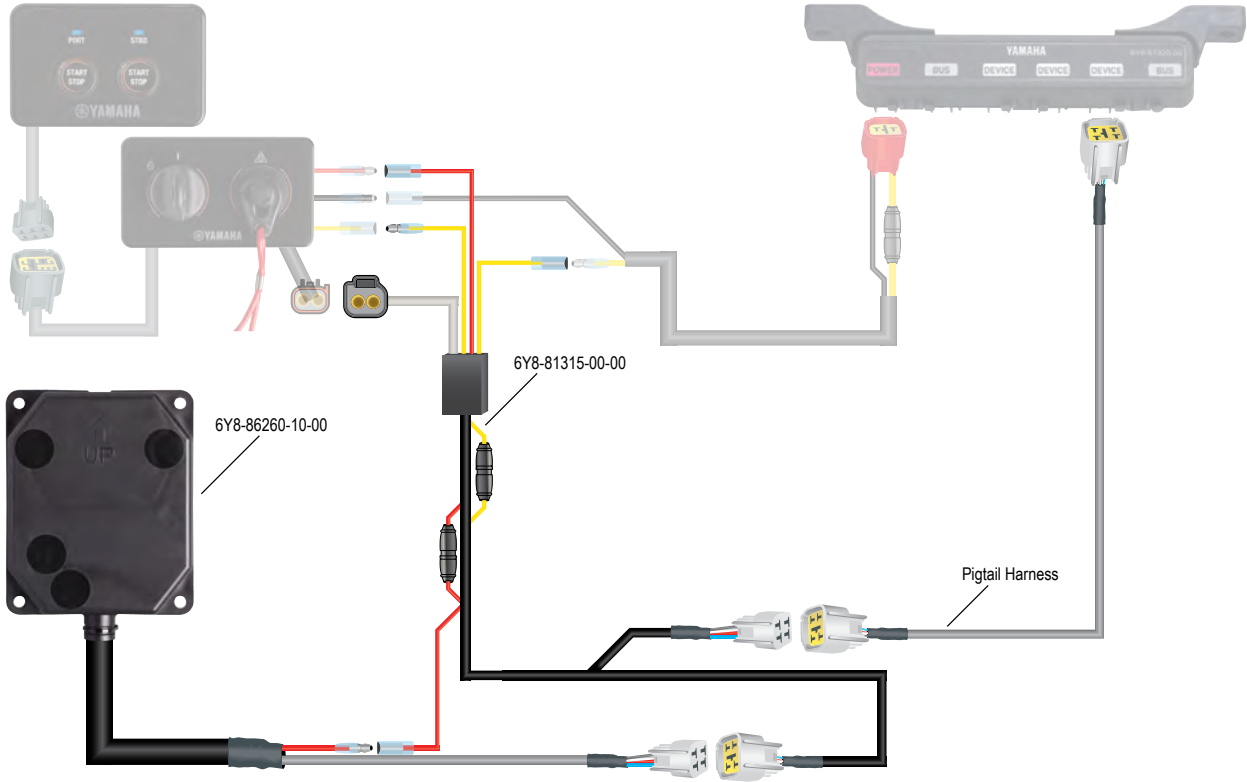

Parts order list for basic installation:

Quantity	Description	Part Number
1	Y-COP® Kit	6Y8-W0035-87-00
1	Adaptor Harness	6Y8-81315-01-00
1	Pigtail Harness	See List ¹

¹ Pigtail Harnesses

1 ft.	6Y8-82521-01-00
2 ft.	6Y8-82521-11-00
3 ft.	6Y8-82521-21-00
6 ft.	6Y8-82521-31-00
9 ft.	6Y8-82521-41-00
12 ft.	6Y8-82521-51-00



Description	Page
Gauges	3-1
Digital Electronic Control Gauges Kits	3-6
Command Link® Gauge Kits	
Single Engine Gauge Kits	3-9
Twin Engine Gauge Kits	3-12
Multifunction Gauge Kits	
Single Engine Gauge Kits	3-13
Helm Master® Main Station Kits	3-14
Helm Master® Second Station Kits	3-17
Helm Master® Steering Kits	3-20
Control Boxes	
DEC (Digital Electronic Control) Control Boxes	3-21
Mechanical Control Boxes	3-22
Tiller Handles	3-24
Control Cables	3-25
Control Cable Ends	3-26
Main Switches	
Command Link Plus® Main Switches	3-27
Command Link® and Conventional Main Station Switches	3-29
Command Link® and Conventional Second Station Switch Panels	3-31
Replacement Keys, Covers, and Caps	3-32

General Information

Rigging Estimate Guide (Diagrams)

Rigging Components

Electrical Components

Engine Accessories

Propellers

Maintenance Items

Oils & Lubes

Detailing & Trailer Supplies

Accessories & Apparel

Generators & Accessories



Gauges



Command Link Plus® CL7 Touchscreen Display

The new Command Link Plus® display has now been integrated with the latest technology in a touchscreen display and dual GPS mapping. This display has a 7 inch full color display that will display up to four engines and up to six tanks.

Basic Maps - 6YD-83710-00-00

Detail Maps - 6YD-83710-10-00

Replacement Cover: **6YD-87278-00-00**



6YC Information Station

Today's boater demands convenience, and insists on accurate and instant information about boat and outboard systems. With the plethora of modern electronics, the call is for more information and more available dash space than ever before. Yamaha answers the call with the all-new 6YC "Information Station" display.

6YC-83710-02-00

Replacement Cover: 6YC-87278-00-00



Command Link Plus® / Command Link® Round Gauges

Yamaha's integrated information systems are simple, streamlined and sophisticated. These new multi network gauges make the rigging process simple as well by working in both Command Link Plus® and Command Link® networks. Allows the use of the NEW F150's Variable Trolling Speed

Round Tachometer: 6Y8-8350T-20-00

Round Speed Fuel Meter: 6Y8-83500-20-00

* Part number is for gauge(s) only.

Digital Multifunction Tachometer

Accurate information is available to let you fine tune settings to achieve the best overall efficiency and performance for operating conditions. Designed for optimum visibility and long-term durability. Displays: engine rpm, trim angle, oil level, warning lamps, overheat warning lamp, hour meter for trip (reset able) and total operating hours.

6Y5-8350T-D0-00*



Digital Multifunction Speedometer

Accurate information is available to let you fine tune settings to achieve the best overall efficiency and performance for operating conditions. Designed for optimum visibility and long-term durability. Displays: Speed, trip, time, fuel, low fuel warning-flashes on the lowest bar, battery voltage reading-displays battery output (10~16 volts) and flashes the readout if the output falls below 12 volts.

6Y5-83570-A0-00*



Digital Multifunction Fuel Management Meter

Accurate information is available to let you fine tune settings to achieve the best overall efficiency and performance for operating conditions. Designed for optimum visibility and long-term durability. Displays: Fuel consumption, fuel economy (using speedo or GPS input for readings), fuel contamination warning (when deluxe fuel/water separator is used), engine synchronization (for dual engine applications).

6Y5-8350F-B0-00*



Pro Series II™ Speedometer (0-50 MPH)

Yamaha's Pro Series II quality instrumentation provides you with high accuracy, and easy readability in virtually all conditions. Distinctive appearance will complement any dash. Direct faceplate illumination on gauge allows for easy night-time viewing. Displays KMH and MPH.

White Face - 6Y7-83510-30-00*

Black Face - 6Y7-83510-20-00*



Pro Series II™ Speedometer (0-75MPH)

Yamaha's Pro Series II quality instrumentation provides you with high accuracy, and easy readability in virtually all conditions. Distinctive appearance will complement any dash. Direct faceplate illumination on gauge allows for easy night-time viewing. Displays KMH and MPH.

White Face - 6Y7-83510-10-00*

Black Face - 6Y7-83510-00-00*



Pro Series II™ Tachometers

Yamaha's Pro Series II quality instrumentation provides you with high accuracy, and easy readability in virtually all conditions. Distinctive appearance will complement any dash. Direct faceplate illumination on gauge allows for easy night-time viewing. Warning indicators included in the gauge face.

White Face - 6Y7-83540-90-00*

Black Face - 6Y7-83540-80-00*



* Part number is for gauge(s) only.

- General Information
- Rigging Estimate Guide (Diagrams)
- Rigging Components**
- Electrical Components
- Engine Accessories
- Propellers
- Maintenance Items
- Oils & Lubes
- Detailing & Trailer Supplies
- Accessories & Apparel
- Generators & Accessories



Pro Series II™ Fuel Level Meter

High accuracy, and easy readability in virtually all conditions. Distinctive appearance will complement any dash. Direct faceplate illumination on gauge allows for easy night-time viewing.

White Face - 6Y7-85750-30-00*

Black Face - 6Y7-85750-10-00*



Pro Series II™ Voltage Meter

High accuracy, and easy readability in virtually all conditions. Distinctive appearance will complement any dash. Direct faceplate illumination on gauge allows for easy night-time viewing.

White Face - 6Y7-83503-10-00*

Black Face - 6Y7-83503-00-00*



Pro Series II™ Water Pressure Meter

High accuracy, and easy readability in virtually all conditions. Direct faceplate illumination on gauge allows for easy night-time viewing. Requires pressure sender (688-83667-00-00) for installation.

White Face - 6Y7-83660-30-00*

Black Face - 6Y7-83660-10-00*



Pro Series II™ Water Temperature Meter

High accuracy, and easy readability in virtually all conditions. Direct faceplate illumination on gauge allows for easy night-time viewing. Requires temperature sender (688-83591-00-00) for installation.

White Face - 6Y7-83590-10-00*

Black Face - 6Y7-83590-00-00*



Pro Series II™ Trim Meter

High accuracy, and easy readability in virtually all conditions. Direct faceplate illumination on gauge allows for easy night-time viewing.

White Face - 6Y7-83670-50-00*

Black Face - 6Y7-83670-40-00*



Pro Series II™ Hour Meter

High accuracy, and easy readability in virtually all conditions. Displays engine hours with an LCD read out.

White Face - 6Y7-83504-10-00*

Black Face - 6Y7-83504-00-00*

* Part number is for gauge(s) only.

Pro Series™ 50 MPH Speedometer

Yamaha's Pro Series quality instrumentation provides you with high accuracy, and easy readability in virtually all conditions. Direct faceplate illumination on gauges allows for easy night-time viewing. Displays MPH and KM/H.

6Y5-83510-10-00*



Pro Series™ 75 MPH Speedometer

Yamaha's Pro Series quality instrumentation provides you with high accuracy, and easy readability in virtually all conditions. Direct faceplate illumination on gauges allows for easy night-time viewing. Displays MPH and KM/H.

6Y5-83510-00-00*



Pro Series™ Tachometer

Yamaha's Pro Series quality instrumentation provides you with high accuracy, and easy readability in virtually all conditions. Direct faceplate illumination on gauges allows for easy night-time viewing.

6Y5-83540-14-00*



Pro Series™ Tachometer for Four-Stroke Engines

Yamaha's Pro Series quality instrumentation provides you with high accuracy, and easy readability in virtually all conditions. Direct faceplate illumination on gauges allows for easy night-time viewing. Includes oil pressure and over heat warning indicators.

6Y5-83540-20-00*



Pro Series™ Tachometer with Two-Stroke Oil Indicators

Yamaha's Pro Series quality instrumentation provides you with high accuracy, and easy readability in virtually all conditions. Direct faceplate illumination on gauges allows for easy night-time viewing.

6Y5-83540-05-00*



* Part number is for gauge(s) only.

General Information

Rigging Estimate Guide (Diagrams)

Rigging Components

Electrical Components

Engine Accessories

Propellers

Maintenance Items

Oils & Lubes

Detailing & Trailer Supplies

Accessories & Apparel

Generators & Accessories



Pro Series™ Fuel Level Meter

Yamaha's Pro Series quality instrumentation provides you with high accuracy, and easy readability in virtually all conditions. Direct faceplate illumination on gauges allows for easy night-time viewing.

6Y5-85750-10-00*



Pro Series™ Voltage Meter

Yamaha's Pro Series quality instrumentation provides you with high accuracy, and easy readability in virtually all conditions. Direct faceplate illumination on gauges allows for easy night-time viewing.

6Y5-83503-00-00*



Pro Series™ Water Temperature Meter

Yamaha's Pro Series quality instrumentation provides you with high accuracy, and easy readability in virtually all conditions. Direct faceplate illumination on gauges allows for easy night-time viewing. Requires temperature sender (688-83591-00-00) for installation.

6Y5-83590-00-00*



Pro Series™ Water Pressure Meter

Yamaha's Pro Series quality instrumentation provides you with high accuracy, and easy readability in virtually all conditions. Direct faceplate illumination on gauges allows for easy night-time viewing. Requires pressure sender (688-83667-00-00) for installation.

6Y5-83660-10-00*



Pro Series™ Trim Meter

Yamaha's Pro Series quality instrumentation provides you with high accuracy, and easy readability in virtually all conditions. Direct faceplate illumination on gauges allows for easy night-time viewing. Requires pressure sender.

3 Wire Sender - 6Y5-83670-11-00*

2 Wire Sender - 6Y5-83670-12-00*



Pro Series™ Hour Meter

Yamaha's Pro Series quality instrumentation provides you with high accuracy, and easy readability in virtually all conditions.

6Y5-83504-11-00*

* Part number is for gauge(s) only.

Digital Electronic Control (DEC) Gauge Kits

Yamaha's DEC gauge kits offer you convenient rigging solutions. There are several configurations to meet most applications, and offer a great price advantage over individual components. Most installations will require additional parts, see section 10 for additional rigging information.

Command Link Plus® CL7 Display Kit (Basic Maps)

MAR-CL7DU-KT-01

Kit Includes:

Qty	Description	Part Number
1	Command Link Plus® CL7 Display	6YD-83710-01-00
1	Command Link Plus® Main Bus Adapter Harness	6Y9-83553-00-00
1	Display Cover	6YD-87278-00-00



Command Link Plus® CL7 Display Kit (Detailed Maps)

MAR-CL7DU-KT-11

Kit Includes:

Qty	Description	Part Number
1	Command Link Plus® CL7 Display	6YD-83710-11-00
1	Command Link Plus® Main Bus Adapter Harness	6Y9-83553-00-00
1	Display Cover	6YD-87278-00-00



Command Link Plus® CL7 Display Installation Kit

MAR-CL7D1-KT-20

Kit Includes:

Qty	Description	Part Number
1	Multi Hub	6Y8-81920-01-00
1	Cap 1, 4 Pin	6Y8-82582-11-00
1	8 ft Power Lead	6Y8-83553-01-00
1	GPS Lead / Power	6YD-83553-00-00
1	Fuel Tank Sender Lead	6YD-8356N-00-00



General Information

Rigging Estimate Guide (Diagrams)

Rigging Components

Electrical Components

Engine Accessories

Propellers

Maintenance Items

Oils & Lubes

Detailing & Trailer Supplies

Accessories & Apparel

Generators & Accessories



Command Link Plus® Installation Kit MAR-CLPDI-KT-10

Kit Includes:

Qty	Description	Part Number
1	Wire Lead for GPS	6Y9-8356N-01-00
1	Wire Lead for Fuel Tank Sender	6Y9-8356N-10-00
1	Wire Lead for CLP, Control Box to Main Bus	6Y9-83553-00-00
1	Multi-Hub Assembly	6Y8-81920-01-00
1	Cap, 4 Pin	6Y8-82582-11-00
1	Power Lead, 8 ft.	6Y8-83553-01-00
1	Wiring Diagram	6Y9-2819K-E0-00



6YC Display Single / Twin Engine DEC Kit 6X6-0E83C-00-00

Kit Includes:

Qty	Description	Part Number
1	6YC Display	6YC-83710-02-00
1	Multi-Hub Assembly	6Y8-81920-01-00
2	Cap, 4 Pin	6Y8-82582-11-00
1	Power Lead, 8 ft.	6Y8-83553-01-00
1	Fuel Sender and GPS Wire Lead	6Y8-8356N-01-00
1	Wire Lead for CLP, Control Box to Main Bus	6Y9-83553-00-00
1	6YC Meter Guide	6YC-2819U-70-E0



DEC Single Engine Main Station Command Link® Kit Round Two Gauge Kit: 6X6-0E83R-21-00

Kit Includes:

Qty	Description	Part Number
1	Tachometer Assy.	6Y8-8350T-20-00
1	Meter Assy. (Speed/Fuel)	6Y8-83500-20-00
1	Multi-Hub Assembly	6Y8-81920-01-00
1	Power Lead, 8 ft.	6Y8-83553-01-00
1	Cap, 4 Pin	6Y8-82582-11-00
1	Fuel Sender and GPS Wire Lead	6Y8-8356N-01-00
1	User Operation Guide	6Y8-2819W-70-E0
1	CLP wire 1ft	6Y9-83553-00-00
1	Main Bus Harness, 1ft	6Y8-82553-01-00

(Most installations will require additional parts, see section 2 for additional rigging information)

DEC Twin Engine Main Station Command Link® Kit Round Three Gauge Kit: 6X6-0E83R-31-00

Kit Includes:

Qty	Description	Part Number
2	Tachometer Assy.	6Y8-8350T-20-00
1	Meter Assy. (Speed/Fuel)	6Y8-83500-20-00
1	Multi-Hub Assembly	6Y8-81920-01-00
1	Power Lead, 8 ft.	6Y8-83553-01-00
1	Main Bus Harness, 1ft	6Y8-82553-01-00
1	Fuel Sender and GPS Wire Lead	6Y8-8356N-01-00
1	User Operation Guide	6Y8-2819W-70-E0
1	CLP wire 1ft	6Y9-83553-00-00



DEC Triple Engine Main Station Command Link® Kit Round Four Gauge Kit: 6X6-0E83R-41-00

Kit Includes:

Qty	Description	Part Number
3	Tachometer Assy.	6Y8-8350T-20-00
1	Meter Assy. (Speed/Fuel)	6Y8-83500-20-00
2	Multi-Hub Assembly	6Y8-81920-01-00
1	Power Lead, 8 ft.	6Y8-83553-01-00
1	Cap, 2 Pin	6Y8-82582-01-00
2	Cap, 4 Pin	6Y8-82582-11-00
2	Main Bus Harness, 1ft	6Y8-82553-01-00
1	Fuel Sender and GPS Wire Lead	6Y8-8356N-01-00
1	User Operation Guide	6Y8-2819W-70-E0
1	CLP wire 1ft	6Y9-83553-00-00



(Most installations will require additional parts, see section 2 for additional rigging information)

Command Link® Single Engine Gauge Kits



Command Link® Single Engine Gauge Kit

(This kit DOES NOT allow for accessories like a gateway to be added)

Round One Gauge Kit: 6Y8-0E83R-81-00

Kit Includes:

Qty	Description	Part Number
1	Tachometer Assy.	6Y8-8350T-20-00
1	Orange Main Buss With Power Lead (14ft)	6Y8-82553-60-00
1	Dual Fuse Harness	6Y5-83553-N0-00
1	Pigtail Harness, 1 ft.	6Y8-82521-01-00
1	Pigtail Harness, 12 ft.	6Y8-82521-51-00
2	Single hub	6Y8-81920-11-00
1	User Operation Guide	6Y8-2819W-70-E0



Command Link® Single Engine Gauge Kit

Round One Gauge Kit: 6Y8-0E83R-61-00

Kit Includes:

Qty	Description	Part Number
1	Tachometer Assy.	6Y8-8350T-20-00
2	Multi-Hub Assembly	6Y8-81920-01-00
1	Power Lead, 8 ft.	6Y8-83553-01-00
1	Cap, 2 Pin	6Y8-82582-01-00
4	Cap, 4 Pin	6Y8-82582-11-00
1	Pigtail Harness, Engine to Rear Hub, 9 ft.	6Y8-82521-41-00
1	User Operation Guide	6Y8-2819W-70-E0



Command Link® Single Engine Gauge Kit

(This kit DOES NOT allow for accessories like a gateway to be added)

Round Two Gauge Kit: 6Y8-0E83R-91-00

Kit Includes:

Qty	Description	Part Number
1	Tachometer Assy.	6Y8-8350T-20-00
1	Meter Assy. (Speed/Fuel)	6Y8-83500-20-00
1	Y-Split	6Y8-82521-80-00
1	Dual Fuse Harness	6Y5-83553-N0-00
1	Orange Main Buss With Power Lead (14ft)	6Y8-82553-60-00
2	Single hub	6Y8-81920-11-00
1	Pigtail Harness, 12 ft.	6Y8-82521-51-00
1	Fuel Sender and GPS Wire Lead	6Y8-8356N-01-00
1	Speed Sensor Kit	60V-8A4L1-18-00
1	User Operation Guide	6Y8-2819W-70-E0

(Most installations will require additional parts, see section 2 for additional rigging information)

Command Link® Single Engine Gauge Kit Round Two Gauge Kit: 6Y8-0E83R-71-00

Kit Includes:

Qty	Description	Part Number
1	Tachometer Assy.	6Y8-8350T-20-00
1	Meter Assy. (Speed/Fuel)	6Y8-83500-20-00
1	Multi-Hub Assembly	6Y8-81920-01-00
1	In-Line Hub	6Y8-81920-11-00
1	Power Lead, 8 ft.	6Y8-83553-01-00
1	Cap, 4 Pin	6Y8-82582-11-00
1	Speed Sensor Kit	60V-8A4L1-18-00
1	Fuel Sender and GPS Wire Lead	6Y8-8356N-01-00
1	Pigtail Harness, Engine to Rear Hub, 6 ft.	6Y8-82521-31-00
1	User Operation Guide	6Y8-2819W-70-E0



Command Link® Single Engine Gauge Kit Round Two Gauge Kit: 6Y8-0E83R-41-00

Kit Includes:

Qty	Description	Part Number
1	Tachometer Assy.	6Y8-8350T-20-00
1	Meter Assy. (Speed/Fuel)	6Y8-83500-20-00
2	Multi-Hub Assembly	6Y8-81920-01-00
1	Power Lead, 8 ft.	6Y8-83553-01-00
1	Cap, 2 Pin	6Y8-82582-01-00
3	Cap, 4 Pin	6Y8-82582-11-00
1	Speed Sensor Kit	60V-8A4L1-18-00
1	Fuel Sender and GPS Wire Lead	6Y8-8356N-01-00
1	Pigtail Harness, Engine to Rear Hub, 12 ft.	6Y8-82521-51-00
1	User Operation Guide	6Y8-2819W-70-E0



Command Link® Single Engine 6YC Display Kit with In-Line Hub

6YC Kit: 6YC-0E83C-30-00

Kit Includes:

Qty	Description	Part Number
1	6YC Display	6YC-83710-02-00
1	Multi-Hub Assembly	6Y8-81920-01-00
1	InLine Hub	6Y8-81920-11-00
2	Cap, 4 Pin	6Y8-82582-11-00
1	Power Lead, 8 ft.	6Y8-83553-01-00
1	Fuel Sender and GPS Wire Lead	6Y8-8356N-01-00
1	6 ft. Pig Tail, Engine to rear hub	6Y8-82521-31-00
1	Speed Sensor Kit	60V-8A4L1-18-00
1	6YC Meter Guide	6YC-2819U-70-E0



(Most installations will require additional parts, see section 2 for additional rigging information)



Command Link® Single Engine 6YC Display Kit

6YC Kit: 6YC-0E83C-00-00

Kit Includes:

Qty	Description	Part Number
1	6YC Display	6YC-83710-02-00
2	Multi-Hub Assembly	6Y8-81920-01-00
4	Cap, 4 Pin	6Y8-82582-11-00
1	Cap, 2 Pin	6Y8-82582-01-00
1	Power Lead, 8 ft.	6Y8-83553-01-00
1	Fuel Sender and GPS Wire Lead	6Y8-8356N-01-00
1	12 ft. Pig Tail, Engine to rear hub	6Y8-82521-51-00
1	Speed Sensor Kit	60V-8A4L1-18-00
1	6YC Meter Guide	6YC-2819U-70-E0



Command Link® Single Engine 6YC Display Kit with 704 Control Box

6YC Kit: 6YC-0E83C-10-00

Kit Includes:

Qty	Description	Part Number
1	6YC Display	6YC-83710-02-00
1	704 Single Binicale Control Box	704-48205-R0-00
1	Single Engine Main Switch	704-82570-12-00
2	Multi-Hub Assembly	6Y8-81920-01-00
4	Cap, 4 Pin	6Y8-82582-11-00
1	Cap, 2 Pin	6Y8-82582-01-00
1	Power Lead, 8 ft.	6Y8-83553-01-00
1	Fuel Sender and GPS Wire Lead	6Y8-8356N-01-00
1	12 ft. Pig Tail, Engine to rear hub	6Y8-82521-51-00
1	23ft. 10 Pin Main Harness	688-8258A-70-00
1	Speed Sensor Kit	60V-8A4L1-18-00
1	6YC Meter Guide	6YC-2819U-70-E0

(Most installations will require additional parts, see section 2 for additional rigging information)

Command Link® Twin Engine Gauge Kits

Command Link® Twin Engine Gauge Kit with 704 Control Box Round Three Gauge Kit: 6Y8-0E83R-51-00

Kit Includes:

Qty	Description	Part Number
2	Tachometer Assy.	6Y8-8350T-20-00
1	Meter Assy. (Speed/Fuel)	6Y8-83500-20-00
2	Multi-Hub Assembly	6Y8-81920-01-00
1	Power Lead, 8 ft.	6Y8-83553-01-00
1	Cap, 2 Pin	6Y8-82582-01-00
1	Cap, 4 Pin	6Y8-82582-11-00
1	Speed Sensor Kit	60V-8A4L1-18-00
1	704 Twin Engine Binnacle Control Box	704-48207-R0-00
1	Twin Engine Main Switch Panel Assembly	6Y8-82570-04-00
1	Fuel Sender and GPS Wire Lead	6Y8-8356N-01-00
1	Main Wire Harness, 10 Pin, 26.2 ft.	6K1-8258A-40-00
1	Main Wire Harness, 10 Pin, 31.2 ft.	61B-8258A-01-00
2	Pigtail Harness, Engine to Rear Hub, 12 ft.	6Y8-82521-51-00
1	User Operation Guide	6Y8-2819W-70-E0



Command Link® Twin Engine 6YC Display Kit with 704 Control Box

6YC Kit: 6YC-0E83C-20-00

Kit Includes:

Qty	Description	Part Number
1	6YC Display	6YC-83710-02-00
1	704 Twin Binicale Control Box	704-48207-R0-00
1	Twin Engine Main Switch	6Y8-82570-04-00
2	Multi-Hub Assembly	6Y8-81920-01-00
3	Cap, 4 Pin	6Y8-82582-11-00
1	Cap, 2 Pin	6Y8-82582-01-00
1	Power Lead, 8 ft.	6Y8-83553-01-00
1	Fuel Sender and GPS Wire Lead	6Y8-8356N-01-00
2	12 ft. Pig Tail, Engine to rear hub	6Y8-82521-51-00
1	31ft. 10 Pin Main Harness	61B-8258A-01-00
1	26ft. 10 Pin Main Harness	6K1-8258A-40-00
1	Speed Sensor Kit	60V-8A4L1-18-00
1	6YC Meter Guide	6YC-2819U-70-E0



(Most installations will require additional parts, see section 2 for additional rigging information)

Multifunction Gauge Kits



Multifunction Single Engine Tachometer Kit Multifunction One Gauge Kit: 6YR-W0035-E1-00

Kit Includes:

Qty	Description	Part Number
1	Multifunction Tachometer (~ 2004 Engines)	6Y5-8350T-D0-00
1	Trim and Oil Harness (~ 2004 Engines)	68F-82553-90-00
1	Gauge Harness, 2 Fuse	6Y5-83553-N0-00
1	Wire Harness Cap, Male	6R8-82582-00-00



Multifunction Single Engine Fuel Management Kit* Multifunction One Gauge Kit: 6Y5-W0088-55-00

Kit Includes:

Qty	Description	Part Number
1	Multifunction Fuel Management Gauge	6Y5-8350F-B0-00
1	Fuel Flow Sensor Harness, 8.0m	6Y5-83553-F1-00
1	Fuel Flow Sensor	6Y5-85752-02-00
2	Screw	90158-06003-00
1	Wire Extension	703-82531-00-00
1	Wire Lead	6Y5-82117-00-00
2	Clamp	90465-10098-00

*For twin engines add one (1) 6Y5-85752-02-00

(Most installations will require additional parts, see section 2 for additional rigging information)

HelmMaster® Main Station Kits

HelmMaster® Kits contain serialized components and can only be ordered through Unit Sales, 1-800-628-9006.

Twin Engine Main Station Kit: HM-H2MD

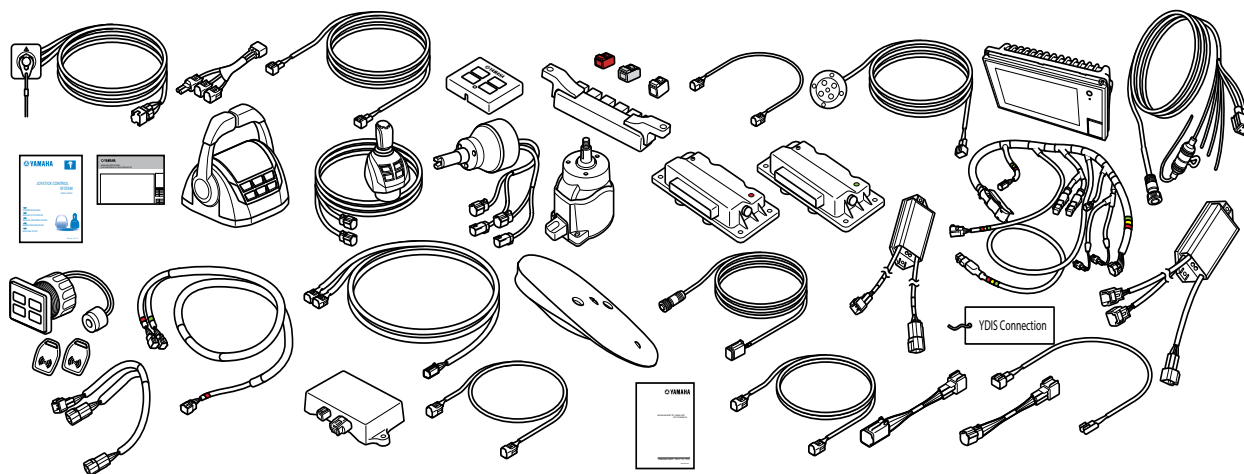

HM-H2MD Kit Includes:

No.	Description	Qty	Part Number	Serialized	No.	Description	Qty	Part Number	Serialized
1	Remote Control Assy	1	6ES482070300	Y	18	Resistor Harness	1	6ES827180000	N
2	Joystick Assy W/Sp	1	6ES482A01100	Y	19	Rem Cont-Hub Harne	1	6ES835536000	N
3	Helm Unit Assy	1	6ES615A00000	Y	20	L.e.d Ass'y	2	6ES837200100	N
4	EKS Assembly	1	6ES825100200	Y	21	Prop. Light Interf	1	6ES8A2D00000	N
5	Pcu For Twin, Port	1	6ES855901000	Y	22	Gps Gateway	1	6ES8A2D01000	N
6	Pcu For Twin, Stbd	1	6ES855902000	Y	23	Manual	1	6X62818R0000	N
7	Gps Antenna	1	6ES881070000	Y	24	Engine Stop Switch	1	6X6825709000	N
8	6Yd Touch Panel Ba	1	6YD837100100	Y	25	Multi Hub Assy	2	6Y8819200100	N
9	Manual	1	6ES2819KA000	N	26	2Ft Pigtail Bus	3	6Y8825211100	N
10	Manual	1	6ES2819UE400	N	27	12Ft Pigtail Bus	1	6Y8825215100	N
11	Tilt Helm Unit	1	6ES6154A1000	N	28	1Ft Main Bus	1	6Y8825530100	N
12	Eks Cover For Twin	1	6ES825680000	N	29	Cap 1 (2Pin)	2	6Y8825820100	N
13	Pcu Harness	2	6ES8258A0100	N	30	Cap 1 (4Pin)	4	6Y8825821100	N
14	Lanyard Harness 2P	2	6ES8258A2000	N	31	Adapter,6",Pigtal	1	6Y9835534000	N
15	Lanyard Harness 6P	1	6ES8258A3100	N	32	Adaptr,6",Nmea 200	1	6Y9835535000	N
16	Eks Harness For Tw	1	6ES8258A4000	N	33	Wire, Lead, Power,	1	6YD835530000	N
17	Prop. Light Interf	1	6ES82590C000	N					

Rigging Components

Triple Engine Main Station Kit: HM-H3MD

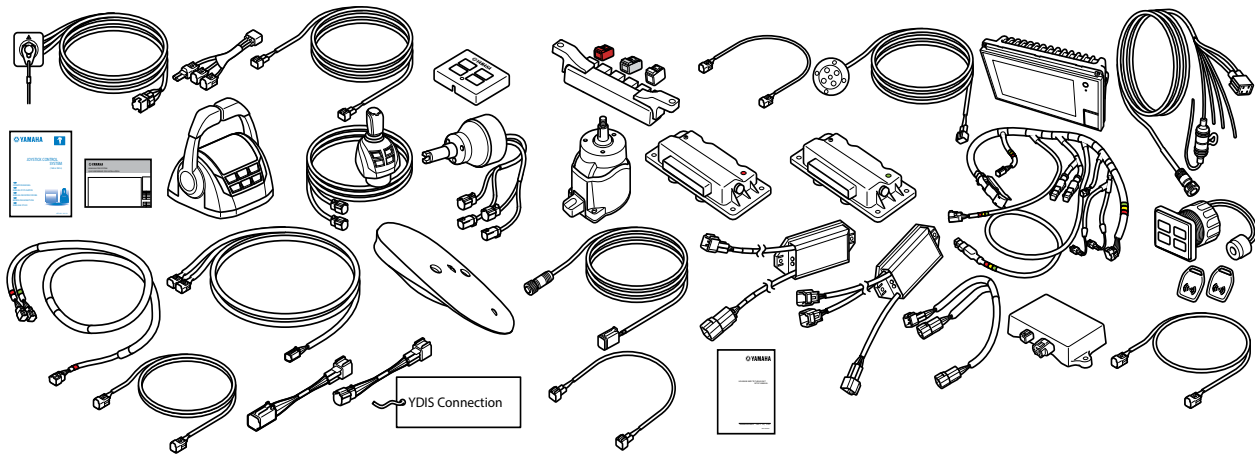

HM-H3MD Kit Includes:

No.	Description	Qty	Part Number	Serialized	No.	Description	Qty	Part Number	Serialized
1	Remote Control Assy	1	6ES482070300	Y	23	Helm T Harness For	2	6ES825900000	N
2	Joystick Assy W/Sp	1	6ES482A01100	Y	24	Center Hcu Harness	1	6ES825902000	N
3	Helm Unit Assy	1	6ES615A00000	Y	25	Helm Adaptr Harnes	2	6ES82590A000	N
4	EKS Assembly	1	6ES825100200	Y	26	Prop. Light Interf	1	6ES82590C000	N
5	Eks Assy, Without	1	6ES825101200	Y	27	Resistor Harness	1	6ES827180000	N
6	Center Hcu	1	6ES855900200	Y	28	Rem Cont-Hub Harnes	1	6ES835537100	N
7	Pcu For Triple, Po	1	6ES855903000	Y	29	L.e.d Ass'y	2	6ES837200100	N
8	Pcu For Triple, St	1	6ES855904000	Y	30	Prop. Light Interf	1	6ES8A2D00000	N
9	Pcu For Triple, Ce	1	6ES855905000	Y	31	Gps Gateway	1	6ES8A2D01000	N
10	Gps Antenna	1	6ES881070000	Y	32	Manual	1	6X62818R0000	N
11	Digital Communicat	1	6X88A2600000	Y	33	Engine Stop Switch	1	6X6825709000	N
12	6Yd Touch Panel Ba	1	6YD837100100	Y	34	Manual	1	6X82819KE000	N
13	Manual	1	6ES2819KE400	N	35	Multi Hub Assy	2	6Y8819200100	N
14	Manual	1	6ES2819UE400	N	36	2Ft Pigtail Bus	3	6Y8825211100	N
15	Manual	1	6ES2819UY400	N	37	6Ft Pigtail Bus	1	6Y8825213100	N
16	Tilt Helm Unit	1	6ES6154A1000	N	38	12Ft Pigtail Bus	1	6Y8825215100	N
17	Scu Link Cable	1	6ES811151000	N	39	1Ft Main Bus	1	6Y8825530100	N
18	Eks Cover For Trip	1	6ES825681000	N	40	Cap 1 (2Pin)	2	6Y8825820100	N
19	Pcu Harness	3	6ES8258A0100	N	41	Cap 1 (4Pin)	4	6Y8825821100	N
20	Lanyard Harness 2P	3	6ES8258A2000	N	42	Adapter,6",Pigtal	1	6Y9835534000	N
21	Lanyard Harness 6P	1	6ES8258A3100	N	43	Adaptr,6",Nmea 200	1	6Y9835535000	N
22	Eks Harness For Tr	1	6ES8258A5100	N	44	Wire, Lead, Power,	1	6YD835530000	N

Quad Engine Main Station Kit: HM-H4MD

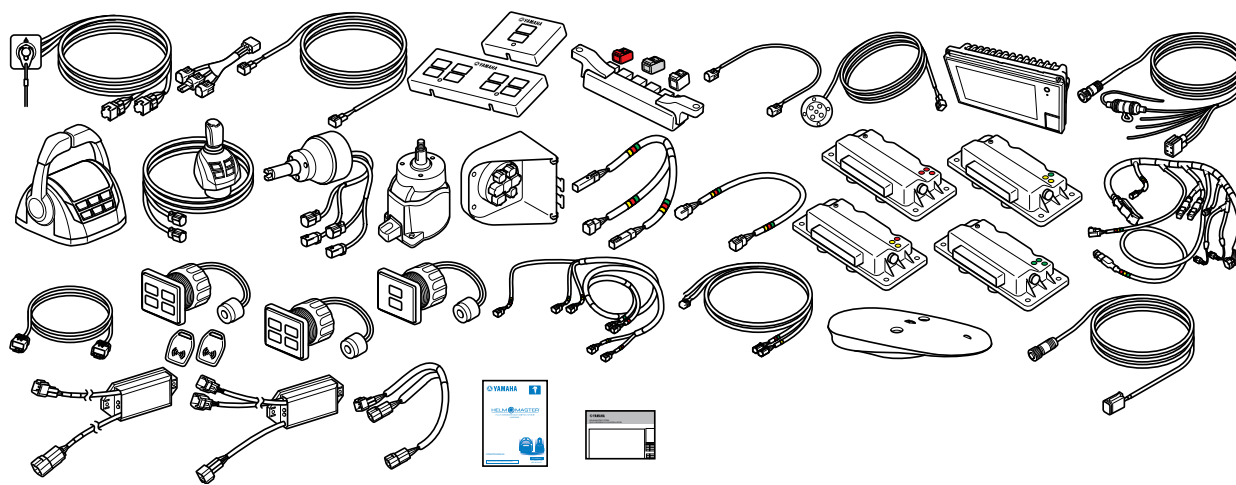

HM-H4MD Kit Includes:

No.	Description	Qty	Part Number	Serialized	No.	Description	Qty	Part Number	Serialized
1	Remote Control Assy	1	6ES482070300	Y	22	Lanyard Harness 2P	4	6ES8258A2000	N
2	Joystick Assy W/Sp	1	6ES482A01100	Y	23	Lanyard Harness 6P	2	6ES8258A3100	N
3	Helm Unit Assy	1	6ES615A00000	Y	24	Eks Harness For Qu	1	6ES8258A6000	N
4	EKS Assembly	1	6ES825100200	Y	25	Helm T Harness For	2	6ES825900000	N
5	Eks Assy, Without	1	6ES825101200	Y	26	Helm Adaptr Harnes	2	6ES82590A000	N
6	Main Switch Assy	1	6ES825102200	Y	27	Prop. Light Interf	1	6ES82590C000	N
7	Center Hcu	1	6ES855900200	Y	28	Resistor Harness	1	6ES827180000	N
8	Pcu For Quad, Port	1	6ES855906000	Y	29	Rem Cont-Hub Harne	1	6ES835537100	N
9	Pcu For Quad, Stbd	1	6ES855907000	Y	30	L.e.d Ass'y	2	6ES837200100	N
10	Pcu For Quad, Ptc	1	6ES855908000	Y	31	Prop. Light Interf	1	6ES8A2D00000	N
11	Pcu For Quad, Sbc	1	6ES855909000	Y	32	Gps Gateway	1	6ES8A2D01000	N
12	Gps Antenna	1	6ES881070000	Y	33	Manual	1	6X62818R0000	N
13	6Yd Touch Panel Ba	1	6YD837100100	Y	34	Multi Hub Assy	2	6Y8819200100	N
14	Manual	1	6ES2819KA000	N	35	2Ft Pigtail Bus	3	6Y8825211100	N
15	Manual	1	6ES2819VE300	N	36	12Ft Pigtail Bus	1	6Y8825215100	N
16	Tilt Helm Unit	1	6ES6154A1000	N	37	1Ft Main Bus	1	6Y8825530100	N
17	Scu Link Cable	1	6ES811151000	N	38	Cap 1 (2Pin)	2	6Y8825820100	N
18	Eks Cover For Quad	1	6ES825682000	N	39	Cap 1 (4Pin)	4	6Y8825821100	N
19	Eks Cover For Quad	1	6ES825683000	N	40	Adapter,6",Pigtal	1	6Y9835534000	N
20	Engine Stop Switch	1	6ES825700000	N	41	Adaptr,6",Nmea 200	1	6Y9835535000	N
21	Pcu Harness	4	6ES8258A0100	N	42	Wire, Lead, Power,	1	6YD835530000	N

HelmMaster® 2nd Station Kits

HelmMaster® Kits contain serialized components and can only be ordered through Unit Sales, 1-800-628-9006.

Twin Engine Second Station Kit: HM-H2SD

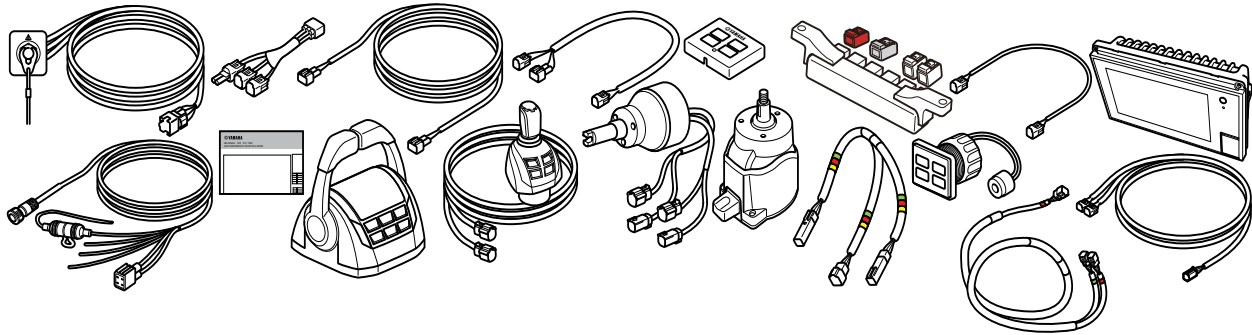

HM-H2SD Kit Includes:

No.	Description	Qty	Part Number	Serialized	No.	Description	Qty	Part Number	Serialized
1	Remote Control Assy	1	6ES482070300	Y	11	Eks Harness For Tw	1	6ES8258A4000	N
2	Joystick Assy W/Sp	1	6ES482A01100	Y	12	Lanyard Harness 2N	2	6ES8258A7000	N
3	Helm Unit Assy	1	6ES615A00000	Y	13	T Harness, 2Nd Sta	2	6ES8258A8000	N
4	Eks Assy, Without	1	6ES825101200	Y	14	Rem Cont-Hub Harne	1	6ES835536000	N
5	6Yd Touch Panel Ba	1	6YD837100100	Y	15	Engine Stop Switch	1	6X6825709000	N
6	Manual	1	6ES2819KE400	N	16	Multi Hub Assy	1	6Y8819200100	N
7	Tilt Helm Unit	1	6ES6154A1000	N	17	2Ft Pigtail Bus	1	6Y8825211100	N
8	Eks Cover For Twin	1	6ES825680000	N	18	Cap 1 (2Pin)	1	6Y8825820100	N
9	Lanyard Harness 2P	2	6ES8258A2000	N	19	Cap 1 (4Pin)	2	6Y8825821100	N
10	Lanyard Harness 6P	1	6ES8258A3100	N	20	Wire, Lead, Power,	1	6YD835530000	N

Triple Engine Second Station Kit: HM-H3SD

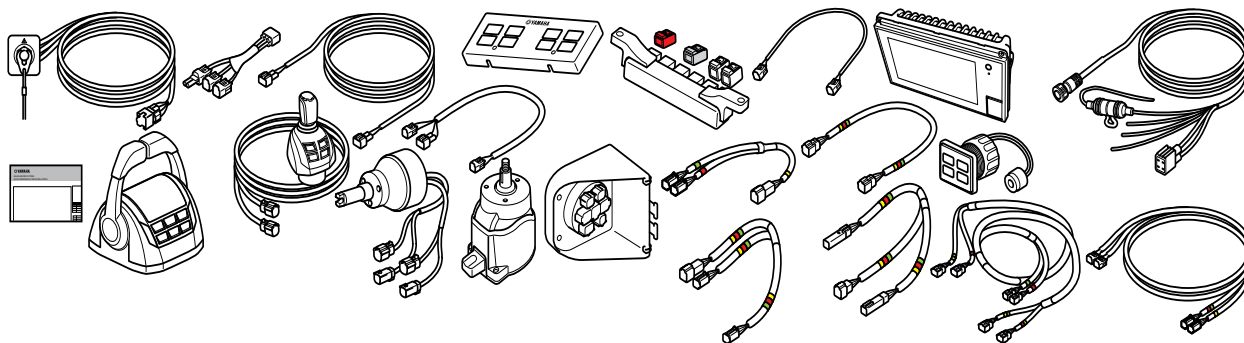

HM-H3SD Kit Includes:

No.	Description	Qty	Part Number	Serialized	No.	Description	Qty	Part Number	Serialized
1	Eks Assy, Without	1	6ES825101200	Y	13	Eks Harness For Tr	1	6ES8258A5100	N
2	Eks Assy, Without	1	6ES825101200	Y	14	Lanyard Harness 2N	3	6ES8258A7000	N
3	Remote Control Asy	1	6ES482070200	Y	15	T Harness, 2Nd Sta	3	6ES8258A8000	N
4	Joystick Assy W/Sp	1	6ES482A01000	Y	16	Helm T Harness For	2	6ES825900000	N
5	Helm Unit Assy	1	6ES615A00000	Y	17	Center Hcu Harness	1	6ES825902000	N
6	Center Hcu	1	6ES855900200	Y	18	Helm Adaptr Harnes	2	6ES82590A000	N
7	6Yd Touch Panel Ba	1	6YD837100100	N	19	Rem Cont-Hub Harne	1	6ES835537100	N
8	Manual	1	6ES2819K1000	N	20	Engine Stop Switch	1	6X6825709000	N
9	Tilt Helm Unit	1	6ES6154A1000	N	21	Multi Hub Assy	1	6Y8819200100	N
10	Eks Cover For Trip	1	6ES825681000	N	22	2Ft Pigtail Bus	1	6Y8825211100	N
11	Lanyard Harness 2P	3	6ES8258A2000	N	23	Cap 1 (2Pin)	1	6Y8825820100	N
12	Lanyard Harness 6P	1	6ES8258A3100	N	24	Cap 1 (4Pin)	2	6Y8825821100	N

Rigging Components

General Information

Rigging Estimate Guide (Diagrams)

Rigging Components

Electrical Components

Engine Accessories

Propellers

Maintenance Items

Oils & Lubes

Detailing & Trailer Supplies

Accessories & Apparel

Generators & Accessories

Quad Engine Second Station Kit: HM-H4SD

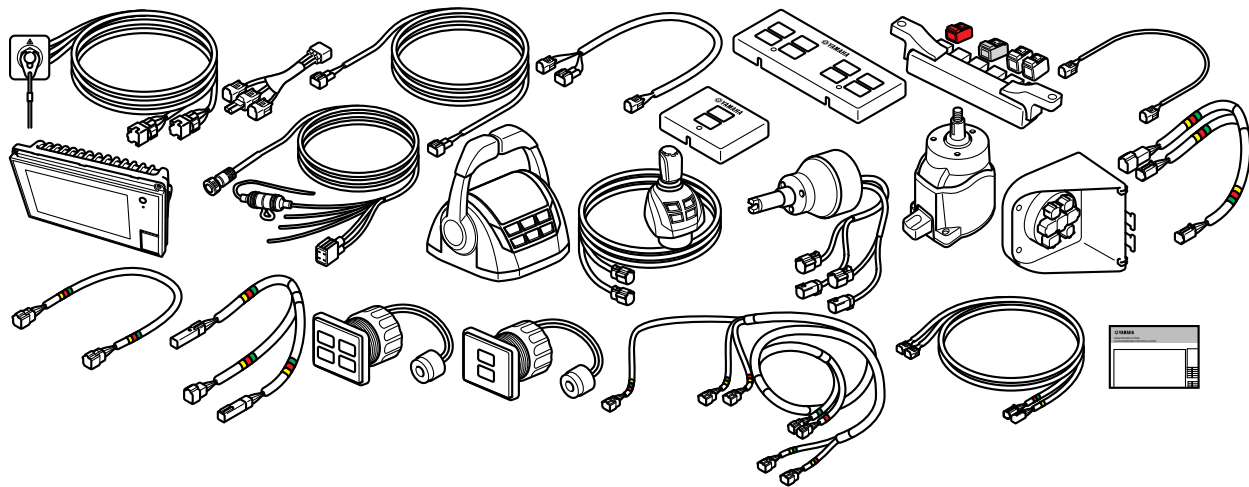

HM-H4SD Kit Includes:

No.	Description	Qty	Part Number	Serialized	No.	Description	Qty	Part Number	Serialized
1	Remote Control Assy	1	6ES482070300	Y	14	Lanyard Harness 6P	2	6ES8258A3100	N
2	Joystick Assy W/Sp	1	6ES482A01100	Y	15	Eks Harness For Qu	1	6ES8258A6000	N
3	Helm Unit Assy	1	6ES615A00000	Y	16	Lanyard Harness 2N	4	6ES8258A7000	N
4	Eks Assy, Without	1	6ES825101200	Y	17	T Harness, 2Nd Sta	4	6ES8258A8000	N
5	Main Switch Assy	1	6ES825102200	Y	18	Helm T Harness For	2	6ES825900000	N
6	Center Hcu	1	6ES855900200	Y	19	Helm Adaptr Harnes	2	6ES82590A000	N
7	6Yd Touch Panel Ba	1	6YD837100100	Y	20	Rem Cont-Hub Harnes	1	6ES835537100	N
8	Manual	1	6ES2819KL100	N	21	Multi Hub Assy	1	6Y8819200100	N
9	Tilt Helm Unit	1	6ES6154A1000	N	22	2Ft Pigtail Bus	1	6Y8825211100	N
10	Eks Cover For Quad	1	6ES825682000	N	23	Cap 1 (2Pin)	1	6Y8825820100	N
11	Eks Cover For Quad	1	6ES825683000	N	24	Cap 1 (4Pin)	2	6Y8825821100	N
12	Engine Stop Switch	1	6ES825700000	N	25	Wire, Lead, Power,	1	6YD835530000	N
13	Lanyard Harness 2P	4	6ES8258A2000	N					

HelmMaster® Steering Kits

HelmMaster® Kits contain serialized components and can only be ordered through Unit Sales, 1-800-628-9006.

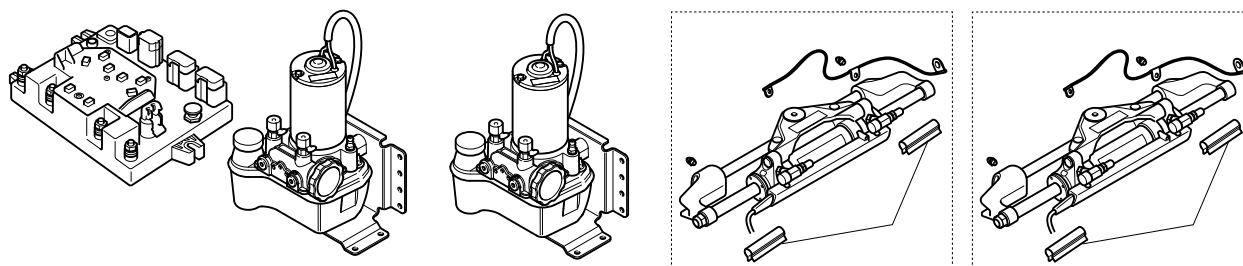

Twin Engine Steering Kit

HM-S2A Kit Includes:

Description	Qty	Part Number	Serialized	Description	Qty	Part Number	Serialized
SCU	1	6ES-859A0-01	Y	Steering cylinder assembly	2	6ES-42401-03	Y
Steering pump assembly	1	6ES-7611A-02	Y	Steering lock clips	1	6ES-23326-00	N

Triple Engine Steering Kit

HM-S3A Kit Includes:

Description	Qty	Part Number	Serialized	Description	Qty	Part Number	Serialized
SCU	2	6ES-859A0-01	Y	Steering cylinder assembly	3	6ES-42401-03	Y
Steering pump assembly	3	6ES-7611A-02	Y	Steering lock clips	3	6ES-23326-00	N

Quad Engine Steering Kit

HM-S4A Kit Includes:

Description	Qty	Part Number	Serialized	Description	Qty	Part Number	Serialized
SCU	2	6ES-859A0-01	Y	Steering cylinder assembly	4	6ES-42401-03	Y
Steering pump assembly	4	6ES-7611A-02	Y	Steering lock clips	4	6ES-23326-00	N

DEC Controls *(Must be Ordered Through Sales)*

Command Link Plus® Control Boxes

Yamaha's line of Command Link Plus® Digital Electronic Controls are perfect for new V6 Offshore outboard models, as well as the new F350 with Command Link Plus compatibility. With the same mounting dimensions as Command Link controls, they all offer virtually effortless throttle and shift functions, highly-polished chrome handles, and a built-in redundancy system for added reliability. Like all Command Link® DEC's, a separate Electronic Control Unit (ECU) is included for each outboard – a huge advantage over some competitive models. And thanks to 'plug-and-play' convenience, adding a second station control is a breeze. Additionally, all multiple engine Command Link DEC's feature automatic engine RPM synchronization. The Quad engine control box synchronizes the port and port center engines together and the starboard and starboard center engines together. All main station Command Link Plus DEC binnacle control boxes offer second station compatibility.

DEC Control Boxes **MUST** be ordered through outboard sales.



Single Engine Flush Control
CL-1FMA
Second Station Control
CL-1FSA



Single Engine Binnacle Control
CL-1MC
Second Station Control
CL-1SC



Twin Engine Binnacle Control
CL-2MC
Second Station Control
CL-2SC



Triple Engine Binnacle Control
CL-3MC
Second Station Control
CL-3SC



Quad Engine Binnacle Control
CL-4MC
Second Station Control
CL-4SC



DEC Control Box Spacers
Twin / Triple / Quad Spacer
MAR-SHIM8-66-00
Single Control Spacer
MAR-SHIM8-65-00

DEC Control Boxes **MUST** be ordered through outboard sales.

Mechanical Controls

Mechanical Control Boxes

Classic style and function combined with Yamaha's high standards. The perfect line up of control boxes for mechanical controlled engines.



704 Premium Control Boxes

Top-mount binnacle control with a sleek, rounded look that is sure to please today's boater. The 704 allows for effortless, one-hand operation of the throttle and shift of an outboard. Intuitive designs place a thumb-operated, engine trim/tilt switch comfortably on the handle, and feature easily accessible neutral warm-up controls and externally adjustable throttle friction. Stylish chrome finish.

Single Engine: 704-48205-R0-00

Twin Engine: 704-48207-R0-00



Triple Binnacle Control Box

This uniquely designed triple control box allows for one hand operation for easier maneuverability. The unique triple control box has a built-in water drain tube for added reliability & long term durability. Easy access cable connection location for faster & easier rigging.

6X5-48207-03-00

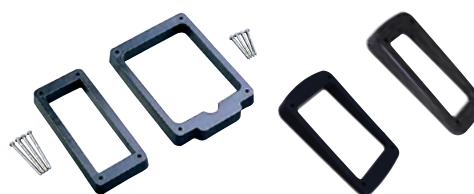

Mechanical Binnacle Spacers

Designed to raise the 704 Binnacle Control to provide more clearance for the lever in idle and full-throttle positions.

Standard Single Flat Spacer: 704-48293-00-00

Premium Single Flat Spacer: 704-48293-20-00

Premium Single Angled Spacer: MAR-SHIM8-63-00

Premium Twin Flat Spacer: 704-48293-30-00

Premium Twin Angled Spacer: MAR-SHIM8-64-00



Flush Mount Control Boxes

Includes thumb-operated trim/tilt switch, neutral switch and push-button neutral warm-up. Fits most single engine applications and they're perfect for a bass boat.

Flush Mount Control Box:

Right Side Mount* (w/ stop switch) - **6X3-48206-10-00**

Left Side Mount (w/o stop switch) - **6X3-48206-21-00**

* Requires main switch duplex connector, 6X3-8257B-01-00

Mechanical 703 Side Mount Control Boxes

Designed for use with electric start Yamaha outboards. Features include:

Convenient easy-to-use fast-idle lever for fast warm-up. Key switch for added security Forward/ reverse lever. 703 control boxes include a key switch, stop lanyard, and 16 foot main harness.

Push to Open, 10 Pin Harness: 703-48207-22-00

Pull to Open w/ Choke, 7 Pin Harness: 703-48230-21-00

Trim switch cover: 703-48224-00-00

Replacement 10 Pin Harness: 688-8258A-20-00

Replacement 7 Pin Harness: 688-82586-21-00



Pull to Open

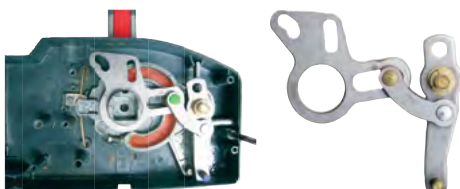

Push to Open



Side Mount Throttle Conversion

Although the control boxes available may not meet your throttle style, the parts below can be ordered to convert a side mount box to the throttle style you need.

703 Push to Open Conversion: 703-48261-01-00

703 Pull to Open Conversion: 703-48261-11-00

701 Push to Open Conversion: 701-48261-20-00

701 Pull to Open Conversion: 701-48261-00-00

Mechanical 701 Side Mount Control Boxes

Designed specifically for most manual start Yamaha outboards. A single forward/reverse control lever and a separate fast idle lever provide easy operation.

Pull to Open Throttle:

703-48260-20-00

Port Side Mount, Pull to Open Throttle:

703-48260-20-00

Tiller Handles

Yamaha's Multifunction Tiller Handle combines ergonomic design, smooth shifting, fingertip controls and an extended throttle handle for virtually effortless maneuverability. Add to that Yamaha's exclusive Variable Trolling RPM Switch (VTS® F40LA through F90 models only) and a 90° throttle rotation angle, and steering is not only easy, it's more comfortable too. It's easy to see why our Multifunction Tiller Handle won an IBEX® Innovation Award in 2005.

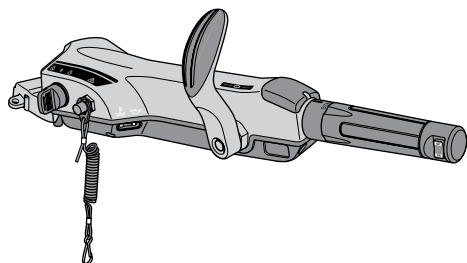

F25 Complete Tiller Handle Assembly (~2016)
Includes everything required to mount a tiller handle on F25 Outboard produced until 2016.

6X4-42103-0D-00



Tiller Handle Main Assembly

The tiller handle main assembly requires the use of a fitting kit below to mount to a Yamaha Outboard.

6X4-42103-58-00



Tiller Handle Fitting Kits

The fitting kits are used along with the Main Handle Assembly. They typically include the wire harness and mounting hardware.

2-Stroke Fitting Kits

Application	Part Number
40, 50	6X4-42102-63-00
60, 70	6X4-42102-52-00
80, 90	6X4-42102-42-00

4 Stroke Fitting Kits

Application	Part Number
F20B	6X4-42102-K0-00
F25C / T25C	6X4-42102-E0-00
F40B (Carburated)	6X4-42102-32-00
F30 / F40LA (EFI)	6X4-42102-71-00
F50, F60, F70	6X4-42102-23-00
F75, F90A	6X4-42102-12-00
F90B/VF90	6X4-42102-J1-00
F115 / VF115	6X4-42102-02-00
F115B / VF115B	6X4-42102-H0-00

Controls Cables

Premier II™ Control Cables

Yamaha is pleased to offer Premier II cables. They offer an ultra-low-friction splined inner core. The design allows tighter tolerances resulting in reduced end play. We highly recommend the use of Premier II cables for boats with several applications and long cable lengths, on dual-station boats, and on any boat for unrivaled smoothness. (cables do not include cable ends)

Cable Length	Individual Part Number	10 Pack Part Number
4 Ft.	MAR-CABLE-04-SC	N/A
6 Ft.	MAR-CABLE-06-SC	MAR-CABLE-06-BK
7 Ft.	MAR-CABLE-07-SC	MAR-CABLE-07-BK
8 Ft.	MAR-CABLE-08-SC	MAR-CABLE-08-BK
9 Ft.	MAR-CABLE-09-SC	MAR-CABLE-09-BK
10 Ft.	MAR-CABLE-10-SC	MAR-CABLE-10-BK
11 Ft.	MAR-CABLE-11-SC	MAR-CABLE-11-BK
12 Ft.	MAR-CABLE-12-SC	MAR-CABLE-12-BK
13 Ft.	MAR-CABLE-13-SC	MAR-CABLE-13-BK
14 Ft.	MAR-CABLE-14-SC	MAR-CABLE-14-BK
15 Ft.	MAR-CABLE-15-SC	MAR-CABLE-15-BK
16 Ft.	MAR-CABLE-16-SC	MAR-CABLE-16-BK
17 Ft.	MAR-CABLE-17-SC	MAR-CABLE-17-BK
18 Ft.	MAR-CABLE-18-SC	MAR-CABLE-18-BK
19 Ft.	MAR-CABLE-19-SC	MAR-CABLE-19-BK
20 Ft.	MAR-CABLE-20-SC	MAR-CABLE-20-BK
21 Ft.	MAR-CABLE-21-SC	MAR-CABLE-21-BK
22 Ft.	MAR-CABLE-22-SC	MAR-CABLE-22-BK
23 Ft.	MAR-CABLE-23-SC	MAR-CABLE-23-BK
24 Ft.	MAR-CABLE-24-SC	MAR-CABLE-24-BK
25 Ft.	MAR-CABLE-25-SC	MAR-CABLE-25-BK
26 Ft.	MAR-CABLE-26-SC	MAR-CABLE-26-BK
27 Ft.	MAR-CABLE-27-SC	MAR-CABLE-27-BK
28 Ft.	MAR-CABLE-28-SC	MAR-CABLE-28-BK
29 Ft.	MAR-CABLE-29-SC	MAR-CABLE-29-BK
30 Ft.	MAR-CABLE-30-SC	MAR-CABLE-30-BK
32 Ft.	MAR-CABLE-32-SC	N/A
34 Ft.	MAR-CABLE-34-SC	N/A
36 Ft.	MAR-CABLE-36-SC	N/A
38 Ft.	MAR-CABLE-38-SC	N/A
40 Ft.	MAR-CABLE-40-SC	N/A

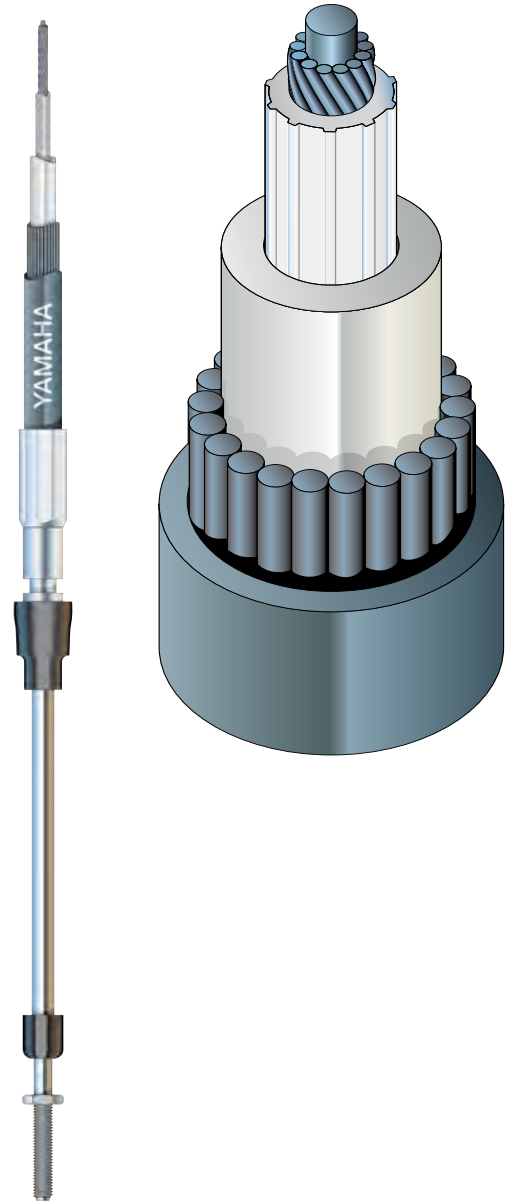

General Information

Rigging Estimate Guide (Diagrams)

Rigging Components

Electrical Components

Engine Accessories

Propellers

Maintenance Items

Oils & Lubes

Detailing & Trailer Supplies

Accessories & Apparel

Generators & Accessories

Throttle and Shift Cable Ends
 From time to time control cables need new ends. The following list provides a guide to selecting the correct one. The most current information can always be found using Parts Manager Pro™ Online through YMBS.



Control Cable Ends
Shift and Throttle Ends: 703-48345-01-00
Fastener for Cable Ends: 93430-06024-00

Engine Control Cable Ends

Four Stroke

MODEL	THROTTLE	SHIFT	FASTENER
F6, F/T8, F/T9.9(05~)	6FM-48344-00-00	6FM-48344-00-00	90468-18008-00 (Clip)
F/T9.9(~04)	6G8-26363-00-00	6G8-26363-00-00	6G8-26364-00-00 (Slide)
F15, F20, F/T25	6FM-48344-00-00	6FM-48344-00-00	90468-18008-00 (Clip)
F20C, F25C, T25C	6FM-48344-00-00	6FM-48344-00-00	90468-18008-00 (Clip)
F30, F40(06-08)	67C-48344-10-00	67C-48344-10-00	90468-18008-00 (Clip)
F40(99), F/T50(~04)	6G8-26363-00-00	6G8-26363-00-00	90468-18008-00 (Clip)
F/T50(05~), F/T60(02~), F70(11~)	69W-48344-00-00	69W-48344-00-00	90468-18008-00 (Clip)
F75(~16), F80, F90(~16), F/L115(~14)	6FM-48344-00-00	6FM-48344-00-00	90468-18008-00 (Clip)
F90B, F/L115(14~), F/L150~300	6E5-48344-00-00	6E5-48344-00-00	90468-18008-00 (Clip)
VF90, VF/L115 ~ 250	6E5-48344-00-00	6E5-48344-00-00	90468-18008-00 (Clip)

Two Stroke

MODEL	THROTTLE	SHIFT	FASTENER
9.9(96~), 15(96~)	6FM-48344-00-00	6FM-48344-00-00	90468-18008-00 (Clip)
6, 8, 9.9(~95), 15(~95)	682-48340-50-00*	682-48330-50-00*	See Note
25 2cyl., 25/30 3cyl.	6G8-26363-00-00	6G8-26363-00-00	6G8-26364-00-00 (Slide)
C25, C30, C40 2cyl.(89~)	648-48340-50-00*	648-48330-50-00*	See Note
40/50 (~94)	6H4-48344-00-00 (Elec) 6FM-48344-00-00 (Man)	6H4-48344-00-00	90468-18008-00 (Clip)
40/50 (95~)	6H4-48344-00-00 63D-48344-00-00(Man)	6FM-48344-00-00(Elec)	90468-18008-00 (Clip)
C403cyl.(97~02), C50	6H4-48344-00-00	6FM-48344-00-00	90468-18008-00 (Clip)
P50	6H4-48344-00-00	6H4-48344-00-00	90468-18008-00 (Clip)
P60 (~95)	6FM-48344-00-00	6FM-48344-00-00	90468-18008-00 (Clip)
60, P60(96~), C60, C70, 70(96~)	6H3-48344-00-00	6FM-48344-00-00	90468-18008-00 (Clip)
C55, C75, P75, C80, C85	6FM-48344-00-00	6FM-48344-00-00	90468-18008-00 (Clip)
70(~95)	6FM-48344-00-00	6FM-48344-00-00	90468-18008-00 (Clip)
90, B90, C90	6FM-48344-00-00	6FM-48344-00-00	90468-18008-00 (Clip)
S115~130(96~97) 115~200 (84~95)	6E5-48344-00-00	6E5-48344-00-00	90185-06062-00 (Nut)
115~130 (96~)	6E5-48344-00-00	6E5-48344-00-00	90185-06M07-00 (Nut) 90468-18008-00 (Clip)
D/DX 150	6E5-48344-00-00	6E5-48344-00-00	90468-18008-00 (Clip)
Z/LZ/VZ 150~300	6E5-48344-00-00	6E5-48344-00-00	90468-18008-00 (Clip)
S, L, SX, LX 150~250	6E5-48344-00-00	6E5-48344-00-00	90468-18008-00 (Clip)
150~200(96~), 225, 250	6E5-48344-00-00	6E5-48344-00-00	90468-18008-00 (Clip)
V6Spec/V6Excel	6E5-48344-00-00	6E5-48344-00-00	90468-18008-00 (Clip)
V/VX/150~250	6E5-48344-00-00	6E5-48344-00-00	90468-18008-00 (Clip)

*Includes cable end, cable hook, spring, pin, and washer

Command Link Plus® Main Switches



Single Engine Main Station Switch

Yamaha's Command Link Plus key panels offer the latest in technology and durability, with a new ergonomic key design and new functionality. The single engine switch is the only Command Link Plus key switch to use the conventional key switch connector. Three position switch.

6X6-82570-33-00



Twin Engines Main Station Switch Kit

The Twin Engine Main Switch Kit offers the latest in technology energizing the ignition system of multiple outboards with only one key. Optional "All Start" switch can be added for additional convenience. (Kit includes Main Switch Panel 6X6-82570-40-00 and Twin Start / Stop Panel 6X6-82570-60-00.)

6X6-W0035-50-00



Triple Engines Main Station Switch Kit

The Triple Engine Main Switch Kit offers the latest in technology energizing the ignition system of multiple outboards with only one key. Optional "All Start" switch can be added for additional convenience. (Kit includes Main Switch Panel 6X6-82570-50-00 and Triple Start / Stop Panel 6X6-82570-70-00.)

6X6-W0035-60-00



Quad Engines Main Station Switch Kit

Yamaha's Command Link Plus key panels offer the latest in technology and durability, with a new ergonomic key design and new functionality. Four keyed alike switches help keep things simple and straight forward. (Kit includes Key Switch Set 6X6-82570-M2-00, Lanyard Panel Assembly 6X6-82570-V0-00, Key Switch Harness 6X6-8258A-L0-00, and Stop Switch Harness 6X6-8258A-U0-00)

MAR-QUAD1-KT-00



All Start / Stop Switch

Allows twin or triple engines to be started successively (to prevent high amperage draw on the starting battery) or stopped simultaneously with the touch of a single button. For convenience and protection, engines cannot be started while running. The All Start / Stop switch can be installed on the main station of triple or twin engine installations only.

6X6-82570-C0-00



Single Engine Second Station Switch Kit

Stylish and functional, Command Link Plus® second station switch kits allow the transfer of control between stations or starting and stopping the engine with the push of a button. (Kit includes two station selector switches 6X6-82570-B0-00, Lanyard Panel Assembly 6X6-82570-90-00, and Start / Stop Switch 6X6-82570-80-00)

6X6-W0035-70-00



Twin Engines Second Station Switch Kit

Stylish and functional, Command Link Plus® second station switch kits allow the transfer of control between stations or starting and stopping the engine with the push of a button. (Kit includes two station selector switches 6X6-82570-B0-00, Lanyard Panel Assembly 6X6-82570-90-00, and Start / Stop Switch 6X6-82570-E0-00)

6X6-W0035-80-00



Triple Engines Second Station Switch Kit

Stylish and functional, Command Link Plus® second station switch kits allow the transfer of control between stations or starting and stopping the engine with the push of a button. (Kit includes two station selector switches 6X6-82570-B0-00, Lanyard Panel Assembly 6X6-82570-90-00, and Start / Stop Switch 6X6-82570-F0-00)

6X6-W0035-90-00



Quad Engines Second Station Switch Kit

Stylish and functional, Command Link Plus® second station switch kits allow the transfer of control between stations or starting and stopping the engine with the push of a button. (Kit includes two station selector switches 6X6-82570-L0-00, Lanyard Panel Assembly 6X6-82570-V0-00, Port Start / Stop Switch 6X6-82570-J0-00, and Starboard Start / Stop Switch 6X6-82570-K0-00)

MAR-QUAD2-KT-00

Command Link® and Conventional Main Station Switch Panels



Triple Engine Switch Panel

Designed exclusively for Yamaha's Command Link Integrated Marine Information System. Features interchangeable keys and a single engine stop lanyard for added convenience. Compact size maximizes dash space, simplifies installation. (Replacement Main Switch: 6X5-82510-02-00, Replacement Panel: 6X5-82571-00-00, Replacement Panel: 6X5-82571-00-00)

6X5-82570-02-00



Twin Engine Switch Panel

Push main switch to choke. With choke and engine warning buzzer. For use with conventional Yamaha rigging only. (Replacement Main Switch: 6K1-82510-07-00, Replacement Panel: 6K1-82571-02-00, Replacement Lanyard: 682-82556-00-00)

6K1-82570-13-00



Command Link® Twin Engine Switch Panel

Designed to work exclusively with Command Link. Interchangeable keys add convenience, and a single engine stop lanyard cuts clutter. Compact size maximizes dash space, simplifies installation. (Replacement Main Switch: 6Y8-82510-03-00, Replacement Panel: 6Y8-82571-01-00, Replacement Lanyard: 682-82556-00-00)

6Y8-82570-04-00



Single Engine Switch Panel

Push main switch to choke. With choke switch and engine warning buzzer. For use with either Command Link or conventional Yamaha rigging. (Replacement Main Switch: 704-82510-07-00, Replacement Panel: 704-82571-02-00, Replacement Lanyard: 682-82556-00-00)

704-82570-12-00



Single Engine Switch Panel

Includes multi-connector to main harness, connectors for instrument harness, and engine stop lanyard switch. With bullet connectors for generic engine stop lanyard switch. (Replacement Main Switch: 64D-82510-04-00, Replacement Panel: 64D-82571-00-00)

Standard connector: 64D-82570-05-00
With duplex connector: 6X3-8257B-01-00

Lanyard Panel

For use with duplex connector and main switch assembly. (Replacement Lanyard: 682-82556-00-00)

64D-82570-31-00



Single Engine Key Switch Assembly

Main switch and lanyard used in the 704 single engine switch panel, but with out the panel. Perfect for custom boat installations. (Replacement Main Switch: 704-82510-0A-00, Replacement Lanyard: 682-82556-00-00)

704-8257C-03-00



Tiller Handle Key Switch

For use with the 6X4 tiller handle.

6X4-82510-01-00

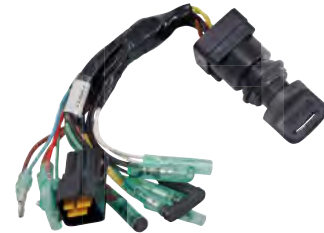

Single Engine Key Switch Assembly

With duplex connector for use with 6X3 Flush Side Control. (Replacement Main Switch: 64D-82510-04-00. If a panel is needed, use Single Main Switch on Panel 64D-82570-22-00.)

6X3-8257B-01-00



Lanyard Switch

An emergency stop switch without a panel. (Replacement Lanyard: 682-82556-00-00)

688-82575-02-00



General Information

Rigging Estimate Guide (Diagrams)

Rigging Components

Electrical Components

Engine Accessories

Propellers

Maintenance Items

Oils & Lubes

Detailing & Trailer Supplies

Accessories & Apparel

Generators & Accessories

Command Link® and Conventional Second Station Switch Panels



Single Engine Command Link® Second Station Switch Panel
Designed exclusively for Yamaha's Command Link® Integrated Marine Information System and the Synchro Control System. For use on second station only.

Command Link® Panel: 6X6-82570-01-00
Conventional Panel: 6X1-82570-02-00



Twin Engine Conventional Second Station Switch Panel
Designed exclusively for use with the Synchro Control System. For use on second station only.

Command Link® Panel: 6X6-82570-11-00
Conventional Panel: 6X1-82570-12-00



Triple Engine Command Link® Second Station Switch Panel
Designed exclusively for Yamaha's Command Link® Integrated Marine Information System. For use on second station only.

6X6-82570-20-00



Command Link® Station Selector Switch
Designed exclusively for Yamaha's Command Link® Integrated Marine Information System. This switch will not connect to a Command Link® Plus control box.

6X6-82570-A0-00



Command Link Plus® Station Selector Switch
Designed exclusively for Yamaha's Command Link Plus® Integrated Marine Information System. This switch will not connect to a Command Link® control box.

6X6-82570-B0-00

Replacement Keys and Caps

Replacement Keys and Key Caps

When a customer loses a key, Yamaha makes it easy for you to get them a new one.

If they have lost all their keys, just locate the key number off the main switch barrel.

700 Series Keys

Key	Part Number	Key	Part Number	Key	Part Number
721	90890-56004-00	732	90890-56008-00	750	90890-56012-00
727	90890-56005-00	733	90890-56009-00	751	90890-56013-00
730	90890-56006-00	741	90890-56010-00	752	90890-56014-00
731	90890-56007-00	747	90890-56011-00	753	90890-56015-00

300 Series Keys

Key	Part Number	Key	Part Number	Key	Part Number
371	90890-55868-00	378	90890-55875-00	385	90890-55882-00
372	90890-55869-00	379	90890-55876-00	386	90890-55883-00
373	90890-55870-00	380	90890-55877-00	387	90890-55884-00
374	90890-55871-00	381	90890-55878-00	388	90890-55885-00
375	90890-55872-00	382	90890-55879-00	389	90890-55886-00
376	90890-55873-00	383	90890-55880-00	390	90890-55887-00
377	90890-55874-00	384	90890-55881-00		

800 Series Keys

Key	Part Number	Key	Part Number	Key	Part Number
821	90890-56016-00	832	90890-56020-00	850	90890-56024-00
827	90890-56017-00	833	90890-56021-00	851	90890-56025-00
830	90890-56018-00	841	90890-56022-00	852	90890-56026-00
831	90890-56019-00	847	90890-56023-00	853	90890-56027-00

400 Series Keys

Key	Part Number	Key	Part Number	Key	Part Number
451	90890-55820-00	458	90890-55827-00	465	90890-55834-00
452	90890-55821-00	459	90890-55828-00	466	90890-55835-00
453	90890-55822-00	460	90890-55829-00	467	90890-55836-00
454	90890-55823-00	461	90890-55830-00	468	90890-55837-00
455	90890-55824-00	462	90890-55831-00	469	90890-55838-00
456	90890-55825-00	463	90890-55832-00	470	90890-55839-00
457	90890-55826-00	464	90890-55833-00		

Command Link®/Command Link Plus® Series Keys

Key	Part Number	Key	Part Number	Key	Part Number
457	6X6-82511-09-A1	832	6X6-82511-09-A5	853	6X6-82511-09-A9
462	6X6-82511-09-A2	833	6X6-82511-09-A6		
463	6X6-82511-09-A3	847	6X6-82511-09-A7		
827	6X6-82511-09-A4	852	6X6-82511-09-A8		

Yamaha Key Covers

Key covers are weather resistant and branded with the Yamaha name. Replacement keys come without a cover.

300 / 700 Series Key Cover: 703-82577-00-00

14mm Switch Cover for 300 / 700 Series Keys: 6K1-82532-00-00

400 / 800 Series Key Cover: 676-82577-01-00

15mm Switch Cover for 300 / 700 Series Keys: 703-82532-00-00



300/700 Series



400/800 Series

General Information

Rigging Estimate Guide (Diagrams)

Rigging Components

Electrical Components

Engine Accessories

Propellers

Maintenance Items

Oils & Lubes

Detailing & Trailer Supplies

Accessories & Apparel

Generators & Accessories



Description	Page
Helm Master Harnesses	4-1
XTO Offshore® V8 Harnesses	4-2
Command Link® and Command Link Plus® Harnesses	4-3
Command Link® and Command Link Plus® Accessories	4-6
Conventional Harnesses	4-9
Conventional Accessories	4-14
Charging, Starting, and Battery Cables	4-15
Switches and Indicators	4-17
Wire Connections and Circuit Protection	4-19

Helm Master® Harnesses

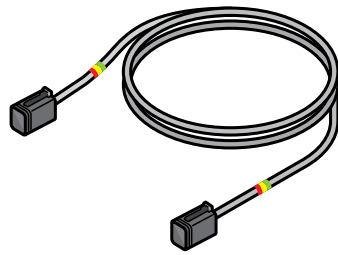

Helm Control Unit (HCU) to Power Control Unit (PCU) Harness

- 5 ft.- 6ES-82590-70-00**
- 10 ft.- 6ES-82590-30-00**
- 23 ft.- 6ES-82590-50-00**
- 36 ft.- 6ES-82590-10-00**

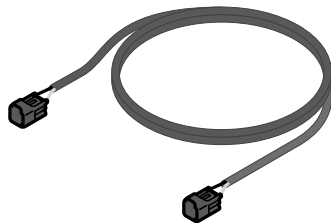

Steering Sensor Extension Harness

- 6 ft.- 6ES-8258A-90-00**
- 12 ft.- 6ES-8258A-A0-00**
- 18 ft.- 6ES-8258A-B0-00**

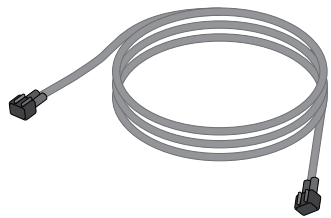

Prop Light Extension Harness

- 20 ft.- 6ES-PLEXT-20-00**
- 30 ft.- 6ES-PLEXT-30-00**
- 40 ft.- 6ES-PLEXT-40-00**

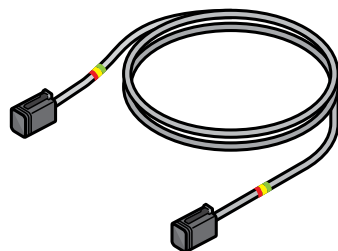

Steering Control Unit (SCU) to PCU Extension Harness

- 3.5 ft.- 6ES-8258A-C0-00**

XTO Offshore® V8 Harnesses

XTO Offshore® Single Engine Helm Harness

Main Station: **3 ft.- 6GR-8258A-00-00**
6 ft.- 6GR-8258A-40-00
2nd Station: **3 ft.- 6GR-8258A-20-00**



XTO Offshore® Multiple Engine Helm Harness

Main Station: **3 ft.- 6GR-8258A-10-00**
6 ft.- 6GR-8258A-50-00
2nd Station: **3 ft.- 6GR-8258A-30-00**



Steering Control Unit (SCU) Link Harness Port/Starboard

5 ft.- 6GR-81115-00-00
10 ft.- 6GR-81115-10-00



Steering Control Unit (SCU) Link Harness Center Engine(s)

5 ft.- 6GR-81115-20-00
10 ft.- 6GR-81115-30-00



Digital Communication Kit

6GR-HLDCM-KT-00



General Information

Rigging Estimate Guide (Diagrams)

Rigging Components

Electrical Components

Engine Accessories

Propellers

Maintenance Items

Oils & Lubes

Detailing & Trailer Supplies

Accessories & Apparel

Generators & Accessories

Command Link® and Command Link® Plus Harnesses



DEC (Digial Electronic Control) Main Harness

The DEC 16 pin main harness works for both Command Link® Plus (CLP) and the current Command Link® systems. The DEC main harness connects the engine to the main station control box. One per engine is required when rigging.

12 ft.- 6X6-8258A-50-00	26 ft.- 6X6-8258A-20-00
20 ft.- 6X6-8258A-00-00	33.5 ft.- 6X6-8258A-30-00
23 ft.- 6X6-8258A-10-00	39 ft.- 6X6-8258A-40-00



Main Bus Harness

The Main Bus Harness is used in Command Link® (CL) and Command Link Plus® systems. The harness has one 6 pin connection on each end and is used to connect multi hubs into the network.

1 ft.- 6Y8-82553-01-00	20 ft.- 6Y8-82553-21-00
10 ft.- 6Y8-82553-50-00	25 ft.- 6Y8-82553-31-00
15 ft.- 6Y8-82553-11-00	30 ft.- 6Y8-82553-41-00



Command Link® Main Bus Harness with Power Leads

For use with Command Link® systems. Combines the power harness and Main Bus harness to simplify rigging. 14 ft. in length

6Y8-82553-60-00



Pigtail Bus Harness

The Pigtail Harness is used in Command Link® and Command Link Plus® systems. The harness has one 4 pin connection on each end and is used to connect gauges and other items into the network.

1 ft.- 6Y8-82521-01-00	6 ft.- 6Y8-82521-31-00
2 ft.- 6Y8-82521-11-00	9 ft.- 6Y8-82521-41-00
3 ft.- 6Y8-82521-21-00	12 ft.- 6Y8-82521-51-00



Command Link® Pigtail Y Harness

For use with Command Link® systems. Allows two gauges to be connected to the Command Link® Main Bus with Power Leads with an In Line Hub.

6Y8-82521-80-00

8 ft. Power Lead Harness

The 8 ft. Power Lead Harness connects power from the key switch to the multi hub for gauges and other components. The harness is used in Command Link and Command Link Plus systems.

6Y8-83553-01-00



Multi-Hub Assembly

The Multi-Hub is used in both Command Link and Command Link Plus systems to allow devices to connect into the network with 1 power supply connector, 2 main BUS connectors, and 3 device connectors.

6Y8-81920-01-00



In-Line Hub Assembly

The In-Line hub is used in both Command Link and Command Link Plus systems. The hub works great with the Multisensor or in a simple Command Link installation. Connects a pig tale harness to a main bus harness.

6Y8-81920-11-00



Grey Main Bus Connection Cap with Resistor

During the installation and rigging process, the number of multi-hubs required may result in unused connector positions. One resistor cap is included with a multi-hub assembly.

6Y8-85371-01-00



Red Power 2 Pin Connection Cap

During the installation and rigging process, the number of multi-hubs required may result in unused connector positions. In most installations only one multi-hub will have a used power connection. The rest will require a protective cap.

6Y8-82582-01-00



White Pigtail 4 Pin Connection Cap

During the installation and rigging process, the number of multi-hubs required may result in unused connector positions. The 4 pin cap covers any unused device ports on the multi-hub.

6Y8-82582-11-00



General Information

Rigging Estimate Guide (Diagrams)

Rigging Components

Electrical Components

Engine Accessories

Propellers

Maintenance Items

Oils & Lubes

Detailing & Trailer Supplies

Accessories & Apparel

Generators & Accessories



Command Link Plus® Second Station Primary Harness

The CLP second station primary harness connects the main station control box with the second station control with the help of a secondary harness. The primary harness has one 6 pin connector, one 4 pin connector, and one 3 pin connector on each end. One second station primary harness is required per engine when rigging a second station. For use with CLP control boxes.

16 ft.- 6X6-8258A-G1-00
26 ft.- 6X6-8258A-H1-00

40 ft.- 6X6-8258A-J1-00



Command Link® 2nd Station Main Harness

The DEC second station main harness connects the main station control box with the second station control with the help of a secondary harness. The second station main harness has one 6 pin, one 4 pin, and one 3 pin connections on each end. One second station primary harness is required per engine when rigging a second station. For use with current Command Link® controls ONLY because of a different style 3 pin connector. Because of the different 3 pin connector, an adaptor harness will be required when a CLP main station is connected to a current Command Link® second station.

16 ft.- 6X6-8258A-A1-00
26 ft.- 6X6-8258A-C1-00

40 ft.- 6X6-8258A-E1-00



DEC 2nd Station Secondary Harness

The DEC second station primary harness connects the main station control box with the second station control with the primary harness. The secondary harness has one 12 pin connector on the main station side and one 2 pin connection on the second station side. One second station secondary harness is required per engine when rigging a second station. For use with CLP and current Command Link® controls.

16 ft.- 6X6-8258A-B1-00
26 ft.- 6X6-8258A-D1-00

40 ft.- 6X6-8258A-F1-00



Quad Second Station Harness

The Quad second station harness connects the main station control box with the second station control with the help of the primary and secondary harness. The Quad second station harness has two 12 pin connectors on the main station side and two 3 pin connectors on the second station side. One Quad second station harness is required along with two CLP primary and two secondary harnesses when rigging a second station. For use with CLP only.

16 ft.- 6X6-8258A-R0-00
26 ft.- 6X6-8258A-S0-00

40 ft.- 6X6-8258A-T0-00



Second Station Primary Harness Adaptor

The CLP and original DEC second station controls use a different style 3 pin connector on the primary harness. The adaptor harness will allow the use of a CLP control box for the main station and an original DEC control on the second stations. Perfect for the customer looking to re-power.

6X6-8258A-K0-00

CLP AGI / Gateway Harness

The .3 ft. harness connects a Pigtail Harness to either the AGI or a Gateway. The harness has a wrap of green tape and a male 6 pin at one end with a female 4 pin at the other.

6Y9-83553-50-00



CLP NMEA 2000® Gateway Harness for 6YG Gateway

6YG-82521-00-00

CLP Adapter Leads / Harnesses

Wire Lead Fuel Tank Sender for CL7 Display 6YD-8356N-00-00

Wire Lead , GPS for CL7 Display 6YD-83553-00-00

CLP Multisensor Harness

The Multisensor harness has a female 6 pin connector on one end and a male connector on the other. The .7 ft. harness connects a Pigtail Harness to the Multisensor and has a wrap of yellow tape.

6Y9-83553-60-00



CLP Display Harness

The Command Link Plus Display Harness has a 6 pin male connection on one end and a 4 pin female connection on the other. The .5 ft. harness connects a Pigtail Harness to the Command Link Plus Display and has a wrap of black tape in the middle.

6Y9-83553-40-00



Main Bus Y Harness

The Main Bus Y Harness connects the 6 pin control box lead into two main bus harnesses. This harness is used in installations with a CLP Display, Multisensor, and two stations. Please see appropriate diagram for more details.

6Y9-83553-10-00



CLP Main Bus Adaptor Harness

The adaptor harness connects the 6 pin control box lead to a main bus harness. This harness is used in installations with a CLP Display and has a 6 pin connection each end. Please see appropriate diagram for more information.

6Y9-83553-00-00



Fuel Harness for CLP

The Fuel Harness allows the vessel fuel information to be used with the Command Link Plus® Display.

6Y9-8356N-10-00



GPS Harness for CLP

The GPS Harness allows the GPS speed information from a GPS unit to be used with the Command Link Plus® Display.

6Y9-8356N-01-00



General Information

Rigging Estimate Guide (Diagrams)

Rigging Components

Electrical Components

Engine Accessories

Propellers

Maintenance Items

Oils & Lubes

Detailing & Trailer Supplies

Accessories & Apparel

Generators & Accessories



Fuel Harness for CLP CL7 Display

The Fuel Harness allows the vessel fuel information to be fed to the Command Link Plus® CL7 Display.

6YD-8356N-00-00



GPS / Fuel Harness for CL

The GPS / Fuel Harness allows the speed of the vessel from a GPS and the fuel system information from the vessel to be used with the Command Link® system.

6Y8-8356N-01-00



GPS/ Power Harness for CLP CL7 Display

The GPS Harness allows the GPS speed information to be fed to the Command Link Plus® CL7 Display. Also includes the power leads for the GPS antenna.

6YD-83553-00-00



Main Station Key Switch Adaptor Harness

The Main Station Key Switch Adaptor Harness allows the use of a current key switch with a Command Link Plus® control box. One harness is required per key switch, except single engine installations.

6X6-8258A-L0-00



Single 2nd Station Key Switch Adaptor Harness

The adaptor harness allows the use of a current key switch with a Command Link Plus® control box. One harness is required per installation.

6X6-8258A-M0-00



Twin 2nd Station Key Switch Adaptor Harness

The adaptor harness allows the use of a current key switch with a Command Link Plus® control box. One harness is required per installation.

6X6-8258A-N0-00



Triple 2nd Station Key Switch Adaptor Harness

The adaptor harness allows the use of a current key switch with a Command Link Plus® control box. One harness is required per installation.

6X6-8258A-P0-00



6X7 Flush Mount Key Switch Extension Harness

Used to connect main key switch that would otherwise be too far away for the control box connector to reach.

6X7-82590-30-00

Command Link® and Command Link® Plus Accessories

Y-COP®

The Electronic Control Module disables the ignition system via an operator controlled key fob. When the operator wishes to use the outboard, a simple command via the wireless key fob activates the ignition system. Two water resistant key fobs are provided with each system. (Replacement Remote: 6AA-86261-22-00, Replacement Unit: 6Y8-86260-11-00, Replacement Decal: 6Y8-48277-00-00) Includes a 2ft. pigtail harness.

6Y8-W0035-87-00



Y-COP® CL Key Switch Harness for Twin and Triple Engine Installations

The harness has three one pin connectors to tie Y-COP® into the key switches. Photo not available.

6Y8-81315-00-00



Y-COP® Harness for Multiple Engine Installations

The harness connects to the Key Switches, Power Supply, the Y-COP®, and a Pigtail Bus Harness. This harness is required when using Y-COP® in twin and triple installations with the new CLP key switches.

6Y8-81315-01-00



Power Y Harness for CLP

The Power Y Harness connects the 8 ft. Power Lead to two multi hub assemblies for use with the new CLP Display and CL gauges. Please see appropriate diagram for more details.

6Y9-83553-20-00



General Information

Rigging Estimate Guide (Diagrams)

Rigging Components

Electrical Components

Engine Accessories

Propellers

Maintenance Items

Oils & Lubes

Detailing & Trailer Supplies

Accessories & Apparel

Generators & Accessories



Command Link® / Command Link Plus® Gateway

Yamaha's Gateways allow certain engine and boat data to be displayed on NMEA-2000® compatible displays that are external to the Yamaha system. The Gateway is for installation with a Command Link® or Command Link Plus® networks, such as those found with mechanical controls and/or DEC controls. (requires pigtail harness for installation)

MAR-GTWAY-KT-10



Command Link® / Command Link Plus® Analog Gauge Interface

The Analog Gauge Interface, or AGI, allows Command Link® Plus or Command Link® equipped boats to display selected engine and boat performance data on analog gauges, be they Yamaha or those of most aftermarket manufacturers. The AGI is for installation with a Command Link® or Command Link Plus® network, such as those found with mechanical controls and/or DEC controls. (requires pigtail harness for installation)

6Y9-8A2D0-30-00



Command Link® Auto Trim Tab Retractor Interface

The trim tab retractor interface provides up to two engine analog tachometer outputs needed for some automatic trim tab retractors.

MAR-6X6DA-C0-00



Command Link® / Command Link Plus® Multisensor

The multisensor is utilized to provide water depth, water temperature, and water speed information to the Command Link Plus display or Command Link® Gauges. This multisensor has only one plug to power the unit and send signals to the ECU. It is powered through the Command Link Plus network. (Kit Includes: InLine Hub 6Y8-81920-11-00, 1 ft. Pig Tail Harness 6Y8-82521-01-00, Adaptor Harness 6Y9-83553-60-00, Multisensor 6Y9-83688-00-00)

MAR-3DCER-KT-00



Command Link® Thru-hull Multisensor

The multisensor is utilized to provide water depth, water temperature, and water speed information to the Command Link gauges. This multisensor was developed specifically for the Command Link® systems and has only one plug to power the unit and send signals to the ECU. The plug from the multisensor will not plug directly into the hub and requires a bus harness to plug it into the hub. It is powered through the Command Link® harness. The multisensor is available in two configurations:

Plastic Thru-hull: 6Y8-83688-11-00

Bronze Thru-hull: 6Y8-83688-20-00

Electronic Cooling Water Pressure Sensor

The water pressure sensor kit taps into the engine block's cooling passage and converts the pressure readings to an electrical signal that is sent to the engines' ECU. The ECU can then display this data on the tachometer. This sensor kit is optional for Command Link Plus® and Command Link®, and there are two types depending on model of the engine. These sensors plug into harness leads that are part of the engine's wiring harness. V8 engines come standard with a cooling water pressure sensor. (Replacement sensor: 6AW-8366B-01-00)

Kit for F40-F115 and HPDI: 60V-8A4L0-19-00

Kit for F150-F250, VMAX SHO®, and 4.2L Offshore: 69J-8A4L0-15-00



Thermostat Cover for VMAX SHO®

Allows the installation of sensor kit 60V-8A4L0-11-00 on VMAX SHO® engines.

4.2L - 6CE-12413-C0-9S

VF115- 6DA-1241B-00-9S



Electronic Speed Sensor

The speed sensor converts the water pressure from the lower units' pitot tube to a digital signal inside the engines ECU. The ECU then displays the speed on the speedometer. The kit contains all of the components necessary to connect the sensor to the pitot hose coming from the lower unit and one kit fits all. V8 outboards do not have speedo tube required for connection to this sensor. (Replacement Sensor: 6AW-8366B-01-00)

60V-8A4L1-18-00



Display Cover for Command Link® Displays

Protect your display with this stylish and durable cover.

Command Link Plus® Display: 6Y9-87278-00-00

6YC Display: 6YC-87278-00-00

CL7 Display: 6YD-87278-00-00



Remote Variable Trolling RPM Switch Kit (VTS)

With this new switch, increased VTS functionality is at your fingertips by adjusting the RPM without the gauge. The switch is compatible with F25C, F30 through F115 and VF115 (remote control models only). This helm-mounted remote switch connects to tiller handle input on the outboard. A brand new way to make fishing (and boating) easier at a low cost with huge benefits. The switch comes with a 26 foot harness length.

MAR-VTSSW-00-KT



General Information

Rigging Estimate Guide (Diagrams)

Rigging Components

Electrical Components

Engine Accessories

Propellers

Maintenance Items

Oils & Lubes

Detailing & Trailer Supplies

Accessories & Apparel

Generators & Accessories

Conventional Harnesses



Main Harness

The main harness is used to connect the engine to the electrical part of conventional controls. Available in both 7 Pin and 10 Pin configurations. 7 Pin harnesses do not contain the wires for power trim and tilt.

7 Pin 16.4 ft.- 688-82586-50-00	10 Pin 23 ft.- 688-8258A-70-00
10 Pin 16.4 ft.- 688-8258A-50-00	10 Pin 26.6 ft.- 6K1-8258A-40-00
10 Pin 19.7 ft.- 688-8258A-60-00	10 Pin 31.2 ft.- 61B-8258A-01-00



Main Harness Extension

The harness extension is used to connect the engine to the main harness, perfect for those special applications.

7 Pin 6.6 ft. 688-82586-11-00	10 Pin 9.8 ft. 688-8258A-30-00
10 Pin 6.6 ft. 688-8258A-10-00	



703 Control Box Main Harness

The replacement main harness for the 703 control box has the standard engine connection on one end and bullet connectors on the other. Both the 7 and 10 pin harnesses are 16 feet in length.

7 Pin 688-82586-21-00	10 Pin 688-8258A-20-00
------------------------------	-------------------------------



Dual Fuse Gauge Harness

Used to connect conventional gauges to key one power, battery positive, and other important sources. 10 ft.

6Y5-83553-N0-00

7 to 10 Pin Adaptor Harness

The 7-10 Pin harness is used to connect 7 Pin engines to 10 Pin main harnesses. 1.6 ft.

703-8258A-00-00



2005 and Later Trim and Oil Harness

Used on outboards to transfer information to conventional gauges. One white 4 pin connection on each end.

16.4 ft.- 6Y5-83653-00-00

19.7 ft.- 6Y5-83653-10-00

23 ft.- 6Y5-83653-20-00

26.3 ft.- 6Y5-83653-30-00

30 ft.- 6Y5-83653-40-00

35 ft.- 6Y5-83653-50-00



2004 and Prior Trim and Oil Harness

Used on outboards to transfer information to conventional gauges. Two white 4 pin connection on each end.

16.4 ft.- 68F-82553-50-00

20ft.- 68F-82553-60-00

23 ft.- 68F-82553-70-00

26.3 ft.- 68F-82553-80-00

31.2 ft.- 68F-82553-90-00

32.8 ft.- 68F-82553-A0-00



Trim Harness

Used to transfer the trim signal to aftermarket gauges on 2004 and prior outboards. One white 4 pin connection on each end.

10 ft.- 6R3-82553-30-00

16.4 ft.- 6R3-82553-50-00

23 ft.- 6R3-82553-70-00

26.3 ft.- 6R3-82553-80-00

31.2 ft.- 6R3-82553-90-00

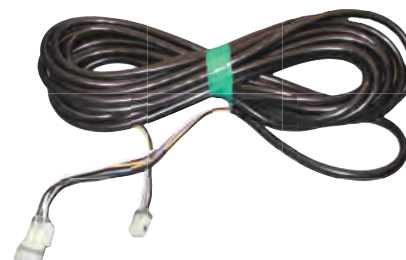

Oil Tank Harness

Used on two stroke outboards to connect the remote oil tank with one blue 4 pin connection on each end.

9.8 ft.- 6R3-85721-30-00

16.4 ft.- 6R3-85721-50-00

26.3 ft.- 6R3-85721-80-00



General Information

Rigging Estimate Guide (Diagrams)

Rigging Components

Electrical Components

Engine Accessories

Propellers

Maintenance Items

Oils & Lubes

Detailing & Trailer Supplies

Accessories & Apparel

Generators & Accessories



Fuel Management Harness

Multifunction gauge to fuel flow sender and tank sender. Can connect up to two fuel flow senders.

26 ft.- 6Y5-83553-F1-00



Fuel Flow Sender to Wire Harness Extension

Installs between a fuel sender and the fuel sender harness to accommodate longer runs. 9.8 ft.

6X1-82531-00-00



Wire Extensions Bullet Connector

If more than one instrument is used, additional jumpers will be required. These are available color coded to match the gauge harness. 1 foot in length and available in black, blue, and yellow.

Black: 6Y5-82117-00-00

Yellow: 6Y5-82521-00-00

Blue: 6Y5-82149-00-00



2 Pin Connector to Bullet Connector Adaptor

For use on 64D stop lanyard

Female 2 Pin to 2 Male Bullet Connectors: 6X3-81971-00-00

Male 2 Pin Connector to 2 Female connectors: 6X3-81971-10-00



Multifunction to GPS Harness

Connects the multifunction speedometer to a GPS input.

6Y5-87122-S0-00



Tachometer Harness

For applications with no remote control or a 701 control box. 16.4 ft.

6Y5-83553-10-00



Extension Harness for remote mount PTT Switch

Three lead bullet connector extension 6.6 ft.

6H5-82553-00-00

Yamaha Main Harness to Aftermarket Control Box Connector

The sub harness is used to connect the 10 pin harness to an aftermarket control box. It includes the connections for PTT and neutral safety switch.

704-82541-10-00



Aftermarket Main Harness to Yamaha Control Connector

This harness connects an aftermarket main harness to a 704 control box.

704-85721-00-00

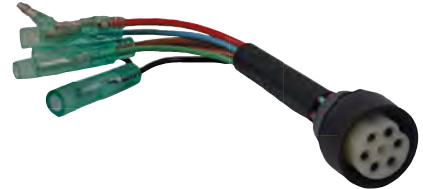

Trim Adapter Harness Square Female to Bullet Connectors

Used on 1994~2004 engines to connect the trim signal to a 1993~ harness except for ~1993 250 HP boat harness.

6N7-82541-10-00

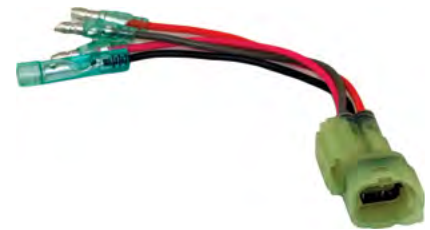

Oil Tank Adapter Harness Square Female to Round Male

Used on 2 stroke engines with an in boat tank to connect the Trim and Oil Harness and oil tank harness.

6R3-82541-00-00



Oil Tank Adapter Harness Square Male to Round Female

Used on 2 stroke engines with an in boat tank to connect the Trim and Oil Harness and oil tank harness.

6R3-82541-10-00



General Information

Rigging Estimate Guide (Diagrams)

Rigging Components

Electrical Components

Engine Accessories

Propellers

Maintenance Items

Oils & Lubes

Detailing & Trailer Supplies

Accessories & Apparel

Generators & Accessories



Tachometer Adapter Harness

Adapter for one lead tach (-90) to 2004 and prior engines

6Y5-85335-10-00



Tachometer Adapter Harness

Adapter for two lead Tach (-82) to 2005 and later engines

6Y5-85335-00-00



Waterproof Plug

Fits ~2004 trim and oil harnesses when connecting to 2005~ engines.

6R8-82582-00-00

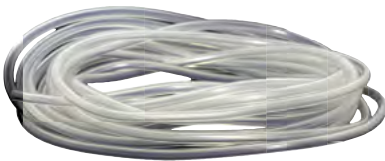

Speedometer Tubing

For connecting analog signal speedometers to the speed pick up.

30' length: 6Y5-83557-10-00

300' length: 6Y5-83557-40-00



Water Temperature Sender

Two wire sender for cooling water temperature gauges.

688-83591-00-00

Conventional Accessories

Yamaha Engine Meters

To help you maintain your generator at proper service intervals, the intervals are pre-programmed into this meter (10 hours initial, every 50 hours thereafter). Upon reaching the specified service interval, the meter displays a flash alert for a two-hour period.

Deluxe Hour Meter (Hour Meter Only): *ENG-METER-2C-01*

Deluxe Hour Meter & Tachometer: *ENG-METER-4C-02*



Water Pressure Adaptor

Provides most Yamaha Outboards a water-jacket tap with a hose barb to adapt aftermarket pressure gauges which use a 1/8" ID (3/16" OD) rubber hose.

MAR-WPRES-AD-TR

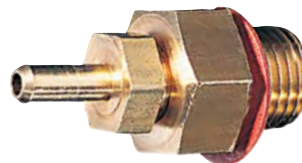

Water Pressure Sender

Includes water jacket tap, hose, and nuts for installation on most Yamaha Outboards. (Ferrule and Nut 663-83668-00-00, Gasket 90430-14115-00 for gauge side)

688-83667-00-00



Water Pressure Dampener

Installing the water pressure damper between the gauge and water tube is recommended when the pointer of analog gauge is wiggled if water pressure pulsates or to reduce a risk if water has leaked at connector end causing the gauge damage.

6Y5-83728-00-00

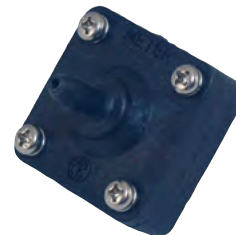

Speedometer Pickup Sender

The speedometer pick up can assist in high-performance applications, where the engine is mounted at elevated levels, or with the Yamaha V8 outboards without a speed pick up in the lower unit.

688-83556-00-00



Fuel Flow Sensor

Replacement sensor for use with Yamaha's fuel management and speed / fuel gauges.

6Y5-85752-02-00



General Information

Rigging Estimate Guide (Diagrams)

Rigging Components

Electrical Components

Engine Accessories

Propellers

Maintenance Items

Oils & Lubes

Detailing & Trailer Supplies

Accessories & Apparel

Generators & Accessories

Charging, Starting, and Battery Cables



Rectifier Kit

For manual start models with a lighting coil. May require additional parts: Washer 92990-06600-00, screw 98580-05525-00, and Bolt 97013-06010-00.

676-81970-01-00



F6 / F4 Charge Kit

Allows the customer to have voltage output from the engine. For use on current F4 and F6 engines.

6BX-W8130-A0-00



Lighting Coil Extension Harness

Allows regulators and rectifiers to be mounted outside of the cowl in cases where electrical parts or portable engines may need to be removed for storage.

682-84380-00-00



Battery Isolator Leads

With 50A Circuit Protection 13.5 ft: **MAR-69JIS-0L-ED**

Without Circuit Protection 12 ft: **69J-81949-02-00**

4.2 L 100A Circuit Protection 14 ft: **MAR-6CEIS-1L-ED**

4.2L without Circuit Protection: **6CE-81949-00-00**

With 200A Breaker 12ft: **MAR-6GRIS-LE-D0**

With Cable, Washer, Nut No Fuse 12ft: **6GR-762W0-00-00**

4 Stroke F6 (~04/06)*, F8, F9.9 (04/08~) Electric Start Kit

Convert a manual start engine into electric start. F6 will require additional parts listed below.

6DR-W8180-10-00

* Requires additional parts listed below.

QTY	Description	Part Number
1	Starter Motor Bracket	68T-81822-01-00
2	Bolt	97013-08055-00
3	Washer	92990-08600-00
1	Bolt	97014-08040-00
1	Clamp	90465-10098-00
1	Clamp	90465-08M99-00
1	Bolt	97080-06012-00
1	Washer	92990-06600-00



F25C Electric Start Kit

Convert a manual start engine into electric start.

6FM-W8180-00-00



Battery Engine Cables

Used to connect Yamaha Outboards to 12 V batteries.

2 Stroke Battery Cables

40-50	7.3ft.	63D-82105-J1-00
60,70, 90	7.8 ft.	6H0-82105-J2-00
115	9.4 ft.	6R3-82105-J2-00
V6 Carb	8.5 ft.	64D-82105-01-00
V6 EFI	8.7 ft.	67H-82105-01-00
2.6L HPDI	8.6 ft.	68F-82105-01-00
3.3L Z	11.2 ft.	60V-82105-01-00
3.3L VZ	8.1 ft.	60X-82105-00-00

4 Stroke Battery Cables

F25C	6.6 ft.	6FM-82105-00-00
F50-F60	7.3 ft.	6C5-82105-U1-00
F75-F115	9.3 ft.	68V-82105-J1-00
VF115		68V-82105-01-00
F150	8.6 ft.	63P-82105-01-00
VF150/175		6DA-82105-01-00
F200/ F225*	11.2 ft.	69J-82105-01-00
VF200-250	11.5 ft.	6CB-82105-01-00
F250*	11.2 ft.	6P2-82105-02-00
V8	11.5 ft.	6AW-82105-01-00
4.2L V6	11.5 ft.	6CB-82105-01-00

* Except 4.2L V6 Models

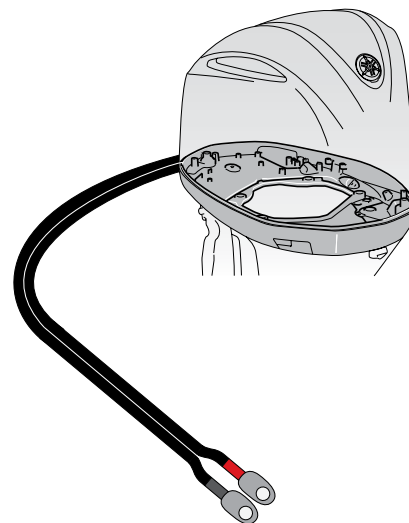

General Information

Rigging Estimate Guide (Diagrams)

Rigging Components

Electrical Components

Engine Accessories

Propellers

Maintenance Items

Oils & Lubes

Detailing & Trailer Supplies

Accessories & Apparel

Generators & Accessories

Switches and Indicators



Pull Style Light Switch

Two position, On - Off switch with a classic look.

688-82520-00-00



On - Off Toggle Switch

Two position toggle switch with protective cover.

688-82526-00-00



Remote Mount Trim Switch

Place trim/tilt functions right where you want them. Connects easily to main harness using the leads provided.

688-82563-10-00



Lighting Rocker Switch

These high quality attractive switches are great for adding additional components to a customer's rig.

GU1-U8029-00-00



Indicator Lamp

A durable red lamp with many useful purposes. Two lead connection.

663-84301-01-00

12 Volt Accessory Socket

Great for customers who like to use electronic gadgets or charge their cell phone on the water.

FOK-U8284-00-00



General Information

Rigging Estimate Guide (Diagrams)

Rigging Components

Electrical Components

Engine Accessories

Propellers

Maintenance Items

Oils & Lubes

Detailing & Trailer Supplies

Accessories & Apparel

Generators & Accessories

Wire Connections and Circuit Protection

The wire connectors listed below are available through Marine Rigging and Parts. For a complete wiring kit, contact K&L Tools at 1-800-708-3184.



Spade Connectors

Type	Size	Part Number	Minimum Order Qty.
Male	2.8 mm	90890-05199-00	10
Female	2.8 mm	90890-05200-00	10
Male	6.3 mm	90890-05201-00	10
Female	6.3 mm	90890-05202-00	10



Bullet Connectors

Type	Sockets	Part Number	Minimum Order Qty.
Male	1	90890-05159-00	10
Female	1	90890-05160-00	10
Female	2	90890-05205-00	10



Eye Connectors

Size	Part Number	Minimum Order Qty.
4 mm	90890-05207-00	10
6 mm	90890-05209-00	10
8 mm	90890-05210-00	10

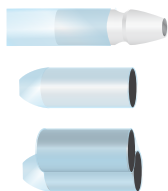

Insulators

Type	Part Number	Minimum Order Qty.
Male Bullet	90890-05161-00	10
Female Bullet	90890-05162-00	10
Twin Female Bullet	90890-05206-00	10



Miscellaneous Connectors

Type	Part Number	Minimum Qty.
Butt connector	90890-05211-00	10
50 Pack Male Terminal Pins, trim and oil harness	9E2-12103-03-00	1
50 Pack Female Terminal Pins, trim and oil harness	9E2-12113-03-00	1

The fuses and breakers listed here are for reference only. Always refer to PartsManager Pro™ for the correct protection for your engine application.

Standard Blade Fuses

Amps	Part Number	Minimum Order Qty.
5	1NL-82151-00-00	10
7.5	2KW-82151-00-00	1
10	42X-82151-00-00	10
15	36Y-82151-00-00	1
20	2GV-82151-00-00	10
30	1AE-82151-00-00	1
40	5EA-82151-00-00	1



Mini Blade Fuses

Amps	Part Number	Minimum Order Qty.
2	5JJ-82151-80-00	1
3	67F-82151-30-00	1
4	5JJ-82151-40-00	1
5	67F-82151-20-00	1
7.5	5JJ-82151-00-00	1
10	67F-82151-40-00	1
15	67F-82151-50-00	1
20	5JJ-82151-20-00	1
25	5JJ-82151-70-00	1
30	5JJ-82151-60-00	1



30 mm Glass Fuses

Amps	Part Number	Minimum Order Qty.
5	5G2-82151-00-00	10
10	1E6-82151-00-00	1
15	1UY-82151-00-00	1
20	682-82151-01-00	1
30	705-82151-00-00	1



20 mm Glass Fuses

Amps	Part Number	Minimum Order Qty.
7	27V-82151-00-00	10
10	1A0-82151-00-00	1
30	2H7-82151-00-00	10



General Information

Rigging Estimate Guide (Diagrams)

Rigging Components

Electrical Components

Engine Accessories

Propellers

Maintenance Items

Oils & Lubes

Detailing & Trailer Supplies

Accessories & Apparel

Generators & Accessories



Breakers

Amp Rating	Part Number
3 amp	F1C-U8348-10-00
4 amp	F1C-U8348-20-00
5 amp	F1C-U8348-00-00
10 amp	F1C-U8348-30-00
Cover for Breaker (Screw on)	F0R-U8188-10-00

(Insulated cover shown is sold separately.)



Fuse Cartridges

Amps	Part Number	Minimum Order Qty.
50	63P-82151-00-00	1
60	6P2-82151-00-00	1
80	61A-82151-00-00	1
100	6CE-82151-00-00	1



Description	Page
Fuel System Components	5-1
2-Stroke Oil Systems	5-5
Rigging Tubes and Grommets	5-6
Steering System	5-7
Remote Control Attachment Kits	5-10
Tiller Handles and Fitting Kits	5-13
Cowling Covers	5-14
Custom Cowling Graphics	5-16
Engine Security	5-17
General Engine Accessories	5-18
Tilt Limiters	5-19
XTO Offshore® V8 Models Automatic Flushing System	5-20

General
Information

Rigging Estimate
Guide (Diagrams)

Rigging
Components

Electrical
Components

**Engine
Accessories**

Propellers

Maintenance
Items

Oils
& Lubes

Detailing &
Trailer Supplies

Accessories
& Apparel

Generators
& Accessories



Fuel System Components



10-Micron Fuel/Water Separating Filter

They are a primary line of defense against ethanol-related fuel system issues. Highly recommended for all two stroke and four stroke EFI outboards and two stroke HPDIs. Also excellent for carbureted engines. New, improved 10-micron filter provides superior filtration ahead of the engine's onboard filters and injectors. Large filtering and water capture areas maximizing filtration while maintaining adequate flow rate for larger engines.

Assemblies

Assembly Stainless Steel Head **MAR-10MAS-10-00**

Assembly Stainless Steel Head 3/8" Fittings **MAR-10MAS-20-00**

Assembly Aluminum Head **MAR-10MAS-00-00**

Elements

Spin-On Filter Only **MAR-10MEL-00-00**

Bulk pack of 12 **MAR-10MEL-00-BK**

Filter Heads

Aluminum Filter Head 12 Pack **MAR-FLTHD-AL-12**

Stainless Steel Filter Head 12 Pack **MAR-FLTHD-SS-12**

Stainless Steel Filter Head 3/8" Fittings 12 Pack **MAR-FLTHD-20-BK**

mini-10™

Assembly Aluminum Head **MAR-MINIF-LT-AS**

Spin-On Filter only **MAR-MINIF-IL-TR**



Yamaha Remote Filter

Assembly includes aluminum mounting head, spin-on element, metal bowl, and water sensor probe. Requires Yamaha Multifunction Fuel Management Gauge for water detection indication.

Assemblies

Elements

60 GPH **MAR-24563-00-00**

90 GPH **MAR-10171-20-00**

Filter Bowls

Clear Bowl without water probe **MAR-REPLB-OW-L1***

Clear bowl with water probe **MAR-REPLB-OW-L2***

Replacement Water Probe **MAR-10171-30-00**

* For above deck use only

Portable Gas Tank

Meets Environmental Protection Agency (EPA) regulations that became effective January 1, 2011.

25 Liter (6.6 gallon) **6YK-24201-44-00**

12 Liter (3.1 gallon) **6YL-W2420-J5-00**



Replacement Fuel Tank Parts for EPA Style Tank

Filler Cap with Gasket **6YL-24610-10-00**

Filler Cap Gasket Only **6YL-24641-10-00**

Filler Cap Lock Ring **6YL-24629-00-00**



Replacement Fuel Tank Parts for Pre-EPA Fuel Tank

Filler Cap Gasket for both 6.6 and 3.1 Gallon Tanks **MAR-COMBI-GS-KT**

Pick Assembly for 3.1 Gallon Tank **97951-24261-00**

Pick Assembly for 6.6 Gallon Tank **97951-24262-00**



Scepter ECO® Gas Cans

Rustproof, unbreakable, non-corroding, with spill-proof spout that automatically shuts off when tank is full. UL listed. Meets CARB requirements.

5 Gallon "Jerry Can" **MAR-CARBC-FC-JC**

2.5 Gallon Can **MAR-CARBC-FC-25**

Replacement spout **MAR-CARBC-FC-SP**



General Information

Rigging Estimate Guide (Diagrams)

Rigging Components

Electrical Components

Engine Accessories

Propellers

Maintenance Items

Oils & Lubes

Detailing & Trailer Supplies

Accessories & Apparel

Generators & Accessories



Yamaha Fuel Line Assemblies

Fuel line built to last. Your engine doesn't run without fuel, so make sure it has a steady supply. Yamaha's fuel line is built to strict standards and meets EPA regulations.

Inside Diameter	Engine Side Connection	Tank Side Connection	Length	Part Number
8mm	Conventional	Conventional	9.8 ft	6YK-24306-64-00
6mm	Conventional	Conventional	9.5 ft	6YL-24306-64-00



Yamaha Fuel Line

8mm Fuel line only. Primer bulb and connections are not included. Yamaha's fuel line is built to strict standards and meets EPA regulations.

Application	Length	Part Number
F150	3.5 ft	63P-24316-21-00
F200, F225	3.5 ft	6P2-24314-11-00
F75, F90, F115	4.3 ft	90445-13025-00
115, V150, HPDI	8.9 ft	90445-13016-00



Yamaha Bulk Fuel Line

6mm and 8mm 30M Fuel line. Primer bulb and connections are not included. Yamaha's fuel line is built to strict standards and meets EPA regulations.

Diameter	Length	Part Number
6mm	98 ft	90798-1M599-00
8mm	98 ft	90798-1M598-00

*Yamaha recommends the use of these size Oetiker® clamps for these fuel lines
11.5mm to 14mm for 6mm fuel line/13.2mm to 15.7mm for 8mm fuel line

Fuel Line Connections

Connection Description	Style	6mm Part Number	8mm Part Number
Hose Mounted Tank Side	Conventional	6Y1-24305-06-00	6Y2-24305-06-00
Hose Mounted Engine Side	Conventional	6G1-24305-05-00	6E5-24305-06-00



Primer Bulbs

Size	Application	Part Number
8mm	F70~F225, 2-S 115~V150 & HPDI	6YK-24360-73-00
8mm	XTO,F350,F300, F250, 4.2L Engines	6AW-24360-01-00
6mm	Portable Outboards	6YL-24360-63-00
6mm	F4 / F6 Under the Cowl	6BX-24360-10-00



Miscellaneous Fuel Line Connections

Joints are used to connect two pieces of fuel line together. The plug is a great tool for plugging off open fuel line to prevent debris from entering the fuel line.

Description	Part Number
6mm to 8mm Joint (5 pack)	67F-24377-00-BK
8mm Joint	6R3-24377-10-00
Joint Cover	68V-24452-00-00
Plug	689-85547-00-00



General Information

Rigging Estimate Guide (Diagrams)

Rigging Components

Electrical Components

Engine Accessories

Propellers

Maintenance Items

Oils & Lubes

Detailing & Trailer Supplies

Accessories & Apparel

Generators & Accessories

2-Stroke Oil Systems



Oil Deck Filler Kits

Threaded reduction fitting with deck plate and “keyless” screw-on cap. Has restrictor and oil label to deter someone from accidentally filling your oil tank with gasoline. Angled version swivels for a precise fit. Uses 1 1/2" ID oil-resistant hose (not included).

Straight Deck Fill **ABB-PLATE-DE-CK**

Replacement Parts

90 Degree Joint **6E5-24478-01-00**

45 Degree Joint **ABB-JOINT-45-00**

O-ring **ABB-ORING-DE-CK**

Gasket **6E5-24482-00-00**



Remote 2.8 Gallon Oil Tank Kit

All the required parts to install a remote oil tank in one easy to order kit.

6YR-W0035-95-00

Kit Includes:

Quantity	Description	Part Number
1	Oil Tank Sub Assy (10.5L)	6E5-21733-20-00
1	Clamp	90465-13M11-00
1	Bracket, Damper Assy	6E5-21798-01-33
1	Hose Clamp Assy	90450-10M07-00
1	Nut	95380-06600-00
1	Clamp	90465-10098-00
1	Holder, Sub Oil Tank	6E5-21734-01-33
1	Bolt	97080-06100-00
1	Washer, Plain	92990-06600-00
1	Oil Feed Pump	6E5-81900-01-00
1	Oil Level Gauge	6E5-85720-06-00
1	Primer Bulb Assembly	6AW-24360-01-00
1	Oil Line	90445-11M00-00

Transom Fitting For Rigging Hose

An easy install. Just thread the Rigging Hose onto the fitting. Requires no clamp, yet provides positive engagement. Use with Rigging Grommet (sold separately) for quick, easy rigging.

- 2" Black **MAR-THRUT-RS-M2**
- 2.5" Black **MAR-TFLNG-25-BK**
- 2" White **MAR-FLNG2-0W-T0**
- 2.5" White **MAR-TFLNG-25-WT**
- Chrome **ABA-THRUT-RA-SM**



Rigging Grommet

Choose the grommet for your engine. Simply thread the Rigging Hose and thread the Transom Fitting (sold separately) onto the other end. Provides positive engagement without clamps.

- 2 Stroke 115-250 **MAR-GROMM-ET-01**
- F150 **MAR-GRMMT-F1-50**
- F200-F250 **MAR-GRMMT-LG-4S**
- Z250, Z300 **MAR-GRMMT-Z2-50**

Other '02 ~ V4 and V6 models include the main grommet, but require the following hardware to attach the rigging hose.

- Fastener **68F-42753-00-00**
- Clip **90601-20022-00**



Rigging Hose

High-quality hose is flexible, crush-resistant with UV inhibitors for added protection. Black, Gray, or Metallic Blue.

- 25' Black 2" (one roll) **MAR-RIGHS-BK-25**
- 25' Black 2.5" (one roll) **MAR-RHS25-BK-25**
- 100' Black 2" (two 50' rolls) **MAR-RIGHS-BK-50**
- 100' Black 2.5" (two 50' rolls) **MAR-RHS25-BK-50**
- 25' Gray 2" (one roll) **MAR-RIGHS-GY-25**
- 100' Gray 2" (two 50' rolls) **MAR-RIGHS-GY-50**
- 25' Metallic Blue 2" (one roll) **ABB-RIGHS-BE-25**



Rigging Hose

High-quality hose is flexible, crush-resistant with UV inhibitors for added protection. **Now In White!**

- 25' White 2" (one roll) **MAR-RHS20-WT-25**
- 25' White 2.5" (one roll) **MAR-RHS25-WT-25**
- 100' White 2" (two 50' rolls) **MAR-RHS20-WT-50**
- 100' White 2.5" (two 50' rolls) **MAR-RHS25-WT-50**

General Information

Rigging Estimate Guide (Diagrams)

Rigging Components

Electrical Components

Engine Accessories

Propellers

Maintenance Items

Oils & Lubes

Detailing & Trailer Supplies

Accessories & Apparel

Generators & Accessories

Steering System



Steering Link Arm Kits

Connects Yamaha outboards to the boat's steering system. Some Yamaha outboards will come with a steering link arm kit in the crate. Please refer to the latest Product Information Guide for more details.

2-Stroke Model	Steering Guide Kit
9.9, 15	63V-61350-00-00
25/30	689-61350-02-00
40/50 (~1995)	689-61350-02-00
40/50 (1996~)	63D-61350-00-00
60~90	688-61350-10-00
115~300	6E5-61350-02-00

4-Stroke Model	Steering Guide Kit
F8 (~04/2006)	68T-61350-00-00
F8 (04/2007~)	68T-61350-10-00
T8	68T-61350-00-00
F9.9 (~04/2005)	6G8-61350-00-00
F9.9 (2)	63V-61350-00-00
F9.9F	68T-61350-10-00
T9.9 (~04/2005)	6G8-61350-00-00
T9.9(2)	63V-61350-00-00
T9.9G	68T-61350-10-00
F15	63V-61350-00-00
F15C, F20	6AH-61350-00-00
F25 (~04/2005)	65W-61350-00-00
F25A/T25A	6BG-61350-00-00
T25 (~04/2006)	65W-61350-00-00
F30	65W-61350-00-00
F40 (1999)	63D-61350-00-00
F40 (2000~)	65W-61350-00-00
F40A	6BG-61350-00-00
F50/T50 (1996~2004)	63D-61350-00-00
F50/T50 (2005~)	65W-61350-00-00
F60/T60	65W-61350-00-00
F70	65W-61350-00-00
F75 ~ F100	67F-61350-00-00
F115B (2014~)	6EK-61350-00-00
F115~F300 (V6)	6E5-61350-02-00

Steering Hooks

Used to attach the steering arm to the outboard. Will require bolts or studs, nuts and washers to install. Please refer to PartsManager Pro™ for additional part numbers required.

2-Stroke Model	Steering Hook
9.9	63V-48511-01-00
15	63V-48511-01-00
25 (Manual Start)	689-48511-02-00
25 (Electric)	6J8-48511-52-00
30	6J8-48511-52-00

2-Stroke Model	Steering Hook
40	63D-48511-01-00
50	63D-48511-01-00
60	6H3-48511-52-00
70	6H3-48511-52-00
90	688-48511-12-00

4-Stroke Model	Steering Hook
F8	63V-48511-01-00
T8 (2001)	63V-48511-01-00
T8 (except 2001)	69G-48511-10-00
F9.9 (~04/2005)	6G8-48511-20-00
F9.9-2, F9.9 (04/2006~)	63V-48511-01-00
T9.9G, T9.9A	69G-48511-10-00
T9.9 (~04/2005)	6G8-48511-20-00
T9.9-2	63V-48511-01-00
F15	63V-48511-01-00
F15C	6AH-48511-01-00
F20	6AH-48511-01-00
F25	65W-48511-01-00
T25	65W-48511-01-00
F30	65W-48511-01-00

4-Stroke Model	Steering Hook
F40 (1999)	63D-48511-01-00
F40 (~2000)	65W-48511-01-00
F50 (~2004)	63D-48511-01-00
F50 (2005~)	65W-48511-01-00
T50 (~2004)	63D-48511-01-00
T50 (2005~)	65W-48511-01-00
F60	65W-48511-01-00
T60	65W-48511-01-00
F70	65W-48511-01-00
F75	67F-48511-01-00
F80	67F-48511-01-00
F90	67F-48511-01-00
F100	67F-48511-01-00
F115 (06/2011~)	68V-48511-01-00
F115B	688-48511-12-00

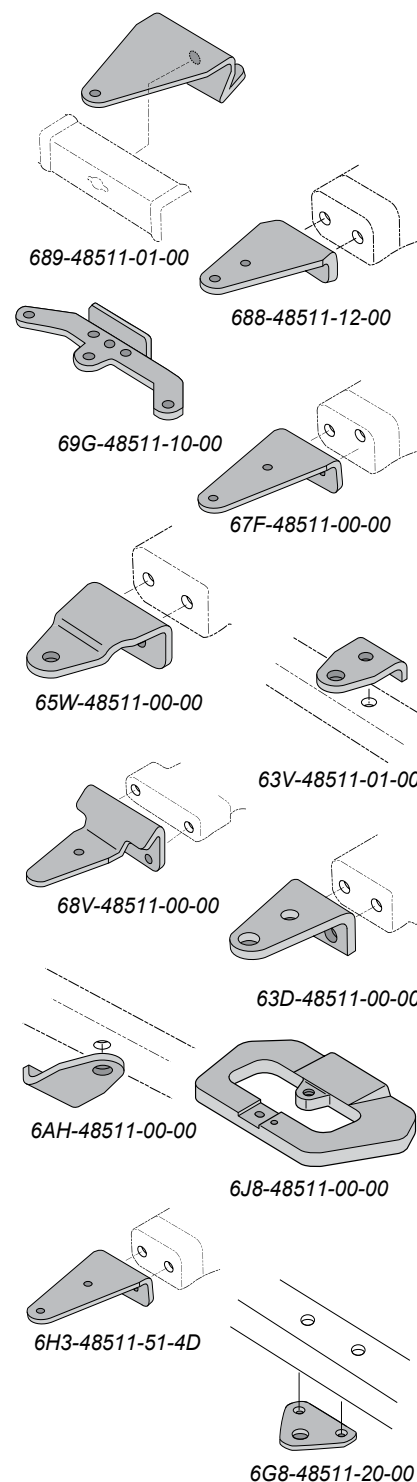

General Information

Rigging Estimate Guide (Diagrams)

Rigging Components

Electrical Components

Engine Accessories

Propellers

Maintenance Items

Oils & Lubes

Detailing & Trailer Supplies

Accessories & Apparel

Generators & Accessories



Dual Steering Cable Bracket

Strong, 7-gauge stainless construction, with aluminum steering tube. Conforms to ABYC® standards. Features a steel shield over the steering tube to provide additional protection. Fits 70–300hp engines.

ABA-DUALS-TE-ER

Replacement Tube (not shown) **ABA-DUALS-TR-01**



Universal Dual Steering Bracket

Pre-drilled to fit all major outboard motor brands. Features an aluminum steering tube and stainless steel bracket. Fits 70–300hp engines.

ABA-42110-00-00



Dual Steering Tie Bar Kit

Strong, stainless steel tie bar provides dual engine steering control for Yamaha outboards. Adjustable from 11" to 36". Includes necessary hardware.

ABA-DUALT-IE-BR

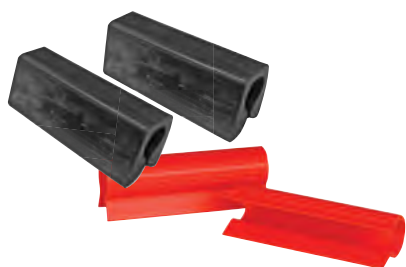

Outboard Steering Centering Clips

Outboard steering centering clips for use with front mounted hydraulic steering cylinders having an 8 inch total stroke length (side to side). Helps the outboard remain centered while trailered. The clips also help limit the load applied to the hydraulic system that may occur when an outboard is tilted and partially turned. The clips are quickly and easily installed over the hydraulic cylinder steering rods. Sold in pairs.

Black (Rubber): **MAR-CNTRC-LP-08**

Orange: **6ES-23326-00-00**



Zerk Nut

Stainless steel, with high pressure O-ring seal. Attaches to steering tube to keep lubrication in, contaminants out.

MAR-ZERKN-UT-01

Remote Control Attachment Kits

The remote control kits listed below may also be listed with additional parts required to install the remote control attachment kits. For the most accurate information always refer to PartsManager Pro™.

9.9/15 Outboards

Quantity	Description	Part Number
1	Throttle & Shift Kit	63V-48501-00-00
1	Steering Guide Attachment	63V-61350-00-00
1	Longer Steering Tilt Tube	63V-43131-10-00
1	Steering Hook	63V-48511-01-00
1	Bolt	97095-08035-00
1	Washer	92990-08600-00
1	Nut	95780-08300-00

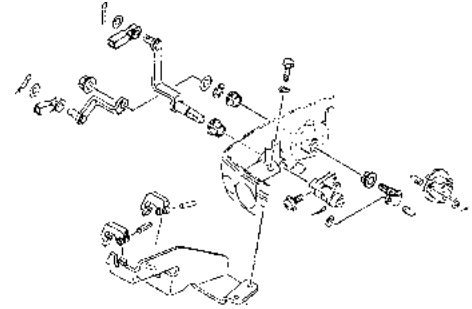

F6/F8 Outboards

Quantity	Description	Part Number
1	Throttle & Shift Kit	6DR-48501-01-00
1	Steering Guide Attachment	68T-61350-00-00
1	Steering Hook	69G-48511-10-00
2	Bolt	97095-08035-00
1	Nut	95780-08300-00
1	Nut	90185-06M07-00
1	Wire Harness (For Connection to Control)	69G-82590-00-00



F/T9.9 Models 85~06 1st Generation Outboards

Quantity	Description	Part Number
1	Throttle & Shift Kit	6G8-48501-03-00
1	Steering Guide Attachment	6G8-61350-00-00
1	Steering Hook (Steering Guide Type)	6G8-48511-20-00
1	Steering Hook (Ball Post Type)	6G8-48511-10-00
2	Bolt	97095-06016-00
2	Washer	92990-06600-00
1	Wire Harness (For Connection to Control)	6G8-82580-00-00

General Information

Rigging Estimate Guide (Diagrams)

Rigging Components

Electrical Components

Engine Accessories

Propellers

Maintenance Items

Oils & Lubes

Detailing & Trailer Supplies

Accessories & Apparel

Generators & Accessories

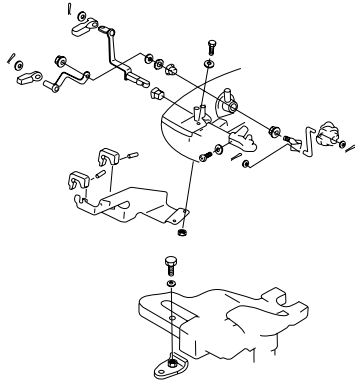

F/T9.9, F15 Models 01~05 2nd Generation, F/T9.92 06~07 Outboards

Quantity	Description	Part Number
1	Throttle & Shift Kit (Comes with hook)	66M-48501-00-00
1	Steering Guide Attachment	63V-61350-00-00
1	Longer Steering Tilt Tube	63V-43131-10-00
1	Wire Harness (For Connection to Control)	66M-82590-10-00

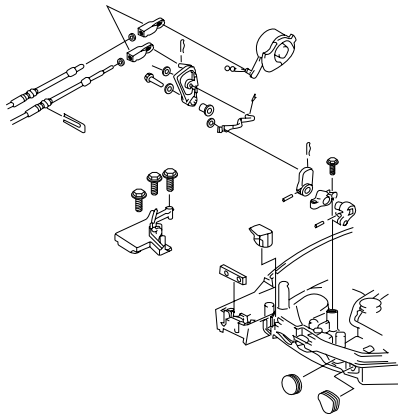

F/T9.9G 08~ Outboards

Quantity	Description	Part Number
1	Throttle Shift Kit F/T9.9 08~	6DR-48501-01-00
1	Steering Guide Attachment	68T-61350-10-00
1	Steering Hook (F9.9 08~)	63V-48511-01-00
1	Steering Hook (T9.9 08~)	69G-48511-10-00
2	Bolt W/Washer	97575-08535-00
1	Self-Locking Nut	95780-08300-00
1	Self-Locking Nut (For T9.9)	90185-06M07-00
1	Wire Harness (To Control For T9.9 Power Tilt)	69G-82590-00-00
1	Wire Harness (To Control For F9.9 Electric/Manual)	69G-82580-00-00

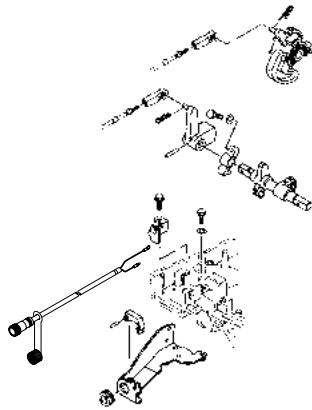

F15C / F20 Outboards

Quantity	Description	Part Number
1	Throttle and Shift Kit	6AH-48501-00-00
1	Steering Arm	6AH-61350-00-00
1	Steering Hook	6AH-48511-01-00
1	Bolt	97095-08025-00
1	Washer	92990-08600-00
1	Nut	95780-08300-00
1	Cap	6AH-44194-00-00
1	Wire Harness	99999-04179-00
1	Steering Tube for F15C only	69A-43131-00-00

25E Outboards

Quantity	Description	Part Number
1	Throttle & Shift Kit	6L2-48501-11-00
1	Steering Guide Attachment Kit	689-61350-02-00
1	Steering Hook	6J8-48511-52-00
1	Wire Harness (For Connection to Control)	6L2-82590-00-00

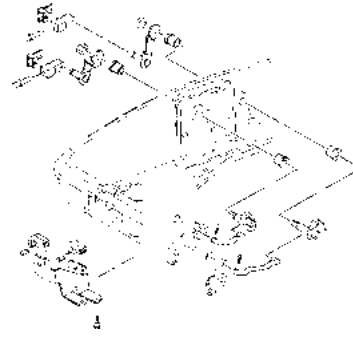

F25 Models SE/SM/LE/LM Outboards

Quantity	Description	Part Number
1	Throttle & Shift Attachment Kit (Comes with hook)	6BL-48501-00-00
1	Steering Guide Attachment	6BG-61350-00-00
2	Stud Bolt (For Hook)	90116-10064-00
1	Washer (For Hook)	92990-10600-00
1	Wire Harness SMHA/LMHA Models (To Control)	6BL-82590-10-00
1	Wire Harness SEHA/LEHA Models (To Control)	6BL-82590-20-00

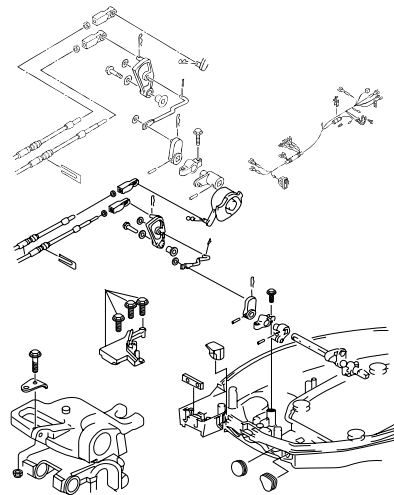

F25 ~06 Outboards

Quantity	Description	Part Number
1	Throttle & Shift Attachment Kit (Comes with hook)	65W-48501-00-00
1	Steering Guide Attachment	65W-61350-00-00
2	Stud Bolt (For Hook)	90116-10063-00
2	Nut (For Hook)	90185-10027-00
1	Wire Harness EH Models (Connection to Control)	65W-82590-20-00
1	Wire Harness MH Models (Connection to Control)	65W-82590-40-00

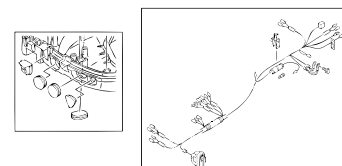
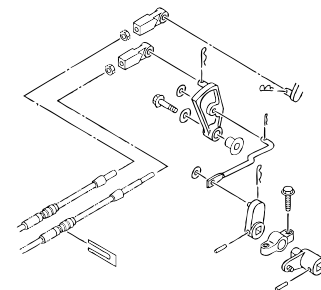

General Information

Rigging Estimate Guide (Diagrams)

Rigging Components

Electrical Components

Engine Accessories

Propellers

Maintenance Items

Oils & Lubes

Detailing & Trailer Supplies

Accessories & Apparel

Generators & Accessories

Tiller Handles

Yamaha's Multifunction Tiller Handle combines ergonomic design, smooth shifting, fingertip controls and an extended throttle handle for virtually effortless maneuverability. Add to that Yamaha's exclusive Variable Trolling RPM Switch (VTS® F40LA through F90 models only) and a 90° throttle rotation angle, and steering is not only easy, it's more comfortable too. It's easy to see why our Multifunction Tiller Handle won an IBEX® Innovation Award in 2005.

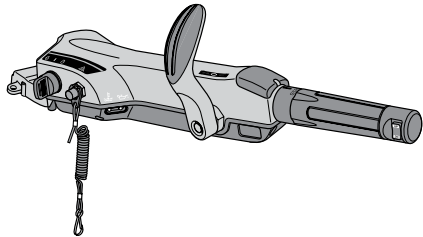

F25 Complete Tiller Handle Assembly (~2016)

Includes everything required to mount a tiller handle on F25 Outboard produced until 2016.

6X4-42103-0D-00



Tiller Handle Main Assembly

The tiller handle main assembly requires the use of a fitting kit below to mount to a Yamaha Outboard.

6X4-42103-58-00

Tiller Handle Fitting Kits

The fitting kits are used along with the Main Handle Assembly. They typically include the wire harness and mounting hardware.



2-Stroke Fitting Kits

Application	Part Number
40,50	6X4-42102-63-00
60, 70	6X4-42102-52-00
80, 90	6X4-42102-41-00

4 Stroke Fitting Kits

Application	Part Number
F20B	6X4-42102-K0-00
F25C PTT Models	6X4-42102-E0-00
F40B (Carburated)	6X4-42102-32-00
F30 / F40LA (EFI)	6X4-42102-71-00
F50, F60, F70	6X4-42102-23-00
F75, F90A	6X4-42102-12-00
F75,F90B/VF90	6X4-42102-J1-00
F115 / VF115	6X4-42102-02-00
F115B / VF115B	6X4-42102-H1-00

Cowling Covers

Super heavy-duty protection for your Yamaha outboard's cowling. Constructed of ultra-durable Sur Last® solution dyed polyester fabric for the ultimate protection against fading and the elements, this non-abrasive, water resistant cover is resistant to UV, mildew and mold. The cover has a soft fabric inner liner for added paint protection, and screened on factory logos for unmatched style. Includes a snap-buckle strap and stretch cord for a snug fit.

V8 Application	Engine Cover	Lining
5.6L XTO Offshore Outboards	MAR-MTRCV-RX-T0	Yes
5.3L V8 Outboards	MAR-MTRCV-11-V8	Yes

V6 Application	Engine Cover	Lining
4.2L Offshore Outboards	MAR-MTRCV-F4-2L	Yes
F250 Outboards	MAR-MTRCV-11-25	Yes
F225 Outboards	MAR-MTRCV-11-00	Yes
F200 Outboards	MAR-MTRCV-11-00	Yes

F40 ~ F15C Application	Engine Cover	Lining
F40 Outboards	MAR-MTRCV-11-40	No
F30 Outboards	MAR-MTRCV-11-30	No
F20 Outboards	MAR-MTRCV-11-15	No
F15C Outboards	MAR-MTRCV-11-15	No

F200 ~ F50 Application	Engine Cover	Lining
F200 (Inline) / F150B / F175	MAR-MTRCV-F2-01	Yes
F150A Outboards	MAR-MTRCV-1C-15	Yes
F115/F115B Outboards	MAR-MTRCV-11-50	No
F100 Outboards	MAR-MTRCV-11-50	No
F75/F90B Outboards	MAR-MTRCV-F9-0B	No
VF90 Outboards	MAR-MTRCV-VF-90	
F90 Outboards	MAR-MTRCV-11-50	No
F80 Outboards	MAR-MTRCV-11-50	No
F75 Outboards	MAR-MTRCV-11-50	No
F70 Outboards	MAR-MTRCV-FS-70	Yes
F/T50B / F/T60B	MAR-MTRCV-FS-70	Yes
T/F60 Outboards	MAR-MTRCV-11-80	No
T/F50 Outboards	MAR-MTRCV-11-30	No

Application	Engine Cover	Lining
V6 VMAX SHO® Outboards	MAR-MTRCV-ER-SH	Yes
150 VMAX SHO® Outboards	MAR-MTRCV-15-S1	Yes
VF115 VMAX SHO® Outboards	MAR-MTRCV-11-5S	No

V6 Application	Engine Cover	Lining
VMAX® HPD® 2.6L Outboards	MAR-MTRCV-11-10	Yes
VMAX® HPD® 3.3L Outboards	MAR-MTRCV-1M-30	Yes
P, V, VX, D, DX 2.6L VMAX® Outboards	MAR-MTRCV-11-V6	Yes
VX VMAX® 3.1L Outboards	MAR-MTRCV-1M-20	Yes

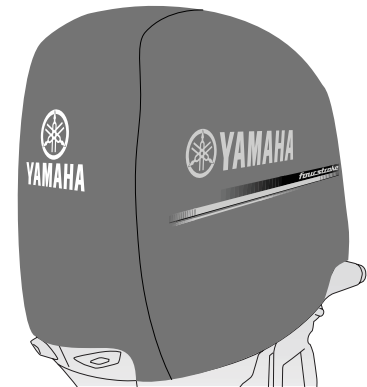

General Information

Rigging Estimate Guide (Diagrams)

Rigging Components

Electrical Components

Engine Accessories

Propellers

Maintenance Items

Oils & Lubes

Detailing & Trailer Supplies

Accessories & Apparel

Generators & Accessories

Engine Accessories

General Information

Rigging Estimate Guide (Diagrams)

Rigging Components

Electrical Components

Engine Accessories

Propellers

Maintenance Items

Oils & Lubes

Detailing & Trailer Supplies

Accessories & Apparel

Generators & Accessories



Application	Engine Cover	Lining
S, SX, L, LX 150-250 Outboards	MAR-MTRCV-11-SS	Yes

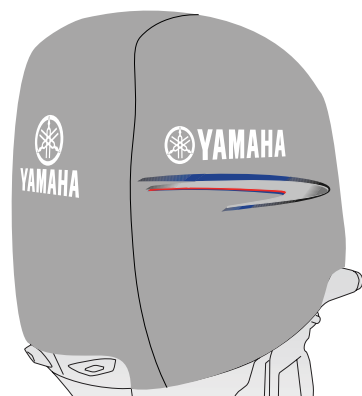

Application	Engine Cover	Lining
HPDI® 2.6L Outboards	MAR-MTRCV-11-11	Yes
HPDI® 3.1L Outboards	MAR-MTRCV-11-20	Yes

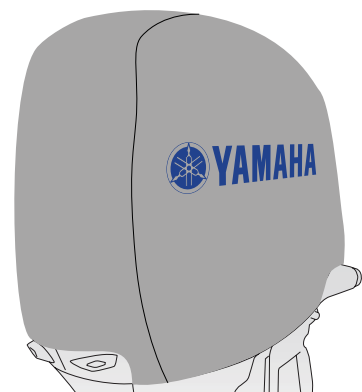

Application	Engine Cover	Lining
150 - 200 2 Stroke Outboards	MAR-MTRCV-ER-70	No
115 - 130 2 Stroke Outboards	MAR-MTRCV-ER-60	No
C75 - 90 2 Stroke Outboards	MAR-MTRCV-ER-40	No
30 - 70 2 Stroke Outboards	MAR-MTRCV-ER-20	No
6 - 25 2 Stroke Outboards	MAR-MTRCV-ER-10	No
F25C	MAR-MTRCV-F2-5C	No
F25 Outboards	MAR-MTRCV-ER-20	No
F4 - F15 Outboards	MAR-MTRCV-ER-10	No



Description	Cover
Tuning Fork Logo Spare Tire Cover	MAR-TIREC-OV-ER
Skeeter® Logo Spare Tire Cover	MAR-TIREC-OV-SK
Propeller Cover	MAR-PROPB-AG-BK

F9.9 / T9.9 (01/13~) Cowling with VMAX SHO® graphics

The top cowling allows both engines to have matching graphics in applications where a kicker motor is used along with a VMX SHO® V6 outboard. Fits 9.9hp engine with factory 6EA cowling.

6EA-42610-V0-00



Custom color cowling graphics

These graphics packages allow the customer to customize their motors to match the colors of their boat with ease. The current offerings are some of the most popular colors but further offerings can be purchased from: Universal Products, Inc. www.u-p.com. Contact them directly for color libraries as well as pricing.



	300	250	225
 Blue Metallic	MAR426KT2701	MAR426KT7001	MAR426KT7301
 Silver Metallic	MAR426KT2702	MAR426KT7002	MAR426KT7302
 Canary Yellow	MAR426KT2703	MAR426KT7003	MAR426KT7303
 Fire Red	MAR426KT2704	MAR426KT7004	MAR426KT7304
 Apple Green	MAR426KT2705	MAR426KT7005	MAR426KT7305
 Magnesium Metallic	MAR426KT2706	MAR426KT7006	MAR426KT7306
 Dark Bronze Metallic	MAR426KT2707	MAR426KT7007	MAR426KT7307
 Copper Metallic	MAR426KT2708	MAR426KT7008	MAR426KT7308

Engine Security



McGard® Outboard Lower Unit Lock Bolt

The lock is designed to secure the lower unit to the mid-section of the outboard while in storage, on the trailer, or in use. A free-spinning collar turns if attacked by gripping tools, helping protect against costly lower unit theft. Simply replace one of the standard lower unit mounting bolts with a McGard® lower unit locking bolt. Use the included special key to remove the McGard® lower unit locking bolt when removal of the lower unit is required. Stainless steel, through hardened construction. Fits Yamaha outboards F115 – F350 without 5" extension.

MAR-LWRUN-LK-00



McGard® Wheel Locks

McGard®'s easy to use, one-piece wheel lock functions like a regular lug nut, but requires a special key tool for installation and removal. Its design allows for an unlimited number of different computer generated lock and key patterns. This unique wheel lock system is continually being refined and improved upon. McGard® Locks are made right here in the United States to meet or exceed O.E.M. standards for safety and durability

Single Axle Trailer (2 locking nuts): **MAR-TRLK7-40-42**

Dual Axle Trailer (4 locking nuts): **MAR-TRLK7-40-41**



Prop Lock

Helps protect your propeller investment. Easy-to install and cost effective. Does not interfere with operation (i.e., motor can be used with a lock installed). Suitable for use on regular and counter rotating props.

115hp ~ V6 Outboards: **MAR-PRLK7-40-40**

40 ~ 90 Outboards: **MAR-PROPL-CK-01**

General Engine Accessories

Engine Mounting Bolts

Application	Length	Part Number
115 ~ 300; F80 ~ F250	70mm (2.75 in)	90101-12M37-00
115 ~ 300; F80 ~ F250	79mm (3.1 in)	90101-12014-00
115 ~ 300; F80 ~ F250	95mm (3.75 in)	90101-12M51-00
115 ~ 300; F80 ~ F250	105mm (4.1 in)	90101-12M65-00
115 ~ 300; F80 ~ F250	115mm (4.5 in)	90101-12M03-00
115 ~ 300; F80 ~ F250	130mm (5.1 in)	90101-12M05-00
115 ~ 300; F80 ~ F250	150mm (5.9 in)	90101-12047-00
V8 Outboards	85mm (3.35 in)	90101-12051-00V
V8 Outboards	110mm (4.3 in)	90101-12053-00
V8 Outboards	150mm (5.9 in)	90101-12031-00
V8 Outboards	170mm (6.7 in)	90101-12036-00
V8 Outboards	180mm (7 in)	90101-12054-00
V8 Outboards	200mm (7.9 in)	90101-12055-00
V8 Outboards	210mm (8.2 in)	90101-12056-00
V8 Outboards	230mm (9 in)	90101-12057-00



XTO Ram Tilt Motor Support

Trailer Motor Support with Yamaha Tuning Fork logo designed for XTO® only, requires two per engine.

MAR-MTSPT-GR-00

Trailer Support For Single Trim Ram Models

Designed to work with T25 - F115B.

MAR-MTSPT-SR-00



Trailer Support (Twin Trim Ram Models)

One Yamaha Motor Trailing Support will provide adequate support for the F115 ~ V6 four-stroke and all 70 ~ 300 two-stroke models while trailering. V8 models require two supports. The Yamaha Motor Trailing Support is quickly and easily installed over the port trim rod on F115 ~ F250 four-stroke and all 70 ~ 300 two-stroke models or both trim rods on the V8 models. Fits F115~F350 Four-Stroke and all 70~300 Two-Stroke models with Power Trim and Tilt. Does Not work with new F115B.

MAR-MTSPT-YM-10



Yamaha Transom plate

A great way to add style and show off your Yamaha Pride. Laser Etched with the Yamaha Logo.

F30A ~ V6,V4 outboards: **YMM-09TP0-00-01**

V8 outboards: **YMM-09TP0-00-02**



General Information

Rigging Estimate Guide (Diagrams)

Rigging Components

Electrical Components

Engine Accessories

Propellers

Maintenance Items

Oils & Lubes

Detailing & Trailer Supplies

Accessories & Apparel

Generators & Accessories

Engine Flushers

Connects in seconds to a common garden hose to flush out harmful sand, salt, and other contaminants.



Application	Part Number
VZ225, VZ250, VZ300, V-MAX SHO®	MAR-FLUSH-ER-VF
3, 4, 5, 9.9, FT9.9, 15 and all jet drive	ABB-FLUSH-JD-00
6, 8, 25-Z300HP	ABB-MOTOR-FL-SH

Tilt Limiters

The tilt limiter for the new Yamaha Outboards was introduced to assist in customer satisfaction. The new limiter will help improve customer satisfaction in applications where the top cowling would come in contact with the boat at full tilt. Please select the correct tilt limiter from the charts below.

Tilt Limiter for Mechanical Controlled F115, F150, F200 (inline) & VMAX SHO® Outboards

Model	Serial Number Range	Part Number
F115 / F115B / VF115	68V 1124466~	63P-825EY-02-00
LF115 / LF115B	68W 1005001~	63P-825EY-02-00
F150 / VF150 / F175 / VF175	63P 1106291~	63P-825EY-02-00
LF150	64P 1013389~	63P-825EY-02-00
VF200	6CD 1000832~	63P-825EY-02-00
VF225	6CC 1001056~	63P-825EY-02-00
VF250	6CB 1002436~	63P-825EY-02-00

Tilt Limiter for DEC Controlled 4.2L Offshore Outboards & F200 (inline) DEC Outboards

Model	Production Date Range	Part Number
F200 (inline) / F225	01/2012 ~	6CE-825EY-01-00
F250	01/2012 ~	6CE-825EY-01-00
F300	01/2012 ~	6CE-825EY-01-00

Tilt Limiter for F75, F90 Outboards

Model	Production Date Range	Part Number
F75	01/2012~	6D8-825EY-01-00
F90	01/2012~	6D8-825EY-01-00

Tilt Limiter for F50, T50, F60, T60, F70 Outboards

Model	Production Date Range	Part Number
F50	04/2012~	6C5-825EY-00-00
F60	04/2012~	6C5-825EY-00-00
F70	04/2012~	6C5-825EY-00-00



XTO Offshore V8 Models Automatic Flushing System

Connects in seconds to flush out harmful sand, salt, and other contaminants.

Application	Part Number
Twin Engine Automatic Flushing System	MAR-FLUSH-20-00
Twin Engine Fitting Kit	MAR-FLSHF-T2-00
Triple Engine Automatic Flushing System	MAR-FLUSH-30-00
Triple Engine Fitting Kit	MAR-FLSHF-T3-00
Quad Engine Automatic Flushing System	MAR-FLUSH-40-00
Quad Engine Fittings Kit	MAR-FLSHF-T4-00

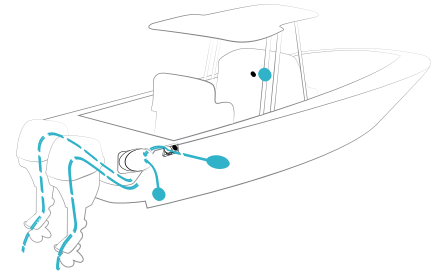

XTO Offshore Flushing Installation Components

Component	Part Number
Remote Switch w/ 3' Harness Assembly	MAR-FLSHS-W3-00
Remote Switch w/ 9' Harness Assembly	MAR-FLSHS--W9-00
Remote Switch w/ 15' Harness Assembly	MAR-FLSHS-W1-50
Remote Switch w/ 19' Harness Assembly	MAR-FLSHS-W1-90
Inlet Hose Install Kit - 3'	MAR-FLSHH-S3-00
Inlet Hose Install Kit - 6'	MAR-FLSHH-S6-00
Inlet Hose Intall Kit - 9'	MAR-FLSHH-S9-00
Quick Disconnect Deck Kit with 1/2" MNPT x 3/4" Hose Barb Straight Fitting	MAR-FLSHQ-D0-00
Quick Disconnect Deck Kit with 1/2" MNPT x 3/4" Hose Barb 90 degree Elbow	MAR-FLSHQ-D9-00
Quick Disconnect Mounting Kit - Standard	MAR-FLSQD-KS-00
Quick Disconnect Mounting Kit - 90 Degree Turn	MAR-FLSQD-K9-00
Quick Disconnect Mounting Kit - 180 Degree Turn	MAR-FLSQD-K1-80
Quick Disconnect Mounting Kit - 270 Degree Turn	MAR-FLSQD-K2-70
Quick Disconnect Mounting Kit - No Switch	MAR-FLSQD-K0-00
1/2" ID Bulk Flushing Hose 25' Roll	MAR-FLSHH-S2-50

General Information

Rigging Estimate Guide (Diagram)

Rigging Components

Electrical Components

Engine Accessories

Propellers

Maintenance Items

Oils & Lubes

Detailing & Trailer Supplies

Accessories & Apparel

Generators & Accessories



Description	Page
Propeller Quick Reference Chart	6-1
Propeller Cross Reference Chart	6-3
Yamaha Propeller Descriptions	6-5
Turbo Propeller Descriptions	6-9
How to Pick a Propeller	6-12
Propeller Terminology	6-13
Propellers for 2-Stroke 2-15, and 4-Stroke F2.5-F20	6-16
F Series Propellers for 3.0" Gearcases	6-17
G Series Propellers for 3.5" Gearcases	6-17
K Series Propellers for 4.25" Gearcases	6-18
M or T Series Propellers for 4.75" Gearcases	6-20
X Series Propellers for 5.25" Gearcases	6-24
Small Hub Propellers for High Performance Applications	6-26
TRP (Twin Rotating Propellers) for TRP Gearcases	6-26
Turbo Propellers for 3.0" Gearcases (<i>F Series</i>)	6-27
Turbo Propellers for 3.5" Gearcases (<i>G Series</i>)	6-27
Turbo Propellers for 4.25" Gearcases (<i>K Series</i>)	6-28
Turbo Propellers for 4.75" Gearcases (<i>M or T Series</i>)	6-29
Hubs for Yamaha Propellers	6-34
Hubs for Turbo Propellers	6-35
Turbo Hub Application Charts	6-36
Propeller Hardware Kits	6-45
Propeller Accessories	6-46



Propeller Quick Reference Chart

With all that Yamaha has to offer in regard to propellers, virtually any boat can perform at its peak. That includes your customers. From large offshore boats to family and watersports boats to the fastest of bass and bay boats, Yamaha has a propeller solution that's just right for your customers' application. Yamaha propeller solutions. Well beyond expectations.

RH F25 and 20-30 (3.0" Gearcase)	RH T25, F30-F60 and 40-55 (3.5" Gearcase)	RH T50, T60, F70-F115 and C60-130 (4.25" Gearcase)	LH T50, T60, F70-F115 and C60-130 (4.25" Gearcase)	RH 150-300 and F150 - F300 (V6) (4.75" Gearcase)	LH 150-300 and F150 - F300 (V6) (4.75" Gearcase)	RH V8 (5.25" Gearcase)	LH V8 (5.25" Gearcase)
----------------------------------	---	--	--	--	--	------------------------	------------------------

Propeller Series	Recommended Boat Application	Yamaha Propeller Available Pitches							
		8-14	8-17	11-25	14-20	15-23	17-21	18-26	21-23
Aluminum	Family, Water Sports, Medium, and Small Boats	8-14	8-17	11-25		15-23			
Talon®	Medium and Small Boats			9-16					
Talon® SS	Medium and Small Boats			14-24	14-20				
Talon® GP	Medium and Small Boats			14-18					
Talon® SS4	Medium and Small Boats			14-23					
Talon® Pontoon	Family, Water Sports, Medium, and Small Boats			9-13					
Dual Thrust	Family and Water Sports	8 1/4	9	11					
Painted Stainless Steel	Family, Water Sports, Medium, and Small Boats		11-16	14-23	17-21	13-23	15-23		
Performance 3	Family, Water Sports, Medium, and Small Boats	10-14	12-15	14-24	14-22	14-26	14-22		
Performance 4	Bass, Bay, and Flats Boats					18-26			
Performance XT	Bass, Bay, and Flats Boats					23-27			
Saltwater Series XL4	Large Boats							15-17	15-17
Saltwater Series XL4-HP	Large Boats							22-24	22-24
PRO	Bass, Bay, and Flats Boats					21-27			
Reliance® SDS	Family, Water Sports, Medium, and Small Boats					13-21	14-21		
Saltwater Series HS4-SDS	Large Boats					21-23	21-23		
Saltwater Series II - SDS	Family, Water Sports, and Large Boats					13-23	13-23		
Saltwater Series XL® - SDS	Large Boats							15-23	15-23
V MAX SHO® (ventless)	Bass, Bay, and Flats Boats					22-29			
Weedless	Medium and Small Boats	12-13							

Propeller Series	Recommended Boat Application	Turbo Propeller Available Pitches					
Fusion 4	Bass, Bay, Flats, and Large Boats					21-26	21-23
FX4	Bass, Bay, Flats, Medium, and Small Boats			14-25			
FXP™	Bass, Bay, and Flats Boats					22-27	
Hot Shot	Medium and Small Boats	10-15	10-19				
Lightning	Bass, Bay, and Flats Boats					17-21	
Offshore 1	Bass, Bay, Flats, and Larger Boats					15-26	15-26
Offshore 2	Large Boats					15-25	15-25
Pontoon 1	Family, Water Sports, Medium, and Small Boats		9-15	9-15			
Quest™ 3 Blade	Family, Water Sports, Medium, and Small Boats			15-21			
Quest™ 4 Blade	Family, Water Sports, Medium, and Small Boats			14-21			
Turbo 1	Family, Water Sports, Medium, and Small Boats			13-23		13-25	15-21
Turbo 2+2	Bass, Bay, and Flats Boats					16-24	
Turbo 2+2OT						18-26	
TXP™	Bass, Bay, and Flats Boats					21-31	
TXP OT4	Bass, Bay, and Flats Boats					23-31	
Ultima 4	Bass, Bay, Flats, Medium, and Small Boats					13-23	13-23
Vector	Family and Water Sports					21-25	21-25

RH F25 and 20-30 (3.0" Gearcase)
RH T25, F30-F60 and 40-55 (3.5" Gearcase)
RH T50, T60, F70-F115 and C60-130 (4.25" Gearcase)
RH T50, T60, F70-F115 and C60-130 (4.25" Gearcase)
LH T50, T60, F70-F115 and C60-130 (4.25" Gearcase)
RH 150-300 and F150 - F300 (V6) (4.75" Gearcase)
LH 150-300 and F150 - F300 (V6) (4.75" Gearcase)

- General Information
- Rigging Estimate Guide (Diagrams)
- Rigging Components
- Electrical Components
- Engine Accessories
- Propellers**
- Maintenance Items
- Oils & Lubes
- Detailing & Trailer Supplies
- Accessories & Apparel
- Generators & Accessories

Propeller Cross Reference Chart

GEARCASE	YAMAHA	TURBO	MERCURY®	Quicksilver®	BRP®
F (3.0")	Aluminum	N/A	Black Max®	Black Diamond®	Aluminum
	Performance 3	Hot Shot	Vengeance®	Silverado®	SSP
G (3.5")	Aluminum	N/A	Black Max®	Black Diamond®	Aluminum
	Performance 3	Hot Shot	Vengeance®	Silverado®	SSP
	Painted Stainless	N/A	N/A	N/A	N/A
K (4.25")	Aluminum	N/A	Black Max®	Black Diamond®	Aluminum
	Painted Stainless	Quest	Vengeance®	Silverado®	SSP
	Pro Series	Turbo 1	Laser II Vengeance®	Lightspeed® Silverado®	SSP Raker®
	Talon® SS (SDS)	Turbo 1	Laser II Vengeance®	Lightspeed® Silverado®	SSP Raker®
	Talon® SS4 (SDS)	FX4	Trophy® Plus Spitfire	Nemesis (aluminum)	Rogue
	Talon® Pontoon	Pontoon 1	Black Max® XC (aluminum)	Nemesis Pontoon (aluminum)	Hydrus® (aluminum)
M/T (4.75")	Aluminum	N/A	Black Max®	Black Diamond®	Aluminum
	Painted Stainless	N/A	N/A	N/A	N/A
	Performance 3 (SDS)	Turbo 1	Laser II Vengeance®	Silverado®	SSP Viper
	Performance XT	Lightning	Tempest® Fury®	Torrent®	Raker® II
	VMAX vented	TXP	Tempest® Fury®	Torrent®	Raker® II
	VMAX SHO® (ventless)	FXP	Tempest® Fury®	Torrent®	Raker® II
	Pro Series™	Lightning	Laser II Vengeance®	Lightspeed®	SSP Viper
	Performance 4 (SDS)	2+2 OT-Bass 2+2 TH-others	Trophy® Plus Vensura®	Nemesis	Cyclone
	Reliance® (SDS)	Turbo 1	Laser II Vengeance®	Silverado®	SSP Viper
	Saltwater Series II™ (SDS)	Offshore II Vector	Mirage® Plus	Thunderbolt®	Rebel®
	HS4™ (SDS)	Offshore I Fusion	Bravo 1® Revolution 4®	Q4	Cyclone

This document is for your dealership's use only and should not be copied, disseminated or disclosed without prior written permission of Yamaha. This is to be used as a guideline only to assist sales personnel in the comparison of competitive propeller models as compared to Turbo propellers. This is a guideline only as there are many factors that go into choosing the correct propeller. Turbo propellers are manufactured by Yamaha Marine Precision Propellers, Inc. a wholly owned subsidiary of Yamaha.

GEARCASE	YAMAHA	TURBO	Solas®	Michigan Wheel®	POWERTECH
F (3.0")	Aluminum	N/A	Amita 3	Michigan Match® Votex XHS	Aluminum Series B
	Performance 3	Hot Shot	New Saturn	Ballistic®	SRA3
G (3.5")	Aluminum	N/A	Amita 3	Michigan Match® Votex XHS	Aluminum Series C
	Performance 3	Hot Shot	New Saturn	Ballistic® Apollo® std.	SRD3 SRC3 REB3
	Painted Stainless	N/A	New Saturn	Apollo® std.	SCB3
K (4.25")	Aluminum	N/A	Amita 3	Michigan Match® Votex XHS	Aluminum Series D
	Painted Stainless	Quest	New Saturn	Ballistic® Apollo® std.	MQF3 SCD3
	Pro Series	Turbo 1	Titan	Ballistic® XL Apollo® std.	PTR3
	Talon® SS (SDS)	Turbo 1	Titan	Ballistic® Apollo® std.	RED3
	Performance 4 Talon SS4 (SDS)	FX4	HR Titan 4	Ballistic® XL Apollo® 4 Blade	RXB4
	Talon® Pontoon	Pontoon 1	New Saturn	Michigan Match® / Vortex XHS / Apollo® LG DIA	WBH3
M/T (4.75")	Aluminum	N/A	Amita 3	Michigan Match® Votex XHS	Aluminum Series E
	Painted Stainless	N/A	New Saturn	Ballistic® / Apollo® std. Apollo® 1g dia.	SCE3
	Performance 3 (SDS)	Turbo 1	HR Titan 3	Ballistic® Apollo® std.	PTC3
	Performance XT	Lightning	HR Titan 3	Ballistic® XL	PTC3
	VMAX vented	TXP	HR Titan 3	Ballistic® Apollo® std.	VMX3
	VMAX SHO® (ventless)	FXP	HR Titan 3	Ballistic® Apollo® std.	VMX3
	Pro Series™	Lightning	HR Titan 3	Ballistic® XL / Apollo® std. Apollo® 1g dia.	PTC3
	Performance 4 (SDS)	2+2 OT-Bass 2+2 TH-others	HR Titan 4	Ballistic® XL Apollo® 4 Blade	TRO4
	Reliance® (SDS)	Turbo 1	New Saturn	Ballistic® / Apollo® std. Apollo® 1g dia.	SFS3
	Saltwater Series II™ (SDS)	Offshore II Vector	Lexor®	Ballistic® / Apollo® std. Apollo® 1g dia.	OFS3
	HS4 (SDS)	Offshore I Fusion	HR Titan 4	Ballistic® XL Apollo® 4	OFS4

General
Information

Rigging Estimate
Guide (Diagrams)

Rigging
Components

Electrical
Components

Engine
Accessories

Propellers

Maintenance
Items

Oils
& Lubes

Detailing &
Trailer Supplies

Accessories
& Apparel

Generators
& Accessories

Yamaha Propeller Descriptions

Endless Propeller Solutions By Yamaha

With all that Yamaha has to offer in regard to propellers, virtually any boat can perform at its peak. That includes yours. From large offshore boats to family and watersports boats to the fastest of bass and bay boats, Yamaha has a propeller solution that's just right for your application. Yamaha propeller solutions. Well beyond expectations.



Plastic Propellers

- Ideal for those who run in debris filled water.
- Available for the 2 HP two stroke or the T9.9 four stroke.



Aluminum

- Low cost
- Lightweight
- Good all around performance
- Wide variety of applications 2hp - 225hp



Dual Thrust™

- Large diameter and large blade design
- Low pitch and rake angle
- Large oversized exhaust tube to redirect exhaust in reverse for better reverse thrust
- Perfect for sailboats and pontoons
- Designed for Yamaha High Thrust outboards and also works well on midrange outboards using the "K" series (4.25") gearcase



Weedless Propellers

- Designed to help keep vegetation off your propeller and prop shaft.
- Propellers with a 91/4 diameter are available in the Aluminum Series
- 91/8 diameter weedless design available in painted stainless steel.



Painted Stainless Steel

- Excellent general purpose propeller
- More durable than aluminum
- Wide variety of applications from 25hp - 300hp in left and right-hand rotation

Talon®

- Shift Dampener System (SDS™)
- High efficiency, low slip design
- Lightweight aluminum
- Excellent for Pontoon, Deep V, Walleye, and Fiberglass boats
- Available in 9", 10.5", 12", 14", and 16" pitches



Talon® SS

- Shift Dampener System (SDS™)
- High efficiency, low slip design
- Excellent for light bass, flats, and small to medium boats with mid-range power
- Available in 14", 16", 18", 20" in left and right-hand rotation
- Available in 19", 22", 24" right-hand rotation



Talon® GP

- Special blades provide excellent "grip" on the water
- Ideal for a variety of lighter weight boats using T50-F115 outboards
- Shift Dampener System (SDS™)
- Available in 14" – 18" pitches



Talon® Pontoon

- Excellent for use with 4.25" gearcases.
- Use on twin-log pontoon boats and some deck boats, sailboats, and utility/work boats where extra thrust, maneuverability, and control are needed.
- Ideal for many applications using Yamaha's F70 outboard.
- Resists ventilation, particularly in turns and at high engine trim levels



Talon® SS4

- Special blades provide excellent "grip" on the water
- Ideal for a variety of lighter weight boats using T50-F115 outboards
- Shift Dampener System (SDS™)
- Available in 14" – 23" pitches



Performance 3

- Shift Dampener System (SDS™) M/T Series
- Excellent general purpose propeller
- More durable than aluminum
- Wide variety of applications from 25hp - 300hp in left and right-hand rotation



General Information

Rigging Estimate Guide (Diagrams)

Rigging Components

Electrical Components

Engine Accessories

Propellers

Maintenance Items

Oils & Lubes

Detailing & Trailer Supplies

Accessories & Apparel

Generators & Accessories

Propellers

General Information

Rigging Estimate Guide (Diagrams)

Rigging Components

Electrical Components

Engine Accessories

Propellers

Maintenance Items

Oils & Lubes

Detailing & Trailer Supplies

Accessories & Apparel

Generators & Accessories



PRO™

- Excellent performance choice for bass, bay, or flats boats
- Improved bow lift
- Vented exhaust
- Available for Yamaha "M" series (4.75") gearcases



Reliance®

- Shift Dampener System (SDS™)
- CAD-designed to increase performance
- Resists ventilation and improves overall grip
- Designed for Yamaha 2.7L and 2.8L inline four cylinder outboards (F150 ~ F200)



Performance 4

- Improved hole shot and overall grip
- Excellent in rough water or on applications requiring high engine mounting heights
- "M" series (4.75") gearcases, 150-225hp



V MAX SHO®

- Ultimate performance for V MAX SHO® four stroke outboards
- Excellent for bass, bay, and flats boats
- Awesome acceleration and top speed
- Ventless exhaust
- Incredible performance and handling
- Available in 22"- 27" pitches right-hand rotation only



Saltwater Series HS4™

- Shift Dampener System (SDS™)
- Excellent acceleration, quick planing, and maximum grip
- Resists ventilation in rough or following seas
- Designed for Yamaha V6 outboards
- Available in 21", 22", and 23" pitches in left and right-hand rotation



Saltwater Series II™

- Shift Dampener System (SDS™)
- Large diameter blade design
- Aggressive rake and extra cup
- Superior fuel efficiency
- Available for Yamaha "M" and "T" series (4.75") gearcases in select 13" - 23" pitches in left and right-hand rotation

Performance XT™

- Large, long blade design
- Increased strength and durability
- Perfect for heavier bass boats with jack plates or high engine mounting height
- Available in 17"-27" pitches, right-hand rotation only



Saltwater Series XL®

- Shift Dampener System (SDS™)
- Designed specifically for Yamaha V8 outboards
- Large blade and large diameter for maximum thrust
- Excellent acceleration and quick planing
- Available in select 15" - 23" pitches in left and right-hand rotation for Yamaha "X" series (5.25") gearcases



Saltwater Series XL4™

- Shift Dampener System (SDS™)
- Improved acceleration and grip
- Quick planing and reduced ventilation
- Excellent for large V8 powered offshore boats
- Available in 15" and 17" pitches in left and right-hand rotation



Saltwater Series XL4™ - HP

- Shift Dampener System (SDS™)
- Improved acceleration and grip
- Quick planing, advanced blade designed specifically for Yamaha V8 outboards
- Excels on stepped hull, high speed, high horsepower offshore center console boats
- Available in 22" and 24" pitches in left and right-hand rotation



TRP

- 60% more blade surface provides transom lifting performance like no other.
- Outstanding handling, greater thrust and unmatched hole shot.
- Requires a TRP (Twin Rotating Propeller Lower Unit)



Small Hub Series

- Highly-specialized propeller designed for specific applications using 60hp – 200hp outboards
- Features a "exhaust-over-the-hub" design, allowing the outboard to develop rpm quicker for faster hole shots.



General Information

Rigging Estimate Guide (Diagrams)

Rigging Components

Electrical Components

Engine Accessories

Propellers

Maintenance Items

Oils & Lubes

Detailing & Trailer Supplies

Accessories & Apparel

Generators & Accessories

Turbo Propeller Descriptions



2+2 TH

- Excellent sterndrive and V6 four-stroke outboard propeller
- Advanced blade geometry helps maximize performance on deeply submerged drive units
- Improved hole shot, acceleration and ability to effectively power heavier loads than typical three-bladed propellers
- Ideal for water sports or family boating



2+2 OT

- Over and thru hub exhaust
- Better acceleration and grip
- Excellent load carrying ability
- Fits a wide variety of V6 outboard applications



Fusion 4

- Advanced design with aggressive rake, progressive pitch
- Through hub vented exhaust
- Excellent for high horsepower sterndrive and outboard “surfacing” applications in single or multi engine configurations
- Excels on stepped hull offshore boats



FX4

- Improved bow and stern lift
- Improved acceleration and load carting ability
- Excellent for flats or shallow water boats
- Works well on a broad range of smaller boats and applications using 3 and 4 cylinder outboards with 4.25”gearcases



FXP™

- Designed specifically for ultra-high-performance four-stroke outboards like Yamaha’s V MAX SHO®
- Excels in hole shot, acceleration, top speed and handling; all at tournament loads
- Minimal bow rise, steering torque, and operator fatigue
- Excellent for light, high performance bass, bay and flats boats
- Available in single inch pitches from 22” to 27”



Hot Shot

- Ideal for smaller boats and outboards
- Reduced slip and resistance to ventilation
- Increased performance and fuel efficiency
- Increased durability over aluminum

Lightning

- Aggressive pitch, high rake angle, and large diameter
- Excellent speed, handling, and bow lift
- Thick blades increase strength, longevity, and durability
- Ideal for heavier designed bass and flats boats with high engine mounting heights
- Designed for Yamaha V6, MERCURY®®, Johnson®/Evinrude® V6/
V8, and Suzuki®



Offshore I & II

- Excellent for 200HP - 300HP V6 offshore-type applications in single or multiple engine configurations
- Offshore I = 4-blade design / Offshore II = 3-blade design
- Superlative load carrying ability, transom & bow lift for large heavy offshore boats using outboard power
- Outstanding speed and fuel efficiency at cruising RPM's
- Reduced ventilation and slip in rough or following seas



Pontoon 1

- Excellent for use with 3 and 4 cylinder outboards with 3.5" or 4.25" gearcases
- Use on twin-log pontoon boats and some deck boats, sailboats, and utility/work boats where extra thrust, maneuverability, and control are needed.
- Ideal for many applications using Yamaha's F70 outboard.
- Resists ventilation, particularly in turns and at high engine trim levels



Quest™

- Excellent for 3 and 4 cylinder outboards using a 4.25" gearcase
- Very well suited for smaller utility/work boats and Yamaha F70 applications
- Available with 3 or 4 blades



Turbo 1

- Turbo's most popular and best "all around" performance propeller
- Suitable for most 3 and 4 cylinder outboards and V4/V6 outboards, as well as stern drives and Johnson®/Evinrude® V8 outboards
- Enhanced bow lift, excellent performance, and handling characteristics for medium to heavily loaded boats



General Information

Rigging Estimate Guide (Diagrams)

Rigging Components

Electrical Components

Engine Accessories

Propellers

Maintenance Items

Oils & Lubes

Detailing & Trailer Supplies

Accessories & Apparel

Generators & Accessories

Propellers

General Information

Rigging Estimate Guide (Diagrams)

Rigging Components

Electrical Components

Engine Accessories

Propellers

Maintenance Items

Oils & Lubes

Detailing & Trailer Supplies

Accessories & Apparel

Generators & Accessories



TXP™

- Excellent high-horsepower, high-speed propeller for very light, high-speed boats, particularly those using high engine mounting heights or a hydraulic jack plate and having naturally greater bow lift “built-in”
- Aggressive pitch and cupping
- High rake angle
- Excellent for surface piercing applications



TXP™ OT4

- Excellent high-horsepower, high-speed propeller for very light, high-speed boats, particularly those using high engine mounting heights or a hydraulic jack plate and having naturally greater bow lift “built-in”
- Faster hole shots and quicker acceleration
- Over and thru hub exhaust helps develop rpm rapidly
- Very aggressive pitch and high rake angle
- Large diameter and advanced trailing edge blade cupping
- Excellent in surface piercing applications



Ultima 4

- Suitable for V6 outboards utilizing a high engine mounting or operating height, including those with jack plates
- Excellent for bay and flats boats due to stern lift at hole shot and during acceleration
- Excellent performance with improved bow and transom lift
- Resists ventilation and slip in turns and at high engine trim levels



Vector

- Specifically for sterndrives where the props ride fully submerged
- Also works well on heavier 22’-27’ boats, particularly with twin engines
- Faster hole shots and improved planing
- Excellent bow lifting characteristics
- Good performance in rough water

What does the Yamaha propeller series mean?

The propeller series simply relates to the gearcase diameter. See the chart below for more information.

Propeller Mark	Model	Gear Case Diameter	Spline Count
A	2	1.75"	Shear Pin, no Spline
BS	F2.5	2.00"	9
B	4, 5	2.00"	9
BA	4, 5, F4, F4A, F6A	2.00"	9
N	6, 8, F6, F8	2.25"	7
R	T8, T9.9	2.50"	8
J	9.9 ~ F20	2.50"	8
F	20~30, F25	3.00"	10
G	40~55, T25~F60	3.50"	13
K, KL	60~130, T50~F115	4.25"	15
M/T, ML/TL	150~300, F150 ~ F300 (4.2L V6)	4.75"	15
X, XL	F300/F350TR (V8)	5.25"	17

How to Pick a Propeller

When it comes to 'proper propping', there's no magic bullet or one particular prop that's perfect for all boat types and engine applications due to the litany of performance variables, but there are ways to 'hone in' on what you need. As a general rule, the correct propeller will allow your engine to reach the upper portion of the WOT (wide open throttle) range specified by the manufacturer without exceeding it, with a normal-to-heavy load. For example, if your outboard says WOT is 5000-6000 rpm, you need a prop that will allow your engine to turn between approximately 5700 and 6000 rpm with your average-to-heavy load in the boat. Be sure to account for things like fuel, full bait and/or live wells, batteries, passengers, and all gear, including safety gear like anchors, ropes, etc.

To begin, check Yamaha's Performance Bulletins on our website: <http://yamahaoutboards.com/owner-resources/performance-bulletins>.

Choose the type of boat most similar to yours (or the one you want), and note what propeller is listed. Next, check out the propeller solutions applicable to your particular horsepower Yamaha outboard in our propeller charts located in the propellers section of our marine website's landing page <https://yamahaoutboards.com/en-us/home/propellers/all/propeller-families> (there's a great deal of other great information in here, too!). Look for the same series name and pitch of propeller as the Performance Bulletin, then adjust the pitch depending on weight and altitude (heavier weight or higher altitude, pitch down...light or low, pitch even or slightly up). Each inch of propeller pitch is equal to approximately 150-200 rpm.

Don't see a Performance Bulletin for the same type boat as what you've got? Look on the outside barrel for the pitch or remove the prop and look on the inside of the hub for the propeller 'size', then consult the charts and adjust the pitch accordingly.

Yamaha Performance Bulletin

YPB#: PB_G3B_AnglerV167C_F60TLR_6-17-08_ALM

Test Date: 6/17/08



G3 Boats Angler V 167 C

Length	16'
Beam	6' 5"
Dry Weight (Boat Mfr. Published)	820 lbs.
Maximum HP	60 hp
Fuel Capacity	13 gals.
Weight as Tested (Approximate)	1,650 lbs.



Boat Manufactured By:
G3 Boats • 991 Cowan Drive • Lebanon, MO 65536
(417) 588-9797 • www.g3boats.com

Yamaha F60TLR

Horsepower	60
Displacement	60.8 cu. in.
Weight (Catalog Published)	237 lbs.
Gear Ratio	1.85

Engine Mounting Height

Mounting Hole Position	#2
------------------------	----

Propeller

Series	Aluminum Series
Diameter/Pitch	10-3/8 x 13
Yamaha Part #	6H5-45945-00-EL
Propeller Material	Aluminum

Test Conditions

Number of People	2
Air / Water Temperature (Fahrenheit)	82° / 72°
Elevation	924'
Wind Velocity	0-5 MPH

Comments: Test weight includes 1/2 tank of fuel, two batteries, bow-mounted trolling motor, safety and test equipment. Fuel consumption data gathered with Yamaha Command Link® fuel management system. Speed data gathered with GPS receiver.

Notice to Consumer: The information and data contained in this Performance Bulletin is approximate and subject to many different factors and variables. It is provided as a guideline only and should not be relied upon as representative of actual performance. Your boat's performance may be different than the information contained in this Performance Bulletin due to various factors, including your boat's actual weight, wind and water conditions, temperature, humidity, elevation, bottom paint, boat options affecting wind/water drag and/or boat weight, and operator ability. Please confirm the specifications and performance data on your specific boat/engine combination with your dealer prior to purchase. Yamaha reserves the right to change the specifications and performance data of this Performance Bulletin or engine without notice.

Performance Data

RPM	MPH	GPH	MPG
1000	3.2	0.4	8.00
1500	4.6	0.6	7.67
2000	5.9	0.9	6.56
2500	7.2	1.3	5.54
3000	11.4	1.7	6.71
3500	16.8	1.8	9.33
4000	22.0	2.3	9.57
4500	26.1	2.9	9.00
5000	29.4	3.5	8.40
5500	33.1	4.4	7.52
6000	36.1	5.4	6.69

Seconds to Plane

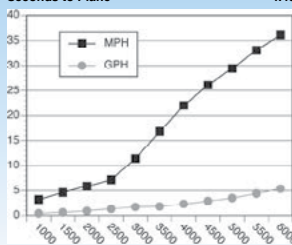

Test performed and verified by Yamaha Application Engineers.

For More Information:
Yamaha Motor Corp., USA • DEM Division, Marine Group
1270 Chastain Road NW • Kennesaw, GA 30144 • (800) 88-YAMAHA
For other Performance Bulletins, visit www.yamaha-motor.com.

Propeller Terminology

Pitch

Pitch is the distance (in inches) a particular prop would theoretically travel in one full revolution, as if traveling through a solid. A lower pitch will have better hole shot and “pushing power” but a lower top speed, while a higher pitch prop will provide less acceleration, but a greater potential for higher top speeds. The correct propeller will allow your engine to reach the upper portion of the WOT range specified by the manufacturer with a normal-to-heavy load (without exceeding it). Each inch of pitch is equal to approximately 150 +/- 50 RPM.

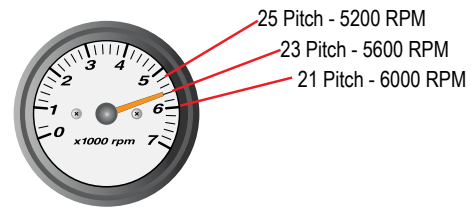

Diameter

Diameter means the total width of the “circle” at the blade tips as the propeller spins. A larger diameter pushes more water and reaches deeper into the water, so they’re typically used on large, heavy boats or ones with high engine mounting heights. A smaller diameter is usually used on lighter weight boats, where the prop operates lower in the water or when a gain in engine RPM is desired.

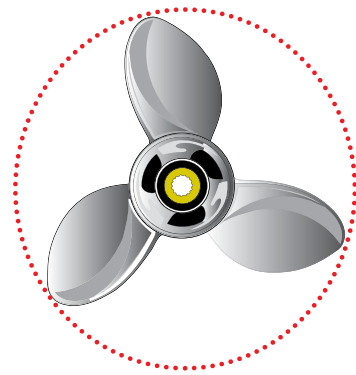

Number of Blades

Three-bladed propellers are the most common, offering good overall performance, top speed, and efficiency for most applications. Four blades characteristically provide increased acceleration, enhanced bow- and stern-lift, and reduced ventilation. However, four blades typically mean more drag on the engine, resulting in lower top speeds and different handling characteristics.

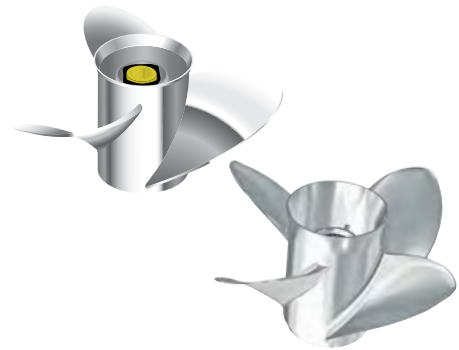

Blade Surface Area

Blade surface area refers to the total surface of the blades. The more blade surface area a prop has the more water it pushes, for better hole shot and increased planing efficiency. Too much can create significantly more drag, however, potentially restricting engine RPM and causing negative boat-handling issues.

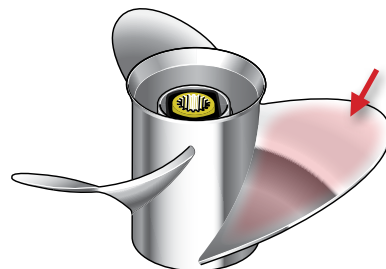

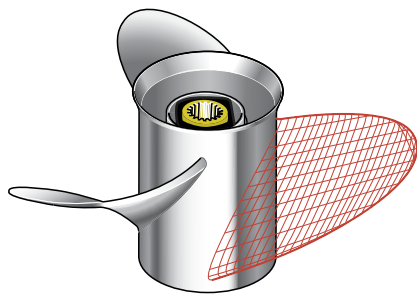

Blade Geometry

Blade geometry refers to the actual shape of the blade (or ear). By manipulating the blade's shape, diameter and pitch progression, different performance characteristics are created for each different type and style of propeller.

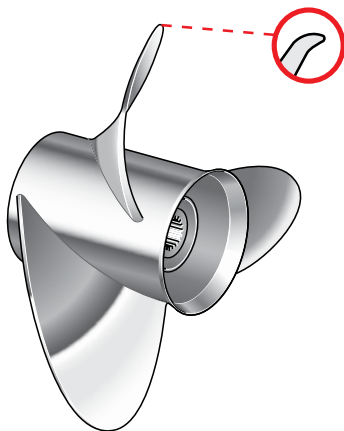

Cup

Cup is the small curved lip on the blade tip and/or trailing edge. Used in proper amounts, cup helps reduce ventilation and propeller slippage, allowing for higher mounting heights and greater bow lift. Too much cup, however, will cause excessive steering torque and bow lift and limit the engine's ability to develop and maintain proper RPM at a certain pitch.

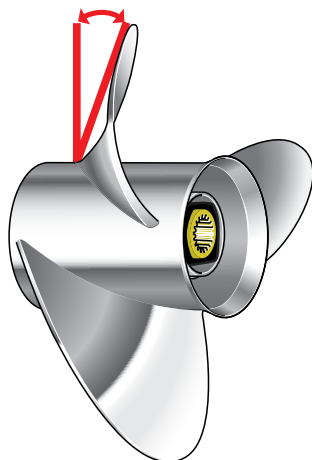

Rake

Rake is the angle of the blades in relation to the propeller's barrel, or center, and is expressed in degrees. A high rake propeller is best suited for high engine mount applications by helping reduce ventilation and increasing bow lift. Too much rake, however, strains the engine, decreases hole shot and can produce negative performance and handling results. A propeller with a low rake angle will cause less strain on the engine, resulting in potentially better hole shot and higher WOT operating rpm.

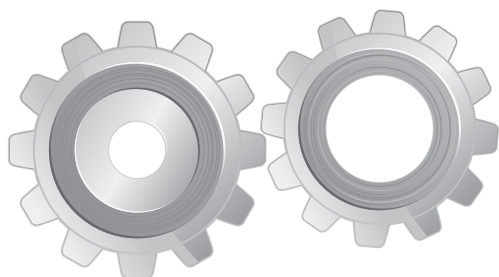

Gear Ratio

Gear ratio on a marine engine refers to the gears used in the lower unit, much like an automobile's transmission. The higher the ratio, the more pushing power the engine will produce. The lower the ratio, the more top speed the engine can potentially generate. It's important to choose a propeller that allows the engine to operate near the upper end of the manufacturer's recommended wide-open throttle (WOT) RPM under normal loads and conditions.

Ventilation

Ventilation is when air is drawn in around the propeller blades. Normally, this causes a gain in rpm, but a loss of speed, since the propeller blades are not biting clean water. This most usually occurs during hard cornering or in certain water conditions, such as following seas.

Controlled ventilation can be beneficial, though, in helping the engine gain rpm during hard acceleration. This is engineered into certain propellers, and is most-usually used on two stroke outboards. An example of this is the small holes in the side of the propeller barrel which allow exhaust to intentionally be drawn in around the blades at hole shot. This helps two stroke engines generate the higher rpm they need for proper hole shot performance. Four stroke engines typically don't need them.

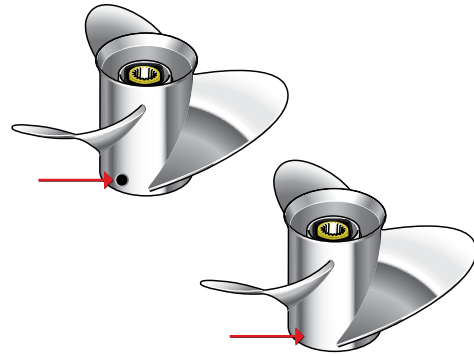

Cavitation

Cavitation occurs when pressure on the water across the blade's surface is reduced to the point of becoming water vapor, forming bubbles. If these bubbles burst, they can cause a cavitation burn which can deteriorate the propeller's surface and cause negative performance issues. As this condition can cause an increase in engine rpm, it's often confused with ventilation.

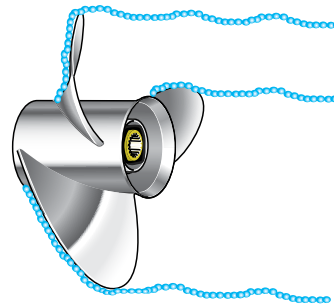

Slip

Slip is the amount of wasted energy a particular prop generates, meaning that the actual distance traveled in one full propeller revolution is less than its pitch measurement. It is normally expressed as a percentage of inefficiency. A certain amount of slip is engineered into each line of propellers to create different performance characteristics.

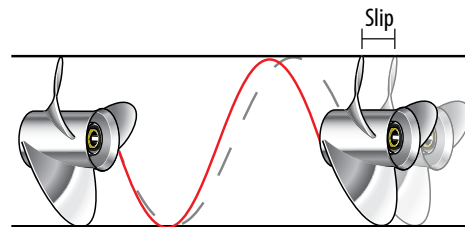

Hole Shot

"Hole shot" refers to rapid acceleration of the boat, from a standing rest or very slow speed until just on-plane. This is when the engine and the propeller work their hardest.

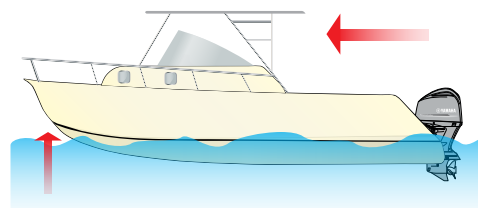

Propellers for Two Stroke 2-15, and Four Stroke F2.5-F20

Diameter	Pitch	Rotation	Material	Hub	Part Number	
2HP						
7 1/4	4	RH	PS	Shear Pin	6A1-45943-00-00	Plastic
7 1/4	4 1/2	RH	AL	Shear Pin	646-45944-01-00	Aluminum
7 1/4	5 1/2	RH	AL	Shear Pin	646-45942-01-00	Aluminum
3 F2.5HP						
7 1/4	5	RH	AL	pressed in	6L5-45949-00-00	Aluminum
7 1/2	5 1/2	RH	AL	pressed in	6L5-45952-00-00	Aluminum
7 1/4	6	RH	AL	pressed in	6L5-45943-00-00	Aluminum
7 1/4	7 1/4	RH	AL	pressed in	6L5-45945-00-00	Aluminum
7 1/4	8 1/4	RH	AL	pressed in	6L5-45947-00-00	Aluminum
4 5 F4 F4A F6A SINGLE CYL.						
7 1/4	6 1/2	RH	AL	pressed in	6E0-45949-00-00	Aluminum
7 1/2	7	RH	AL	pressed in	6E0-45943-01-00	Aluminum
7 1/2	7	RH	AL	Shear Pin	6E0-45943-09-00	Aluminum
7 1/4	7 1/4	RH	AL	pressed in	6E0-45945-00-00	Aluminum
7 1/2	8	RH	AL	pressed in	6E0-45941-01-00	Aluminum
7 1/4	8	RH	AL	Shear Pin	6E0-45941-09-00	Aluminum
7 1/4	8 1/4	RH	AL	pressed in	6E0-45952-00-00	Aluminum
7 1/2	9	RH	AL	pressed in	6E0-45954-00-00	Aluminum
6 8 F6 F8 F9.9						
8 1/2	6 1/2	RH	AL	pressed in	6G1-45947-00-00	Aluminum
8 1/2	7 1/2	RH	AL	pressed in	6G1-45943-00-00	Aluminum
8 1/2	8	RH	AL	pressed in	6G1-45952-00-00	Aluminum
8 1/2	8 1/2	RH	AL	pressed in	6G1-45941-00-00	Aluminum
8 1/2	9 1/4	RH	AL	pressed in	6G1-45954-00-00	Aluminum
T8 T9.9						
11 3/4	9 1/4	RH	PS	pressed in	6G8-45943-00-00	Plastic
11 3/4	11	RH	PS	pressed in	6G8-45941-00-00	Plastic
11 3/4	12 1/4	RH	PS	pressed in	6G8-45945-00-00	Plastic
11 3/4	5 3/4	RH	AL	pressed in	69G-45941-00-00	Aluminum
11 3/4	7	RH	AL	pressed in	69G-45943-00-00	Aluminum
11 3/4	9 1/4	RH	AL	pressed in	6G8-45947-00-00	Aluminum
9.9 15 F15C F20						
9 1/2	6 1/2	RH	AL	pressed in	683-45949-00-00	Aluminum
9 3/4	6 1/2	RH	AL	pressed in	683-W4592-02-00	Aluminum
9 1/4	8	RH	AL	pressed in	683-45947-00-00	Aluminum
9 3/4	8	RH	AL	pressed in	683-W4591-02-00	Aluminum
9 1/4	9	RH	AL	pressed in	683-45945-00-00	Aluminum
9 1/4	9 3/4	RH	AL	pressed in	683-45952-00-00	Aluminum
9 1/4	10 1/2	RH	AL	pressed in	683-45943-00-00	Aluminum
9 1/4	12	RH	AL	pressed in	683-45941-00-00	Aluminum
9 1/4	9	RH	AL	pressed in	63V-45945-10-00	Aluminum Cupped
9 1/4	8	RH	AL	pressed in	63V-45947-00-00	Aluminum Cupped
9 1/4	10	RH	AL	pressed in	63V-45952-10-00	Aluminum Cupped
9 1/4	11	RH	AL	pressed in	63V-45943-10-00	Aluminum Cupped
9 1/4	12	RH	AL	pressed in	63V-45941-10-00	Aluminum Cupped

General Information

Rigging Estimate Guide (Diagrams)

Rigging Components

Electrical Components

Engine Accessories

Propellers

Maintenance Items

Oils & Lubes

Detailing & Trailer Supplies

Accessories & Apparel

Generators & Accessories

Propellers

F Series Propellers for 3.0" Gearcases

Yamaha Models 20, 25, C25, F25, and 30

Diameter	Pitch	Blades	Rotation	Material	Hub	Part Number
DUAL THRUST™						
10 5/8	8 1/4	3	RH	AL	pressed in	6J8-W4591-00-00
ALUMINUM						
9 7/8	8	3	RH	AL	pressed in	664-45943-01-00
9 7/8	9	3	RH	AL	pressed in	664-45941-01-00
9 7/8	10 1/2	3	RH	AL	pressed in	664-45945-00-00
9 7/8	11 1/4	3	RH	AL	pressed in	664-45947-01-00
9 7/8	12	3	RH	AL	pressed in	664-45954-01-00
9 7/8	13	3	RH	AL	pressed in	664-45949-02-00
9 7/8	14	3	RH	AL	pressed in	664-45952-00-00
WEEDLESS, PAINTED STAINLESS STEEL						
9 1/8	12	3	RH	SS	pressed in	664-45972-00-00
9 1/8	13	3	RH	SS	pressed in	664-45970-00-00
PERFORMANCE 3						
10 1/8	10	3	RH	SS	pressed in	MAR-GYT3B-02-10
10 1/8	11	3	RH	SS	pressed in	MAR-GYT3B-02-11
10 1/8	12	3	RH	SS	pressed in	MAR-GYT3B-02-12
10 1/8	13	3	RH	SS	pressed in	MAR-GYT3B-02-13
10 1/8	14	3	RH	SS	pressed in	MAR-GYT3B-02-14

G Series Propellers for 3.5" Gearcases

Yamaha Models T25, F30, 40, C40, F40, E48, 50, C50, F50, 55, F60

Diameter	Pitch	Blades	Rotation	Material	Hub	Part Number
DUAL THRUST™						
12 1/4	9	3	RH	AL	pressed in	68U-45941-00-00
ALUMINUM						
12 1/4	8	3	RH	AL	pressed in	63D-45941-00-00
12 1/4	9	3	RH	AL	pressed in	663-45956-01-00
11 3/8	12	3	RH	AL	pressed in	69W-45952-00-00**
11 5/8	11	3	RH	AL	pressed in	69W-45947-00-00**
10 5/8	12	3	RH	AL	pressed in	6H5-45952-00-00**
10 3/8	13	3	RH	AL	pressed in	6H5-45945-00-00**
11 1/8	13	3	RH	AL	pressed in	69W-45945-00-00**
10 1/4	14	3	RH	AL	pressed in	6H5-45958-00-00**
11 1/4	14	3	RH	AL	pressed in	663-45958-01-00
11 1/4	14	3	RH	AL	pressed in	69W-45958-00-00**
10	15	3	RH	AL	pressed in	6H5-45943-00-00**
11	15	3	RH	AL	pressed in	69W-45943-00-00**
10 3/4	16	3	RH	AL	pressed in	663-45949-01-00
10 3/4	17	3	RH	AL	pressed in	663-45941-01-00

**Propeller part numbers beginning with "6H5-" denote propellers with cupped blades.
Propeller part numbers beginning with "69W-" denote heavier-duty propellers.

G Series Propellers for 3.5" Gearcases Continued...

Yamaha Models T25, F30, 40, C40, F40, E48, 50, C50, F50, 55, F60

Diameter	Pitch	Blades	Rotation	Material	Hub	Part Number
PAINTED STAINLESS STEEL						
12	11	3	RH	SS	pressed in	663-45972-60-00
11 3/4	12	3	RH	SS	pressed in	663-45970-60-00
11 1/2	13	3	RH	SS	pressed in	663-45974-60-00
10 1/4	14	3	RH	SS	pressed in	663-45930-00-00
11 1/4	14	3	RH	SS	pressed in	697-45970-00-00
10 1/4	15	3	RH	SS	pressed in	663-45976-00-00
10 1/4	16	3	RH	SS	pressed in	663-45978-00-00
PERFORMANCE 3						
10 1/2	10	3	RH	SS	pressed in	MAR-GYT3B-03-10
10 1/2	11	3	RH	SS	pressed in	MAR-GYT3B-03-11
10 1/2	12	3	RH	SS	pressed in	MAR-GYT3B-03-12
10 1/2	13	3	RH	SS	pressed in	MAR-GYT3B-03-13
10 1/2	14	3	RH	SS	pressed in	MAR-GYT3B-03-14
10 1/2	15	3	RH	SS	pressed in	MAR-GYT3B-03-15

K Series Propellers for 4.25" Gearcases

Yamaha Models T50, C60, E60, P60, T60, 70, F70, P75, C75, E75, F75, F80, 90, C90, F90, F100, 115, C115, F115, P115, 130

Diameter	Pitch	Blades	Rotation	Material	Hub	Part Number
DUAL THRUST™						
14	11	3	RH	AL	pressed in	68S-45941-00-00
ALUMINUM						
14	11	3	RH	AL	pressed in	6E5-45954-00-00
13 5/8	13	3	RH	AL	pressed in	6E5-45949-00-00
13 5/8	14	3	RH	AL	pressed in	6E5-45958-00-00
13 1/2	15	3	RH	AL	pressed in	6E5-45947-00-00
13 1/4	17	3	RH	AL	pressed in	6E5-45945-01-00
13	19	3	RH	AL	pressed in	6E5-45941-00-00
12 5/8	21	3	RH	AL	pressed in	6E5-45943-00-00
13	23	3	RH	AL	pressed in	6E5-45952-00-00
13	25	3	RH	AL	pressed in	6E5-45956-00-00

Propellers

K Series Propellers for 4.25" Gearcases

Yamaha Models T50, C60, E60, P60, T60, 70, F70, P75, C75, E75, F75, F80, 90, C90, F90, F100, 115, C115, F115, P115, 130

Diameter	Pitch	Blades	Rotation	Material	Hub	Part Number
TALON®						
13 1/2	9	3	RH	AL	SDS™	6EK-45941-00-00
13 1/2	10.5	3	RH	AL	SDS™	6EK-45943-00-00
13 1/2	12	3	RH	AL	SDS™	6EK-45945-00-00
13 1/2	14	3	RH	AL	SDS™	6EK-45947-00-00
13 1/2	16	3	RH	AL	SDS™	6EK-45949-00-00
TALON® GP						
13 5/8	14	3	RH	AL	SDS™	6FP-45941-00-00
13 1/2	15	3	RH	AL	SDS™	6FP-45943-00-00
13 1/4	17	3	RH	AL	SDS™	6FP-45945-00-00
13	19	3	RH	AL	SDS™	6FP-45947-00-00
12 5/8	21	3	RH	AL	SDS™	6FP-45949-00-00
TALON® SS						
13 1/8	14	3	RH	SS	SDS™	6N7-45970-00-00
13 1/8	14	3	LH	SS	SDS™	6N4-45970-00-00
13 1/8	16	3	RH	SS	SDS™	6N7-45972-00-00
13 1/8	16	3	LH	SS	SDS™	6N4-45972-00-00
13 1/8	18	3	RH	SS	SDS™	6N7-45974-00-00
13 1/8	18	3	LH	SS	SDS™	6N4-45974-00-00
13 1/8	19	3	RH	SS	SDS™	6N7-45976-00-00
13 1/8	20	3	RH	SS	SDS™	6N7-45978-00-00
13 1/8	20	3	LH	SS	SDS™	6N4-45978-00-00
13 1/8	22	3	RH	SS	SDS™	6N7-45930-00-00
13 1/8	24	3	RH	SS	SDS™	6N7-45932-00-00
TALON® PONTOON						
14	9	3	RH	SS	pressed in	6H1-45970-00-00
14	10	3	RH	SS	SDS™	6H1-45972-00-00
14	11	3	RH	SS	SDS™	6H1-45974-00-00
14	12	3	RH	SS	SDS™	6H1-45976-00-00
14	13	3	RH	SS	SDS™	6H1-45978-00-00
Talon SS4						
13 1/4	14	4	RH	SS	SDS™	6N6-45B70-00-00
13 1/4	16	4	RH	SS	pressed in	6N6-45B72-00-00
13 1/4	18	4	RH	SS	pressed in	6N6-45B74-00-00
13 1/4	20	4	RH	SS	pressed in	6N6-45B76-00-00
13 1/4	22	4	RH	SS	pressed in	6N6-45B78-00-00
13 1/4	23	4	RH	SS	pressed in	6N6-45B80-00-00

K Series Propellers for 4.25" Gearcases Continued...

Yamaha Models T50, C60, E60, P60, T60, 70, F70, P75, C75, E75, F75, F80, 90, C90, F90, F100, 115, C115, F115, P115, 130

Diameter	Pitch	Blades	Rotation	Material	Hub	Part Number
PAINTED STAINLESS STEEL						
13 1/2	14	3	RH	SS	pressed in	688-45932-60-00
13 1/2	16	3	RH	SS	pressed in	688-45978-60-00
13	17	3	RH	SS	pressed in	688-45930-02-00
13	17	3	LH	SS	pressed in	6L6-45930-01-00
13	19	3	RH	SS	pressed in	688-45970-03-00
13	19	3	LH	SS	pressed in	6L6-45970-00-00
13	21	3	RH	SS	pressed in	688-45972-02-00
13	21	3	LH	SS	pressed in	6L6-45972-00-00
13	23	3	RH	SS	pressed in	688-45974-02-00
13	25	3	RH	SS	pressed in	688-45976-01-00
PERFORMANCE 3						
13 1/4	14	3	RH	SS	pressed in	MAR-GYT3B-V4-14
13 1/4	14	3	LH	SS	pressed in	MAR-GYT3B-L4-14
13 1/4	16	3	RH	SS	pressed in	MAR-GYT3B-V4-16
13 1/4	16	3	LH	SS	pressed in	MAR-GYT3B-L4-16
13 1/4	18	3	RH	SS	pressed in	MAR-GYT3B-V4-18
13 1/4	18	3	LH	SS	pressed in	MAR-GYT3B-L4-18
13 1/4	20	3	RH	SS	pressed in	MAR-GYT3B-V4-20
13 1/4	20	3	LH	SS	pressed in	MAR-GYT3B-L4-20
13 1/4	22	3	RH	SS	pressed in	MAR-GYT3B-V4-22
13 1/4	22	3	LH	SS	pressed in	MAR-GYT3B-L4-22
13 1/4	24	3	RH	SS	pressed in	MAR-GYT3B-V4-24

M or T Series Propellers for 4.75" Gearcases

Yamaha Models 150-300, F150-F300 (V6)

Diameter	Pitch	Blades	Rotation	Material	Hub	Part Number
ALUMINUM						
15 1/4	15	3	RH	AL	pressed in	6G5-45941-00-00*
14 5/8	16	3	RH	AL	pressed in	6G5-45952-00-00*
14 1/2	17	3	RH	AL	pressed in	6G5-45947-01-00*
14 1/2	17	3	LH	AL	pressed in	6K1-45947-00-00*
14	19	3	RH	AL	pressed in	6G5-45945-01-00*
14	19	3	LH	AL	pressed in	6K1-45945-00-00*
13 3/4	21	3	RH	AL	pressed in	6G5-45943-01-00*
13 1/2	23	3	RH	AL	pressed in	6G5-45949-00-00*

*Not recommended for outboards over 225hp.

Propellers

M or T Series Propellers for 4.75" Gearcases Continued...

Yamaha Models 150-300, F150-F300 (V6)

Diameter	Pitch	Blades	Rotation	Material	Hub	Part Number
PAINTED STAINLESS STEEL						
13 3/4	17	3	RH	SS	pressed in	6G5-45978-03-00
13 3/4	17	3	LH	SS	pressed in	6K1-45978-02-00
13 3/4	19	3	RH	SS	pressed in	6G5-45974-03-00
13 3/4	19	3	LH	SS	pressed in	6K1-45974-02-00
13 3/4	21	3	RH	SS	pressed in	6G5-45972-02-00
13 3/4	21	3	LH	SS	pressed in	6K1-45972-01-00
13 3/8	23	3	RH	SS	pressed in	6G5-45976-01-00
13 3/8	23	3	LH	SS	pressed in	6K1-45976-00-00
14 1/2	19	3	RH	SS	pressed in	61A-45974-00-00**
14 1/2	19	3	LH	SS	pressed in	61B-45974-00-00**
14 1/2	21	3	RH	SS	pressed in	61A-45972-00-00**
14 1/2	21	3	LH	SS	pressed in	61B-45972-00-00**
15 3/4	13	3	RH	SS	pressed in	6G5-45932-00-00
15 1/4	15	3	RH	SS	pressed in	6G5-45970-02-00
15 1/4	15	3	LH	SS	pressed in	6K1-45970-01-00
15	17	3	RH	SS	pressed in	61A-45978-00-00**
15	17	3	LH	SS	pressed in	61B-45978-00-00**
PRO SERIES™						
14 1/2	21	3	RH	SS	pressed in	66K-45976-B0-00*
14 1/2	23	3	RH	SS	pressed in	66K-45974-B0-00*
14 1/2	25	3	RH	SS	pressed in	66K-45972-B0-00*
14 1/2	27	3	RH	SS	pressed in	66K-45970-B0-00*
V MAX SHO®						
15 1/8	22	3	RH	SS	pressed in	6CB-45932-11-00
15 1/8	23	3	RH	SS	pressed in	6CB-45974-11-00
15 1/8	24	3	RH	SS	pressed in	6CB-45930-11-00
15 1/8	25	3	RH	SS	pressed in	6CB-45972-11-00
15 1/8	26	3	RH	SS	pressed in	6CB-45978-11-00
15 1/8	27	3	RH	SS	pressed in	6CB-45970-11-00
PERFORMANCE XT						
14 5/8	17	3	RH	SS	pressed in	MAR-GYT3B-XL-17**
14 5/8	19	3	RH	SS	pressed in	MAR-GYT3B-XL-19**
14 5/8	21	3	RH	SS	pressed in	MAR-GYT3B-XL-21**
14 5/8	22	3	RH	SS	pressed in	MAR-GYT3B-XL-22**
14 5/8	23	3	RH	SS	pressed in	MAR-GYT3B-XL-23**
14 5/8	25	3	RH	SS	pressed in	MAR-GYT3B-XL-25**
14 5/8	27	3	RH	SS	pressed in	MAR-GYT3B-XL-27**

*Not recommended for outboards over 225hp.

**Recommended for 3.3L outboards, 250-300hp.

M or T Series Propellers for 4.75" Gearcases Continued...

Yamaha Models 150-300, F150-F300 (V6)

Diameter	Pitch	Blades	Rotation	Material	Hub	Part Number
PERFORMANCE 4						
13 3/4	18	4	LH	SS	pressed in	MAR-GYT4B-V6-18*
13 3/4	20	4	RH	SS	pressed in	MAR-GYT4B-V6-20*
13 3/4	22	4	LH	SS	pressed in	MAR-GYT4B-V6-22*
13 3/4	23	4	RH	SS	pressed in	MAR-GYT4B-V6-23*
13 3/4	24	4	LH	SS	pressed in	MAR-GYT4B-V6-24*
13 3/4	25	4	RH	SS	pressed in	MAR-GYT4B-V6-25*
13 3/4	26	4	LH	SS	pressed in	MAR-GYT4B-V6-26*
PERFORMANCE 3						
14 1/4	14	3	RH	SS	SDS™	60H-45970-00-00
14 1/4	14	3	LH	SS	SDS™	60J-45970-00-00
14 1/4	16	3	RH	SS	SDS™	60H-45972-00-00
14 1/4	16	3	LH	SS	SDS™	60J-45972-00-00
14 1/4	18	3	RH	SS	SDS™	60H-45974-00-00
14 1/4	18	3	LH	SS	SDS™	60J-45974-00-00
14 1/4	20	3	RH	SS	SDS™	60H-45976-00-00
14 1/4	20	3	LH	SS	SDS™	60J-45976-00-00
14 1/4	22	3	RH	SS	SDS™	60H-45978-00-00
14 1/4	22	3	LH	SS	SDS™	60J-45978-00-00
RELIANCE®						
14 1/2	13	3	RH	SS	SDS*	68F-45932-20-00
14 1/2	14	3	RH	SS	SDS*	68F-45930-20-00
14 1/2	14	3	LH	SS	SDS*	68G-45930-20-00
14 1/2	15	3	RH	SS	SDS*	68F-45970-20-00
14 1/2	15	3	LH	SS	SDS*	68G-45970-20-00
14 1/4	17	3	RH	SS	SDS*	68F-45972-20-00
14 1/4	17	3	LH	SS	SDS*	68G-45972-20-00
14 1/4	18	3	RH	SS	SDS*	68F-45978-20-00
14 1/4	18	3	LH	SS	SDS*	68G-45978-20-00
13 3/4	19	3	RH	SS	SDS*	68F-45974-20-00
13 3/4	19	3	LH	SS	SDS*	68G-45974-20-00
13 3/4	21	3	RH	SS	SDS*	68F-45976-20-00
13 3/4	21	3	LH	SS	SDS*	68G-45976-20-00

*Not recommended for outboards over 225hp.

**Recommended for 3.3L outboards, 250-300hp.

Propellers

M or T Series Propellers for 4.75" Gearcases Continued...

Yamaha Models 150-300, F150-F300 (V6)

Diameter	Pitch	Blades	Rotation	Material	Hub	Part Number
SALTWATER SERIES II						
15 3/4	13	3	RH	SS	SDS™	6CE-45930-20-00
15 3/4	13	3	LH	SS	SDS™	6CF-45930-20-00
15 3/4	15	3	RH	SS	SDS™	6CE-45976-20-00
15 3/4	15	3	LH	SS	SDS™	6CF-45976-20-00
15 1/2	16	3	RH	SS	SDS™	6CE-45938-20-00
15 1/2	17	3	RH	SS	SDS™	6CE-45978-20-00
15 1/2	17	3	LH	SS	SDS™	6CF-45978-20-00
15 1/4	18	3	RH	SS	SDS™	6CE-45934-20-00
15 1/4	18	3	LH	SS	SDS™	6CF-45934-20-00
15 1/4	19	3	RH	SS	SDS™	6CE-45970-20-00
15 1/4	19	3	LH	SS	SDS™	6CF-45970-20-00
15	20	3	RH	SS	SDS™	6CE-45932-20-00
15	20	3	LH	SS	SDS™	6CF-45932-20-00
15	21	3	RH	SS	SDS™	6CE-45972-20-00
15	21	3	LH	SS	SDS™	6CF-45972-20-00
14 3/4	22	3	RH	SS	SDS™	6CE-45936-20-00
14 3/4	22	3	LH	SS	SDS™	6CF-45936-20-00
14 3/4	23	3	RH	SS	SDS™	6CE-45974-20-00
14 3/4	23	3	LH	SS	SDS™	6CF-45974-20-00
HS4 "HIGH SEAS" SERIES						
15	21	4	RH	SS	SDS™	6CE-45B70-20-00**
15	21	4	LH	SS	SDS™	6CF-45B70-20-00**
15	22	4	RH	SS	SDS™	6CE-45B72-20-00**
15	22	4	LH	SS	SDS™	6CF-45B72-20-00**
15	23	4	RH	SS	SDS™	6CE-45B74-20-00**
15	23	4	LH	SS	SDS™	6CF-45B74-20-00**

TRP Propellers for TRP Gearcases

Diameter	Pitch	Series	Fit	Blades	Part Number
14	19	TRP Lower Units	Front	3	MAR-TRP14-19-F3
13	19	TRP Lower Units	Rear	3	MAR-TRP13-19-R3
14	21	TRP Lower Units	Front	3	MAR-TRP14-21-F3
13	21	TRP Lower Units	Rear	3	MAR-TRP13-21-R3



X Series Propellers for 5.25" Gearcases

Yamaha V8 Outboard Models

Diameter	Pitch	RH / LH	Series	Hub	Blades	Part Number
Saltwater Series XL4™-HP						
15 3/8	22	RH	Saltwater Series XL4™-HP -SDS	SDS™	4	6AW-45B76-20-00
15 3/8	22	LH	Saltwater Series XL4-HP -SDS	SDS™	4	6AX-45B76-20-00
15 3/8	24	RH	Saltwater Series XL4™-HP -SDS	SDS™	4	6AW-45B74-20-00
15 3/8	24	LH	Saltwater Series XL4-HP -SDS	SDS™	4	6AX-45B74-20-00
Saltwater Series XL4™						
16 1/8	15	RH	Saltwater Series XL4™ -SDS	SDS™	4	6AW-45B70-20-00
16 1/8	15	LH	Saltwater Series XL4 -SDS	SDS™	4	6AX-45B70-20-00
16 1/8	17	RH	Saltwater Series XL4 -SDS	SDS™	4	6AW-45B72-20-00
16 1/8	17	LH	Saltwater Series XL4 -SDS	SDS™	4	6AX-45B72-20-00
Saltwater Series XL						
16 1/4	15	RH	Saltwater Series XL - SDS	SDS™	3	6AW-45970-20-00
16 1/4	15	LH	Saltwater Series XL - SDS	SDS™	3	6AX-45970-20-00
16 1/4	17	RH	Saltwater Series XL - SDS	SDS™	3	6AW-45972-20-00
16 1/4	17	LH	Saltwater Series XL - SDS	SDS™	3	6AX-45972-20-00
15 1/2	19	RH	Saltwater Series XL - SDS	SDS™	3	6AW-45974-20-00
15 1/2	19	LH	Saltwater Series XL - SDS	SDS™	3	6AX-45974-20-00
15 1/4	21	RH	Saltwater Series XL - SDS	SDS™	3	6AW-45976-20-00
15 1/4	21	LH	Saltwater Series XL - SDS	SDS™	3	6AX-45976-20-00
15 1/4	23	RH	Saltwater Series XL - SDS	SDS™	3	6AW-45978-20-00
15 1/4	23	LH	Saltwater Series XL - SDS	SDS™	3	6AX-45978-20-00

Propellers

Y Series Propellers for 5.25" Gearcases

Yamaha 5.6L XTO Offshore® V8 Outboard Models

Diameter	Pitch	Blades	Rotation	Material	Hub	Part Number
SALTWATER SERIES II						
17 1/8	15	3	RH	SS	SDS*	6GR-45970-00-00
17 1/8	15	3	LH	SS	SDS*	6GS-45970-00-00
16 7/8	17	3	RH	SS	SDS*	6GR-45972-00-00
16 7/8	17	3	LH	SS	SDS*	6GS-45972-00-00
16 5/8	19	3	RH	SS	SDS*	6GR-45974-00-00
16 5/8	19	3	LH	SS	SDS*	6GS-45974-00-00
16 3/8	21	3	RH	SS	SDS*	6GR-45976-00-00
16 3/8	21	3	LH	SS	SDS*	6GS-45976-00-00
16 1/8	23	3	RH	SS	SDS*	6GR-45978-00-00
16 1/8	23	3	LH	SS	SDS*	6GS-45978-00-00
16	25	3	RH	SS	SDS*	6GR-45930-00-00
16	25	3	LH	SS	SDS*	6GS-45930-00-00

Propellers

General Information

Rigging Estimate Guide (Diagrams)

Rigging Components

Electrical Components

Engine Accessories

Maintenance Items

Oils & Lubes

Detailing & Trailer Supplies

Accessories & Apparel

Generators & Accessories

Small Hub Propellers for High Performance Applications

Diameter	Pitch	Series	Fit	Blades	Part Number
14	20	Small Hub	None	3	6E5-45970-10-00
14	22	Small Hub	None	3	6E5-45976-10-00
14	24	Small Hub	None	3	6E5-45972-10-00
14	26	Small Hub	None	3	6E5-45978-10-00
14	28	Small Hub	None	3	6E5-45974-10-00



TRP Propellers for TRP Gearcases

Diameter	Pitch	Series	Fit	Blades	Part Number
14	19	TRP Lower Units	Front	3	MAR-TRP14-19-F3
13	19	TRP Lower Units	Rear	3	MAR-TRP13-19-R3
14	21	TRP Lower Units	Front	3	MAR-TRP14-21-F3
13	21	TRP Lower Units	Rear	3	MAR-TRP13-21-R3



Propellers



Propellers for 3.0" (F Series) Gearcases

Diameter	Pitch	Blades	Rotation	Material	Hub	Part Number
HOT SHOT FOR JOHNSON®, EVINRUDE®						
10 1/8	10	3	RH	SS	pressed-in	MAR-10110-OR-B0
10 1/8	11	3	RH	SS	pressed-in	MAR-10111-OR-B0
10 1/8	12	3	RH	SS	pressed-in	MAR-10112-OR-B0
10 1/8	13	3	RH	SS	pressed-in	MAR-10113-OR-B0
10 1/8	14	3	RH	SS	pressed-in	MAR-10114-OR-B0
10 1/8	15	3	RH	SS	pressed-in	MAR-10115-OR-B0
HOT SHOT FOR MERCURY®						
10 1/8	10	3	RH	SS	pressed-in	MAR-10110-MR-B0
10 1/8	11	3	RH	SS	pressed-in	MAR-10111-MR-B0
10 1/8	12	3	RH	SS	pressed-in	MAR-10112-MR-B0
10 1/8	13	3	RH	SS	pressed-in	MAR-10113-MR-B0
10 1/8	14	3	RH	SS	pressed-in	MAR-10114-MR-B0
10 1/8	15	3	RH	SS	pressed-in	MAR-10115-MR-B0
HOT SHOT FOR NISSAN®/TOHATSU®						
10 1/8	10	3	RH	SS	pressed-in	MAR-10110-NR-B0
10 1/8	11	3	RH	SS	pressed-in	MAR-10111-NR-B0
10 1/8	12	3	RH	SS	pressed-in	MAR-10112-NR-B0
10 1/8	13	3	RH	SS	pressed-in	MAR-10113-NR-B0
10 1/8	14	3	RH	SS	pressed-in	MAR-10114-NR-B0
10 1/8	15	3	RH	SS	pressed-in	MAR-10115-NR-B0
HOT SHOT FOR SUZUKI®						
10 1/8	10	3	RH	SS	pressed-in	MAR-10110-SR-B0
10 1/8	11	3	RH	SS	pressed-in	MAR-10111-SR-B0
10 1/8	12	3	RH	SS	pressed-in	MAR-10112-SR-B0
10 1/8	13	3	RH	SS	pressed-in	MAR-10113-SR-B0
10 1/8	14	3	RH	SS	pressed-in	MAR-10114-SR-B0
10 1/8	15	3	RH	SS	pressed-in	MAR-10115-SR-B0



Propellers for 3.5" (G Series) Gearcases

Diameter	Pitch	Blades	Rotation	Material	Hub	Part Number
HOT SHOT						
10 1/2	10	3	RH	SS	See Hub Charts*	MAR-10510-HR-C0
10 1/2	11	3	RH	SS	See Hub Charts*	MAR-10511-HR-C0
10 1/2	12	3	RH	SS	See Hub Charts*	MAR-10512-HR-C0
10 1/2	13	3	RH	SS	See Hub Charts*	MAR-10513-HR-C0
10 1/2	14	3	RH	SS	See Hub Charts*	MAR-10514-HR-C0
10 1/2	15	3	RH	SS	See Hub Charts*	MAR-10515-HR-C0
10 1/2	16	3	RH	SS	See Hub Charts*	MAR-10516-HR-C0
10 1/2	17	3	RH	SS	See Hub Charts*	MAR-10517-HR-C0

*Most Turbo propellers "G" series (3.5" gearcase diameter) and up require a Guardian SQ-LOK™ hub kit or similar universal hub system. (sold separately) Please see the "Turbo Hub Application Charts" beginning on page 5-37 to determine your required hub.



Propellers for 3.5" (G Series) Gearcases Continued...

Diameter	Pitch	Blades	Rotation	Material	Hub	Part Number
HOT SHOT FOR JOHNSON®, EVINRUDE®						
11 3/4	13	3	RH	SS	See Hub Charts*	MAR-11713-HR-C0
11 3/4	15	3	RH	SS	See Hub Charts*	MAR-11715-HR-C0
11 3/4	17	3	RH	SS	See Hub Charts*	MAR-11717-HR-C0
11 3/4	19	3	RH	SS	See Hub Charts*	MAR-11719-HR-C0
PONTOON 1						
12	9	3	RH	SS	See Hub Charts*	MAR-12009-PR-C0
12	11	3	RH	SS	See Hub Charts*	MAR-12011-PR-C0
12	12	3	RH	SS	See Hub Charts*	MAR-12012-PR-C0
12	13	3	RH	SS	See Hub Charts*	MAR-12013-PR-C0
12	15	3	RH	SS	See Hub Charts*	MAR-12015-PR-C0
PONTOON 1 FOR JOHNSON®, EVINRUDE®						
12	9	3	RH	SS	See Hub Charts*	MAR-12109-PR-C0
12	11	3	RH	SS	See Hub Charts*	MAR-12111-PR-C0
12	12	3	RH	SS	See Hub Charts*	MAR-12112-PR-C0
12	13	3	RH	SS	See Hub Charts*	MAR-12113-PR-C0
12	15	3	RH	SS	See Hub Charts*	MAR-12115-PR-C0



Propellers for 4.25" (K Series) Gearcases

Diameter	Pitch	Blades	Rotation	Material	Hub	Part Number
TURBO 1						
13 1/4	13	3	RH	SS	See Hub Charts*	MAR-13213-TR-D0
13 1/4	15	3	RH	SS	See Hub Charts*	MAR-13215-TR-D0
13 1/4	17	3	RH	SS	See Hub Charts*	MAR-13217-TR-D0
13 1/4	19	3	RH	SS	See Hub Charts*	MAR-13219-TR-D0
13 1/4	21	3	RH	SS	See Hub Charts*	MAR-13221-TR-D0
13 1/4	23	3	RH	SS	See Hub Charts*	MAR-13223-TR-D0
13 1/4	25	3	RH	SS	See Hub Charts*	MAR-13225-TR-D0
TURBO 1 FOR SUZUKI®						
14	16	3	RH	SS	See Hub Charts*	MAR-14016-SR-E0
14	18	3	RH	SS	See Hub Charts*	MAR-14018-SR-E0
14	20	3	RH	SS	See Hub Charts*	MAR-14020-SR-E0
14	22	3	RH	SS	See Hub Charts*	MAR-14022-SR-E0
PONTOON 1						
14	9	3	RH	SS	See Hub Charts*	MAR-14009-PR-D0
14	11	3	RH	SS	See Hub Charts*	MAR-14011-PR-D0
14	13	3	RH	SS	See Hub Charts*	MAR-14013-PR-D0
14	15	3	RH	SS	See Hub Charts*	MAR-14015-PR-D0

*Most Turbo propellers "G" series (3.5" gearcase diameter) and up require a Guardian SQ-LOK™ hub kit or similar universal hub system. (sold separately) Please see the "Turbo Hub Application Charts" beginning on page 5-37 to determine your required hub.

Propellers



Propellers for 4.25" (K Series) Gearcases Continued...

Diameter	Pitch	Blades	Rotation	Material	Hub	Part Number
PONTOON 1 FOR JOHNSON®, EVINRUDE®						
14	9	3	RH	SS	See Hub Charts*	MAR-14109-PR-D0
14	11	3	RH	SS	See Hub Charts*	MAR-14111-PR-D0
14	13	3	RH	SS	See Hub Charts*	MAR-14113-PR-D0
14	15	3	RH	SS	See Hub Charts*	MAR-14115-PR-D0
FX4						
13 1/4	14	4	RH	SS	See Hub Charts*	MAR-13414-XR-D0
13 1/4	16	4	RH	SS	See Hub Charts*	MAR-13416-XR-D0
13 1/4	18	4	RH	SS	See Hub Charts*	MAR-13418-XR-D0
13 1/4	20	4	RH	SS	See Hub Charts*	MAR-13420-XR-D0
13 1/4	22	4	RH	SS	See Hub Charts*	MAR-13422-XR-D0
13 1/4	23	4	RH	SS	See Hub Charts*	MAR-13423-XR-D0
13 1/4	24	4	RH	SS	See Hub Charts*	MAR-13424-XR-D0
13 1/4	25	4	RH	SS	See Hub Charts*	MAR-13425-XR-D0
QUEST™						
13 1/8	14	4	RH	SS	See Hub Charts*	MAR-13414-QR-D0
13 1/8	15	4	RH	SS	See Hub Charts*	MAR-13415-QR-D0
13 1/8	16	4	RH	SS	See Hub Charts*	MAR-13416-QR-D0
13 1/8	17	4	RH	SS	See Hub Charts*	MAR-13417-QR-D0
13 1/8	18	4	RH	SS	See Hub Charts*	MAR-13418-QR-D0
13 1/8	19	4	RH	SS	See Hub Charts*	MAR-13419-QR-D0
13 1/8	20	4	RH	SS	See Hub Charts*	MAR-13420-QR-D0
13 1/8	21	4	RH	SS	See Hub Charts*	MAR-13421-QR-D0



Propellers for 4.75" (M/T Series) Gearcases

Diameter	Pitch	Blades	Rotation	Material	Hub	Part Number
TURBO 1						
14 1/4	13	3	RH	SS	See Hub Charts*	MAR-14213-TR-E0
14 1/4	15	3	RH	SS	See Hub Charts*	MAR-14215-TR-E0
14 1/4	15	3	LH	SS	See Hub Charts*	MAR-14215-TL-E0
14 1/4	17	3	RH	SS	See Hub Charts*	MAR-14217-TR-E0
14 1/4	17	3	LH	SS	See Hub Charts*	MAR-14217-TL-E0
14 1/4	19	3	RH	SS	See Hub Charts*	MAR-14219-TR-E0
14 1/4	19	3	LH	SS	See Hub Charts*	MAR-14219-TL-E0
14 1/4	20	3	RH	SS	See Hub Charts*	MAR-14220-TR-E0
14 1/4	21	3	RH	SS	See Hub Charts*	MAR-14221-TR-E0
14 1/4	21	3	LH	SS	See Hub Charts*	MAR-14221-TL-E0
14 1/4	22	3	RH	SS	See Hub Charts*	MAR-14222-TR-E0
14 1/4	23	3	RH	SS	See Hub Charts*	MAR-14223-TR-E0
14 1/4	24	3	RH	SS	See Hub Charts*	MAR-14224-TR-E0
14 1/4	25	3	RH	SS	See Hub Charts*	MAR-14225-TR-E0

*Most Turbo propellers "G" series (3.5" gearcase diameter) and up require a Guardian SQ-LOK™ hub kit or similar universal hub system. (sold separately) Please see the "Turbo Hub Application Charts" beginning on page 5-37 to determine your required hub.



Propellers for 4.75" (M/T Series) Gearcases Continued...

Diameter	Pitch	Blades	Rotation	Material	Hub	Part Number
FXP						
14 3/4	22	3	RH	SS	pressed-in	MAR-14722-R0-00
14 3/4	23	3	RH	SS	pressed-in	MAR-14723-R0-00
14 3/4	24	3	RH	SS	pressed-in	MAR-14724-R0-00
14 3/4	25	3	RH	SS	pressed-in	MAR-14725-R0-00
14 3/4	26	3	RH	SS	pressed-in	MAR-14726-R0-00
14 3/4	27	3	RH	SS	pressed-in	MAR-14727-R0-00
LIGHTNING						
14 1/2	17	3	RH	SS	See Hub Charts*	MAR-14517-LR-E0
14 1/2	19	3	RH	SS	See Hub Charts*	MAR-14519-LR-E0
14 1/2	21	3	RH	SS	See Hub Charts*	MAR-14521-LR-E0
14 3/4	22	3	RH	SS	See Hub Charts*	MAR-14522-LR-E0
14 3/4	23	3	RH	SS	See Hub Charts*	MAR-14523-LR-E0
14 3/4	24	3	RH	SS	See Hub Charts*	MAR-14524-LR-E0
14 3/4	25	3	RH	SS	See Hub Charts*	MAR-14525-LR-E0
14 3/4	26	3	RH	SS	See Hub Charts*	MAR-14526-LR-E0
14 3/4	27	3	RH	SS	See Hub Charts*	MAR-14527-LR-E0
OFFSHORE II						
15	16	3	RH	SS	See Hub Charts*	MAR-15016-OR-E0
15	16	3	LH	SS	See Hub Charts*	MAR-15016-OL-E0
15	18	3	RH	SS	See Hub Charts*	MAR-15018-OR-E0
15	18	3	LH	SS	See Hub Charts*	MAR-15018-OL-E0
15	20	3	RH	SS	See Hub Charts*	MAR-15020-OR-E0
15	20	3	LH	SS	See Hub Charts*	MAR-15020-OL-E0
15	22	3	RH	SS	See Hub Charts*	MAR-15022-OR-E0
15	22	3	LH	SS	See Hub Charts*	MAR-15022-OL-E0
15	24	3	RH	SS	See Hub Charts*	MAR-15024-OR-E0
15	24	3	LH	SS	See Hub Charts*	MAR-15024-OL-E0
15	26	3	RH	SS	See Hub Charts*	MAR-15026-OR-E0
15	26	3	LH	SS	See Hub Charts*	MAR-15026-OL-E0
VECTOR						
14 1/2	21	3	RH	SS	See Hub Charts*	MAR-14521-VR-E0
14 1/2	21	3	LH	SS	See Hub Charts*	MAR-14521-VL-E0
14 1/2	22	3	RH	SS	See Hub Charts*	MAR-14522-VR-E0
14 1/2	22	3	LH	SS	See Hub Charts*	MAR-14522-VL-E0
14 1/2	23	3	LH	SS	See Hub Charts*	MAR-14523-VL-E0
14 1/2	23	3	RH	SS	See Hub Charts*	MAR-14523-VR-E0
14 1/2	24	3	RH	SS	See Hub Charts*	MAR-14524-VR-E0
14 1/2	24	3	LH	SS	See Hub Charts*	MAR-14524-VL-E0
14 1/2	25	3	RH	SS	See Hub Charts*	MAR-14525-VR-E0
14 1/2	25	3	LH	SS	See Hub Charts*	MAR-14525-VL-E0

*Most Turbo propellers "G" series (3.5" gearcase diameter) and up require a Guardian SQ-LOK™ hub kit or similar universal hub system. (sold separately) Please see the "Turbo Hub Application Charts" beginning on page 5-37 to determine your required hub.



Propellers for 4.75" (M/T Series) Gearcases Continued...

Diameter	Pitch	Blades	Rotation	Material	Hub	Part Number
OFFSHORE I						
14 1/2	15	4	RH	SS	See Hub Charts*	MAR-14415-0R-E0
14 1/2	15	4	LH	SS	See Hub Charts*	MAR-14415-0L-E0
14 1/2	17	4	RH	SS	See Hub Charts*	MAR-14417-0R-E0
14 1/2	17	4	LH	SS	See Hub Charts*	MAR-14417-0L-E0
14 1/2	19	4	RH	SS	See Hub Charts*	MAR-14419-0R-E0
14 1/2	19	4	LH	SS	See Hub Charts*	MAR-14419-0L-E0
14 1/2	21	4	RH	SS	See Hub Charts*	MAR-14421-0R-E0
14 1/2	21	4	LH	SS	See Hub Charts*	MAR-14421-0L-E0
14 1/2	23	4	RH	SS	See Hub Charts*	MAR-14423-0R-E0
14 1/2	23	4	LH	SS	See Hub Charts*	MAR-14423-0L-E0
14 1/2	25	4	RH	SS	See Hub Charts*	MAR-14425-0R-E0
14 1/2	25	4	LH	SS	See Hub Charts*	MAR-14425-0L-E0
OFFSHORE I FOR SUZUKI®						
15	20	4	RH	SS	See Hub Charts*	MAR-15420-0R-E0
15	20	4	LH	SS	See Hub Charts*	MAR-15420-0L-E0
15	22	4	RH	SS	See Hub Charts*	MAR-15422-0R-E0
15	22	4	LH	SS	See Hub Charts*	MAR-15422-0L-E0
15	24	4	RH	SS	See Hub Charts*	MAR-15424-0R-E0
15	24	4	LH	SS	See Hub Charts*	MAR-15424-0L-E0
15	26	4	RH	SS	See Hub Charts*	MAR-15426-0R-E0
15	26	4	LH	SS	See Hub Charts*	MAR-15426-0L-E0
TXP™						
14 3/4	21	3	RH	SS	See Hub Charts*	MAR-14721-XR-E0
14 3/4	23	3	RH	SS	See Hub Charts*	MAR-14723-XR-E0
14 3/4	24	3	RH	SS	See Hub Charts*	MAR-14724-XR-E0
14 3/4	25	3	RH	SS	See Hub Charts*	MAR-14725-XR-E0
14 3/4	26	3	RH	SS	See Hub Charts*	MAR-14726-XR-E0
14 3/4	27	3	RH	SS	See Hub Charts*	MAR-14727-XR-E0
14 3/4	28	3	RH	SS	See Hub Charts*	MAR-14728-XR-E0
14 3/4	29	3	RH	SS	See Hub Charts*	MAR-14729-XR-E0
14 3/4	30	3	RH	SS	See Hub Charts*	MAR-14730-XR-E0
14 3/4	31	3	RH	SS	See Hub Charts*	MAR-14731-XR-E0
14 3/4	32	3	RH	SS	See Hub Charts*	MAR-14732-XR-E0
TURBO 2+2 OT						
13 3/4	18	4	RH	SS	See Hub Charts*	MAR-13418-TR-E0
13 3/4	20	4	RH	SS	See Hub Charts*	MAR-13420-TR-E0
13 3/4	22	4	RH	SS	See Hub Charts*	MAR-13422-TR-E0
13 3/4	23	4	RH	SS	See Hub Charts*	MAR-13423-TR-E0
13 3/4	24	4	RH	SS	See Hub Charts*	MAR-13424-TR-E0
13 3/4	25	4	RH	SS	See Hub Charts*	MAR-13425-TR-E0
13 3/4	26	4	RH	SS	See Hub Charts*	MAR-13426-TR-E0

*Most Turbo propellers "G" series (3.5" gearcase diameter) and up require a Guardian SQ-LOK™ hub kit or similar universal hub system. (sold separately) Please see the "Turbo Hub Application Charts" beginning on page 5-37 to determine your required hub.



Propellers for 4.75" (M/T Series) Gearcases Continued...

Diameter	Pitch	Blades	Rotation	Material	Hub	Part Number
TXP™ (ADJUSTABLE VENTILATION PORTS)						
14 3/4	23	3	RH	SS	See Hub Charts*	MAR-14723-XR-EM
14 3/4	24	3	RH	SS	See Hub Charts*	MAR-14724-XR-EM
14 3/4	25	3	RH	SS	See Hub Charts*	MAR-14725-XR-EM
14 3/4	26	3	RH	SS	See Hub Charts*	MAR-14726-XR-EM
14 3/4	27	3	RH	SS	See Hub Charts*	MAR-14727-XR-EM
14 3/4	28	3	RH	SS	See Hub Charts*	MAR-14728-XR-EM
14 3/4	29	3	RH	SS	See Hub Charts*	MAR-14729-XR-EM
14 3/4	30	3	RH	SS	See Hub Charts*	MAR-14730-XR-EM
14 3/4	31	3	RH	SS	See Hub Charts*	MAR-14731-XR-EM
14 3/4	32	3	RH	SS	See Hub Charts*	MAR-14732-XR-EM
TXP™ OT4						
14 3/8	23	4	RH	SS	See Hub Charts*	MAR-14423-TR-E0
14 3/8	24	4	RH	SS	See Hub Charts*	MAR-14424-TR-E0
14 3/8	25	4	RH	SS	See Hub Charts*	MAR-14425-TR-E0
14 3/8	26	4	RH	SS	See Hub Charts*	MAR-14426-TR-E0
14 3/8	27	4	RH	SS	See Hub Charts*	MAR-14427-TR-E0
14 3/8	28	4	RH	SS	See Hub Charts*	MAR-14428-TR-E0
14 3/8	29	4	RH	SS	See Hub Charts*	MAR-14429-TR-E0
14 3/8	30	4	RH	SS	See Hub Charts*	MAR-14430-TR-E0
14 3/8	31	4	RH	SS	See Hub Charts*	MAR-14431-TR-E0
14 3/8	32	4	RH	SS	See Hub Charts*	MAR-14432-TR-E0
TXP™ OT4 (ADJUSTABLE VENTILATION PORTS)						
14 3/8	24	4	RH	SS	See Hub Charts*	MAR-14424-TR-EM
14 3/8	25	4	RH	SS	See Hub Charts*	MAR-14425-TR-EM
14 3/8	26	4	RH	SS	See Hub Charts*	MAR-14426-TR-EM
14 3/8	27	4	RH	SS	See Hub Charts*	MAR-14427-TR-EM
14 3/8	28	4	RH	SS	See Hub Charts*	MAR-14428-TR-EM
14 3/8	29	4	RH	SS	See Hub Charts*	MAR-14429-TR-EM
14 3/8	30	4	RH	SS	See Hub Charts*	MAR-14430-TR-EM
14 3/8	31	4	RH	SS	See Hub Charts*	MAR-14431-TR-EM
14 3/8	32	4	RH	SS	See Hub Charts*	MAR-14432-TR-EM
2+2TH						
14	16	4	RH	SS	See Hub Charts*	MAR-14416-HR-E0
14	18	4	RH	SS	See Hub Charts*	MAR-14418-HR-E0
14	20	4	RH	SS	See Hub Charts*	MAR-14420-HR-E0
14	22	4	RH	SS	See Hub Charts*	MAR-14422-HR-E0
14	24	4	RH	SS	See Hub Charts*	MAR-14424-HR-E0
14	25	4	RH	SS	See Hub Charts*	MAR-14425-HR-E0
14	26	4	RH	SS	See Hub Charts*	MAR-14426-HR-E0

*Most Turbo propellers "G" series (3.5" gearcase diameter) and up require a Guardian SQ-LOK™ hub kit or similar universal hub system. (sold separately) Please see the "Turbo Hub Application Charts" beginning on page 5-37 to determine your required hub.



Propellers for 4.75" (M/T Series) Gearcases Continued...

Diameter	Pitch	Blades	Rotation	Material	Hub	Part Number
FUSION 4						
14 1/2	21	4	RH	SS	See Hub Charts*	MAR-14421-FR-E0
14 1/2	21	4	LH	SS	See Hub Charts*	MAR-14421-FL-E0
14 1/2	22	4	RH	SS	See Hub Charts*	MAR-14422-FR-E0
14 1/2	22	4	LH	SS	See Hub Charts*	MAR-14422-FL-E0
14 1/2	23	4	RH	SS	See Hub Charts*	MAR-14423-FR-E0
14 1/2	23	4	LH	SS	See Hub Charts*	MAR-14423-FL-E0
14 1/2	24	4	RH	SS	See Hub Charts*	MAR-14424-FR-E0
14 1/2	25	4	RH	SS	See Hub Charts*	MAR-14425-FR-E0
14 1/2	26	4	RH	SS	See Hub Charts*	MAR-14426-FR-E0
ULTIMA 4						
14 1/4	13	4	LH	SS	See Hub Charts*	MAR-14413-UL-E0
14 1/4	15	4	RH	SS	See Hub Charts*	MAR-14415-UR-E0
14 1/4	15	4	LH	SS	See Hub Charts*	MAR-14415-UL-E0
14 1/4	17	4	RH	SS	See Hub Charts*	MAR-14417-UR-E0
14 1/4	17	4	LH	SS	See Hub Charts*	MAR-14417-UL-E0
14 1/4	19	4	RH	SS	See Hub Charts*	MAR-14419-UR-E0
14 1/4	19	4	LH	SS	See Hub Charts*	MAR-14419-UL-E0
14 1/4	21	4	RH	SS	See Hub Charts*	MAR-14421-UR-E0
14 1/4	21	4	LH	SS	See Hub Charts*	MAR-14421-UL-E0
14 1/4	23	4	RH	SS	See Hub Charts*	MAR-14423-UR-E0
14 1/4	23	4	LH	SS	See Hub Charts*	MAR-14423-UL-E0

*Most Turbo propellers "G" series (3.5" gearcase diameter) and up require a Guardian SQ-LOK™ hub kit or similar universal hub system. (sold separately) Please see the "Turbo Hub Application Charts" beginning on page 5-37 to determine your required hub.

Hubs for Yamaha Propellers

Hub Application	Engine Horsepower	Part Number
TRP Front Propellers	TRP Lower Units	65N-45981-00-00
TRP Rear Propellers	TRP Lower Units	6G5-45981-00-00
K Series Propellers	(T50~F115, 70~115)	688-45981-00-00
G Series Propellers	(T25~F60, 50)	663-45981-10-00
ALUMINUM 6E5, 688, 6L6, 6G5, 6K1 Propellers	150hp~300hp	6G5-45981-00-00
6D0, 6D1, 68F, 68G Propellers	150hp~300hp	61A-45981-00-00
66K, 6R1, 6R4, 61A, 61B, 69L, 6G5, 6K1 Propellers	150hp~300hp	61A-45981-00-00
Small Hub Propellers	70hp~200hp	6G5-45981-00-00
6J8 and 664 Propellers	F25, 20~30	664-45981-01-00
N Series Propellers	6,8	6G1-45981-00-00
683 Propellers J Series	9.9, 15, F9.9, T9.9	683-45981-10-00
F350 SDS Propellers	V8	6AW-45C80-00-00
F350 Non-SDS Propellers	V8	6AW-45981-00-00
Reliance / Saltwater Series SDS Propellers	F150~F300 (V6)	6CE-45C81-00-00
Talon Brass Hub	Talon Propellers	6EK-45982-00-00
Talon Rubber Dampers (3 pack)	Talon Propellers	6EK-45C82-09-00



Hubs for Turbo Propellers

Guardian SQ-Lok™ Hub System

A square hub is required for proper installation of Turbo® propellers. Turbo proudly recommends the Guardian SQ-Lok™ Hub System. Guardian SQ-Lok™ hubs are designed to take the punishing power and exhaust heat today's modern marine engines deliver. Unlike some other brands, they feature heavy-duty construction and a nylon center core (drive adaptor) with a molded-in interlocking brass spline insert for extra strength and durability. They're easy to install or replace, and come with the necessary hardware to help get you on the water fast. Demand tough. Demand convenient. Demand a Guardian SQ-Lok™ hub system.



MAR-C014H-UB-00



MAR-C011H-UB-00



MAR-C012H-UB-00



MAR-C013H-UB-00



MAR-D500H-UB-00



MAR-D501H-UB-00



MAR-D506H-UB-00



MAR-D502H-UB-00



MAR-D503H-UB-00



MAR-D504H-UB-00



MAR-D505H-UB-00



MAR-D507H-UB-00

Turbo Hub Application Charts

All Turbo propellers “G” series (3.5” gearcase diameter and up require a Guardian SQ-LOK™ hub kit or similar universal hub system. Use the charts below to find the required hub for your application.

Sterndrive Hub Applications					
Make / Model	Model Notes	Year(s)	Gearcase Diameter	Splines	Hub Part Number
Mercruiser®	1A, 1B, 1C		4.75"	15	MAR-D501H-UB-00
Mercruiser®	120, 140, 145 DTS		4.75"	15	MAR-D501H-UB-00
Mercruiser®	165, 228, 470, 485, 888, 898		4.75"	15	MAR-D501H-UB-00
Mercruiser®	225S, 233, 255TRS		4.75"	15	MAR-D501H-UB-00
Mercruiser®	260, 280TRS, 330TRS		4.75"	15	MAR-D501H-UB-00
Mercruiser®	120-190 HP	1983-1985	4.75"	15	MAR-D501H-UB-00
Mercruiser®	200-260 HP	1983-1985	4.75"	15	MAR-D501H-UB-00
Alpha One®	2.5L - 5.7L	All Years	4.75"	15	MAR-D501H-UB-00
Alpha One®	6.2L MPI	All Years	4.75"	15	MAR-D501H-UB-00
Alpha One®	262, 350, 354 Magnum	All Years	4.75"	15	MAR-D501H-UB-00
Alpha One®	320 EFI	All Years	4.75"	15	MAR-D501H-UB-00
Alpha One®	D2.8L - D7.3L (Diesel)	All Years	4.75"	15	MAR-D501H-UB-00
Bravo One®	320 EFI, 350, 377	All Years	4.75"	15	MAR-D501H-UB-00
Bravo One®	5.0L - 7.4L	All Years	4.75"	15	MAR-D501H-UB-00
OMC™	3.0 L - 8.2 L (Non SX Drive)	1990-1993	4.75"	15	MAR-D502H-UB-00
OMC™ Cobra™	5.8 L	1989-1993	4.75"	15	MAR-D502H-UB-00
Sea Drive™	2.0 L - 4.0 L	All Years	4.75"	15	MAR-D502H-UB-00
OMC™ Model 400	2.3 L (120 HP)	~1991	4.25"	13	MAR-D503H-UB-00
OMC™ Model 400	2.5 L (120 HP)	1978-1984	4.25"	13	MAR-D503H-UB-00
OMC™ Model 400	3.0 L (140 HP)	Thru 1989	4.25"	13	MAR-D503H-UB-00
OMC™ Cobra™	2.3 L (128 HP)	1988-1991	4.25"	13	MAR-D503H-UB-00
OMC™ Cobra™	2.5 L (120 HP)	1985-1987	4.25"	13	MAR-D503H-UB-00
OMC™ Cobra™	3.0 L (140 HP)	1985-1987	4.25"	13	MAR-D503H-UB-00
OMC™ Sea Drive™	1.6 L V-4	1982~	4.25"	13	MAR-D503H-UB-00
OMC™ Sea Drive™	1.8 L V-4	1987~	4.25"	13	MAR-D503H-UB-00
SX COBRA™, VOLVO PENTA® SX	3.0 L	1994 & Newer	4.75"	19	MAR-D504H-UB-00
SX COBRA™, VOLVO PENTA® SX	4.3 L	1994 & Newer	4.75"	19	MAR-D504H-UB-00
SX COBRA™, VOLVO PENTA® SX	5.0 L	1994 & Newer	4.75"	19	MAR-D504H-UB-00
SX COBRA™, VOLVO PENTA® SX	5.7 L	1994 & Newer	4.75"	19	MAR-D504H-UB-00
SX COBRA™, VOLVO PENTA® SX	5.8 L	1994-1997	4.75"	19	MAR-D504H-UB-00
SX COBRA™, VOLVO PENTA® SX	7.4 L	1997 & Newer	4.75"	19	MAR-D504H-UB-00
SX COBRA™, VOLVO PENTA® SX	8.2 L	1997	4.75"	19	MAR-D504H-UB-00
YAMAHA STERNDRIVES	3.0 L (130 HP) EST/PSR	1989-1993	4.75"	15	MAR-D505H-UB-00
YAMAHA STERNDRIVES	4.3 L (205 HP) EST/PSR/YEMS	1989-1993	4.75"	15	MAR-D505H-UB-00
YAMAHA STERNDRIVES	5.0 L (205 HP) EST/PSR/YEMS	1989-1993	4.75"	15	MAR-D505H-UB-00
YAMAHA STERNDRIVES	5.7 L (260 HP) EST/PSR/YEMS	1989-1993	4.75"	15	MAR-D505H-UB-00
YAMAHA STERNDRIVES	7.4 L (300 HP) EST	1992-1993	4.75"	15	MAR-D505H-UB-00

Propellers

MERCURY® 2-Stroke Hub Applications

Horse Power	Model Notes	Years	Gearcase Diameter	Splines	RPM Range	Gear Ratio	Hub Part Number
30 HP	(SeaPro®/Marathon)	1994~	3.25	13	4500-5500	2.00	MAR-C011H-UB-00
30 HP	2-Stroke	1994-2002	3.25	13	4500-5500	2.00	MAR-C011H-UB-00
35 HP		1984-1989	3.25	13	4500-5500	2.00	MAR-C011H-UB-00
40 HP	(Model 402)	1974-1976	3.25	13	4500-5500	2.00	MAR-C011H-UB-00
40 HP	(SeaPro®/Marathon)	1977~	3.25	13	4500-5500	2.00	MAR-C011H-UB-00
40 HP	2-Stroke (Includes Model 402)	1977~	3.25	13	5000-5500	1.83	MAR-C011H-UB-00
45 HP		1986-1989	3.25	13	5000-5500	1.83	MAR-C011H-UB-00
48 HP	(Mariner®)	All Years	3.25	13	5000-5500	1.83	MAR-C011H-UB-00
50 HP	(Model 500)	1974-1976	3.25	13	5000-5500	1.83	MAR-C011H-UB-00
50 HP	2-Stroke (Includes Model 500)	1977~	3.25	13	5000-5500	1.83	MAR-C011H-UB-00
55 HP	(MERCURY®/SeaPro®/Marathon)	1995~	3.25	13	5000-5500	1.83	MAR-C011H-UB-00
60 HP	2-Stroke	1978~	3.25	13	5000-5500	1.64	MAR-C011H-UB-00
60 HP	(SeaPro®/Marathon)	1995~	4.25	15	4500-5500	2.30	MAR-D501H-UB-00
65 HP	(Model 650 - 4 Cyl.)	1961-1970	4.25	15	4500-5500	2.30	MAR-D501H-UB-00
65 HP	(Model 650 - 2 Cyl.)	~1971	4.25	15	4500-5500	2.30	MAR-D501H-UB-00
70 HP		1987-1989	4.25	15	4500-5500	2.30	MAR-D501H-UB-00
70 HP	(Includes Model 700)	~1983	3.25	13	4500-5500	2.30	MAR-C011H-UB-00
75 HP	(SeaPro®/Marathon)	All Years	4.25	15	4750-5250	2.30	MAR-D501H-UB-00
75 HP	Optimax®		4.25	15	5000-5750	2.33	MAR-D501H-UB-00
80 HP	(Mariner®)	1978-1983	4.25	15			MAR-D501H-UB-00
80 HP		1978-1989	4.25	15			MAR-D501H-UB-00
90 HP	2-Stroke	1989-2004	4.25	15	5000-5500	2.30	MAR-D501H-UB-00
90 HP	Optimax®	2005~	4.25	15	5000-5500	2.33	MAR-D501H-UB-00
100 HP		1988~	4.25	15	4750-5250	2.07	MAR-D501H-UB-00
	Models 900 1150 1500	~1977	4.25	15	4750-5250	2.07	MAR-D501H-UB-00
115 HP		1978-1983	4.25	15	4750-5250	2.07	MAR-D501H-UB-00
115 HP	Optimax®	2007~	4.25	15	5000-5700	2.07	MAR-D501H-UB-00
125 HP		1994-2005	4.25	15	4750-5250	2.07	MAR-D501H-UB-00
135 HP		1987~	4.75	15	5000-5600	2.00	MAR-D501H-UB-00
135 HP	Optimax®	1996~	4.75	15	5250-5750	2.00	MAR-D501H-UB-00
140 HP		All Years	4.25	15			MAR-D501H-UB-00
150 HP		1978~	4.75	15	5000-5600	1.87	MAR-D501H-UB-00
150 HP	Optimax®	2004~	4.75	15	5250-5750	1.87	MAR-D501H-UB-00
175 HP		1978~	4.75	15	5000-5600	1.87	MAR-D501H-UB-00
175 HP	Optimax®	2000~	4.75	15	5250-5750	1.87	MAR-D501H-UB-00
200 HP		1978~	4.75	15	5000-5600	1.87	MAR-D501H-UB-00
200 HP	Optimax®	1998~	4.75	15	5000-5750	1.87	MAR-D501H-UB-00
220 HP		1987-1988	4.75	15	5000-5600	1.87	MAR-D501H-UB-00
225 HP		1980~	4.75	15	5000-5750	1.75	MAR-D501H-UB-00
225 HP	Optimax®	1998~	4.75		5000-5750	1.75	MAR-D501H-UB-00
3.4 Litre		1984-1986	4.75	15	5000-5750	1.75	MAR-D501H-UB-00
250 HP	Optimax®	2007~	4.75		5000-5750	1.75	MAR-D501H-UB-00
275 HP		1990-1994	4.75	15	5000-5750	1.75	MAR-D501H-UB-00
300 HP		1983; 1999~	4.75	15	5000-5750	1.75	MAR-D501H-UB-00

MERCURY® 4-Stroke Hub Applications							
Horse Power	Model Notes	Years	Gearcase Diameter	Splines	RPM Range	Gear Ratio	Hub Part Number
25 HP	4-Stroke/Bigfoot	1999-2005	3.5"	13	5250-5750	2.40	MAR-C011H-UB-00
30 HP	4-Stroke	1999-2005	3.5"	13	5500-6000	2.00	MAR-C011H-UB-00
40 HP	4-Stroke (Not Bigfoot)	1997~	3.5"	13	5500-6000	2.00	MAR-C011H-UB-00
40 HP	4-Stroke / Bigfoot	All Years	3.5"	15			MAR-D501H-UB-00
50 HP	4-Stroke (Not Bigfoot)	1995~	3.5"	13	5500-6000	1.83	MAR-C011H-UB-00
50 HP	4-Stroke / Bigfoot	All Years	4.25"	15	5500-6000	2.33	MAR-D501H-UB-00
60 HP	4-Stroke (Not Bigfoot)	2001~	3.25"	13	5500-6000	1.83	MAR-C011H-UB-00
60 HP	4-Stroke / Bigfoot	1995~	4.25"	15	5500-6000	2.33	MAR-D501H-UB-00
75 HP	4-Stroke	2001~	4.25"	15	4500-5500	2.33	MAR-D501H-UB-00
90 HP	4-Stroke	2001~	4.25"	15	5000-6000	2.33	MAR-D501H-UB-00
115 HP	4-Stroke	2001-2006	4.25"	15	5000-6000	2.07	MAR-D501H-UB-00
115 HP	EFI 4-Stroke	2007~	4.25"	15	5800-6400	2.07	MAR-D501H-UB-00
135 HP	Verado®	2007~	4.75"	15	5200-6400	2.08	MAR-D501H-UB-00
150 HP	Verado®	2006~	4.75"	15	5800-6400	2.08	MAR-D501H-UB-00
175 HP	Verado®	2006~	4.75"	15	5800-6400	2.08	MAR-D501H-UB-00
200 HP	Verado®	2005~	4.75"	15	5800-6400	2.08	MAR-D501H-UB-00
225 HP	Verado®	2005~	4.75"	15	5800-6400	1.85	MAR-D501H-UB-00
250 HP	Verado®	2005~	4.75"	15	5800-6400	1.85	MAR-D501H-UB-00
275 HP	Verado®	2005~	4.75"	15	5800-6400	1.85	MAR-D501H-UB-00

Honda® Hub Applications							
Horse Power	Model Notes	Years	Gearcase Diameter	Splines	RPM Range	Gear Ratio	Hub Part Number
35 HP	BF 35	1991-1994	3.5"	13	4600-5600	2.09	MAR-C012H-UB-00
40 HP	BF 40	1995~	3.5"	13	5000-6000	2.09	MAR-C012H-UB-00
45 HP	BF 45	1991-1994	3.5"	13	5000-6000	2.09	MAR-C012H-UB-00
50 HP	BF50/50A	1995~	3.5"	13	5500-6000	2.09	MAR-C012H-UB-00
60 HP	BF 60	2010~	3.5"	13	5000-6000	2.07	MAR-C012H-UB-00
60 HP	BFP 60	2010~	4.25"	15	5000-6000	2.33	MAR-D507H-UB-00
75 HP	BF 75	1995~	4.25"	15	5000-6000	2.33	MAR-D507H-UB-00^^
90 HP	BF 90	1995-2002	4.25"	15	5000-6000	2.33	MAR-D507H-UB-00^^
90 HP	BF 90	2003-2006	4.25"	15	5000-6000	2.30	MAR-D507H-UB-00
90 HP	BF 90	2007~	4.25"	15	5300-6300	2.33	MAR-D507H-UB-00
115 HP	BF 115	1998~	4.25"	15	5000-6000	2.00	MAR-D507H-UB-00
130 HP	BF 130	1998-2004	4.25"	15	5000-6000	2.00	MAR-D507H-UB-00
135 HP	BF 135	2004~	4.25"	15	5000-6000	2.14	MAR-D507H-UB-00
150 HP	BF 150	2004~	4.25"	15	5000-6000	2.14	MAR-D507H-UB-00
200 HP	BF 200	2002~	4.25"	15	5000-6000	1.86	MAR-D507H-UB-00
225 HP	BF 225	2002~	4.25"	15	5000-6000	1.86	MAR-D507H-UB-00

^^ BF75,BF90 (~1998) Use MAR-D501H-UB-00

Propellers

Evinrude® / Johnson® 2-Stroke Hub Applications							
Horse Power	Model Notes	Years	Gearcase Diameter	Splines	RPM Range	Gear Ratio	Hub Part Number
40 HP	E-Tec®	2004~	4.25"	13	5500-6000	2.67	MAR-D503H-UB-00
40 HP	2 Cyl	1984-2005	3.38"	13	4500-5500	2.42	MAR-C012H-UB-00
45 HP	2 Cyl. Commercial	1986-1995	4.25"	13			MAR-D503H-UB-00
48 HP		1987~	3.38"	13			MAR-C012H-UB-00
50 HP	2 Cyl	1975-2005	3.38"	13	4500-5500	2.42	MAR-C012H-UB-00
50 HP	2 Cyl. Commercial	1977-1979	4.25"	13			MAR-D503H-UB-00
50 HP	2 Cyl. Pleasure	1971-1974	4.25"	13			MAR-D503H-UB-00
50 HP	3 Cyl. Pleasure	1994-1998	4.25"	13			MAR-D503H-UB-00
50 HP	E-Tec®	2004~	4.25"	13	5500-6000	2.67	MAR-D503H-UB-00
55 HP		1976-1979	3.38"	13			MAR-C012H-UB-00
55 HP	3 Cyl	1968-1969	4.25"	13			MAR-D503H-UB-00
55 HP	2 Cyl. Commercial	1980~	4.25"	13			MAR-D503H-UB-00
55 HP	E-Tec®	2009~	4.25"	13	5500-6000	2.67	MAR-D503H-UB-00
	Sprint/Formula E	1986-1992	3.38"	13			MAR-C012H-UB-00
60 HP	3 Cyl. Pleasure	1970-1971	4.25"	13			MAR-D503H-UB-00
60 HP	3 Cyl	1986-2001	4.25"	13			MAR-D503H-UB-00
60 HP	E-Tec®	2004~	4.25"	13	5500-6000	2.67	MAR-D503H-UB-00
65 HP	2 Cyl	1980-1985	3.38"	13			MAR-C012H-UB-00
65 HP	3 Cyl. Pleasure	1972-1973	4.25"	13			MAR-D503H-UB-00
65 HP	3 Cyl. Commercial	1984-2001	4.25"	13			MAR-D503H-UB-00
70 HP	3 Cyl. Commercial	1974-2001	4.25"	13			MAR-D503H-UB-00
75 HP	E-Tec®	2004~	4.25"	13	4500-5500	2.00	MAR-D503H-UB-00
75 HP	3 Cyl	1975-1985	3.38"	13			MAR-C012H-UB-00
75 HP	3 Cyl. Pleasure	1975-1984	4.25"	13			MAR-D503H-UB-00
85 HP	V4	1969-1980	4.25"	13			MAR-D503H-UB-00
85 HP	V4	1991-1995	4.25"	13			MAR-D503H-UB-00
88 HP	V4	1981-1996	4.25"	13			MAR-D503H-UB-00
90 HP	V4	1981~	4.25"	13			MAR-D503H-UB-00
90 HP	V6	1995~	4.75"	15			MAR-D502H-UB-00
90 HP	E-Tec® Std. Length	2004~	4.25"	13	4500-5500	2.00 / 2.25	MAR-D503H-UB-00
100 HP	V4	1979-1980	4.25"	13			MAR-D503H-UB-00
100 HP	V4	1989-1993	4.25"	13			MAR-D503H-UB-00
100 HP	V6 Commercial	1984~	4.75"	15			MAR-D502H-UB-00
110 HP	V4	1986-1989	4.25"	13			MAR-D503H-UB-00
112 HP	V4	1994-1996	4.25"	13			MAR-D503H-UB-00
115 HP	E-Tec® (Includes H.O.)	2004~	4.25"	13	4500-5500	2.00 / 2.25	MAR-D503H-UB-00
115 HP	V6	1995~	4.75"	15			MAR-D502H-UB-00
115 HP	V4	1973~	4.25"	13			MAR-D503H-UB-00
120 HP	V4	1986-1994	4.25"	13			MAR-D503H-UB-00
120 HP	V6	1985	4.75"	15			MAR-D502H-UB-00
125 HP	V4	1971-1972	4.25"	13			MAR-D503H-UB-00
130 HP	V6	1995~	4.75"	15			MAR-D502H-UB-00
130 HP	E-Tec®	2004~	4.25"	13	5500-6000	2.00 / 2.25	MAR-D503H-UB-00
135 HP	V4	1973-1976	4.25"	13			MAR-D503H-UB-00
140 HP	V4	1977-1994	4.25"	13			MAR-D503H-UB-00

Evinrude® / Johnson® 2-Stroke Hub Applications Continued...							
Horse Power	Model Notes	Years	Gearcase Diameter	Splines	RPM Range	Gear Ratio	Hub Part Number
140 HP	V6	1985	4.75"	15			MAR-D502H-UB-00
140 HP	V6 (25")	1989-1994	4.75"	15			MAR-D502H-UB-00
150 Hp	E-Tec®	2009~	4.75"	15	4850-5850	1.86	MAR-D502H-UB-00
150 HP	V6	1978~	4.75"	15	4500-5500	1.86	MAR-D502H-UB-00
150 HP	V6 Commercial	1995~	4.75"	15			MAR-D502H-UB-00
155 HP	Commercial	1978~	4.75"	15			MAR-D502H-UB-00
175 Hp	E-Tec®	2008~	4.75"	15	4850-5850	1.86	MAR-D502H-UB-00
175 HP	V6	1977~	4.75"	15	5300-5800	1.86	MAR-D502H-UB-00
185 HP	V6	1984-1985	4.75"	15			MAR-D502H-UB-00
2.6 Liter	V6	1984-1985	4.75"	15			MAR-D502H-UB-00
3.6 Liter	V6	1986-1987	4.75"	15			MAR-D502H-UB-00
200 HP	V6	1976~	4.75"	15	5000-6000	1.86	MAR-D502H-UB-00
200 Hp	E-Tec®	2006~	4.75"	15	4500-5800	1.86	MAR-D502H-UB-00
225 HP	E-Tec®	2006~	4.75"	15	4500-5800	1.86	MAR-D502H-UB-00
225 HP	E-Tec® H.O.	2009~	4.75"	15	4500-5800	1.71	MAR-D502H-UB-00
225 HP	V6	1986~	4.75"	15	5000-6000	1.86	MAR-D502H-UB-00
235 HP	V6	1978-1985	4.75"	15	5000-6000	1.86	MAR-D502H-UB-00
250 HP	V6	1991~	4.75"	15	5000-6000	1.86	MAR-D502H-UB-00
250 HP	E-Tec®	2006~	4.75"	15	4500-5800	1.85	MAR-D502H-UB-00
250 HP	E-Tec® H.O.	2008~	4.75"	15	4500-6000	1.71	MAR-D502H-UB-00
275 HP	V8	1986-1988	4.75"	15	5000-6000	1.86	MAR-D502H-UB-00
300 HP	V8	1988-1995	4.75"	15	5000-6000	1.86	MAR-D502H-UB-00
300 HP	E-Tec®	2009~	4.75"	15	5000-6000	1.86	MAR-D502H-UB-00

Evinrude® / Johnson® 4-Stroke Hub Applications							
Horse Power	Model Notes	Years	Gearcase Diameter	Splines	RPM Range	Gear Ratio	Hub Part Number
40 HP	4-Stroke	1999-2005	3.5"	13	5200-5800	2.27	MAR-C011H-UB-00
50 HP	4-Stroke	1999-2005	3.25"	13	5200-5800	2.27	MAR-C011H-UB-00
60 HP	4-Stroke	1998~	4.25"	13	4700-5300	2.42	MAR-D503H-UB-00
70 HP	4-Stroke	1998~	4.25"	13	5200-5800	2.42	MAR-D503H-UB-00
90 HP	4-Stroke	2003~	4.25"	15	4500-5500	2.59	MAR-D509H-UB-00
115 HP	4-Stroke	2003~	4.25"	15	5000-6000	2.59	MAR-D509H-UB-00
140 HP	4-Stroke	2003~	4.25"	15	5600-6200	2.38	MAR-D501H-UB-00
200 HP	4-Stroke	2004-2005	4.75"	15	5000-6000	2.29	MAR-D502H-UB-00
225 HP	4-Stroke	2004-2005	4.75"	15	5000-6000	2.29	MAR-D502H-UB-00

Propellers

Suzuki® Hub Applications

Horse Power	Model Notes	Years	Gearcase Diameter	Splines	RPM Range	Gear Ratio	Hub Part Number
DT 35C		1987-1989	3.5"	13			MAR-C011H-UB-00
DT 40		1983-1998	3.5"	13			MAR-C011H-UB-00
DF 40	4-Stroke	1999-2010	3.5"	13	5200-5800	2.27	MAR-C011H-UB-00
DF 40A	4-Stroke	2011~	3.5"	13	5000-6000	2.27	MAR-C011H-UB-00
DT 50		1983-1984	3.5"	13			MAR-C011H-UB-00
DT 50M		1983-1984	3.5"	13			MAR-C011H-UB-00
DF 50	4-Stroke	1999-2010	3.5"	13			MAR-C011H-UB-00
DF 50A	4-Stroke	2011~	3.5"	13			MAR-C011H-UB-00
DT 55		1985-1997	3.5"	13			MAR-C011H-UB-00
DT 60		1983-1984	3.5"	13			MAR-C011H-UB-00
DF 60A	4-Stroke	2010~	3.5"	13	5300-6300	2.27	MAR-C011H-UB-00
DF 60	4-Stroke	1998-2009	4.25"	13	4700-5300	2.42	MAR-C011H-UB-00
DT 65		1985-1997	3.5"	13			MAR-C011H-UB-00
DF 70	4-Stroke	1998-2008	4.25"	13	5200-5800	2.42	MAR-C011H-UB-00
DF 70A	4-Stroke	2009~	4.25"	15	5000-6000	2.59	MAR-D509H-UB-00
DT 75		1983-1997	4.25"	13			MAR-D506H-UB-00
DF 80A	4-Stroke	2009~	4.25"	15	5000-6000	2.59	MAR-D509H-UB-00
DT 85		1979-2000	4.25"	13			MAR-D506H-UB-00
DT 90		1989-1997	4.25"	13			MAR-D506H-UB-00
DF 90	4-Stroke	2001-2008	4.25"	15	4500-5500	2.59	MAR-D509H-UB-00
DF 90A	4-Stroke	2009~	4.25"	15	5300-6300	2.59	MAR-D509H-UB-00
DT 100		1989-2000	4.25"	13			MAR-D506H-UB-00
DF 100	4-Stroke	2009~	4.25"	15			MAR-D509H-UB-00
DT 115		1981-2001	4.25"	13			MAR-D506H-UB-00
DF 115	4-Stroke	2001~	4.25"	15	5000-6000	2.59	MAR-D509H-UB-00
DT 140		1981-2001	4.25"	13			MAR-D506H-UB-00
DF 140	4-Stroke	2002~	4.25"	15	5600-6200	2.59	MAR-D501H-UB-00
DT 150		1986-2003	4.75"	15			MAR-D507H-UB-00
DF 150	4-Stroke	2006~	4.75"	15	5000-6000	2.50	MAR-D507H-UB-00
DT 175		1987-1992	4.75"	15			MAR-D507H-UB-00
DF 175	4-Stroke	2006~	4.75"	15	5500-6100	2.50	MAR-D507H-UB-00
DT 200		1986-2000	4.75"	15			MAR-D507H-UB-00
DF 200	4-Stroke	2004~	4.75"	15	5000-6000	2.29	MAR-D507H-UB-00
DT 225		1986-2003	4.75"	15			MAR-D507H-UB-00
DF 225	4-Stroke	2004~	4.75"	15	5000-6000	2.29	MAR-D507H-UB-00
DF 250	4-Stroke	2004~	4.75"	15	5500-6100	2.29	MAR-D507H-UB-00
DF 300	4-Stroke	2007~	4.75"	15	5700-6300	2.08	MAR-D507H-UB-00

Force® Hub Applications							
Horse Power	Model Notes	Years	Gearcase Diameter	Splines	RPM Range	Gear Ratio	Hub Part Number
40 HP		1995-1998	3.5"	13			MAR-C011H-UB-00
50 HP		1995-1998	3.5"	13			MAR-C011H-UB-00
70 HP		1991-1995	3.5"	13			MAR-C011H-UB-00
75 HP		1996-1998	3.5"	13			MAR-C011H-UB-00
75 HP		1999~	4.25"	15			MAR-D501H-UB-00
85 HP		1988-1989	4.25"	15			MAR-D501H-UB-00
90 HP	L-Drive	1989-1991	4.25"	15			MAR-D501H-UB-00
90 HP		1995-1996	4.25"	15			MAR-D501H-UB-00
90 HP	L-Drive	1990-1991	4.25"	15			MAR-D501H-UB-00
90 HP		1990-1994	4.25"	15			MAR-D501H-UB-00
120 HP	L-Drive	1989-1991	4.25"	15			MAR-D501H-UB-00
120 HP		1995-1996	4.25"	15			MAR-D501H-UB-00
120 HP	L-Drive	1990-1991	4.25"	15			MAR-D501H-UB-00
120 HP		1990-1994	4.25"	15			MAR-D501H-UB-00
125 HP		1988-1989	4.25"	15			MAR-D501H-UB-00
150 HP		1989-1994	4.25"	15			MAR-D501H-UB-00
150 HP	L-Drive	1991	4.25"	15			MAR-D501H-UB-00
150 HP		1989-1994	4.25"	15			MAR-D501H-UB-00
150 HP	L-Drive	1991	4.25"	15			MAR-D501H-UB-00

Nissan® / Tohatsu® Hub Applications							
Horse Power	Model Notes	Years	Gearcase Diameter	Splines	RPM Range	Gear Ratio	Hub Part Number
35 HP	(35B Only)	~1984	3.5"	13			MAR-C013H-UB-00
40 HP	40D	1984~	3.5"	13	4500-5500	1.85	MAR-C013H-UB-00
40 HP	TLDI®	2003~	3.5"	13	5150-5850	1.85	MAR-C013H-UB-00
50 HP	50C	1987-1999	3.5"	13	5000-5700	1.85	MAR-C013H-UB-00
50 HP	includes TLDI®	2000~	3.5"	13	5150-5850	1.85	MAR-C013H-UB-00
55 HP		1981-1988	3.5"	13			MAR-C013H-UB-00
60A		1986-1999	3.5"	13			MAR-C013H-UB-00
60C	(Large Gearcase)	~1999	4.25"	15			MAR-D505H-UB-00
70 HP	70A and 70B	1981-1995	3.5"	13			MAR-C013H-UB-00
70 HP		1992-1997	4.25"	15	4900-5600	2.30	MAR-D505H-UB-00
70 HP	TLDI®	1998~	4.25"	15	5150-5850	2.30	MAR-D505H-UB-00
75 HP	TLDI®	2010~	4.25"	15	5150-5850	2.33	MAR-D505H-UB-00
90 HP		1987-1999	4.25"	15	5000-5500	2.00	MAR-D505H-UB-00
90 HP	TLDI®	2000-2009	4.25"	15	5150-5850	2.00	MAR-D505H-UB-00
90 HP	TLDI®	2010~	4.25"	15	5150-5850	2.33	MAR-D505H-UB-00
115 HP		1992-2002	4.25"	15	5200-5700	2.00	MAR-D505H-UB-00
115 HP	TLDI®	2003~	4.25"	15	5150-5850	2.00	MAR-D505H-UB-00
120 HP		1988-2003	4.25"	15	5200-5700	2.00	MAR-D505H-UB-00
140 HP		1988-2003	4.25"	15	5200-5700	2.00	MAR-D505H-UB-00

Propellers

General Information

Rigging Estimate Guide (Diagrams)

Rigging Components

Electrical Components

Engine Accessories

Propellers

Maintenance Items

Oils & Lubes

Detailing & Trailer Supplies

Accessories & Apparel

Generators & Accessories

Yamaha 2-Stroke Hub Applications							
Horse Power	Model Notes	Years	Gearcase Diameter	Splines	RPM Range	Gear Ratio	Hub Part Number
40 HP	2 Stroke	1984~	3.5"	13	4500-5500	1.85	MAR-C014H-UB-00
48 HP	2 Stroke	1995-2000	3.5"	13	4500-5500	1.85	MAR-C014H-UB-00
50 HP	2 Stroke	1984~	3.5"	13	4500-5500	1.85	MAR-C014H-UB-00
55 HP	2 Stroke	~1995	3.5"	13	4500-5500	1.84	MAR-C014H-UB-00
60 HP	2 Stroke	~1991	3.5"	13	4500-5500	2.33	MAR-C014H-UB-00
60 HP	2 Stroke	1992-2005	4.25"	15	4500-5500	2.00	MAR-D500H-UB-00
70 HP	2 Stroke	2000~	4.25"	15	4500-5500	2.33	MAR-D500H-UB-00
75 HP	2 Stroke	1994-1999	4.25"	15	4500-5500	2.00	MAR-D500H-UB-00
80 HP	2 Stroke	1997	4.25"	15	4500-5500	2.00	MAR-D500H-UB-00
85 HP	2 Stroke	1991-1997	4.25"	15	4500-5500	2.00	MAR-D500H-UB-00
90 HP	2 Stroke	1984~	4.25"	15	4500-5500	2.00	MAR-D500H-UB-00
115 HP	2 Stroke	1984~	4.25"	15	4500-5500	2.00	MAR-D505H-UB-00
130 HP	2 Stroke	1984-2003	4.25"	15	4500-5500	2.00	MAR-D505H-UB-00
150 HP	2 Stroke	1986~	4.75"	15	4500-5500	2.00	MAR-D505H-UB-00
175 HP	2 Stroke	1984~	4.75"	15	4500-5500	1.86	MAR-D505H-UB-00
200 HP	2 Stroke	1984~	4.75"	15	4500-5500	1.86	MAR-D505H-UB-00
220 HP	(Special)	1984-1985	4.75"	15	4500-5500	1.75	MAR-D505H-UB-00
225 HP	2 Stroke	1986~	4.75"	15	4500-5500	1.75	MAR-D505H-UB-00
225 HP	(Excel) 2 Stroke	1987-1988	4.75"	15	4500-5500	1.75	MAR-D505H-UB-00
250 HP	2 Stroke	1990~	4.75"	15	4500-5500	1.75	MAR-D505H-UB-00
2.6L	VMAX® 2 Stroke	2001~	4.75"	15	4500-5500	1.86	MAR-D505H-UB-00
3.3L	VMAX® 2 Stroke	2001~	4.75"	15	4500-5500	1.75	MAR-D505H-UB-00

Yamaha 4-Stroke Hub Applications							
Horse Power	Model Notes	Years	Gearcase Diameter	Splines	RPM Range	Gear Ratio	Hub Part Number
T25	4-Stroke		3.5"	13	5000-6000		MAR-C014H-UB-00
F30	4-Stroke	2001-2005	3.5"	13	5000-6000	2.00	MAR-C014H-UB-00
F40	4-Stroke	1999~	3.5"	13	5000-6000	2.00	MAR-C014H-UB-00
F50	4-Stroke	1995~	3.5"	13	5000-6000	1.85	MAR-C014H-UB-00
T50	4 Stroke	1996~	4.25"	15	5000-6000	2.33	MAR-D500H-UB-00
F60	4-Stroke	1999~	3.5"	13	5000-6000	1.85	MAR-C014H-UB-00
T60	4-Stroke	1999~	4.25"	15	5000-6000	2.33	MAR-D500H-UB-00
F70	4-Stroke	2010~	4.25"	15	5300-6300	2.33	MAR-D500H-UB-00
F75	4-Stroke	2003~	4.25"	15	5000-6000	2.31	MAR-D500H-UB-00
F80	4-Stroke	1999-2002	4.25"	15	5000-6000	2.31	MAR-D500H-UB-00
F90	4-Stroke	1999~	4.25"	15	5000-6000	2.00	MAR-D500H-UB-00
F100	4-Stroke	1999-2002	4.25"	15	5000-6000	2.31	MAR-D500H-UB-00
F115	4-Stroke	2000~	4.25"	15	5000-6000	2.15	MAR-D505H-UB-00
F150	4-Stroke	2004~	4.75"	15	5000-6000	2	MAR-D505H-UB-00
F200	4-Stroke	2002~	4.75"	15	5000-6000	2	MAR-D505H-UB-00
VF200	V MAX® SHO® 4 Stroke	2010~	4.75"	15	5000-6000	1.75	MAR-D505H-UB-00

Yamaha 4-Stroke Hub Applications Continued...							
Horse Power	Model Notes	Years	Gearcase Diameter	Splines	RPM Range	Gear Ratio	Hub Part Number
F225	4-Stroke	2002~	4.75"	15	5000-6000	2	MAR-D505H-UB-00
VF225	V MAX® SHO® 4 Stroke	2010~	4.75"	15	5000-6000	1.75	MAR-D505H-UB-00
F225	4 Stroke Offshore	2010~	4.75"	15	5000-6000	1.75	MAR-D505H-UB-00
F250	4-Stroke	2002~	4.75"	15	5000-6000	2.00	MAR-D505H-UB-00
F250	4 Stroke Offshore	2010~	4.75"	15	5000-6000	1.75	MAR-D505H-UB-00
VF250	V MAX® SHO® 4 Stroke	2010~	4.75"	15	5000-6000	1.75	MAR-D505H-UB-00
F300	4 Stroke Offshore	2010~	4.75"	15	5000-6000	1.75	MAR-D505H-UB-00

General Information

Rigging Estimate Guide (Diagrams)

Rigging Components

Electrical Components

Engine Accessories

Propellers

Maintenance Items

Oils & Lubes

Detailing & Trailer Supplies

Accessories & Apparel

Generators & Accessories

Propellers

Propeller Hardware Kits



6G5-W4599-00-00

Castle Nut	90171-18M04-00
Cotter Pin	91490-40030-00
Rear Spacer	688-45997-01-00
Washer	92990-18200-00



6H1-W4599-00-00

Castle Nut	90171-16011-00
Cotter Pin	91490-30030-00
Rear Spacer	688-45997-01-00
Washer	90201-17M00-00



6H4-W4599-00-00

Castle Nut	90171-16011-00
Cotter Pin	91490-30030-00
Rear Spacer	670-45997-02-00
Washer	92990-16200-00



66T-W4599-00-00

Bushing	90389-22M01-00
Rear Spacer	66T-45997-00-00
Cotter Pin	91490-30030-00
Castle Nut	90171-16011-00



67F-W4599-00-00

Castle Nut	90171-16011-00
Bushing	90389-25M00-00
Rear Spacer	67F-45997-00-00
Cotter Pin	91490-40030-00



647-W4599-00-00

Propeller Nut	647-45616-02-00
Cotter Pin	91490-30030-00



689-W4599-00-00

Castle Nut	90171-14013-00
Rear Spacer	689-45997-00-00
Cotter Pin	91490-30030-00
Washer	92990-14200-00

4-Stroke Propeller Hardware Kit Application	Kit Part Number
F25	689-W4599-00-00
F30, F40 (00~), F40LA	66T-W4599-00-00
F40 (99)	6H4-W4599-00-00
F50 (01~)	66T-W4599-00-00
F50 (95~00)	6H4-W4599-00-00
T50 (96~00)	6H1-W4599-00-00
T50 (01~)	67F-W4599-00-00
F60 (03~)	66T-W4599-00-00
T60 (03~)	67F-W4599-00-00
F70	67F-W4599-00-00
F75, F90 (03~)	67F-W4599-00-00
F80, F100	67F-W4599-00-00
F115~F300(4.2L)	6G5-W4599-00-00
VF115~VF250	6G5-W4599-00-00

2-Stroke Propeller Hardware Kit Application	Kit Part Number
4, 5 (84~91)	647-W4599-00-00
20,25, C25, CV25, 30, C30, CV30	689-W4599-00-00
40 (84~01), P40, P50, Pro50	6H4-W4599-00-00
C40, C50, C55, CV40, CV55, E48	6H4-W4599-00-00
50	6H4-W4599-00-00
60~90 (~03)	6H1-W4599-00-00
60~90 (04~)	67F-W4599-00-00
C60~C90, E60, P60, E75, P75	6H1-W4599-00-00
CV85, B90	6H1-W4599-00-00
B115	6G5-W4599-00-00
115~250, C115, C150	6G5-W4599-00-00
P115~P200, PX175	6G5-W4599-00-00
S115~S250	6G5-W4599-00-00
D150, DX150, ProV150	6G5-W4599-00-00
SX150~SX250, V150~V225	6G5-W4599-00-00
VX150~VX250	6G5-W4599-00-00
VZ150~VZ300	6G5-W4599-00-00
Z150~Z300	6G5-W4599-00-00

Propeller Accessories

Prop Lock

Helps protect your propeller investment. Easy-to install and cost effective. Does not interfere with operation (i.e., motor can be used with a lock installed). Suitable for use on regular and counter rotating props. Fits 40 ~ 90

MAR-PROPL-CK-01



Propeller Cover

Constructed of 600D, solution-dyed polyester for durability and fade resistance

MAR-PROPB-AG-BK



TRP Front Prop Wrench

Designed to fit both propeller nuts on the D150 and DX150 models. (Not shown)

65N-28161-00-00

“Old Style” SDS Spacers

Required for installing a SDS propeller on engines with non SDS propellers installed or equipped with non a SDS spacer in the engine crate.

V8: 6AW-45997-10-00

V6: 6CE-45997-00-00

F150: 6CE-45997-00-00



Two Piece Thrust Washer:

Used in place of a standard thrust washer on most VZ and VF engines.

99999-03848-00

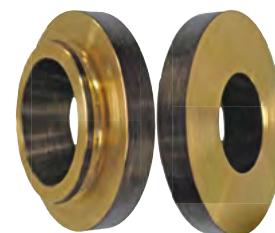

General Information

Rigging Estimate Guide (Diagrams)

Rigging Components

Electrical Components

Engine Accessories

Propellers

Maintenance Items

Oils & Lubes

Detailing & Trailer Supplies

Accessories & Apparel

Generators & Accessories



Description	Page
Maintenance Capacities Chart	7-1
4-Stroke Spark Plugs	7-3
2-Stroke Spark Plugs	7-5
4-Stroke Oil Filters	7-6
2-Stroke Oil Strainers	7-7
In Line Fuel Filters	7-8
Primary Fuel Filters	7-9
Remote Mounted Fuel Filters	7-11
Vapor Separator Tank (VST) Filters	7-12
VST Gaskets	7-13
Engine Timing Belts	7-14
Trim Tabs	7-15
Anodes	7-16
Thermostats	7-17
Thermostat Gaskets	7-18
4-Stroke Carburetor Kits	7-19
2-Stroke Carburetor Kits	7-23
Water Pump Housings	7-29
4-Stroke Water Pump Repair Kits	7-30
2-Stroke Water Pump Repair Kits	7-34

General
Information

Rigging Estimate
Guide (Diagrams)

Rigging
Components

Electrical
Components

Engine
Accessories

Propellers

**Maintenance
Items**

Oils
& Lubes

Detailing &
Trailer Supplies

Accessories
& Apparel

Generators
& Accessories

Maintenance Items

Maintenance Capacities Chart

Model	Production Year	Oil Change Capacity:	Oil Filter Part #	(NGK®) Spark Plug	5W30 4M	10W30 4M	20W40 4M	Gear Case Capacity in Ounces
F2.5	2005~	10 US OZ.	N/A	BR6HS-10	✓	✓	✓	2.5
F4	2005~	17 US OZ.	N/A	BR6HS-10	✓	✓	✓	3.5
F4A / F6A	2010~	20 US OZ	N/A	CR6HSB7	✓	✓	✓	4.0
F6 / F8C / T8D	2005~	27 US OZ.	N/A	BR6HS-10	✓	✓	✓	F6 / F8 = 5.1 T8 = 12.5
New F8 "S"	2015~	27 US OZ	N/A	BR6HS-10	✓	✓	✓	5.1
New F8 "L"	2015~	27 US OZ	N/A	BR6HS-10	✓	✓	✓	5.1
F9.9F / T9.9G	2008~	27 US OZ.	N/A	BR6HS-10	✓	✓	✓	F9.9F = 5.1 T9.9G = 12.5
F15C / F20	2007~	1.9 US QT	5GH-13440-60-00	DPR6EA-9	✓	✓	✓	8.5
F25A / T25A	2009~	1.7 US QT	5GH-13440-60-00	DPR6EA-9	✓	✓	✓	F25 = 11 T25 = 15
F25	2017~	1.2 US QT	5GH-13440-60-00	DPR6EB-9	✓	✓	✓	F25 = 11
F40A	2009~	1.8 US QT	5GH-13440-60-00	DPR6EB-9	✓	✓	✓	15
F50 / T50 / F60 / T60	2005~	2.2 US QT	5GH-13440-60-00	DPR6EB-9	✓	✓	✓	F50 / F60 = 14.5 T50 / T60 = 22.7
F70LA	2010~	2.2 US QT	5GH-13440-60-00	LKR7E	✓	✓	✓	22.7
F75 / F90	2005~	3.9 US QT	5GH-13440-70-00	LFR5A-11	✓	✓	✓	22.7
F90B	2016~	3.4 US QT	5GH-13440-70-00	LKR6E	✓	✓	✓	26
VF90	2017	3.4 US QT	5GH-13440-70-00	LKR6E	✓	✓	✓	26
F115	2000~	3.9 US QT	5GH-13440-70-00	LFR6A-11	✓	✓	✓	RH Rotation = 25.7 LH Rotation = 24.2
F115	2014~	3.38 US QT	5GH-13440-70-00	LKR6E	✓	✓	✓	RH Rotation = 25.7 LH Rotation = 24.2
VF115	2015~	3.38 US QT	5GH-13440-70-00	LKR6E	✓	✓	✓	25.7
F150	2004~	4.7 US QT	69J-13440-03-00	LFR5A-11	✓	✓	✓	RH Rotation = 33.1 LH Rotation = 29.4
F150B	2015~	4.8 US QT	69J-13440-03-00	LFR5A-11	✓	✓	✓	RH Rotation = 33.1 LH Rotation = 29.4
VF150	2013~	4.8 US QT	69J-13440-03-00	LFR6A-11	✓	✓	⊘	33.1
F175	2014~	4.8 US QT	69J-13440-03-00	LFR6A-11	✓	✓	✓	33.2
VF175	2015~	4.8 US QT	69J-13440-03-00	LFR6A-11	✓	✓	⊘	33.1

This chart is provided for reference only, always refer to the proper service manual for the most accurate information.

Maintenance Capacities Chart

Model	Production Year	Oil Change Capacity:	Oil Filter Part #	(NGK®) Spark Plug	5W30 4M	10W30 4M	20W40 4M	Gear Case Capacity in Ounces
F200 (Inline 4 Cyl)	2013~	4.7 US QT	69J-13440-03-00	LFR6A-11	✓	✓	✓	RH Rotation = 33.2 LH Rotation = 33.2
F200 / F225 (V6)	2002~	5.0 US QT	69J-13440-03-00	LFR5A-11	✓	✓	✓	RH Rotation = 38.9 LH Rotation = 33.8
VF200 / VF225 / VF250	2010~	7.1 US QT	N26-13440-02-00	LFR6A-11	✓	✓	⊘	36
VF250XA	2015~	7.1 US QT	N26-13440-02-00	LFR6A-12	✓	✓	⊘	35.2
F225CA / F250CA / F300CA	2010~	6.7 US QT	N26-13440-02-00	LFR6A-11	✓	✓	✓	35.2
F225 Sport	2008~	5.0 US QT	69J-13440-03-00	LFR6A-11	✓	✓	✓	31.1
F250 (A & B)	2005~	5.0 US QT	69J-13440-03-00	LFR6A-11	✓	✓	✓	RH Rotation = 31.1 LH Rotation = 27.2
F300 / F350	2008~	6.8 US QT	N26-13440-02-00	LFR6A-11	✓	✓	✓	RH Rotation = 51.4 LH Rotation = 44.3
XTO® 425	2018~	8.2 US QT	N26-13440-02-00	ILMAR7E9	✓	✓	✓	RH Rotation = 65.9 LH Rotation = 61.8

General Information

Rigging Estimate Guide (Diagrams)

Rigging Components

Electrical Components

Engine Accessories

Propellers

Maintenance Items

Oils & Lubes

Detailing & Trailer Supplies

Accessories & Apparel

Generators & Accessories

4-Stroke Spark Plugs

Four Stroke Model	NGK® Number	Gap (mm)	Gap (in)	Yamaha Part Number
F2.5, F4	B6HS	0.6	0.024	B6HS0000000
F4A, F6A	CR6HSB	0.7	0.028	CR6HSB000000
F6	BR6HS-10	1.0	0.04	BR6HS1000000
F8, T8, New F8	BR6HS-10	1.0	0.04	BR6HS1000000
New F8 "L"	BR6HS-10	1.0	0.039	BR6HS1000000
F9.9/FT9.9/T9.9 (85~03) cold climates	CR4HSA	0.6	0.024	CR4HSA000000
F9.9/FT9.9/T9.9 (85~04)	CR6HS	0.6	0.024	CR6HS0000000
F9.9, T9.9, FT9.9 (05~)	DPR6EA-9	0.8	0.032	DPR6EA900000
F9.9F, T9.9G	BR6HS-10	1.0	0.04	BR6HS1000000
F15	DPR6EA-9	0.8	0.032	DPR6EA900000
F20, F15C	DPR6EB-9	0.9	0.036	DPR6EB900000
F25 (98~05)	DPR6EA-9	1.0	0.039	DPR6EA900000
T25 (06~), F25 (06~), F30 (01~05)	DPR6EA-9	0.9	0.036	DPR6EA900000
F25A, T25A	DPR6EB-9	0.9	0.036	DPR6EB900000
F25C	DPR6EB-9	0.9	0.036	DPR6EB900000
F40	DPR6EA-9	0.9	0.036	DPR6EA900000
F40A	DPR6EB-9	0.9	0.036	DPR6EB900000
F50/T50 (95~04), F60/T60 (~04)	DPR6EA-9	0.9	0.036	DPR6EA900000
F50/T50 (05~), F60/T60 (05~)	DPR6EB-9	0.9	0.036	DPR6EB900000
F70A	LKR7E	0.9	0.035	LKR7E0000000
F75, F80, F90, F100	LFR5A-11	1.1	0.044	LFR5A1100000
F90B	LKR6E	0.9	0.035	LKR6E0000000
VF90	LKR6E	0.9	0.035	LKR6E0000000
F115, LF115	LFR6A-11	1.1	0.044	LFR6A1100000
F115	LKR6E	0.9	0.035	LKR6E0000000
VF115	LKR6E	0.9	0.035	LKR6E0000000
F150, F150B ,	LFR5A-11	1.0	0.039	LFR5A1100000
VF150, F175, VF175, F200 (inline)	LFR6A-11	1.1	0.043	LFR6A1100000
F200, F225 (V6)	LFR5A-11	1.0	0.04	LFR5A1100000



NGK® Spark Plugs are used in all of the Yamaha Outboards you service through out the year. Since 1936 NGK® has lead the industry in technology, innovation and world class design of its entire product line. You can depend on NGK® for quality and reliability.

4-Stroke Spark Plugs

Four Stroke Model	NGK® Number	Gap (mm)	Gap (in)	Yamaha Part Number
VF200, VF225, VF250	LFR6A-11	1.1	0.043	LFR6A1100000
New VF250"X"	LFR6A-11	1.1	0.043	LFR6A1100000
F250, LF250, F250B, LF250B	LFR6A-11	1.1	0.044	LFR6A1100000
4.2L- F225, LF225, F250, LF250, F300, LF300	LFR6A-11	1.1	0.043	LFR6A1100000
V8- F300, LF300, F350, LF350	LFR6A-11	1.1	0.044	LFR6A1100000
XTO® 425	ILMARE9	N/A	N/A	LMAR7E900000

NGK® Spark Plugs are used in all of the Yamaha Outboards you service through out the year. Since 1936 NGK® has lead the industry in technology, innovation and world class design of its entire product line. You can depend on NGK® for quality and reliability.



General Information

Rigging Estimate Guide (Diagrams)

Rigging Components

Electrical Components

Engine Accessories

Propellers

Maintenance Items

Oils & Lubes

Detailing & Trailer Supplies

Accessories & Apparel

Generators & Accessories

Maintenance Items

2-Stroke Spark Plugs

Two Stroke Model	NGK® Number	Gap (mm)	Gap (in)	Yamaha Part Number
2	B5HS	0.6	0.024	B5HS0000000
3	B6HS-10	0.9	0.036	B6HS1000000
4, 5	B7HS	0.6	0.024	B7HS1000000
6, 8	B7HS-10	0.9	0.036	B7HS1000000
9.9, 15, 20, 25	B7HS-10	1	0.04	B7HS0000000
C25 (90~97), 30 (84~86), C30 (89~92)	B7HS	0.6	0.024	B7HS0000000
30 (87~02)	B7HS-10	1	0.04	B7HS1000000
C30 (93~97)	B8HS-10	1	0.04	B8HS1000000
40 (84 ~ 05), C40 (97 ~ 02)	B7HS-10	1	0.04	B7HS1000000
C40 (89~97)	B8HS	0.6	0.024	B8HS0000000
E48 (95~00)	B7HS	1	0.04	B7HS0000000
50, P50, C55	B8HS-10	1	0.04	B8HS1000000
C50	B8HS	0.6	0.024	B8HS0000000
60, C60, E60, P60, 70, C70, C75, E75, P75	B8HS-10	1	0.04	B8HS1000000
C80, C85, 90, B90, C90	B8HS-10	1	0.04	B8HS1000000
115, B115, C115, P115, S115	BR8HS-10	1	0.04	BR8HS1000000
130, L130, S130	BR9HS-10	1	0.04	BR9HS1000000
150 (~87), 150 / SX150 / LX150 (96~), S150 (99~)	BR7HS-10	1	0.04	BR7HS1000000
C150 (96), DX (99~), P150(96~), PX150, V150 (00~)	BR7HS-10	1	0.04	BR7HS1000000
150 / L150 (88~95), C150 (97~)	BR8HS-10	1	0.04	BR8HS1000000
D150 (97~99), P150 (86~95)	BR8HS-10	1	0.04	BR8HS1000000
VZ150 (~01), Z150 / LZ150 (~01)	BKR6ES-11	Note 2	Note 2	BKR6ES110000
VZ150 (01~), Z150 / LZ150 (01~)	BKR6E-KU	Note 2	Note 2	BKR6EKU10000
175, S175, V175, P175	BR8HS-10	1	0.04	BR8HS1000000
VZ175 (01~), Z175/LZ175 (01~), Z200/LZ200 (01~)	BKR7E-KU	Note 2	Note 2	BKR7EKU10000
VZ175 (01), Z175 / LZ175 (01), Z200 / LZ200 (~01)	BKR7ES-11	Note 2	Note 2	BKR7ES114000
200, S200, SX200, LX200, V200, VX200, P200 (96 ~)	BR8HS-10	1	0.04	BR8HS1000000
VZ200 (05~) VZ225, VZ250, VZ300	BKR6E-KU	Note 3	Note 3	BKR6EKU10000
225 2.6L (~95), L225/S225 3.L (97~), LX225/SX225	BR9HS-10	1	0.04	BR9HS1000000
225/L225 3.1L (~96), S225 3.1L (96), 225 2.6L (96~)	BR8HS-10	1	0.04	BR8HS1000000
V225, VX225, P200 (91~95)	BR9HS-10	1	0.04	BR9HS1000000
S250 / L250 (97~), SX250, LX250, VX250	BR9HS-10	1	0.04	BR9HS1000000
250/L250 (90~95) / S250 (96) B	BR8HS-10	1	0.04	BR8HS1000000
LZ250, Z250, Z300, LZ300	BKR6E-KU	Note 3	Note 3	BKR6EKU10000
V6 Excel	BR9HS-10	1	0.04	BR9HS1000000
V6 Spec	BR8HS-10	1	0.04	BR8HS1000000

Note 1: All NGK® spark plugs for Yamaha Outboards are sold in 10 packs. (Ordering 10 spark plugs will be equal to one box)

Note 2: Refer to Technical Bulletin O2000-015A to ensure the correct spark plug and gap are used.

Note 3: Refer to Technical Bulletin O2003-016 to ensure the correct spark plug and gap are used.

4-Stroke Oil Filters



3FV-13440-30-00

F25, F15 (1998-1999)
 F40 (1999-2000)
 T50 (1996-1999)
 F50 (1995-1999)
 F80, F100 (1999)



5GH-13440-60-00

F15C, F20
 F25 (04/2009 ~)
 F40A (2001~)
 F50 / T50 (2005~)
 F60 / T60 (2005~)
 F70



5GH-13440-70-00

F15 (20000~2005)
 F30, F40, F40B
 F50 / T50 (1999-2004)
 F60 / T60 (1999-2004)
 F75, F90, F115
 T25, F25 (2000-04/2006)
 T9.9 / F9.9 (2005 - 04/06)
 F80, F100 (2000~)
 F90
 VF90



69J-13440-03-00

F150
 VF150
 F200 (Inline)
 F200, F225 (V6)
 F250, F250B



N26-13440-02-00

F225C, F250C, F300 (4.2L)
 F300, F350 (V8)
 VF200, VF225, VF250 (4.2L)
 XTO® 425



6G8-13440-00-00

F9.9 (1990 - 04/05)
 T9.9 (1991 - 04/05)



Oil Drain Screw Gasket
 Used on most Yamaha
 4-Stroke Models.
90430-14M09-00



Oil Drain Screw
 Used on most Yamaha
 4-Stroke Models.
90340-14M06-00

Why Yamaha Oil Filters?

Customers come to your dealership for the service they trust. Why risk that on an aftermarket filtration element and cardboard filter ends? Yamaha oil filters are constructed with molded high quality media for long life and superior filtration.



2-Stroke Oil Strainers



6E5-13411-00-00

115, 130, 150, 175, 200
 B115, D150, DX150, PX150
 ProV150, V6 EXCEL
 P115, P150, P175, P200
 S115, S130, S150, S175,
 S200
 SX150, SX200
 V150, VX150, V175
 VZ150, VZ175, VZ200 (2.6L)
 Z150, Z175, Z200



6J8-13411-00-00

20, 25, 30 (89~)
 40, 50, 60, 70 (89~)
 C30 (89~)
 P40, P50, P60 (89~)
 Pro50



61A-13411-00-00

V200, V225
 VX200, VX225, VX250
 VZ200, VZ225 (3.3L)
 VZ250, VZ300 (3.3L)
 S225, SX225, S250, SX250
 250 (90~95)
 Z250, Z300



6H1-13411-00-00

90 (89~)
 C90, B90 (89~)



Electric Oil Pump Strainer

Used on all HPDI engines between the engine oil tank and the electric oil pump.

68F-13440-00-00



Remote Oil Tank Filter

Remote oil tank filters are regularly missed during yearly service. Replacing the filter during the service can help prevent issues later down the road.

646-24251-02-00

In Line Fuel Filters



646-24251-02-00

- 4 (97~99)
- F4 (99~06/2008)
- 5 (97~01)
- 6 (86~00)
- 8
- F9.9 (85~04/2005)
- T9.9 (91~04/2005)



60V-24251-01-00

- Z150, Z175
- Z200, Z225
- Z250, Z300
- VZ150, VZ175, VZ200
- VZ225, VZ250, VZ300



6C5-24251-00-00

- F40 (EFI)
- F50/F60 (05~)
- T50/T60 (05~)
- F70
- F75/F90 (05~)
- F90B
- VF90



68T-24251-01-00

- F4/F6 (09/2009~)
- F6 (01~04/2006)
- F8/T8 (01~)
- F9.9/T9.9G (04/2007~)



65W-24251-10-00

- F30 (05~)
- F40 (05~)



67F-24251-02-00

- F80
- F100



67F-14371-01-00

- F80 (Carb Inlet)
- F100 (Carb Inlet)



6L5-24251-00-00

- F2.5 (03~)
- 3 (92~02)
- F4 (99~06/2008)



6AW-24502-10-00

- F300 (V8)
- F350 (V8)



68V-24502-30-00

- F115 (04/2010~)



68V-24502-02-00

- F115 (~03/2010)

General Information

Rigging Estimate Guide (Diagrams)

Rigging Components

Electrical Components

Engine Accessories

Propellers

Maintenance Items

Oils & Lubes

Detailing & Trailer Supplies

Accessories & Apparel

Generators & Accessories



69J-24501-00-00

F150 (~05)

F200 V6 (~05)

F225 (~05)



69J-24502-00-00

F70 (05~)

F90 (05~)

F150 (05~)

F200, F225 V6 (05~)



69J-24501-10-00

F150 (04/2005~)

F200, F225 V6 (04/2005~)

F250, F250B

Primary Fuel Filters



61N-24563-10-00

9.9, 15, 20, 25, C25 (94~)

F9.9/T9.9 (05~04/2006)

F15, F20, F25, T25 (05~)

30, 40, 50, 70, 90 (94~)

C30, C40, C50, C55, C70 (94~)

P40, P50, P60, P75 (94~)

F40 (99)

E48, E60, E75

F50/T50 (95~04)

F60/T60 (04~04/2005)

C75, C80, C85, C90 (94~)

F75 (03~04), F90 (03~04)

F80, F100, B90, B115

115/130/150/175 (94~)

C115 (94~96)

P115, P150, P175, P200 (94~)

S115, S130, S150, S175, S200

D150, V150, V175

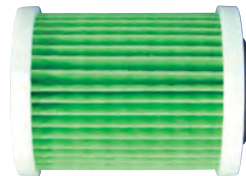

6P3-WS24A-01-00

VZ150, VZ175 (04/2006~)

Z200, Z300 (04/2006~)

VZ200, VZ225 (04/2006~)

VZ250, VZ300 (04/2006~)

F150, F200, F225 (04/2006~)

F250, F250B (04/2006~)

VF200, VF225, VF250 (4.2L)

F225C, F250C, F300C (4.2L)

F300, F350 (V8)

XTO® 425



6F5-24563-00-00

9.9, 15 (~93)

25, 30, 40, 50, 70, 90 (~93)

C25, C30, C40, C55, C85 (~93)

CV25, CV30

CV40, CV50, CV85

P50/P60 (~93)

PRO50

115/130/150/175 (~93)

200/225 (~93)

C115 (~93)

P115, P150, P200 (~93)

ProV150

V6Special, V6Excel

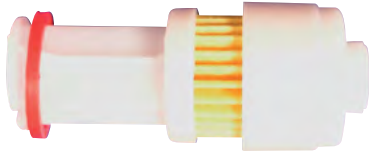

65L-24563-00-00

SX150, SX200, SX225,
SX250
VX150, DX150, PX150
F150, F200, F225 (~04/2005)
V200/V225
VX200, VX225, VX250
S225/S250 (97~99)

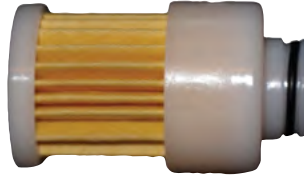

68V-24563-00-00

F50/T50 (05~04/2006)
F60/T60 (04/2005~)
F75/F90 (05~04/2006)
F115 (~04/2006)

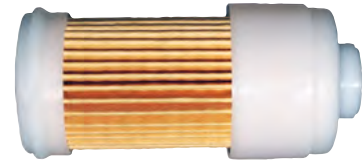

68F-24563-10-00

VZ150, VZ175 (05~04/2005)
VZ200 (05~04/2005)
Z150, Z175 (05~04/2005)
Z200, Z250 (05~04/2005)
VZ225, VZ250 (05~04/2005)
VZ300, Z300 (04~04/2005)

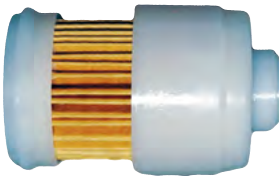

68F-24563-00-00

VZ150, VZ175, VZ200 (~04)
Z150, Z175, Z200, Z250 (~04)
VZ225, VZ250 (~04)

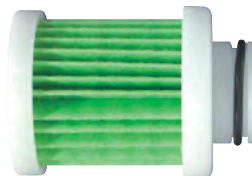

6D8-WS24A-00-00

F40A
F50/T50, F60/T60 (04/2006~)
F70
F75, F90, F115 (04/2006~)
F90B
VF90



61A-24563-00-00

S225, S250 (96)
C115, C150 (97~)

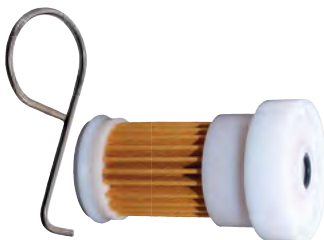

6P2-WS245-00-00

F250 (2005~04/05)

General Information

Rigging Estimate Guide (Diagrams)

Rigging Components

Electrical Components

Engine Accessories

Propellers

Maintenance Items

Oils & Lubes

Detailing & Trailer Supplies

Accessories & Apparel

Generators & Accessories

Remote Mounted Fuel Filters



10-Micron Fuel/Water Separating Filter

They are a primary line of defense against ethanol-related fuel system issues. Highly recommended for all two stroke and four stroke EFI outboards and two stroke HPDI's. Also excellent for carbureted engines. New, improved 10-micron filter provides superior filtration ahead of the engine's onboard filters and injectors. Large filtering and water capture areas maximize filtration while maintaining adequate flow rate for larger engines.

Assemblies

Assembly Stainless Steel Head **MAR-10MAS-10-00**

Assembly Stainless Steel Head 3/8" Fittings **MAR-10MAS-20-00**

Assembly Aluminum Head **MAR-10MAS-00-00**

Elements

Spin-On Filter Only **MAR-10MEL-00-00**

Bulk pack of 12 **MAR-10MEL-00-BK**

Filter Heads

Aluminum Filter Head 12 Pack **MAR-FLTHD-00-BK**

Stainless Steel Filter Head 12 Pack **MAR-FLTHD-10-BK**

Stainless Steel Filter Head 3/8" Fittings 12 Pack
MAR-FLTHD-20-BK

mini-10™

Assembly Aluminum Head **MAR-M10AS-00-00**

Spin-On Filter only **MAR-M10EL-00-00**

Brass Plugs

1/4" Brass Plug (fits all except 3/8") **MAR-BRASP-LG-14**

3/8" Brass Plug **MAR-BRASP-LG-38**

Yamaha Remote Filter

Assembly includes aluminum mounting head, spin-on element, metal bowl, and water sensor probe. Requires Yamaha Multifunction Fuel Management Gauge for water detection indication.



Elements

60 GPH **MAR-24563-00-00**

90 GPH **MAR-10171-20-00**

Filter Bowls

Clear Bowl without water probe **MAR-REPLB-OW-L1***

Clear bowl with water probe **MAR-REPLB-OW-L2***

Replacement Water Probe **MAR-10171-30-00**

* For above deck use only

Vapor Separator Tank (VST) Fuel Filters



66K-13915-00-00

SX150, SX200, SX225, SX250

DX150, PX150

VX150, VX200, VX225, VX250

S225, S250, V200, V225 (99-)



6CB-24501-00-00

VF200, VF225, VF250 (4.2L)

F225, F250, F300 (4.2L)



6BG-13915-01-00

F40 EFI

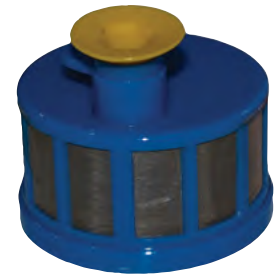

65L-13915-00-00

S225, S250 (97-98)

V200, V225 (97-98)



68F-13915-00-00

Z150, Z175, Z200

VZ150, VZ175, VZ200

VZ225, VZ250, VZ300

Z250, Z300



68V-13915-00-00

F115

F200, F225 (V6)



6C5-13915-00-00

F50/T50, F60/T60

F70, F75, F90



6FP-13915-00-00

F75B (17)

F90B

VF90



6CB-13915-00-00

VF200, VF225, VF250 (4.2L)

F225, F250, F300 (4.2L)



63P-13915-00-00

F150

F225 Sport, F250, F250B

F300, F350 (V8)

VST Gaskets

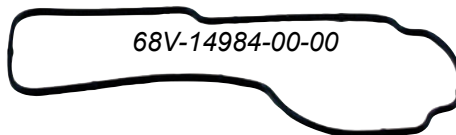
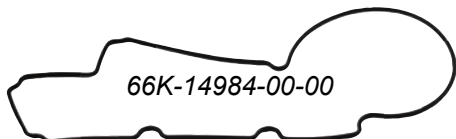
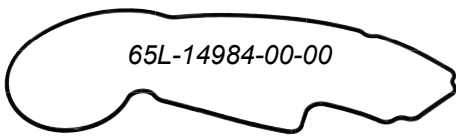
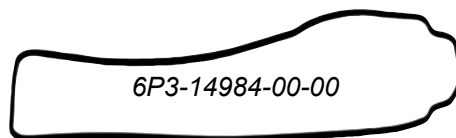
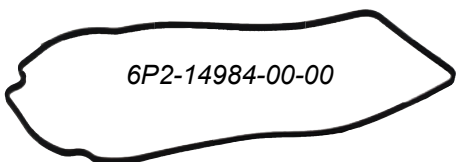
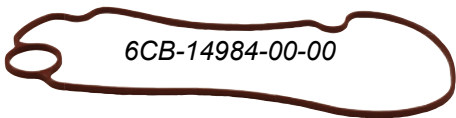
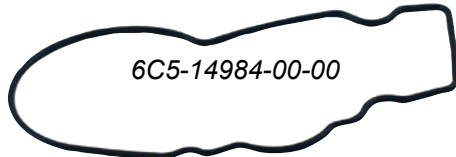
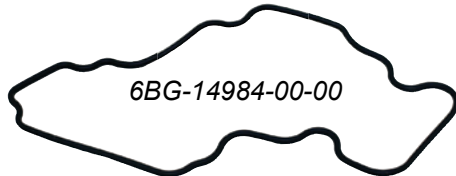
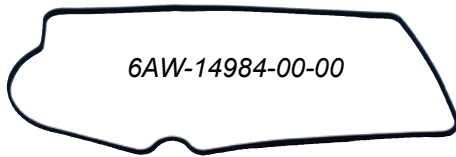

Application	Part Number
F40 EFI	6BG-14984-00-00
F50/T50, F60/T60	6C5-14984-00-00
F70	6C5-14984-00-00
F75, F90	6C5-14984-00-00
F115	68V-14984-00-00
F90B	6FP-14984-00-00
VF90	6FP-14984-00-00
F150	63P-14984-00-00
SX150, SX200, SX225, SX250	66K-14984-00-00
DX150, PX150	66K-14984-00-00
VX150, VX200, VX225, VX250	66K-14984-00-00
Z150, Z175, Z200, Z250, Z300	66K-14984-00-00
VZ150, VZ175, VZ200	66K-14984-00-00
F175	6CB-14984-00-00
V200, V225 (97~98)	65L-14984-00-00
V200, V25 (99~)	66K-14984-00-00
F200, F225 (V6)	68V-14984-00-00
VZ225, VZ250, VZ300	66K-14984-00-00
VF200, VF225, VF250 (4.2L)	6CB-14984-00-00
F225, F250, F300 (4.2L)	6CB-14984-00-00
S225, S250 (97~98)	65L-14984-00-00
S225, S250 (99~)	66K-14984-00-00
F225 Sport	6P2-14984-00-00
F250, F250B	6P2-14984-00-00
F300, F350 (V8)	6AW-14984-00-00
XTO® 425	6GR-24218-00-00

Engine Timing Belts

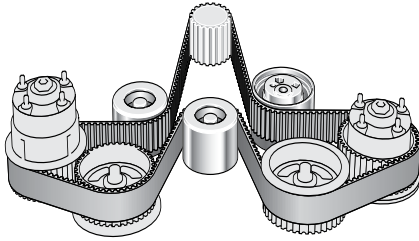

Application	Part Number
F6 (05~06/2008)	68T-46241-00-00
F6, F8, T8 (01~04)	68T-46241-00-00
F8, T8 (05~)	68T-46241-00-00
F9.9, FT9.9 (85~04/2005)	6G8-46241-00-00
T9.9 (91~04/2005)	6G8-46241-00-00
F9.9-2, T9.9-2 (05~04/2006)	66M-46241-00-00
F9.9F, T9.9F (04/2007~)	68T-46241-00-00
F15 (98~04/2005)	66M-46241-00-00
F15C, F20	6AH-46241-00-00
F25, T25 (98~04/2006)	65W-46241-00-00
F25, T25 (04/2009~)	6C5-46241-00-00
F30	65W-46241-00-00
F40 (99)	62Y-46241-00-00
F40 (00~04/2008)	65W-46241-00-00
F40LA	6C5-46241-00-00
F50, T60 (96~04)	62Y-46241-00-00
F60, T60 (02~04)	62Y-46241-00-00
F50, T50, F60, T60, F70 (05~)	6C5-46241-00-00
F75, F90	67F-46241-00-00
F90B	6FP-W4624-00-00
VF90	6FP-W4624-00-00
F80, F100	67F-46241-00-00
F115	67F-46241-00-00
F115	6EK-W4624-00-00
F150	63P-46241-00-00
F200, F225	69J-46241-00-00
VF200, VF225, VF250 (4.2L)	6CB-W4624-00-00
F225, F250, F300 (4.2L)	6CB-W4624-00-00
F225 Sport, F250, F250B	6P2-46241-02-00
F300, F350 (V8)	6AW-W4624-00-00
2.6L HPDI (04~)	68F-46241-10-00
2.6L HPDI (~03)	68F-46241-00-00
3.3L HPDI	60V-46241-00-00
XTO® 425	6GR-W4624-00-00

General Information

Rigging Estimate Guide (Diagrams)

Rigging Components

Electrical Components

Engine Accessories

Propellers

Maintenance Items

Oils & Lubes

Detailing & Trailer Supplies

Accessories & Apparel

Generators & Accessories

Trim Tabs

2-Stroke Application	Part Number
20, 25, C25, 30, 40, 50	664-45371-01-00
CV25, CV30, C40 (97~), C50	664-45371-01-00
C40 (~96), CV40, E48, C55, CV55	679-45371-00-00
P40, P50, PRO 50	664-45371-01-00
60, 70, 90, E60, P60, E75, P75, B90	67F-45371-00-00
C60, C70, C75, C80, C85, CV85, C90	67F-45371-00-00
60~130 High Performance Propeller	6E5-45371-01-00
C150 (96~99), 150, 175, S175, V175	6J9-45371-01-00
P150, PX150, ProV150, P175	6J9-45371-01-00
S150, SX150, V150, VX150	6J9-45371-01-00
Z150, Z175, Z200 (2.6L)	6J9-45371-01-00
200, P200, S200, SX200	6J9-45371-01-00
VZ200, VZ225, VZ250, VZ300 (3.3L)	69L-45371-00-00
225, S225, SX225, 250, S250, SX250	61A-45371-00-00
V200, VX200, V225, VX225	61A-45371-00-00
Z250, Z300	69L-45371-00-00
L130 (~01)	6L6-45371-00-00
L225, LX225, L250, LX250 (92~03)	61A-45371-00-00
L150, LX150, L200, LX200 (~01)	6K1-45371-02-00
LZ150, LZ200	6K1-45371-02-00

4-Stroke Application	Part Number
F9.9G, F15	66M-45371-00-00
F15C, F20	6AH-45371-A0-8D
F25 (98~)	61N-45371-00-00
T25, F30, F40 (00~)	67C-45371-00-00
F40, F50 (95~00)	664-45371-01-00
F50, F60 (01~)	67C-45371-00-00
T50 (96~00)	67F-45371-00-00
T50 (96~97)	664-45371-01-00
T50, T60 (01~)	67F-45371-00-00
F70, F75, F80, F90, F100	67F-45371-00-00
F90B, VF90, F115	6E5-45371-01-00
F150	6J9-45371-01-00
F200, F225, F225 Sport, F250, F250B	61A-45371-00-00
VF200, VF225, VF250	6AW-45619-00-00
F225, F250, F300 (4.2L)	61A-45371-00-00
F300, F350 (V8)	6AW-45619-00-00
LF115	6L6-45371-00-00
LF150	6K1-45371-00-00
Stern drives	6T5-45371-00-00

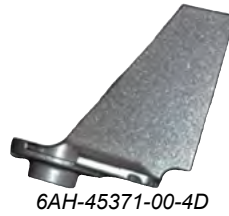

6AH-45371-00-4D



66M-45371-00-00



61N-45371-00-00

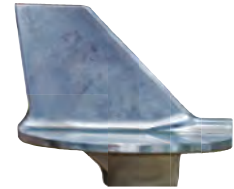

6L6-45371-00-00



679-45371-00-00



67C-45371-00-00



67F-45371-00-00



6K1-45371-02-00



6E5-45371-01-00



6AW-45619-00-00



69L-45371-00-00



6E5-45371-10-00



664-45371-01-00



61A-45371-00-00



67F-45371-00-00



6J9-45371-02-00

Anodes

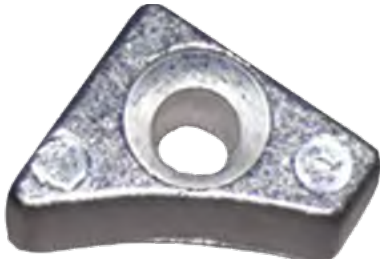

2-Stroke Application	Part Number
6 (90~93)	6GH-45251-00-00
9.9, 15 (95~02)	61N-45251-01-00
C30 (93~97)	61N-45251-01-00
40, C40, 50	63D-45251-01-00
40, C40, 50 (01~)	65W-45251-00-00
C40 (91~97)	676-45251-00-00
CV40	676-45251-00-00
C55 (91~95)	663-45251-00-00
CV55 (88~89)	663-45251-00-00
50 (00)	663-45251-00-00
C55, C60, C70, C75, C80, C85, C90	6H1-45251-03-00
60, 70, 90 (00~)	6H1-45251-03-00
E60, E75	6H1-45251-03-00
2 Stroke V4 & V6 ALL	6G5-45251-02-00

4-Stroke Application	Part Number
F6 (04/05~06/08)	68T-45251-00-00
T8 (01~)	65W-45251-00-00
F9.9 (98~)	6E8-45251-02-00
T9.9G	65W-45251-00-00
F15 (01~)	65W-45251-00-00
F15C, F20	65W-45251-00-00
F25, T25 (99~)	65W-45251-00-00
F30, F40 (00~)	65W-45251-00-00
F50, T50, F60, T60 (01~)	65W-45251-00-00
F70	65W-45251-00-00
F75, F80, F90, VF90, F100	6H1-45251-03-00
F115, F150, F200, F225	6G5-45251-02-00
VF200, VF225, VF250	65W-45251-00-00
F225 Sport, F250, F250B	6G5-45251-02-00
F225, F250, F300 (4.2L)	6G5-45251-02-00
F300, F350 (V8)	6AW-45251-00-00
XTO® 425	6AW-45373-00-00

General Information

Rigging Estimate Guide (Diagrams)

Rigging Components

Electrical Components

Engine Accessories

Propellers

Maintenance Items

Oils & Lubes

Detailing & Trailer Supplies

Accessories & Apparel

Generators & Accessories

Thermostats



2-Stroke Application	Part Number
3, 4, 5, 6, 8	6E5-12411-02-00
9.9, 15 (~95)	6F5-12411-03-00
9.9, 15 (96~)	6E5-12411-30-00
20, 40, 50, C50, P50	6E5-12411-30-00
25 Three Cylinder	6E5-12411-30-00
25 Two Cylinder	6E5-12411-30-00
C25	6F5-12411-03-00
30 (~91)	6E5-12411-30-00
30 (92~)	6E5-12411-30-00
C30 (~92)	6F5-12411-03-00
C30 (93~)	6E5-12411-02-00
40, 50	6E5-12411-30-00
C40, C55 (~97)	6F5-12411-03-00
C40 (98~)	6E5-12411-30-00
60, C60, E60, P60, 70, C70	6H3-12411-11-00
C75, P75, E75, C80, C85, 90, C90	6E5-12411-30-00
115,130, 150, 175, 200, 225, 250	6E5-12411-30-00
B115, C115, C150, D150, DX150	6E5-12411-30-00
P115, P150, PX150, P200	6E5-12411-30-00
S115, S130, SX150, SX200	6E5-12411-30-00
S225, SX225, S250, SX250	6E5-12411-30-00
V150, VX150, V200, VX200	6E5-12411-30-00
VX225, VX250	6E5-12411-30-00
VZ150, VZ175, VZ200 (2.6L)	6E5-12411-30-00
Z150, Z175, Z200 (2.6L)	6E5-12411-30-00
VZ200, VZ225, VZ250, VZ300 (3.3L)	60V-12411-00-00
Z250, Z300 (3.3L)	60V-12411-00-00

4-Stroke Application	Part Number
F2.5, F4, F4A, F6, F6A, F8, T8	66M-12411-01-00
F9.9, T9.9, F15, F25, T25	66M-12411-01-00
F15C-F20	6AH-12411-00-00
F30, F40, F40A, F50, T50	66M-12411-01-00
F60, T60, F70	66M-12411-01-00
F75, F90	67F-12411-01-00
F90B	6FP-12411-00-00
VF90	6FP-12411-00-00
F80, F100 (~00)	66M-12411-01-00
F80, F100 (01~)	67F-12411-01-00
F115	60V-12411-00-00
F115B	6EK-12411-00-00
F150, F200, F225, F250, F250B	6CB-12411-10-11
VF200, VF225, VF250 (4.2L)	67F-12411-01-00
F225, F250, F300 (4.2L)	6CE-12411-00-00
F300, F350 (V8)	6AW-12411-00-00
XTO® 425	6GR-12411-00-00

Thermostat Gaskets



Application	Part Number
F2.5 (03~)	67D-12414-A0-00
F4 (99~)	67D-12414-A0-00
F4A, F6A	67D-12414-A0-00
F6, F8, T8, F9.9, FT9.9, T9.9	6G8-12414-A0-00
9.9, 15	682-12414-A1-00
F9.9-2, T9.9-2	62Y-12414-00-00
F15, F25, T25, F30	62Y-12414-00-00
F15C, F20	6AH-12414-00-00
20	61A-12414-A0-00
25, 30, 40	61A-12414-A0-00
C25, CV25, C30, CV30	655-12414-A1-00
C40, CV40 (~97)	6E9-12414-A1-00
C40, C50 (98~)	61A-12414-A0-00
P40	61A-12414-A0-00
F40, F50, T50, F60, T60, F70	62Y-12414-00-00
C55, E48	663-12414-A0-00
C75, E75, P75, C80, C80	688-12414-A1-00
C85, CV85, C90	688-12414-A1-00
90, B90, B115	688-12414-A1-00
115, 130, 150, 175, 200	688-12414-A1-00
P115, P150, PX150, P175, P200	688-12414-A1-00
S115, S130, S150, S175, S200	688-12414-A1-00
D150, DX150	688-12414-A1-00
F150	63P-12414-00-00
SX150, SX200, V150, VX150, V175	688-12414-A1-00
ProV150	688-12414-A1-00
VZ150, VZ175, VZ200 (2.6L)	688-12414-A1-00
Z150, Z175, Z200 (2.6L)	688-12414-A1-00
V200, V225	61A-12414-A0-00
VX200, VX225, VX250	61A-12414-A0-00
VZ200, VZ225, VZ250, VZ300 (3.3L)	60V-12414-A0-00
Z250, Z300	60V-12414-A0-00
225 (2.6L)	688-12414-A1-00
225, 250, S225, S250, SX225, SX250	61A-12414-A0-00

General Information

Rigging Estimate Guide (Diagrams)

Rigging Components

Electrical Components

Engine Accessories

Propellers

Maintenance Items

Oils & Lubes

Detailing & Trailer Supplies

Accessories & Apparel

Generators & Accessories

4-Stroke Carburetor Repair Kits

F2.5 - 69M-W0093-00-00

Kit Includes:

Qty	Description	Part #
1	Gasket, Float Chamber	69M-14984-00-00
1	Float	69M-14385-00-00
1	Pin, Float	6A1-14386-00-00
1	Screw, Pan Head	98580-03006-00
1	Valve, Needle	62Y-14392-00-00
1	Screw	69M-14991-00-00
2	Screw, Pan Head	98580-04010-00
1	O-Ring	2T4-14397-00-00
1	Gasket	69M-14536-00-00
1	Valve	69M-24523-00-00
1	O-Ring	69M-24533-00-00
1	Screw, Lever Fitting	69M-24535-00-00

F4 (03~06/2008) - 67D-W0093-01-00

Kit Includes:

Qty	Description	Part #
1	Float	68T-14385-00-00
1	Pin, Float	67D-14386-00-00
1	Valve, Needle	67D-14546-00-00
1	Gasket, Float Chamber	67D-14984-00-00
1	Gasket	6J8-14995-00-00
2	Screw, With Washer	97980-04112-00
1	Gasket	67D-14536-00-00

F4 (~-02) - 67D-W0093-00-00

Kit Includes:

Qty	Description	Part #
1	Float	67D-14385-00-00
1	Pin, Float	67D-14386-00-00
1	Valve, Needle	67D-14546-00-00
1	Gasket, Float	67D-14984-00-00
1	Gasket	6J8-14995-00-00
2	Screw, With Washer	97980-04112-00
1	Gasket	67D-14536-00-00

F4, F6 (09/2009~) - 6BX-W0093-00-00

Kit Includes:

Qty	Description	Part #
1	Float	6BX-14985-00-00
1	Gasket, Float Chamber	6BX-14984-00-00
2	Screw	6BX-14592-00-00
2	O-Ring	4JH-14562-00-00
1	Valve, Needle	6BX-14546-00-00
1	Pin, Float Arm	6BX-14548-00-00
1	Clip	6BX-14937-00-00

F6 (04/2007~06/2008) F8, T8, F9.9, T9.9 (04/2007~) 6AU-W0093-00-00

Kit Includes:

Qty	Description	Part #
2	Screw, With Washer	97980-04112-00
1	Float	6AU-14385-00-00
1	Pin, Float	67D-14386-00-00
1	Valve, Needle	68T-14546-00-00
1	Gasket, Float Chamber	6AU-14984-00-00
1	Gasket	6J8-14995-00-00
1	Gasket	67D-14536-00-00

F6, F8, T8 (~04/2006) - 68T-W0093-00-00

Kit Includes:

Qty	Description	Part #
1	Float	68T-14385-00-00
1	Pin, Float	67D-14386-00-00
1	Valve, Needle	68T-14546-00-00
1	Gasket, Float Chamber	67D-14984-00-00
1	Gasket	6J8-14995-00-00
2	Screw, With Washer	97980-04112-00
1	Gasket	67D-14536-00-00

FT9.9 - 6G8-W0093-02-00

Kit Includes:

Qty	Description	Part #
1	Gasket	6G8-14198-A0-00
1	Gasket, Float Chamber	6G8-14384-00-00
1	Pin, Float	647-14386-10-00
1	Gasket	654-14198-00-00
1	Screw, Air Adjusting	6G8-14323-00-00
1	Valve, Needle	6G8-14392-00-00
1	Float	6G8-14385-00-00
1	Screw, Panhead	98580-04016-00
1	Washer, Spring	92990-04100-00
2	O-Ring	1J2-14397-00-00
1	O-Ring	5H0-14397-00-00
1	O-Ring	5Y1-14397-00-00

F9.9-2, T9.9-2, F15 (~04/2005)

66M-W0093-01-00

Kit Includes:

Qty	Description	Part #
1	Gasket	66M-14398-00-00
1	Gasket	6L2-14398-00-00
1	Stopper	66M-14377-00-00
1	Gasket, Float Chamber	66M-14384-00-00
1	Float	6L2-14385-00-00
1	Pin, Float	6E5-14386-01-00
1	Valve, Needle	6L2-14392-00-00
1	Gasket	62Y-14399-00-00
1	Screw, Air Adjusting	12V-14105-00-00
4	Screw, With Washer	97980-04112-00
1	O-Ring	5H0-14397-00-00
1	O-Ring	6F5-14397-00-00
1	Filter	66M-14827-00-00

F9.9, T9.9 (~04/2005) - 6G8-W0093-03-00

Kit Includes:

Qty	Description	Part #
1	Gasket	6G8-14198-A0-00
1	Gasket, Float Chamber	6G8-14384-01-00
1	Pin, Float	647-14386-10-00
1	Gasket	654-14198-00-00
1	Screw, Air Adjusting	6G8-14323-00-00
1	Valve, Needle	6G8-14392-00-00
1	Float	6G8-14385-00-00
1	Screw, Panhead (+)	98580-04016-00
1	Washer, Spring	92990-04100-00
1	O-Ring	5Y1-14397-00-00

F15C, F20 (04/2006~04/2009)

6AH-W0093-00-00

Kit Includes:

Qty	Description	Part #
1	Gasket	65W-14126-10-00
1	Valve, Needle	6G1-14546-01-00
1	Pin, Float	676-14186-00-00
1	Pin, Float Arm	6H4-14548-00-00
1	Cover, Plunger Cap	65W-14373-01-00
1	O-Ring	67F-14398-10-00
1	Gasket, Float Chamber	6AH-14384-00-00
1	Gasket	6G1-14398-00-00
4	Screw, With Washer	97980-04114-00
1	Float	6AH-14985-00-00
1	Clip	633-14159-00-00

F15C, F20 (04/2010~) - 6AH-W0093-01-00

Kit Includes:

Qty	Description	Part #
1	Gasket	65W-14126-10-00
1	Valve, Needle	6AH-14546-00-00
1	Pin, Float Arm	6H4-14548-00-00
1	Cover, Plunger Cap	65W-14373-02-00
1	O-Ring	67F-14398-10-00
1	Gasket, Float Chamber	6AH-14384-00-00
1	Gasket	6G1-14398-00-00
4	Screw, With Washer	97980-04114-00
1	Float	6AH-14985-00-00
1	Clip	633-14159-00-00

General Information

Rigging Estimate Guide (Diagrams)

Rigging Components

Electrical Components

Engine Accessories

Propellers

Maintenance Items

Oils & Lubes

Detailing & Trailer Supplies

Accessories & Apparel

Generators & Accessories

Maintenance Items

General Information

Rigging Estimate Guide (Diagrams)

Rigging Components

Electrical Components

Engine Accessories

Propellers

Maintenance Items

Oils & Lubes

Detailing & Trailer Supplies

Accessories & Apparel

Generators & Accessories

F25, T25 (~03) - 65W-W0093-00-00

Kit Includes:

Qty	Description	Part #
1	Gasket	65W-14126-00-00
1	Valve, Needle	6G1-14546-01-00
1	Pin, Float	676-14186-00-00
1	Pin, Float Arm	6H4-14548-00-00
1	Cover, Plunger Cap	65W-14373-01-00
1	O-Ring	65W-14147-00-00
1	Spring, Plunger	65W-14335-00-00
1	Gasket, Float Chamber	65W-14384-00-00
1	Gasket	6G1-14398-00-00
4	Screw, With Washer	97980-04114-00
1	Float	63V-14985-00-00
1	Clip	633-14159-00-00

F25, T25 (04/2009~) - 6BL-W0093-00-00

Kit Includes:

Qty	Description	Part #
1	Gasket	65W-14126-10-00
1	Valve, Needle	6AH-14546-00-00
1	Pin, Float Arm	6H4-14548-00-00
1	Cover, Plunger Cap	65W-14373-02-00
1	O-Ring	67F-14398-10-00
1	Spring, Plunger	65W-14335-00-00
1	Gasket, Float Chamber	65W-14384-00-00
1	Gasket	6G1-14398-00-00
4	Screw, With Washer	97980-04114-00
1	Float	63V-14985-00-00
1	Clip	633-14159-00-00

F25, T25 (04~04/2006), F30, F40, F40B (00~) - 65W-W0093-02-00

Kit Includes:

Qty	Description	Part #
1	Gasket	65W-14126-10-00
1	Valve, Needle	6G1-14546-01-00
1	Pin, Float	676-14186-00-00
1	Pin, Float Arm	6H4-14548-00-00
1	Cover, Plunger Cap	65W-14373-02-00
1	O-Ring	67C-14398-10-00
1	Spring, Plunger	65W-14335-00-00
1	Gasket, Float Chamber	65W-14384-00-00
1	Gasket	6G1-14398-00-00
4	Screw, With Washer	97980-04114-00
1	Float	63V-14985-00-00
1	Clip	633-14159-00-00

F40 (99), F50 (~00) - 62Y-W0093-00-00

Kit Includes:

Qty	Description	Part #
1	Gasket, Float Chamber	6L2-14384-00-00
1	Float	6L2-14385-00-00
1	Pin, Float	6E5-14386-01-00
1	Valve, Needle	6L2-14392-00-00
1	Gasket	62Y-14399-00-00
1	Plug	62Y-14355-00-00
1	Screw, Air Adjusting	12V-14105-00-00
4	Screw, With Washer	97980-04112-00
1	O-Ring	5H0-14397-00-00
1	Gasket	62Y-14398-00-00
1	O-Ring	6F5-14397-00-00
4	O-Ring	93210-30MH4-00
4	O-Ring	93210-35M86-00

F50 (01~) - 62Y-W0093-11-00

Kit Includes:

Qty	Description	Part #
1	Gasket, Float Chamber	62Y-14384-30-00
1	Float	6L2-14385-00-00
1	Pin, Float	6E5-14386-01-00
1	Valve, Needle	6L2-14392-00-00
8	Screw, Throttle	62Y-14321-00-00
1	Gasket	62Y-14399-30-00
1	Plug	62Y-14355-30-00
1	Screw, Air Adjusting	62Y-14323-30-00
1	O-Ring	2T4-14397-00-00
1	O-Ring	652-14397-00-00
1	Gasket	62Y-14398-30-00
4	O-Ring	93210-30MH4-00
4	O-Ring	93210-35M86-00
1	Washer	62Y-14227-00-00

F60 - 69W-W0093-10-00

Kit Includes:

Qty	Description	Part #
1	Gasket, Float Chamber	69W-14384-00-00
1	Float	6L2-14385-00-00
1	Pin, Float	6E5-14386-01-00
1	Valve, Needle	6L2-14392-00-00
8	Screw, Throttle	62Y-14321-00-00
1	Gasket	69W-14399-00-00
1	Screw, Air Adjusting	69W-14323-00-00
1	O-Ring	2T4-14397-00-00
1	O-Ring	652-14397-00-00
1	Gasket	62Y-14398-30-00
4	O-Ring	69W-14561-00-00
4	O-Ring	93210-35M86-00
4	O-Ring	93210-38MH3-00
4	Washer	62Y-14227-00-00

F75, F90, F80/F100 (03~) - 67F-W0093-02-00

Kit Includes:

Qty	Description	Part #
1	O-Ring	67F-14147-00-00
4	Screw, With Washer	97980-04114-00
1	O-Ring	67F-14397-00-00
1	Gasket, Float Chamber	67F-14984-00-00
1	O-Ring	93210-04230-00
1	Float	6H4-14985-01-00
1	Pin, Float	676-14186-00-00
1	Clip	67F-14159-00-00
1	Pin, Float Arm	6H4-14548-00-00
1	Needle Valve Assy	60C-14590-02-00
1	O-Ring	93210-04228-00
1	O-Ring	67F-14398-00-00
1	O-Ring	67F-14398-10-00
1	O-Ring	67F-14398-20-00
1	Seal	67F-14239-00-00
1	Element, Filter	67F-14371-01-00
2	O-Ring	93210-40M10-00
1	O-Ring	67F-14398-30-00

F80, F100 (~02) - 67F-W0093-00-00

Kit Includes:

Qty	Description	Part #
1	O-Ring	67F-14147-00-00
4	Screw, With Washer	97980-04114-00
1	O-Ring	67F-14397-00-00
1	Gasket, Float Chamber	67F-14984-00-00
1	O-Ring	93210-04230-00
1	Float	6H4-14985-01-00
1	Pin, Float	676-14186-00-00
1	Clip	633-14159-00-00
1	Pin, Float Arm	6H4-14548-00-00
1	Needle Valve Assy	6H3-14590-01-00
1	O-Ring	93210-04228-00
1	O-Ring	67F-14398-00-00
2	O-Ring	67F-14398-10-00
1	O-Ring	67F-14398-20-00
1	Seal	67F-14239-00-00
1	Element, Filter	67F-14371-01-00
2	O-Ring	93210-40M10-00
1	O-Ring	67F-14398-30-00

General Information

Rigging Estimate Guide (Diagrams)

Rigging Components

Electrical Components

Engine Accessories

Propellers

Maintenance Items

Oils & Lubes

Detailing & Trailer Supplies

Accessories & Apparel

Generators & Accessories

2-Stroke Carburetor Repair Kits

2 (90~93)

Part List (not sold as a kit):

Qty	Description	Part #
1	Gasket, Float Chamber	6A1-14384-00-00
1	Float	6A1-14385-00-00
1	Pin, Float	6A1-14386-00-00
2	Screw, Panhead	98580-04010-00
1	Valve, Needle	6A1-14392-00-00
1	Screw, Pilot Adjusting	646-14211-02-00
1	Needle	6A1-14116-10-00
1	Clip	646-14137-00-00
1	Cap	646-14169-00-00
1	O-Ring	646-14229-01-00
1	Gasket	6A1-14398-00-00

2 (94~) - 6A1-W0093-03-00

Kit Includes:

Qty	Description	Part #
1	Gasket, Float Chamber	6A1-14384-00-00
1	Float	6A1-14385-00-00
1	Pin, Float	6A1-14386-00-00
2	Screw, With Washer	97980-04110-00
1	Valve, Needle	6A1-14392-00-00
1	Screw, Pilot Adjusting	646-14211-02-00
1	Needle	6A1-14116-10-00
1	Clip	646-14137-00-00
1	Cap	646-14169-00-00
1	O-Ring	646-14229-01-00
1	Gasket	646-14198-01-00

3, 6, 8 (90~96) - 6G1-W0093-00-00

Kit Includes:

Qty	Description	Part #
1	Screw, Pilot	679-14923-00-00
1	Cap	6G1-14966-00-00
1	Gasket	6G1-14126-00-00
1	Cap	679-14966-00-00
1	O-Ring	6G1-14984-00-00
4	Screw, With Washer	97980-04114-00
1	Float	6G1-14985-00-00
1	Valve, Needle	6G1-14546-01-00
1	Pin, Float	676-14186-00-00
1	Pin, Float Arm	688-14548-00-00

4 (90~94) - 6E0-W0093-02-00

Kit Includes:

Qty	Description	Part #
1	Gasket	6E0-14198-A0-00
1	Gasket, Float Chamber	6E0-14384-00-00
1	Screw, Panhead	98580-04016-00
1	Gasket	6A1-14398-00-00
1	Float	6E7-14385-00-00
1	Pin, Float	647-14386-10-00
1	Valve, Needle	6G8-14392-10-00
1	Gasket	6E0-14227-00-00
1	Screw, Air Adjusting	647-14323-00-00
1	Diaphragm	6E0-24471-00-00
1	Diaphragm	6E0-24411-00-00

4, 5 (95~96) - 6E0-W0093-03-00

Kit Includes:

Qty	Description	Part #
1	Gasket	6E0-14198-A0-00
1	Gasket, Float Chamber	6E0-14384-00-00
1	Screw, Panhead	98580-04016-00
1	Gasket	6A1-14398-00-00
1	Float	6E7-14385-01-00
1	Pin, Float	647-14386-10-00
1	Valve, Needle	6F5-14392-00-00
1	Gasket	6E0-14227-00-00
1	Screw, Air Adjusting	647-14323-00-00
1	Diaphragm	6E0-24471-00-00
1	Diaphragm	6E0-24411-00-00

4 (97~) - 6E0-W0093-04-00

Kit Includes:

Qty	Description	Part #
1	Gasket	6E0-14198-A0-00
1	Gasket, Float Chamber	6E0-14384-00-00
4	Screw, With Washer	98580-04016-00
1	Gasket	646-14198-01-00
1	Float	6E7-14385-01-00
1	Pin, Float	647-14386-10-00
1	Valve, Needle	6F5-14392-00-00
1	Gasket	6E0-14227-00-00
1	Screw, Air Adjusting	647-14323-00-00
1	Diaphragm	6E0-24471-00-00
1	Diaphragm	6E0-24411-00-00

6, 8 (97~) - 6G1-W0093-00-00

Kit Includes:

Qty	Description	Part #
1	ScREW, Pilot	679-14923-00-00
1	Cap	6G1-14966-00-00
1	Gasket	6G1-14126-00-00
1	Cap	679-14966-00-00
1	O-Ring	6G1-14984-00-00
4	Screw, With Washer	97980-04114-00
1	Float	6G1-14985-00-00
1	Valve, Needle	6G1-14546-01-00
1	Pin, Float	676-14186-00-00
1	Pin, Float Arm	688-14548-00-00

15 (93~95)

Part List (not sold as a kit):

Qty	Description	Part #
1	Needle Valve Assy	61J-14390-00-00
1	Gasket	367-14195-00-00
1	Float	6E7-14385-00-00
1	Pin, Float	647-14386-10-00
1	Gasket, Float Chamber	677-14384-01-00
1	Gasket	1J2-14398-00-00
1	Gasket	655-14398-00-00
1	Screw, Air Adjusting	647-14323-00-00
1	Gasket	6E7-14227-00-00

20, 25 Two Cyl - 6L2-W0093-00-00

Kit Includes:

Qty	Description	Part #
2	Gasket	6L2-14198-00-00
2	Gasket, Float Chamber	6L2-14384-00-00
2	Float	6L2-14385-00-00
2	Pin, Float	6E5-14386-01-00
2	Valve, Needle	6L2-14392-00-00
2	Gasket	6L2-14399-00-00
2	Screw, With Washer	97980-04112-00
2	Gasket	6L2-14398-00-00

9.9 (90~95), 15 (90~92) - 6E7-W0093-04-00

Kit Includes:

Qty	Description	Part #
1	Gasket	677-14198-A1-00
1	Needle Valve Assy	6E8-14390-12-00
1	Gasket	367-14195-00-00
1	Float	6E7-14385-00-00
1	Pin, Float	647-14386-10-00
1	Gasket, Float Chamber	677-14384-01-00
1	Gasket	1J2-14398-00-00
1	Gasket	655-14398-00-00
1	Screw, Air Adjusting	647-14323-00-00
1	Gasket	6E7-14227-00-00

9.9, 15 (96~) - 63V-W0093-01-00

Kit Includes:

Qty	Description	Part #
1	Screw, Pilot	679-14923-00-00
1	Gasket	63V-14126-00-00
1	Gasket, Float Chamber	63V-14984-00-00
4	Screw, With Washer	97980-04114-00
1	Gasket	6G1-14398-00-00
1	Float	63V-14985-00-00
1	Valve, Needle	6G1-14546-01-00
1	Pin, Float	676-14186-00-00
1	Clip	633-14159-00-00
1	Pin, Float Arm	6H4-14548-00-00

25 (84~87), C25 (91~97), CV25 (90), 30 (84~86), C30 (91~92), CV30 (89~90) - 689-W0093-02-00

Kit Includes:

Qty	Description	Part #
1	Gasket	648-14198-A0-00
1	Gasket, Float Chamber	648-14384-01-00
1	Float	648-14385-00-00
4	Screw, With Washer	98517-04012-00
1	Washer, Spring	92990-04100-00
1	Needle Valve Assy	61K-14390-00-00
1	Screw, Air Adjusting	647-14323-00-00
2	Bush	90386-05002-00
1	O-Ring	646-14397-00-00

General Information

Rigging Estimate Guide (Diagrams)

Rigging Components

Electrical Components

Engine Accessories

Propellers

Maintenance Items

Oils & Lubes

Detailing & Trailer Supplies

Accessories & Apparel

Generators & Accessories

Maintenance Items

General Information

Rigging Estimate Guide (Diagrams)

Rigging Components

Electrical Components

Engine Accessories

Propellers

Maintenance Items

Oils & Lubes

Detailing & Trailer Supplies

Accessories & Apparel

Generators & Accessories

25 Three cyl (97~02), 30, C30 Three cyl (95) - 6J8-W0093-00-00

Kit Includes:

Qty	Description	Part #
3	Gasket	6J8-14198-00-00
3	Gasket, Float Chamber	6J8-14984-00-00
3	Gasket	6J8-14995-00-00
3	Float	6J8-14985-00-00
3	Valve, Needle	6E5-14546-00-00
3	Clip	6J8-14159-00-00
3	Pin, Float Arm	6J8-14548-00-00
3	Plug	6J8-14966-00-00
3	Plug	6J8-14126-00-00
3	Plug	6J8-14118-00-00
3	Screw, With Washer	97980-04112-00

C30 two cyl (94~96) - 61N-W0093-00-00

Kit Includes:

Qty	Description	Part #
1	Valve, Needle	62Y-14392-00-00
1	Pin, Float	6E5-14386-01-00
1	Float	6L2-14385-00-00
1	Gasket	6L2-14399-00-00
1	Plug	50M-14355-00-00
1	Gasket	6L2-14398-00-00
1	Gasket, Float Chamber	6L2-14384-00-00
1	Gasket	61N-14198-00-00
1	O-Ring	93210-40659-00

CV40, CV40 Two Cyl (91~93)

6E9-W0093-02-00

Kit Includes:

Qty	Description	Part #
1	Gasket	6E9-14198-A0-00
2	Screw, With Washer	97980-04114-00
2	Needle Valve Assy	6H3-14590-01-00
2	Gasket, Float Chamber	676-14984-00-00
2	Pin, Float Arm	688-14548-00-00
2	Pin, Float	676-14186-00-00
2	Clip	633-14159-00-00
2	Float	676-14985-01-00
2	Screw, Pilot	692-14923-00-00
2	O-Ring	93210-04228-00
2	O-Ring	93210-04230-00
4	Gasket	688-14126-00-00

C40 two Cyl (94~97) - 6E9-W0093-03-00

Kit Includes:

Qty	Description	Part #
1	Gasket	6E9-14198-A0-00
2	Screw, With Washer	97980-04114-00
2	Needle Valve Assy	6H3-14590-01-00
2	Gasket, Float Chamber	676-14984-00-00
2	Pin, Float Arm	688-14548-00-00
2	Pin, Float	676-14186-00-00
2	Clip	633-14159-00-00
2	Float	676-14985-01-00
2	Screw, Pilot	692-14923-00-00
2	O-Ring	93210-04228-00
2	O-Ring	93210-04230-00
4	Gasket	688-14126-00-00

40, 50, PRO50 (~88) - 6H4-W0093-01-00

Kit Includes:

Qty	Description	Part #
1	Gasket	6H4-14198-09-00
3	Cap	679-14966-00-00
3	Needle Valve Assy	6H3-14590-01-00
3	Clip	633-14159-00-00
3	Pin, Float	676-14186-00-00
3	Float	6G1-14985-00-00
3	Pin, Float Arm	688-14548-00-00
3	O-Ring	6G1-14984-00-00
3	Screw, With Washer	97980-04114-00
3	O-Ring	93210-04230-00
3	Gasket	663-14126-00-00
3	Gasket	688-14126-00-00
3	Screw, Pilot	692-14923-00-00
3	O-Ring	93210-15M52-00

40, 50, C50, Pro50 (89~), P40, P50, PR50, C40 Three Cyl - 6H4-W0093-03-00

Kit Includes:

Qty	Description	Part #
3	Gasket	6H4-14198-01-00
3	Cap	679-14966-00-00
3	Needle Valve Assy	6H4-14590-01-00
3	Clip	633-14159-00-00
3	Pin, Float	676-14186-00-00
3	Float	6H4-14985-01-00
3	Pin, Float Arm	6H4-14548-00-00
3	Gasket, Float Chamber	6H4-14984-00-00
3	Screw, With Washer	97980-04114-00
3	O-Ring	93210-04230-00
3	O-Ring	6H4-14147-00-00
3	Screw, Pilot	692-14923-00-00

E48, C55, CV55 - 696-W0093-02-00

Kit Includes:

Qty	Description	Part #
1	Gasket	663-14483-A0-00
2	Gasket	663-14198-A0-00
2	Washer	679-14557-00-00
2	Screw, Pilot	663-14923-00-00
2	Needle Valve Assy	696-14590-01-00
2	O-Ring	93210-07229-00
2	Pin, Float	676-14186-00-00
2	Float	6F0-14985-00-00
2	Pin, Float Arm	663-14548-00-00
2	O-Ring	93210-64272-00
2	Screw	90159-04007-00
2	O-Ring	93210-04230-00

60 (01~04/2005), P60 (92~99), 70 (92~04/2009), C70 (00~01) - 6H2-W0093-10-00

Kit Includes:

Qty	Description	Part #
1	O-Ring	6H4-14147-00-00
1	O-Ring	93210-04228-00
1	Needle Valve Assy	6H3-14590-01-00
1	Pin, Float Arm	6H4-14548-00-00
1	Clip	633-14159-00-00
1	Pin, Float	676-14186-00-00
1	Cap	679-14966-00-00
1	Gasket, Float Chamber	6H4-14984-00-00
1	O-Ring	93210-04230-00
1	O-Ring	93210-39ME4-00

P60 (91), C60, E60, 70 (90~91)

6H3-W0093-02-00

Kit Includes:

Qty	Description	Part #
1	Gasket	6H3-14198-A1-00
3	Cap	679-14966-00-00
3	Needle Valve Assy	6H3-14590-01-00
3	Clip	633-14159-00-00
3	Pin, Float	676-14186-00-00
3	Float	6G1-14985-00-00
3	Pin, Float Arm	688-14548-00-00
3	O-Ring	6G1-14984-00-00
3	Screw, With Washer	97980-04114-00
3	O-Ring	93210-04230-00
3	Gasket	663-14126-00-00
3	Gasket	688-14126-00-00
3	Screw, Pilot	692-14923-00-00
3	O-Ring	93210-15M52-00

P75, 90, C90 (92~) - 6H1-W0093-10-00

Kit Includes:

Qty	Description	Part #
1	O-Ring	6H4-14147-00-00
1	O-Ring	93210-04228-00
1	Needle Valve Assy	692-14590-01-00
1	Pin, Float Arm	6H4-14548-00-00
1	Clip	633-14159-00-00
1	Pin, Float	676-14186-00-00
1	Cap	679-14966-00-00
1	Gasket, Float Chamber	6H4-14984-00-00
1	O-Ring	93210-04230-00
1	O-Ring	93210-39ME4-00

C75, C80 (98~99) - 6H0-W0093-00-00

Kit Includes:

Qty	Description	Part #
1	O-Ring	93210-04228-00
1	Needle Valve Assy	692-14590-01-00
1	Clip	633-14159-00-00
1	Pin, Float	676-14186-00-00
1	Pin, Float Arm	688-14548-00-00
1	Gasket, Float Chamber	676-14984-00-00
1	Cap	679-14966-00-00
1	O-Ring	93210-04230-00

General Information

Rigging Estimate Guide (Diagrams)

Rigging Components

Electrical Components

Engine Accessories

Propellers

Maintenance Items

Oils & Lubes

Detailing & Trailer Supplies

Accessories & Apparel

Generators & Accessories

Maintenance Items

General Information

Rigging Estimate Guide (Diagrams)

Rigging Components

Electrical Components

Engine Accessories

Propellers

Maintenance Items

Oils & Lubes

Detailing & Trailer Supplies

Accessories & Apparel

Generators & Accessories

C75, C85, CV85, E75 (94~96), 90 (90~91), B90 - 6H1-W0093-01-00

Kit Includes:

Qty	Description	Part #
3	Gasket	688-14198-A2-00
3	O-Ring	93210-04228-00
3	Needle Valve Assy	692-14590-01-00
3	Pin, Float	676-14186-00-00
3	Float	676-14985-01-00
3	Pin, Float Arm	688-14548-00-00
3	Gasket, Float Chamber	676-14984-00-00
3	Screw, With Washer	97980-04114-00
3	O-Ring	93210-04230-00
3	Gasket	663-14126-00-00
3	Screw, Pilot	692-14923-00-00

115, B115, C115, 130 (96~), S115, S130 - 6E5-W0093-09-00

Kit Includes:

Qty	Description	Part #
2	Clip	6E5-14159-00-00
1	Gasket	6E5-14198-A2-00
2	Valve, Needle	6E5-14546-00-00
2	Pin, Float	6E5-14386-02-00
2	Valve, Drain	64D-14394-00-00
1	Gasket, Float Chamber	64D-14384-01-00
2	Gasket	6E5-14398-00-00
2	Plug	6E5-14328-01-00
2	Gasket	6E5-14979-00-00
1	Gasket	6J8-14995-00-00
2	Gasket	61U-14959-00-00

115, 130 (90~91) - 6N6-W0093-02-00

Kit Includes:

Qty	Description	Part #
1	Gasket	6K7-14483-00-00
2	Gasket	6E5-14198-A2-00
4	Valve, Needle	6E5-14546-00-00
4	Pin, Float	6E5-14386-02-00
4	Float	6E5-14385-02-00
2	Gasket, Float Chamber	6E5-14384-03-00
4	O-Ring	6E5-14997-00-00
4	Gasket	6E5-14398-01-00
2	Screw, Panhead	97885-05016-00
2	Washer, Spring	92990-05100-00
4	Screw, Air Adjusting	6E5-14323-03-00
4	Gasket	6E5-14979-00-00
4	Gasket	6J8-14995-00-00
2	Gasket	6E5-14959-01-00

115, C115, 130, 150, 175, 200, 225 2.6L (92~95), P115 (93~96), P150, P175, P200 (92~95) - 6E5-W0093-06-00

Kit Includes:

Qty	Description	Part #
1	Gasket	6E5-14198-A2-00
2	Valve, Needle	6E5-14546-00-00
2	Pin, Float	6E5-14386-02-00
1	Gasket, Float Chamber	6E5-14384-03-00
2	Gasket	6E5-14398-01-00
2	Gasket	6E5-14979-00-00
2	Gasket	6J8-14995-00-00
1	Gasket	6E5-14959-01-00
2	Clip	6E5-14159-00-00
2	Plug Slow Jet	6E5-14394-00-00
2	O-Ring	6E5-14997-00-00
2	Plug	6E5-14328-01-00

150, 175, 200, 225 (90~91), P150, P175 (90~91), P200 (90~91), ProV150 - 6K7-W0093-08-00

Kit Includes:

Qty	Description	Part #
1	Gasket	6K7-14483-00-00
1	Gasket	6E5-14198-A2-00
6	Valve, Needle	6E5-14546-00-00
6	Pin, Float	6E5-14386-02-00
6	Float	6E5-14385-02-00
3	Gasket, Float Chamber	6E5-14384-03-00
6	O-Ring	6E5-14997-00-00
6	Gasket	6E5-14398-01-00
3	Screw, With Washer	97885-05016-00
3	Washer, Spring	92990-05100-00
6	Screw, Air Adjusting	6E5-14323-03-00
6	Gasket	6E5-14979-00-00
6	Gasket	6J8-14995-00-00
3	Gasket	6E5-14959-01-00

150, V150 (02~) - 64D-W0093-01-00

Kit Includes:

Qty	Description	Part #
1	Gasket, Float Chamber	64D-14384-01-00
2	Valve, Needle	6E5-14546-00-00
2	Clip	6E5-14159-00-00
2	Pin, Float	6E5-14386-02-00
2	Gasket	61U-14959-00-00
2	Valve, Drain	64D-14394-00-00
2	Gasket	6E5-14398-01-00
2	Plug	6E5-14328-01-00
2	Gasket	6E5-14979-00-00
1	Gasket	6J8-14995-00-00
1	Gasket	6E5-14198-A2-00

150, V150, 175, 200 (96~01), 225 2.6L (96~), P150, P175, P200 (96~99), S150, C150, S175, S200 - 64D-W0093-00-00

Kit Includes:

Qty	Description	Part #
1	Gasket, Float Chamber	64D-14384-01-00
2	Valve, Needle	6E5-14546-00-00
2	Clip	6E5-14159-00-00
2	Pin, Float	6E5-14386-02-00
2	Gasket	61U-14959-00-00
2	Valve, Drain	64D-14394-00-00
2	Gasket	6E5-14398-01-00
2	Plug	6E5-14328-01-00
2	Gasket	6E5-14979-00-00
1	Gasket	6J8-14995-00-00
1	Gasket	6E5-14198-A2-00

225, 250 3.1L (90~96), S225, S250- 61A-W0093-01-00

Kit Includes:

Qty	Description	Part #
1	Clip	6E5-14159-01-00
1	O-Ring	93210-50MA8-00
1	Gasket	61A-14198-00-00
1	Valve, Needle	6E5-14546-00-00
1	Pin, Float	61A-14386-00-00
1	Valve, Drain	61A-14394-00-00
1	Gasket, Float Chamber	61A-14384-00-00
1	Screw, Air Adjusting	6E5-14323-03-00
1	Gasket	61A-14995-00-00
1	Gasket	61A-14959-00-00
1	O-Ring	61A-14561-00-00

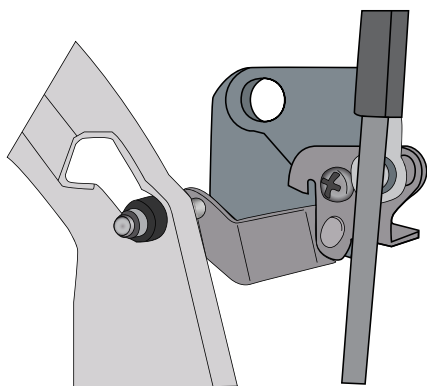

Cam Roller

Cam rollers can wear over time. Stocking a few will help ensure your customers get the quick service they need. Used on most two strokes from 9.9 HP up.

682-41291-00-00

Water Pump Housings

4 Stroke Application	Part Number
F2.5	69M-G4311-00-00
F4 (~06/2008)	68D-G4311-01-00
F4 (09/2009~)	6BX-44311-00-00
F8,T8 (01~) F6 (~06/2008)	63V-44301-00-00
F9.9, T9.9 (~04)	682-44300-01-00
F9.9/T9.9 (05~)	63V-44301-00-00
F15 (98~)	63V-44301-00-00
F15C, F20	6AH-44311-00-00
F25	61N-44311-01-00
T25, F30, F40 (00~)	66T-44311-00-00
F40 (99)	63D-44311-00-00
F50, F60	63D-44311-00-00
T50, T60	6H3-44311-00-00
F70	6CJ-44311-00-00
F75, F80, F90, F100	67F-44311-01-00
F90B, VF90, F115, F115B,F150, F200, F225	61A-44311-01-00
VF200, VF225, VF250	61A-44311-01-00
F225, F250, F300 (4.2L)	6CE-44311-01-00
F250, F250B	61A-44311-01-00
F300, F350 (V8)	6AW-44311-01-00

2 Stroke Application	Part Number
2	99999-02129-00
3	6L5-44311-00-00
4,5	6E0-44311-00-00
6,8	6GH-44311-00-00
9.9/15 (96)	63V-44301-00-00
9.9/15 (~95)	682-44300-01-00
20,25 Two Cyl	6L2-44311-01-00
25,30 Three Cyl	6J8-44311-00-00
C25	689-44311-03-00
C30 (93~97)	61N-44311-01-00
C30 (~92)	689-44311-03-00
40, 50, P50 (~94)	6J8-44311-00-00
40, C40, P40, 50, C50, P50 (95~)	63D-44311-00-00
E48, C55	663-44311-02-00
60, C60, P60, E60 (~03)	6H3-44311-00-00
60,70 (04~), C75, E75, P75, 90	688-44311-01-00
C85 (92~95)	688-44311-01-00
C85 (89~91,96~97)	67F-44311-01-00
115, C115, 130 (~92)	61A-44311-01-00
115, B115, C115, P115, S115 (93~)	61A-44311-01-00
130, S130 (93~)	61A-44311-01-00
150, P150, 175, 200, 225 (~91)	61A-44311-01-00
V150, VX150 (92~)	61A-44311-01-00
150, C150, D150, DX150 (92~)	61A-44311-01-00
P150, PX150, P175, P200 (92~)	61A-44311-01-00
S150, SX150, S200, SX200	61A-44311-01-00
S225, SX225, S250, SX250	61A-44311-01-00
175, 200, 225, 250	61A-44311-01-00
V200, VX200, V225	61A-44311-01-00
VX225,V250, VX250	61A-44311-01-00
VZ150, VZ175, VZ200	61A-44311-01-00
VZ225, VZ250, VZ300	61A-44311-01-00
Z150, Z175, Z200, Z250,Z300	61A-44311-01-00

Jet Drive Application	Part Number
F40	67C-44311-10-00
F50/F60	62Y-44311-10-00
F75/F80/F90/F100	67F-44311-11-00
F115	61A-44311-01-00
(Requires both part numbers)	6E5-44322-00-00

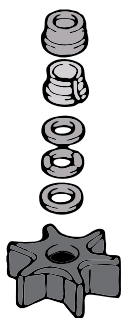

Anti-Knock Washers

Required when changing a water pump on engines utilizing anti-knock washers.

Collar	61A-45527-00-00
Spacer	61A-45538-00-00
Plate Washer	90201-22M01-00
Wave Washer	90206-22M19-00

T8, T9.9 (04/2007~) - 69G-W0078-00-00

Kit Includes:

Qty	Description	Part #
1	Insert, Cartridge	63V-44322-00-00
1	Damper, Water Seal 2	68T-44366-00-00
1	Impeller	63V-44352-01-00
1	Key, Woodruff	664-44338-00-00
1	O-Ring	93210-44704-00
1	Outer Plate, Cartridge	68T-44323-00-00
4	Bolt	97095-08045-00

F9.9, T9.9, FT9.9 (~96) - 682-W0078-A1-00

Kit Includes:

Qty	Description	Part #
2	Gasket, Water Pump	682-44315-A0-00
1	Insert, Cartridge	682-44322-00-00
1	Outer Plate, Cartridge	682-44323-00-00
1	Damper, Water Seal 1	682-44365-00-00
1	Key, Woodruff	90280-03024-00
4	Bolt	97095-06040-00
1	Impeller	682-44352-03-00

F9.9, T9.9, FT9.9 (~96), F9.9, T9.9 (04~04/2005), FT9.9 (04~04/2005) - 682-W0078-A3-00

Kit Includes:

Qty	Description	Part #
1	Damper, Water Seal 1	682-44365-00-00
4	Bolt	97080-06045-00
1	Insert, Cartridge	682-44322-00-00
1	Impeller	682-44352-03-00
2	Gasket, Water Pump	682-44315-A0-00
1	Outer Plate, Cartridge	682-44323-00-00
1	Key, Woodruff	90280-03024-00

F9.9-2, T9.9-2, F15 - 63V-W0078-02-00

Kit Includes:

Qty	Description	Part #
1	Damper, Water Seal 2	647-44366-00-00
4	Bolt	97095-08045-00
1	Insert, Cartridge	63V-44322-00-00
1	Impeller	63V-44352-01-00
1	Outer Plate, Cartridge	63V-44323-00-00
1	Key, Woodruff	664-44338-00-00

4-Stroke Water Pump Repair Kits

F2.5

Parts List (not sold as a kit):

Qty	Description	Part #
1	O-Ring	93210-33M85-00
1	Insert Cartridge	6L5-44322-00-00
1	Outer Plate Cartridge	69M-G4323-00-00
1	Damper, Water Seal 2	6E0-44366-00-00
1	Impeller	6L5-44352-00-00
4	Bolt	97095-06040-00
2	Pin, Dowel	93604-18080-00
2	Plate	69M-G4328-00-00

F4, F6 (09/2009~) - 6EE-W0078-00-00

Kit Includes:

Qty	Description	Part #
1	Housing, Water Pump	6EE-G4311-00-00
1	Gasket, Water Pump	6EE-G4315-00-00
1	Insert, Cartridge	6BX-44322-00-00
1	Outer Plate, Cartridge	6BX-44323-00-00
1	Damper, Water Seal 2	67D-44366-00-00
1	Impeller	6E0-44352-00-00
4	Bolt	97080-06045-00
2	Pin, Dowel	93604-18080-00

F4 (~06/2008) - 68D-WG078-00-00

Kit Includes:

Qty	Description	Part #
1	Housing, Water Pump	68D-G4311-01-00
1	Gasket, Water Pump	6EE-G4315-00-00
1	Insert Cartridge	6E0-44322-02-00
1	Outer Plate, Cartridge	6E0-44323-00-00
1	Damper, Water Seal 2	67D-44366-00-00
1	Impeller	6E0-44352-00-00
4	Bolt	97080-06045-00
2	Pin, Dowel	93604-18080-00

F6, F8 (~06/2008) - 68T-W0078-00-00

Kit Includes:

Qty	Description	Part #
1	Insert, Cartridge	63V-44322-00-00
1	Damper, Water Seal 2	68T-44366-00-00
1	Impeller	68T-44352-00-00
1	Key, Woodruff	664-44338-00-00
1	O-Ring	93210-44704-00
1	Outer Plate, Cartridge	68T-44323-00-00
4	Bolt	97095-08045-00

General Information

Rigging Estimate Guide (Diagrams)

Rigging Components

Electrical Components

Engine Accessories

Propellers

Maintenance Items

Oils & Lubcs

Detailing & Trailer Supplies

Accessories & Apparel

Generators & Accessories

Maintenance Items

General Information

Rigging Estimate Guide (Diagrams)

Rigging Components

Electrical Components

Engine Accessories

Propellers

Maintenance Items

Oils & Lubes

Detailing & Trailer Supplies

Accessories & Apparel

Generators & Accessories

F15C, F20 - 6AH-W0078-00-00

Kit Includes:

Qty	Description	Part #
1	Housing, Water Pump	6AH-44311-00-00
1	Insert, Cartridge	63V-44322-00-00
1	Damper, Water Seal	6L2-44367-00-00
1	Impeller	63V-44352-01-00
1	Key, Woodruff	664-44338-00-00
1	O-Ring	93210-49046-00
1	Outer Plate, Cartridge	68T-44323-00-00
2	Pin, Dowel	93604-10M03-00
4	Bolt	97095-08045-00
2	Plate	63V-44328-01-00

F25 - 61N-W0078-11-00

Kit Includes:

Qty	Description	Part #
1	Insert, Cartridge	63V-44322-00-00
1	Damper, Water Seal 3	6L2-44367-00-00
1	Impeller	63V-44352-01-00
1	Key, Woodruff	664-44338-00-00
1	O-Ring	93210-49046-00
1	Outer Plate, Cartridge	68T-44323-00-00
2	Pin, Dowel	93604-10M03-00
4	Bolt	97095-08045-00
2	Plate	63V-44328-01-00

T25, F30, F40 (00~2009) - 66T-W0078-00-00

Kit Includes:

Qty	Description	Part #
1	Insert, Cartridge	63D-44322-00-00
1	Outer Plate, Cartridge	66T-44323-00-00
1	O-Ring	93210-59MG7-00
1	Gasket, Water Pump	63D-44316-00-00
1	Key, Woodruff	90280-03M03-00
1	Impeller	6H4-44352-02-00
4	Bolt, With Washer	90119-08M15-00
1	Damper, Water Seal 2	663-44366-00-00
1	Pump Housing Cover	63D-44312-00-00

F40 (99), F50 (97~), F60 (02~)

63D-W0078-01-00

Kit Includes:

Qty	Description	Part #
1	Insert, Cartridge	63D-44322-00-00
1	Impeller	6H3-44352-00-00
1	Cover, Water Pump Housing	63D-44312-00-00
1	Outer Plate, Cartridge	63D-44323-00-00
1	O-Ring	93210-59MG7-00
1	Gasket, Water Pump	63D-44316-00-00
4	Bolt, With Washer	90119-08M15-00
1	Damper, Water Seal 2	663-44366-00-00
1	Key, Woodruff	90280-03024-00

F40 (2010~) - 6BG-W0078-00-00

Kit Includes:

Qty	Description	Part #
1	Pump Housing Cover	63D-44312-00-00
1	Gasket, Water Pump	63D-44316-00-00
1	Insert Cartridge	63D-44322-00-00
1	Outer Plate , Cartridge	63D-44323-00-00
1	Damper, Water Seal 2	663-44366-00-00
1	Impeller	6H4-44352-02-00
4	Bolt, With Washer	90119-08M15-00
1	Key, Woodruff	90280-03M03-00
1	O-Ring	93210-59MG7-00

F75, F80, F90, F100 - 67F-W0078-00-00

Kit Includes:

Qty	Description	Part #
1	Insert, Cartridge	67F-44322-00-00
1	Impeller	67F-44352-00-00
1	Gasket, Water Pump	688-44315-A0-00
1	Outer Plate, Cartridge	67F-44323-00-00
1	Gasket, Cartridge	688-44324-A0-00
1	Gasket, Water Pump	688-44316-A0-00
1	O-Ring	93210-46044-00
2	Bolt, With Washer	90119-08M87-00
2	Bolt, With Washer	90119-08M13-00
1	Key, Woodruff	90280-04M04-00

F115 (00~01) - 6N6-W0078-02-00

Kit Includes:

Qty	Description	Part #
1	Insert, Cartridge	61A-44322-02-00
1	O-Ring	93210-86M38-00
1	O-Ring	93210-37M67-00
1	Impeller	6E5-44352-01-00
1	Outer Plate, Cartridge	6E5-44323-00-00
1	Gasket, Water Pump	6E5-44315-A0-00
2	Pin, Dowel	93606-12019-00
4	Bolt, With Washer	90119-08M14-00
1	Key, Woodruff	90280-04M05-00
1	Key, Woodruff	90280-04M04-00

F115 (02~) - 68V-W0078-00-00

Kit Includes:

Qty	Description	Part #
1	Insert, Cartridge	61A-44322-02-00
1	O-Ring	93210-86M38-00
1	O-Ring	93210-37M67-00
1	Impeller	6E5-44352-01-00
1	Outer Plate, Cartridge	6EK-44323-00-00
1	Gasket, Water Pump	6E5-44315-A0-00
2	Pin, Dowel	93606-12019-00
4	Bolt, With Washer	90119-08M14-00
1	Key, Woodruff	90280-04M05-00

F50, T50 (96) - 6H3-W0078-A0-00

Kit Includes:

Qty	Description	Part #
1	Gasket, Water Pump	6H3-44315-A0-00
1	Outer Plate, Cartridge	6H3-44323-00-00
1	Gasket, Cartridge	6H3-44324-A0-00
1	Impeller	6H3-44352-00-00
1	Insert, Cartridge	663-44322-00-00
1	Gasket, Water Pump	688-44316-A0-00
1	Key, Woodruff	90280-03M03-00
1	O-Ring	93210-46044-00
4	Bolt	97095-08055-00
4	Bolt	97095-08045-00

T50, T60 (97~) - 6H3-W0078-02-00

Kit Includes:

Qty	Description	Part #
1	Insert, Cartridge	663-44322-00-00
1	Impeller	6H3-44352-00-00
1	Gasket, Water Pump	6H3-44315-A0-00
1	Outer Plate, Cartridge	6H3-44323-00-00
1	Gasket, Cartridge	6H3-44324-A0-00
1	Gasket, Water Pump	688-44316-A0-00
1	O-Ring	93210-46044-00
2	Bolt, With Washer	90119-08M14-00
2	Bolt, With Washer	90119-08M33-00
1	Key, Woodruff	90280-03M03-00

F70 - 6CJ-W0078-00-00

Kit Includes:

Qty	Description	Part #
1	Insert, Cartridge	63D-44322-00-00
1	Gasket, Water Pump	6CJ-44315-00-00
1	Cover, Pump Housing	63D-44312-00-00
1	Damper, Water Seal 2	663-44366-00-00
1	Impeller	6H3-44352-00-00
1	Key, Woodruff	90280-03M03-00
2	Oil Seal	93101-23070-00
1	O-Ring	93210-46044-00
1	Gasket, Water Pump	6CJ-44316-00-00
1	Outer Plate, Cartridge	6CJ-44323-00-00
1	Gasket, Cartridge	6CJ-44324-00-00
2	Pin, Dowel	93604-10M03-00
2	Bolt, With Washer	90119-08M33-00
2	Bolt, With Washer	90119-08M14-00

General Information

Rigging Estimate Guide (Diagrams)

Rigging Components

Electrical Components

Engine Accessories

Propellers

Maintenance Items

Oils & Lubes

Detailing & Trailer Supplies

Accessories & Apparel

Generators & Accessories

Maintenance Items

General Information

Rigging Estimate Guide (Diagrams)

Rigging Components

Electrical Components

Engine Accessories

Propellers

Maintenance Items

Oils & Lubes

Detailing & Trailer Supplies

Accessories & Apparel

Generators & Accessories

F150, F200, F225 - 61A-W0078-A3-00

Kit Includes:

Qty	Description	Part #
1	Insert, Cartridge	61A-44322-02-00
1	O-Ring	93210-86M38-00
1	O-Ring	93210-37M67-00
1	Impeller	6E5-44352-01-00
1	Outer Plate, Cartridge	6G5-44323-01-00
1	Gasket, Water Pump	6E5-44315-A0-00
2	Pin, Dowel	93606-12019-00
4	Bolt, With Washer	90119-08M14-00
1	Key, Woodruff	90280-04M05-00

F300, F350 (V8) - 6AW-W0078-00-00

Kit Includes:

Qty	Description	Part #
1	Insert, Cartridge	6AW-44322-00-00
1	O-Ring	93210-94003-00
1	O-Ring	93210-37M67-00
1	Impeller	6AW-44352-00-00
1	Key	6AW-44336-00-00
1	Outer Plate, Cartridge	6AW-44323-00-00
1	Gasket, Water Pump	6AW-44315-00-00
2	Pin, Dowel	93606-12019-00
4	Bolt, With Washer	90119-08M14-00

VF200, VF225, VF250 - 6CB-W0078-00-00

Kit Includes:

Qty	Description	Part #
1	Insert, Cartridge	61A-44322-02-00
1	O-Ring	93210-86M38-00
1	O-Ring	93210-37M67-00
1	Impeller	6E5-44352-01-00
1	Key, Woodruff	90280-04002-00
1	Outer Plate, Cartridge	6CB-44323-00-00
1	Gasket, Water Pump	6CB-44315-00-00
2	Pin, Dowel	93606-12019-00
4	Bolt, With Washer	90119-08M14-00

F250, F250B - 6P2-W0078-00-00

Kit Includes:

Qty	Description	Part #
1	Insert, Cartridge	61A-44322-02-00
1	O-Ring	93210-86M38-00
1	O-Ring	93210-37M67-00
1	Impeller	6E5-44352-01-00
1	Outer Plate, Cartridge	6P2-44323-00-00
1	Gasket, Water Pump	60X-44315-A0-00
2	Pin, Dowel	93606-12019-00
4	Bolt, With Washer	90119-08M14-00
1	Key, Woodruff	90280-04M05-00

F225, F250, F300 (4.2L) - 6CE-W0078-01-00

Kit Includes:

Qty	Description	Part #
2	Oil Seal	93104-22M07-00
1	Insert, Cartridge	6AW-44322-00-00
1	O-Ring	93210-94003-00
1	O-Ring	93210-37M67-00
1	Impeller	6CE-44352-00-00
1	Key, Woodruff	90280-04002-00
1	Outer Plate, Cartridge	6CE-44323-01-00
1	Gasket, Water Pump	6CE-44315-00-00
2	Pin, Dowel	93606-12019-00
4	Bolt, With Washer	90119-08M14-00

XTO® 425 (2018~) - 6GR-W0078-00-00

Kit Includes:

Qty	Description	Part #
1	Insert, Cartridge	6GR-44322-00-00
1	O-Ring	93210-97690-00
1	O-Ring	93211-08001-00
1	O-Ring	93210-37160-00
1	Impeller	6GR-44352-00-00
1	Outer Plate, Cartridge	6GR-44323-00-00
2	Pin, Dowel	93606-12019-00
4	Bolt, With Washer	90119-08M16-00
1	Key	6AW-44336-00-00

4, 5 (97~) - 6E0-W0078-A3-00

Kit Includes:

Qty	Description	Part #
1	Housing, Water Pump	6E0-44311-00-00
1	Gasket, Water Pump	6E0-44315-A0-00
1	Insert, Cartridge	6E0-44322-02-00
1	Outer Plate, Cartridge	6E0-44323-00-00
1	Damper, Water Seal 2	6E0-44366-00-00
1	Impeller	6E0-44352-00-00
4	Bolt	97095-06045-00
2	Pin Dowel	93604-18080-00

6, 8 (96~) - 6N0-W0078-A0-00

Kit Includes:

Qty	Description	Part #
1	Gasket, Water Pump	6G1-44315-A0-00
1	Insert, Cartridge	6G1-44322-00-00
1	Outer Plate, Cartridge	6G1-44323-00-00
1	Damper, Water Seal 2	647-44366-00-00
1	Impeller	6G1-44352-00-00
2	Plate	6G1-44328-00-00
4	Bolt	97080-06045-00

9.9, 15 (~95) - 682-W0078-A1-00

Kit Includes:

Qty	Description	Part #
2	Gasket, Water Pump	682-44315-A0-00
1	Insert, Cartridge	682-44322-00-00
1	Outer Plate, Cartridge	682-44323-00-00
1	Damper, Water Seal 1	682-44365-00-00
1	Key, Woodruff	90280-03024-00
4	Bolt	97095-06040-00
1	Impeller	682-44352-03-00

9.9, 15 (96~) - 63V-W0078-02-00

Kit Includes:

Qty	Description	Part #
1	Damper, Water Seal 2	647-44366-00-00
4	Bolt	97095-08045-00
1	Insert, Cartridge	63V-44322-00-00
1	Impeller	63V-44352-01-00
1	Outer Plate, Cartridge	63V-44323-00-00
1	Key, Woodruff	664-44338-00-00

2-Stroke Water Pump Repair Kits

2 (89~02) - 6GD-W0078-00-00

Kit Includes:

Qty	Description	Part #
2	Pin, Dowel	93604-09068-00
1	O-Ring	93210-19123-00
2	Oil Seal	93101-11M44-00
1	Outer Plate, Cartridge	646-44323-00-00
1	Impeller	646-44352-01-00
1	Insert, Cartridge	646-44322-00-00
1	Protector, Oil Seal	6GD-44325-00-00
2	Bolt	97095-05016-00

3 (88~02) - 6L5-W0078-00-00

Kit Includes:

Qty	Description	Part #
1	O-Ring	93210-33M85-00
1	Insert, Cartridge	6L5-44322-00-00
1	Outer Plate, Cartridge	6L5-44323-00-00
1	Damper, Water Seal 2	6E0-44366-00-00
1	Impeller	6L5-44352-00-00
4	Bolt	97095-06040-00
2	Pin, Dowel	93604-18080-00
2	Plate	6L5-44328-00-00

4, 5 (~96) - 6E0-W0078-A2-00

Kit Includes:

Qty	Description	Part #
1	Housing, Water Pump	6E0-44311-00-00
1	Gasket, Water Pump	6E0-44315-A0-00
1	Insert, Cartridge	6E0-44322-02-00
1	Outer Plate, Cartridge	6E0-44323-00-00
1	Impeller	6E0-44352-00-00
1	Damper, Water Seal 2	6E0-44366-00-00
1	Pin, Dowel	93604-09066-00
4	Bolt	97080-06045-00

General Information

Rigging Estimate Guide (Diagrams)

Rigging Components

Electrical Components

Engine Accessories

Propellers

Maintenance Items

Oils & Lubes

Detailing & Trailer Supplies

Accessories & Apparel

Generators & Accessories

Maintenance Items

General Information

Rigging Estimate Guide (Diagrams)

Rigging Components

Electrical Components

Engine Accessories

Propellers

Maintenance Items

Oils & Lubes

Detailing & Trailer Supplies

Accessories & Apparel

Generators & Accessories

20, 25 Two Cylinder - 6L2-W0078-00-00

Kit Includes:

Qty	Description	Part #
1	Outer Plate, Cartridge	6L2-44323-00-00
1	O-Ring	93210-45161-00
1	Impeller	6L2-44352-00-00
1	Insert, Cartridge	6L2-44322-00-00
4	Bolt	97095-06040-00
1	Key, Woodruff	90280-03024-00

25, 30 Three Cylinder (96~02)

6J8-W0078-A2-00

Kit Includes:

Qty	Description	Part #
1	Insert, Cartridge	663-44322-00-00
1	Impeller	6H4-44352-02-00
1	Gasket, Water Pump	663-44315-A0-00
1	Outer Plate, Cartridge	663-44323-00-00
1	Gasket, Cartridge	663-44324-A0-00
1	Gasket, Water Pump	663-44316-A0-00
2	Bolt, With Washer	90119-08M13-00
2	Bolt, With Washer	90119-08M34-00

C25 (90~97), C30 (90~92) - 689-W0078-A6-00

Kit Includes:

Qty	Description	Part #
1	Damper, Water Seal 1	626-44365-01-00
1	Housing, Water Pump	689-44311-03-00
3	Bolt, With Washer	90119-06M07-00
1	Insert, Cartridge	689-W4432-02-00
1	Outer Plate, Cartridge	689-44323-03-00
1	Gasket, Cartridge	689-44324-A0-00
1	Impeller	689-44352-02-00
1	Gasket, Water Pump	689-44316-A0-00
1	Key, Woodruff	664-44338-00-00

30 (~95) - 6J8-W0078-A1-00

Kit Includes:

Qty	Description	Part #
1	Impeller	6H4-44352-02-00
1	Gasket, Water Pump	663-44315-A0-00
1	Gasket, Water Pump	663-44316-A0-00
1	Insert, Cartridge	663-44322-00-00
1	Outer Plate, Cartridge	663-44323-00-00
1	Gasket, Cartridge	663-44324-A0-00
2	Bolt	97095-08040-00
2	Bolt	97095-08050-00

C30 (93~97) - 61N-W0078-11-00

Kit Includes:

Qty	Description	Part #
1	Housing, Water Pump	61N-44311-01-00
1	Damper, Water Seal 3	6L2-44367-00-00
1	Insert, Cartridge	61N-44322-01-00
1	Impeller	6H4-44352-02-00
1	O-Ring	93210-45161-00
1	Outer Plate, Cartridge	61N-44323-00-00
4	Bolt	97095-06040-00
4	Washer	92990-06600-00
1	Key, Woodruff	90280-03024-00

40, 50 P50, (~96) - 63D-W0078-00-00

Kit Includes:

Qty	Description	Part #
1	Gasket, Water Pump	63D-44316-00-00
1	Outer Plate, Cartridge	63D-44323-00-00
1	Impeller	6H3-44352-00-00
1	Insert, Cartridge	63D-44322-00-00
1	Gasket, Water Pump	63D-44316-00-00
1	Key, Woodruff	90280-03024-00
1	O-Ring	93210-59MG7-00
4	Bolt	97080-08030-00
4	Washer, Special Shape	90209-08M02-00

40, C40 (98~03, P40, 50, C50, P50 (97~) - 63D-W0078-01-00

Kit Includes:

Qty	Description	Part #
1	Insert, Cartridge	63D-44322-00-00
1	Impeller	6H3-44352-00-00
1	Cover, Pump Housing	63D-44312-00-00
1	Outer Plate, Cartridge	63D-44323-00-00
1	O-Ring	93210-59MG7-00
1	Gasket, Water Pump	63D-44316-00-00
4	Bolt, With Washer	90119-08M15-00
1	Damper, Water Seal 2	663-44366-00-00
1	Key, Woodruff	90280-03024-00

C55 (90~91) - 663-W0078-A0-00

Kit Includes:

Qty	Description	Part #
1	Gasket, Water Pump	663-44315-A0-00
1	Insert, Cartridge	663-44322-00-00
1	Outer Plate, Cartridge	663-44323-00-00
1	Gasket, Cartridge	663-44324-A0-00
1	Damper, Water Seal 2	663-44366-00-00
1	Impeller	6H3-44352-00-00
1	Key, Woodruff	90280-03024-00
2	Bolt	97095-08045-00
2	Bolt	97095-08055-00

C55 (92~94) - 663-W0078-01-00

Kit Includes:

Qty	Description	Part #
1	Insert, Cartridge	663-44322-00-00
1	Impeller	6H3-44352-00-00
1	Gasket, Water Pump	663-44315-A0-00
1	Outer Plate, Cartridge	663-44323-00-00
1	Gasket, Cartridge	663-44324-A0-00
2	Bolt	97095-08055-00
2	Bolt	97095-08045-00
1	Damper, Water Seal 2	663-44366-00-00
1	Key, Woodruff	90280-03M03-00

60, 70 (04~), C75, P75, C80, 90, B90, C90 (97~), E75 - 692-W0078-02-00

Kit Includes:

Qty	Description	Part #
1	Insert, Cartridge	688-44322-00-00
1	Impeller	688-44352-03-00
1	Gasket, Water Pump	688-44315-A0-00
1	Outer Plate, Cartridge	688-44323-00-00
1	Gasket, Cartridge	688-44324-A0-00
1	Gasket, Water Pump	688-44316-A0-00
1	O-Ring	93210-46044-00
2	Bolt, With Washer	90119-08M13-00
2	Bolt, With Washer	90119-08M16-00
1	Key, Woodruff	90280-04M04-00

CV40 (90) - 6F5-W0078-A0-00

Kit Includes:

Qty	Description	Part #
1	Damper, Water Seal 2	663-44366-00-00
1	Insert, Cartridge	676-44322-00-00
1	Impeller	6F5-44352-00-00
1	Gasket, Water Pump	676-44315-A1-00
1	Outer Plate, Cartridge	676-44323-00-00
1	Gasket, Cartridge	676-44324-A1-00
1	Gasket, Water Pump	679-44316-A0-00
2	Bolt	97095-08055-00
2	Bolt	97095-08045-00
4	Washer	92990-08600-00
1	Key, Woodruff	90280-04M00-00

C40 (91~97) - 679-W0078-A1-00

Kit Includes:

Qty	Description	Part #
1	Damper, Water Seal 2	663-44366-00-00
1	Insert, Cartridge	676-44322-00-00
1	Impeller	6F5-44352-00-00
1	Gasket, Water Pump	676-44315-A1-00
1	Outer Plate, Cartridge	676-44323-00-00
1	Gasket, Cartridge	676-44324-A1-00
1	Gasket, Water Pump	679-44316-A0-00
2	Bolt	97095-08055-00
2	Bolt	97095-08045-00
1	Key, Woodruff	90280-04M00-00

E48 (95~00) - 696-W0078-00-00

Kit Includes:

Qty	Description	Part #
1	Insert, Cartridge	663-44322-40-00
1	Impeller	6H3-44352-00-00
1	Gasket, Water Pump	663-44315-A0-00
1	Outer Plate, Cartridge	670-44323-00-00
1	Gasket, Cartridge	663-44324-A0-00
2	Bolt	97095-08055-00
2	Bolt	97095-08045-00
1	Damper, Water Seal 2	663-44366-00-00
1	Key, Woodruff	90280-03M03-00

General Information

Rigging Estimate Guide (Diagrams)

Rigging Components

Electrical Components

Engine Accessories

Propellers

Maintenance Items

Oils & Lubes

Detailing & Trailer Supplies

Accessories & Apparel

Generators & Accessories

Maintenance Items

General Information

Rigging Estimate Guide (Diagrams)

Rigging Components

Electrical Components

Engine Accessories

Propellers

Maintenance Items

Oils & Lubes

Detailing & Trailer Supplies

Accessories & Apparel

Generators & Accessories

E60 (97~00) - 6K5-W0078-01-00

Kit Includes:

Qty	Description	Part #
1	Insert, Cartridge	663-44322-40-00
1	Impeller	6H3-44352-00-00
1	Gasket, Water Pump	6H3-44315-A0-00
1	Outer Plate, Cartridge	6H3-44323-40-00
1	Gasket, Cartridge	6H3-44324-A0-00
1	Gasket, Water Pump	688-44316-A0-00
1	O-Ring	93210-46044-00
2	Bolt, With Washer	90119-08M33-00
2	Bolt, With Washer	90119-08M14-00
1	Key, Woodruff	90280-03M03-00

60, C60, P60, 70, C70 (97~03)

6H3-W0078-02-00

Kit Includes:

Qty	Description	Part #
1	Insert Cartridge	663-44322-00-00
1	Impeller	6H3-44352-00-00
1	Gasket, Water Pump	6H3-44315-A0-00
1	Outer Plate, Cartridge	6H3-44323-00-00
1	Gasket, Cartridge	6H3-44324-A0-00
1	Gasket, Water Pump	688-44316-A0-00
1	O-Ring	93210-46044-00
2	Bolt, With Washer	90119-08M14-00
2	Bolt, With Washer	90119-08M33-00
1	Key, Woodruff	90280-03M03-00

C60, E60, P60, 70 (92~96) - 6H3-W0078-01-00

Kit Includes:

Qty	Description	Part #
1	Insert, Cartridge	663-44322-00-00
1	Impeller	6H3-44352-00-00
1	Gasket, Water Pump	6H3-44315-A0-00
1	Outer Plate, Cartridge	6H3-44323-00-00
1	Gasket, Cartridge	6H3-44324-A0-00
1	Gasket, Water Pump	688-44316-A0-00
1	O-Ring	93210-46044-00
2	Bolt	97095-08045-00
2	Bolt	97095-08055-00
1	Key, Woodruff	90280-03M03-00

C85 (91), CV85 (89~90), 90 (84~91) - 692-W0078-A0-00

Kit Includes:

Qty	Description	Part #
1	Gasket, Water Pump	688-44315-A0-00
1	Gasket, Water Pump	688-44316-A0-00
1	Insert, Cartridge	688-44322-00-00
1	Outer Plate, Cartridge	688-44323-00-00
1	Gasket, Cartridge	688-44324-A0-00
1	Impeller	688-44352-03-00
1	Key, Woodruff	90280-04M04-00
1	O-Ring	93210-46044-00
2	Bolt	97095-08050-00
2	Bolt	97095-08070-00

E75 (95~96), P75 (96), C75 (94~96), C85, 90 (92~96) - 692-W0078-01-00

Kit Includes:

Qty	Description	Part #
1	Insert, Cartridge	688-44322-00-00
1	Impeller	688-44352-03-00
1	Gasket, Water Pump	688-44315-A0-00
1	Outer Plate, Cartridge	688-44323-00-00
1	Gasket, Cartridge	688-44324-A0-00
1	Gasket, Water Pump	688-44316-A0-00
1	O-Ring	93210-46044-00
2	Bolt	97095-08050-00
2	Bolt	97095-08070-00
1	Key, Woodruff	90280-04M04-00

115, C115, 130 (~92) - 6E5-W0078-A1-00

Kit Includes:

Qty	Description	Part #
1	Gasket, Water Pump	6E5-44315-A0-00
1	Insert, Cartridge	6E5-44322-00-00
1	Outer Plate, Cartridge	6E5-44323-00-00
1	Impeller	6E5-44352-01-00
4	Washer	90209-08M02-00
1	Key, Woodruff	90280-04M05-00
1	O-Ring	93210-37M67-00
1	O-Ring	93210-86M38-00
2	Pin, Dowel	93606-12019-00
4	Bolt	97080-08045-00

**115, C115, P115, S115 (96~99),
130 (93~96) - 6N6-W0078-00-00**

Kit Includes:

Qty	Description	Part #
1	Insert, Cartridge	61A-44322-00-00
1	O-Ring	93210-86M38-00
1	O-Ring	93210-37M67-00
1	Impeller	6E5-44352-01-00
1	Outer Plate, Cartridge	6E5-44323-00-00
1	Gasket, Water Pump	6E5-44315-A0-00
1	Pin, Dowel	93606-12019-00
4	Bolt	97095-08045-00
4	Washer	90209-08M02-00
1	Key, Woodruff	90280-04M05-00

115, C115 (97~) - 6N6-W0078-02-00

Kit Includes:

Qty	Description	Part #
1	Insert, Cartridge	61A-44322-02-00
1	O-Ring	93210-86M38-00
1	O-Ring	93210-37M67-00
1	Impeller	6E5-44352-01-00
1	Outer Plate, Cartridge	6E5-44323-00-00
1	Gasket, Water Pump	6E5-44315-A0-00
2	Pin, Dowel	93606-12019-00
4	Bolt, With Washer	90119-08M14-00
1	Key, Woodruff	90280-04M05-00

150, P150, 175, 200, 225 (~91)

6G5-W0078-A1-00

Kit Includes:

Qty	Description	Part #
1	Gasket, Water Pump	6E5-44315-A0-00
1	Insert, Cartridge	6E5-44322-00-00
1	Impeller	6E5-44352-01-00
1	Outer Plate, Cartridge	6G5-44323-01-00
4	Washer	90209-08M02-00
1	Key, Woodruff	90280-04M05-00
1	O-Ring	93210-37M67-00
1	O-Ring	93210-86M38-00
1	Pin, Dowel	93606-12019-00
4	Bolt	97080-08045-00

D150, DX150, B115 (97~99) - 65N-W0078-A1-00

Kit Includes:

Qty	Description	Part #
1	Insert, Cartridge	61A-44322-02-00
1	O-Ring	93210-86M38-00
1	O-Ring	93210-37M67-00
1	Impeller	6E5-44352-01-00
1	Outer Plate, Cartridge	65N-44323-00-00
1	Gasket, Water Pump	65N-44315-A0-00
1	Key, Woodruff	90280-04M05-00
2	Pin, Dowel	93606-12019-00
4	Bolt, With Washer	90119-08M14-00

**P150 (92~96), P175 (94~96), P200 (91~96),
C150 (96), 150~225 (96), L150~L250 (96),
S150~S250 (96) - 61A-W0078-A1-00**

Kit Includes:

Qty	Description	Part #
1	Insert, Cartridge	61A-44322-00-00
1	O-Ring	93210-86M38-00
1	O-Ring	93210-37M67-00
1	Impeller	6E5-44352-01-00
1	Outer Plate, Cartridge	6G5-44323-01-00
1	Gasket, Water Pump	6E5-44315-A0-00
2	Pin, Dowel	93606-12019-00
4	Bolt	97095-08045-00
4	Washer	90209-08M02-00
1	Key, Woodruff	90280-04M05-00

VZ200 (3.1L),

VZ225~VZ300 (03~) - 60X-W0078-00-00

Kit Includes:

Qty	Description	Part #
1	Insert, Cartridge	61A-44322-02-00
1	O-Ring	93210-86M38-00
1	O-Ring	93210-37M67-00
1	Impeller	6E5-44352-01-00
1	Outer Plate, Cartridge	60X-44323-00-00
1	Gasket, Water Pump	60X-44315-A0-00
2	Pin, Dowel	93606-12019-00
4	Bolt, With Washer	90119-08M14-00
1	Key, Woodruff	90280-04M05-00

General Information

Rigging Estimate Guide (Diagrams)

Rigging Components

Electrical Components

Engine Accessories

Propellers

Maintenance Items

Oils & Lubes

Detailing & Trailer Supplies

Accessories & Apparel

Generators & Accessories

225,250 (92~), S150, SX150, S200, SX200, S250, SX250, V150~V250, VX150~VX250, VZ150~VZ200 (2.6L), Z150~Z300, P150~P200, C150 (97~99), PX150 (99) - 61A-W0078-A3-00

Kit Includes:

Qty	Description	Part #
1	Insert, Cartridge	61A-44322-02-00
1	O-Ring	93210-86M38-00
1	O-Ring	93210-37M67-00
1	Impeller	6E5-44352-01-00
1	Outer Plate, Cartridge	6G5-44323-01-00
1	Gasket, Water Pump	6E5-44315-A0-00
2	Pin, Dowel	93606-12019-00
4	Bolt, With Washer	90119-08M14-00
1	Key, Woodruff	90280-04M05-00

REMINDER

Don't forget the WR No. 2 grease for the driveshaft splines when reinstalling the lower unit after water services.

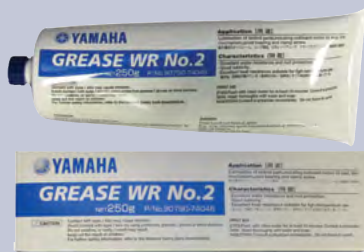

WR No. 2 Grease

Provides water resistance, rust protection, lubrication and heat resistance. Specially designed for four stroke oil pump seals, drive shaft splines and drive shaft bushing area. For four stroke and two stroke applications.

90790-74046-00

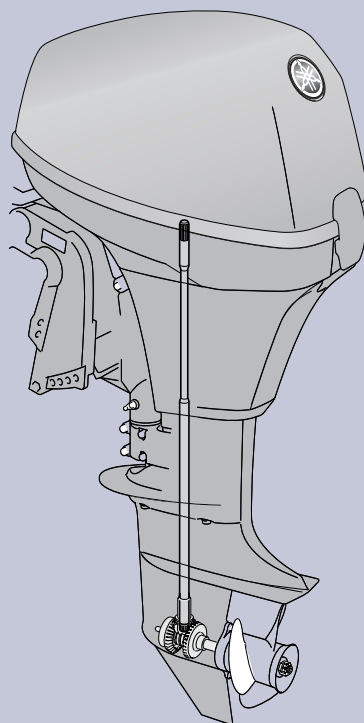



Description	Page
Oil and Lubes POP (Point of Purchase) Material	8-1
Outboard Engine Oil	8-2
Oil Change Kits	8-3
Pumps and Spouts	8-4
Fuel Additives	8-6
Grease	8-7
Yamabond® Adhesives	8-9
Threadlock	8-9
Shop Supplies	8-10
Marine Spray Paint by Yamalube®	8-11
For the Technician	8-12
YDIS (Yamaha Diagnostic System)	8-14

General
Information

Rigging Estimate
Guide (Diagrams)

Rigging
Components

Electrical
Components

Engine
Accessories

Propellers

Maintenance
Items

**Oils
& Lubes**

Detailing &
Trailer Supplies

Accessories
& Apparel

Generators
& Accessories



Oil and Lubes POP Material

YAMALUBE® Marine Performance

There are many reasons you chose a Yamaha Outboard. Performance, Technology, Durability, and an enjoyable boating experience you can look forward to thanks to Yamaha's legendary reliability. Using Genuine Yamaha oils and maintenance parts along with a regular maintenance schedule can help your customers get the most out of their engines and their boating experience.

Yamaha offers a variety of material to help you convey the importance of proper maintenance and the advantage of Genuine Yamaha parts, most at little or no cost to you.

Point of Purchase Items:

YAMALUBE® Counter Mats: **LIT-CNTRM-AT-01**

Ethanol Defense Brochures: **LIT-ETHDF-NS-12**

Maintenance Matters® Brochures: **LIT-MNTMT-RS-15**

Trailer Tongue Guards (5 pack): **LIT-TRTNG-GR-D0**

Introduction to Outboards Training Material:

Instructors Guide: **MAR-TTRNG-01-00**

Student Guide: **MARTTRNG-00-00**



Outboard Engine Oil

Yamalube® 2M- Two Stroke for Outboards

NMMA® TC-W3®-Certified, 2M premium two stroke blend delivers superior lubrication and anti-wear/anti-rust protection for outboard engines operating in demanding marine environments. Provides the highest level of protection on the market. Semi-synthetic oil with an exclusive additive blend works to guard against ring stick and carbon build up, while special additives minimize wear. This oil is designed for the most grueling conditions two stroke outboards face. Whether it's extended full-throttle operation, engine-punishing "out of the hole" acceleration, or hour after hour of trolling, this oil can take it. With its extreme level of performance, Yamalube 2M offers the best everyday protection, too. *Not recommended for WaveRunner® Personal Watercraft or Sport Boats.*



YAMALUBE 4M FC-W® Full Synthetic SAE 5W-30

Group IV fully synthetic oil offers our best outboard lubrication and performance, and it's FC-W® rated by the National Marine Manufacturers Association (NMMA®). Contains all of the benefits of mineral oil based Yamalube 4M, with increased lubricity for lower friction levels and potentially improved fuel economy. Specific marine additives help combat rust, corrosion, varnish, and wear; all while providing high levels of bearing protection, resistance to foaming, and lubrication.



Yamalube 4M FC-W® for Four Stroke Outboards

In order for an oil to be approved by the NMMA® to hold its highest rating for marine engine oils, FC-W® (Four Cycle – Water cooled) it must pass a multitude of tests. Passenger car oils don't pass these tests, which is why it's important to use NMMA®-Certified Yamalube 4M FC-W®. Automotive oils do not usually run at 6000 rpm. Yamaha Outboard engines were designed to run at full throttle (5500 to 6000 rpm) all day long. At this speed it is critical that engine oil not foam. Foaming reduces lubricity which can lead to wear and over time this can lead to failure. Yamalube 4M FC-W® has the best blend of anti-foam technology available.



YAMALUBE® Oil	Quart Bottles (Minimum Order Qty 12)	One Gallon Bottles (Minimum Order Qty 4)	2.5 Gallon Bottles (Minimum Order Qty 2)	55 Gallon Drum (Minimum Order Qty 1)
2M Two Stroke Oil	LUB-2STRK-M1-12	LUB-2STRK-M1-04	LUB-2STRK-M1-02	LUB-2STRK-M1-55
4M FC-W® 05W-30	LUB-05W30-FC-12	LUB-05W30-FC-04		
4M FC-W® 10W-30	LUB-10W30-FC-12	LUB-10W30-FC-04		LUB-10W30-FC-55
4M FC-W® 20W-40	LUB-20W40-FC-12	LUB-20W40-FC-04		LUB-20W40-FC-55

- General Information
- Rigging Estimate Guide (Diagrams)
- Rigging Components
- Electrical Components
- Engine Accessories
- Propellers
- Maintenance Items
- Oils & Lubes
- Detailing & Trailer Supplies
- Accessories & Apparel
- Generators & Accessories

Outboard Oil Change Kits

Yamaha's oil change kits are designed for the mobile service dealers to provide an easy, all in one oil change package. They're also perfect for the do-it-yourself customer. One stop, one box, and your customer is back on the water. Large, Mid Range, and Medium Kits have a minimum order quantity of 4. Small oil change kits have a minimum order quantity of 6.



Production Years	Model	Oil Change Capacity	05W30 Kit	10W-30 Kit	20W-40 Kit	Min. Order Qty.	Kit Contents
'10~	VF250, VF225, VF200	7.1 Qts.	LUB-MRNSH-KT-05			2	VMAX SHO Kit: 8 quarts of oil, oil filter, and drain screw gasket.
'10~	4.2L V6 Offshore Outboards	6.7 Qts.		LUB-MRNXL-KT-10		2	Extra Large Kit: 7 quarts of oil, oil filter, and drain screw gasket.
'10~	4.2L (B & C) F225 ~ F350	6.7 Qts.			LUB-MRNXL-KT-20		
'05-'10	F250A&B	5.1 Qts.		LUB-MRNLG-KT-10	LUB-MRNLG-KT-20	4	Large Kit: 6 quarts of oil, oil filter, and drain screw gasket
'08-'10	F225 Sport	5.1 Qts.		LUB-MRNLG-KT-10	LUB-MRNLG-KT-20		
'02-'10	F225	5.1 Qts.		LUB-MRNLG-KT-10	LUB-MRNLG-KT-20		
'02-'10	F200	5.1 Qts.		LUB-MRNLG-KT-10	LUB-MRNLG-KT-20		
13~	F200 (In Line)	4.8 Qts.		LUB-MRNMR-KT-10	LUB-MRNMR-KT-20	4	Mid Range Kit: 5 quarts of oil, oil filter, and drain screw gasket.
14~	F175	4.8 Qts.		LUB-MRNMR-KT-10	LUB-MRNMR-KT-20		
13~	VF150	4.8 Qts.		LUB-MRNMR-KT-10	LUB-MRNMR-KT-20		
'04~	F150	4.8 Qts.		LUB-MRNMR-KT-10	LUB-MRNMR-KT-20		
'15~	VF115	3.4 Qts.		LUB-MRNMD-KT-11	LUB-MRNMD-KT-21	4	Medium Kit: 4 quarts of oil, oil filter, and drain screw gasket
'15~	F115	3.4 Qts.		LUB-MRNMD-KT-11	LUB-MRNMD-KT-21		
'00~'14	F115	3.9 Qts.		LUB-MRNMD-KT-11	LUB-MRNMD-KT-21		
'99-'02	F100	5.0 Qts.		LUB-MRNMD-KT-11	LUB-MRNMD-KT-21		
'03~	F90	3.4 Qts.		LUB-MRNMD-KT-11	LUB-MRNMD-KT-21		
'99-'02	F80	5.0 Qts.		LUB-MRNMD-KT-11	LUB-MRNMD-KT-21		
'03~	F75	3.4 Qts.		LUB-MRNMD-KT-11	LUB-MRNMD-KT-21		
'10~	F70	2.3 Qts.		LUB-MRNSM-KT-10	LUB-MRNSM-KT-20		
'03~	T60	2.3 Qts.		LUB-MRNSM-KT-10	LUB-MRNSM-KT-20	6	Small Kit: 3 quarts of oil, oil filter, and drain screw Gasket
'02~	F60	2.3 Qts.		LUB-MRNSM-KT-10	LUB-MRNSM-KT-20		
'96~	T50	2.3 Qts.		LUB-MRNSM-KT-10	LUB-MRNSM-KT-20		
'95~	F50	2.3 Qts.		LUB-MRNSM-KT-10	LUB-MRNSM-KT-20		
'09~	F40A	2.1 Qts.		LUB-MRNSM-KT-10	LUB-MRNSM-KT-20		
'99-'08	F40	2.3 Qts.		LUB-MRNSM-KT-10	LUB-MRNSM-KT-20		
'01-'06	F30	2.3 Qts.		LUB-MRNSM-KT-10	LUB-MRNSM-KT-20		

Pumps and Spouts

Multi-Purpose Gallon Pump

Universal style gallon-size container pump. Fits standard oil containers with a 1-1/2" neck. A marine lower unit fitting and all-purpose fitting are also included.

ACC-PUMP0-02-GL



Multi-Purpose Quart Pump

Universal style quart-size container pump. Fits standard oil containers with a 1-1/8" neck. A marine lower unit fitting and all-purpose fitting are also included.

ACC-PUMP0-00-QT



5-Gallon Pail Pump

Use with 5-gallon pails of lube. Comes with special marine lower unit fitting and an all-purpose fitting for filling gearcases.

LUB-PUMP0-05-GL



Manual 55-Gallon Drum Pump

Use with 55-gallon drums of Yamalube.

ACC-11000-39-99



Oil Extractor Pump

Make changing the oil on your four stroke personal watercraft, snowmobile, ATV, boat, lawn mower, etc. clean and hassle free. Holds up to 6 liters (1.5 gal) in this sturdy portable container. Pump included.

SBT-OILEX-TR-CT



General Information

Rigging Estimate Guide (Diagrams)

Rigging Components

Electrical Components

Engine Accessories

Propellers

Maintenance Items

Oils & Lubes

Detailing & Trailer Supplies

Accessories & Apparel

Generators & Accessories



15 Liter Oil Extractor

This extractor is designed to extract fluids from inaccessible or confined areas. It is ideal for oil changes. To measure how much you have extracted, each calibrated line on the wall is about one liter with a total capacity of 15 liters.

SBT-15LEX-TR-10



Ratio Rite®

Provides measures for 16:1- 50:1 mixtures, and cc./oz./pt. for fills.

ABA-RATIO-RI-TE



Disposable Funnel

This paper funnel is great as either a shop tool or as an accessory to an oil change kit.

ACC-FLDFU-NN-EL

Fuel Additives

What's Good for the Environment Can Be Bad for Your Engine.

Ethanol-enriched (E-10) fuels help to improve air quality, which is why the federal government has mandated their increased use. However, unlike fuels of the past, E-10 fuels are known to absorb moisture, either from the air or from standing water in the bottoms of fuel tanks. They also generate corrosive sulfate salts that can attack metal components in a fuel system, clogging filters and resulting in other performance issues. Because of these known weaknesses, E-10 fuels require special care and treatment, whether your engine is in constant use or in storage. The Yamalube Care Products line includes formulations that help combat the potential harmful side-effects of E-10 fuels, ensuring high performance, lower ownership costs and a long life for your Yamaha.



Ring Free PLUS

Exclusive, synthetic PLUS formula provides superior deposit control; cleaning fuel injectors, carburetors, intake valves, intake ports and combustion chambers. Contains metal filmers to help protect fuel system components like silver solder, copper, aluminum and steel from the corrosive effects of ethanol sulfate salt.

- 32 oz. Bottle (Qty. 6*) ACC-RNGFR-PL-32**
- 12 oz. Bottle (Qty. 12*) ACC-RNGFR-PL-12**



Fuel Stabilizer & Conditioner PLUS

Strongly recommended for E-10 fuels, this alcohol-free formula helps prevent fuel oxidation and phase separation. Use continuously to help keep fuel fresh, potent and free from gum and varnish for up to one year of storage. Its metal filmers provide extensive protection for steel and aluminum components.

- 32 oz. Bottle (Qty. 6*) ACC-FSTAB-PL-32**
- 12 oz. Bottle (Qty. 12*) ACC-FSTAB-PL-12**



** Ordered individually with a minimum order quantity*

General Information

Rigging Estimate Guide (Diagrams)

Rigging Components

Electrical Components

Engine Accessories

Propellers

Maintenance Items

Oils & Lubes

Detailing & Trailer Supplies

Accessories & Apparel

Generators & Accessories

Grease



Molybdenum Disulfide

This extreme-pressure grease lubricates high loads at various speeds. Non-corrosive, it's water-resistant, exhibiting low-friction properties that protect against wear and galling in difficult operating conditions.

10 oz. Tube (Qty. 12*) ACC-MOLDM-GS-10



Marine Grease

Especially formulated to resist wash-off and extreme heat and pressure, and prevent corrosion and rust. (NLGI® 2) Lithium soap based.

10 oz. Tube (Qty. 12*) ACC-GREAS-10-CT

14 oz. Cartridge (Qty. 10*) ACC-GREAS-14-CT



Multi-Purpose Grease

Specially formulated to resist extreme pressure, water and corrosion. (NLGI® 2)

1 lb. Tub (Qty. 6*) ACC-MLTPR-GR-00



WR No. 2 Grease

Provides water resistance, rust protection, lubrication and heat resistance. Specially designed for four stroke oil pump seals, drive shaft splines and drive shaft bushing area. For four stroke and two stroke applications.

90790-74046-00

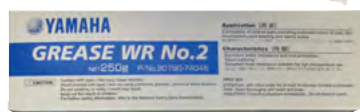

* Ordered individually with a minimum order quantity

Power Trim & Tilt

Premium formula is nonfoaming and resists heat and pressure found in power trim, tilt and power steering systems for smooth operation. Meets Yamaha factory requirements.

Quart Bottle (Qty. 12*) ACC-PWRTR-MF-32

10 oz. Tube (Qty. 12*) ACC-PWRTR-MF-10



Marine Lower Unit Gear Lube HD

Special formulation required for use in V8 F300-F350 V6 VMAX SHO® 200-250, and 4.2L Offshore gearcases. (Not recommended for use in any other Yamaha outboard.)

Quart Bottle (Qty. 12*) ACC-GLUBE-HD-QT

Gallon Bottles ACC-GLUBE-HD-GL

5 Gallon Pail ACC-GLUBE-HD-05



Gearcase Lube

Rust and corrosion inhibitors protect outboard gearcase components. (Not for use on V8 outboards.)

10 oz. Tube (Qty. 12*) **ACC-GEARL-UB-10**

Quart Bottle (Qty. 12*) **ACC-GEARL-UB-QT**

Gallon Bottle (Qty. 4*) **ACC-GEARL-UB-GL**

5 Gallon Pail **ACC-GEARL-UB-05**

55 Gallon Drum **ACC-GEARL-UB-55**



* Ordered individually with a minimum order quantity

- General Information
- Rigging Estimate Guide (Diagrams)
- Rigging Components
- Electrical Components
- Engine Accessories
- Propellers
- Maintenance Items
- Oils & Lubes**
- Detailing & Trailer Supplies
- Accessories & Apparel
- Generators & Accessories

Yamabond® Adhesives



Yamabond® 4 Marine

This silicone-based liquid gasket fills gaps to prevent leaks. Pressure and oil resistant.

3 oz. Tube **ACC-BOND4-MA-00**



Yamabond® 5

Coat mechanical joints with this liquid gasket before assembly to prevent leaks.

2.5 oz. Tube **ACC-YAMAB-ON-D5**



Yamabond® 6B

Has high viscosity and excellent swelling, and works effectively for joint surfaces that have a larger clearance.

3.5 oz. Tube **ACC-YAMAB-ND-6B**



Yamabond® 7

High-strength, synthetic rubber adhesive formulated for grips, throttle pipes and lever handles, without damaging rubber.

10 gram Tube **ACC-YAMAB-ON-D7**



Yamabond® 1386

Used for camshaft caps on four stroke outboard engines.

15 ml Bottle **ACC-YAMBD-13-86**

Threadlock



Yamabond® Blue Threadlocker

This medium-strength anaerobic threadlocking agent prevents nuts and bolts from loosening due to vibration. This primerless threadlocker is easy to use. Can be used where service manual calls for Loctite® 242™.

ACC-YAMBD-P2-42



Yamabond® Red Threadlocker

This high-strength anaerobic threadlocking agent prevents nuts and bolts from loosening. This primerless threadlocker is easy to use. This product is for use where the service manual states "Use LT 271."

ACC-YAMBD-P2-71

Shop Supplies



Yamaha Internal Engine Cleaner
For dealer purchase only. The best product offered by Yamaha for carbon removal. Ordered by case, 1 on order equals 6 bottles.

Quart bottle (Qty. 6*)
ACC-CLEAN-D1-00



Carburetor Cleaner Dip
Use this concentrated solution with water as a dip for cleaning metal that has been varnished by old gasoline. Also removes dirt, grime and gum.

Quart Bottle (Qty. 12*)
ACC-CARBC-LE-NR



EFI Engine Storage Fogging Oil
Equally distributes fogging oil to cylinders in EFI engines with single-throttle bodies, protecting pistons, cylinder walls and valves from moisture, salt water and combustion acids for up to 1 year of storage.

Quart Bottle (Qty. 6*)
ACC-STORR-IT-32



Stor-Rite Engine Fogging Oil
Lubricates and protects internal engine components. Critical for proper winterization and during extended storage periods.

12 oz. Can (Qty. 12*)
ACC-STORE-RI-TE



Combustion Chamber Cleaner
Use to remove carbon and other contaminants from cylinders, pistons, rings and valves. A great inclusion into your seasonal maintenance. Clean engines last longer.

13 oz. Can (Qty. 12*)
ACC-CMBSN-CL-NR



LubezAll
This popular lube is back and completely reformulated. Now an aerosol synthetic grease with PTBE, it's a high quality multipurpose lubricant.

11 oz. Can (Qty. 12*)
ACC-LUBZA-LL-00



Brake & Contact Cleaner
Use this product to clean off brake dust from critical brake components and quickly clean parts leaving them residue free.

13 oz. Can (Qty. 12*)
ACC-BRKCT-12-00



Battery Terminal Cleaner & Protector
This strong water-based cleaner with acid-alkali indicator removes corrosive build-up on battery terminal posts to help increase power output and extend battery life. Simply rinses off with water and leaves terminals coated with a residual protective film.

13 oz. Can (Qty. 12*)
ACC-BATTCLN-PR

* Ordered individually with a minimum order quantity

General Information
Rigging Estimate Guide (Diagrams)
Rigging Components
Electrical Components
Engine Accessories
Propellers
Maintenance Items
Oils & Lubes
Detailing & Trailer Supplies
Accessories & Apparel
Generators & Accessories



External Engine Cleaner

Powerful engine degreaser and engine cleaner powers off grease, mud and grime. Safe on most rubber, plastic and painted metal surfaces.

15 oz. Can (Qty. 12*)
ACC-ENGCL-NR-00



Yamashield™

Designed to create a non-conductive shield on surfaces that are exposed to the elements. This shield will reduce the effects of moisture on metal components and electrical connections. (Replaces Boeshield T-9® Protectant and Lubricant ACC-T9SPR-AY-00)

13 oz. Can (Qty. 12*)
ACC-YAMSH-LD-00



Precision Parts Cleaner

Designed to meet all the demands of a fast-drying, powerful cleaner. Formulated to remove oil, grease, and other contaminants. Quickly and easily cleans engine parts, internal and external components, ignitions, electrical components, spark plugs, or any use where a fast-drying cleaner that leaves no residue is needed.

12.5 oz. Can (Qty. 12*)
ACC-PPCPT-CL-NR



Silicone Spray Protectant & Lubricant

General-purpose lubricant that helps to protect metals against rust and corrosion. Conditions and protects neoprene, rubber and other surfaces from environmental effects.

11 oz. Can (Qty. 12*)
ACC-SLCNS-PR-AY



Hand Cleaner

This hand cleaner powers through dirt, grease, and grime to give your hands a smooth clean feeling. Also available in a one-gallon bottle, for use with our wall mounted dispenser.

15 oz. (Qty. 12*)

ACC-HNDCL-NR-00

4 liters (Qty. 4*)

ACC-HNDCL-NR-01

Dispenser

ACC-HNDCL-NR-DS



Carburetor and Choke Cleaner

A combination of powerful solvents designed to remove gum, varnish, carbon and other contaminants. This unique formula cleans internal and external carburetor components including jets, venturi, tubes, intake valves, linkages and carburetor bodies. Extra-heavy propellant creates a powerful charged spray for hard to reach areas.

12.5 oz. Can (Qty. 12*)
ACC-CARBS-PR-AY

* Ordered individually with a minimum order quantity

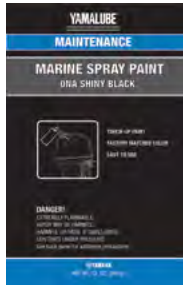

Marine Spray Paint by Yamalube

A high-quality, factory-matched spray paint for touch-ups or full overcoat application. This durable enamel coating will provide good performance in the rigors of the marine environment.

- 8D Dark Bluish Gray 1 **ACC-MRNPA-IT-8D**
- 4D Dark Bluish Gray Metallic 2 **ACC-MRNPA-IT-4D**
- NA Shiny Black **ACC-MRNPA-IT-NA**

Nitrile Disposable Mechanics Gloves

These black nitrile gloves are textured to enhance grip action and are up to three to four times the puncture and chemical resistance of latex. Powder free Latex-free 100 gloves per box

- Medium - **ACC-MECHG-LV-MD**
- Large - **ACC-MECHG-LV-LG**
- X Large - **ACC-MECHG-LV-XL**



For the Technician

Metric Tool Kit

This handy metric tool kit contains the following: combo wrenches (8, 10, 12 and 14mm), 8" adjustable wrench, locking wrench, 4-way Phillips/standard screw driver, Allen wrenches (#3, #4, #5 and #6), spark plug wrench, spark plug gap gauge, black electrical tape, WD-40®, tire pressure gauge, zip ties, wire, rag and a handy zippered storage case.

ABA-METRC-00-00



General Information

Rigging Estimate Guide (Diagrams)

Rigging Components

Electrical Components

Engine Accessories

Propellers

Maintenance Items

Oils & Lubes

Detailing & Trailer Supplies

Accessories & Apparel

Generators & Accessories



PowerDrive™ Sliding T-Driver with 8-Piece Socket Set by CruzTOOLS®

The PowerDrive™ Sliding T-handle set Includes a 3/8" tip driver, 8, 10, 12, 14, and 17mm sockets, 5 and 6mm hex bits and a #2 Phillips screwdriver bit. A socket clip that attaches to the driver keeps the sockets in order and a rugged vinyl pouch keeps the tools protected.

ACC-0SS58-40-67



T-Handle Allen Set

Allen T-handle set comes with 2.5, 3, 4, 5, and 6mm sizes. Also comes with a vinyl carrying pouch.

ABA-THNDL-AL-ST

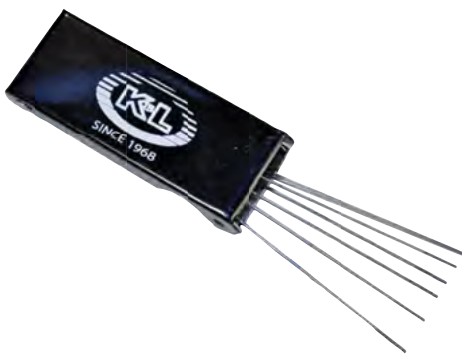

Jet Cleaning Tool

These precisely machined rods are sized to allow you to clean out carburetor jets without causing damage. A very handy tool for regular carburetor maintenance.

MTS-TLSKT-04-03



Oil Filter Wrench

This stamped steel, chrome plated filter wrench makes removing oil filters a breeze. Simply place the wrench over the end of the filter and turn it using either a 3/8" ratchet or 17mm wrench. Two sizes will cover all of your Yamaha spin-on style filters. For 3FV and 5GH Yamaha Oil Filters.

MTS-TLSKT-02-09

Yamaha Diagnostic System



Part Number	Description	Qty.
90890-06884-00	YDIS 2 Hardware Kit	1
Individual Replacement Kit Components		
6DE-8533A-10-99	K-Line Harness (motor to adapter)	1
6DE-8533A-20-99	CAN Harness (CL hub to adapter)	1
6DE-8533A-30-99	AD Harness (external inputs to adapter)	1
6DE-8533A-40-99	Trigger Switch	1
6DE-8533A-50-99	Extension Harness (trigger switch)	1
6DE-8533A-60-99	12V Power Supply Harness	1
6DE-82582-00-99	AD Connector Cap (adapter)	1
90890-06899-00	VPP Harness	1
90890-05160-00	Female Bullet Connector	6
6DE-85335-00-99	Adapter Module (data logger)	1
See Note 1	Type A/B USB Cable	1
Optional Equipment		
6DE-8533A-70-99	K-Line Extension Harness 16' (5m)	1
90890-06900-00	Command Link/Command Link Plus DEC Checker Harness Kit	1
90890-06886-00	Signal Tester Kit	1

Note1: One A/B type USB cable, to connect the adapter module to a USB port on a laptop computer, is supplied with the hardware kit. Replacement A/B (printer) type USB cable, in various lengths, can be purchased from local sources.

YDIS Smart

The YDIS Smart adapter uses Bluetooth® technology to establish wireless communication between compatible Yamaha outboards and your smartphone, via the K-Line on the engine. The new mobile application provides quick access to essential menus necessary for accurate troubleshooting. The YDIS Smart application is available on the App Store for Apple® iOS and Google Play™ for Android® operating systems. A previously purchased YDIS 2.2 PC version installation key is required to install the app.



LIT-YDISM-AR-T0



Description	Page
Cleaning Chemicals	9-1
Tire Repair and Supplies	9-2
Locks and Security	9-3
Trailer Repair Supplies	9-4
Tie Downs and Straps	9-5

General
Information

Rigging Estimate
Guide (Diagrams)

Rigging
Components

Electrical
Components

Engine
Accessories

Propellers

Maintenance
Items

Oils
& Lubes

**Detailing &
Trailer Supplies**

Accessories
& Apparel

Generators
& Accessories

Cleaning Chemicals



Spray Polish

This quick detailer will restore a lustrous shine to paint, chrome, glass and smooth plastics like visors, windshields, and gauges. Gives textured plastics, rubber and vinyl a beautiful satin finish. Anti-static properties repel dust and dirt to keep that shine.

14 oz. Can (Qty. 12*) **ACC-SPRAY-PL-SH**



Yamaclean® Pro-Wash Spray

Yamaclean® Pro-Wash Spray is a biodegradable vehicle spray wash that removes grime and soil. Rinses clean and helps keep your boat looking new.

32 oz. Bottle (Qty. 12*) **ACC-YAMAC-PW-SP**



Yamaclean® Vinyl Dressing

This one-step formula restores and protects vinyl, rubber, plastics and leather. When dry, it leaves a transparent and water repellent gloss coating that isn't slippery. Its UV protection also helps to prevent drying and cracking.

32 oz. Bottle (Qty. 12*) **ACC-YAMAC-VN-DR**



Yamaclean® Pro-Wash Spray Concentrate

Special concentrated formula for use in pressure washer soap tanks. A biodegradable vehicle wash that removes grime and soil. Rinses clean and helps keep your vehicle looking new. Safe for use on most surfaces when used as directed.

1 Gallon Bottle (Qty. 4*) **ACC-YAMAC-PW-GL**



Yamacoat™

A high-quality plastic coating. Helps maintain the color and surface finish of plastic for that "factory" look. Use an even spray on components to be treated. Once spray is applied, wipe off with a clean, dry cloth. Can also be left wet to help inhibit adhesion of mud and dirt to make cleanup easier.

10 oz. Can (Qty. 12*) **ACC-YAMAC-OA-TC**

* Ordered individually with a minimum order quantity



Yamalube GLARE® Professional Polish
Ultra-high gloss, penetrating sealant with Glassplexin®. Protects your vehicle's finish and reduces damage caused by road tar, road salt, salt air, eggs, bugs, bird droppings, tree sap, glue, ink, spray paint, acid rain, fall out, detergents, abrasions, and more. Blocks harmful UV sun rays (UVA/UVB). For use on paint, chrome, carbon fiber, plastic, glass, fiberglass, aluminum, stainless steel, mirrors, and Plexiglas®.

ACC-YAMAG-LA-RE

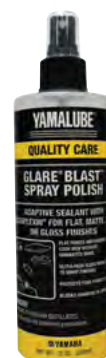

GLARE® Blast™ Spray Polish
GLARE® Blast™ Spray Polish is the all-encompassing spray detailer polish you have been looking for. Contains Camo-Adaptive Glassplexin™ that makes gloss surfaces pop with brilliance and flat or matte surfaces look brand new without unwanted shine. For use on gloss paint, flat paint, chrome, carbon fiber, plastic, glass, fiberglass, metals of all types, plastic, rubber, leather, vinyl, and Plexiglas®

12 oz. Bottle (Qty. 6*) **ACC-YAMAB-LA-ST**

Tire Repair and Supplies



TirePro™ Dial Tire Gauge by CruzTOOLS®
The TirePro™ gauge has a 12" flexible hose that makes even hard-to-get-to valves less of a task. Readings are held until released, and a built-in valve lets you bleed air to the desired pressure. The dial is protected by a rubber boot and readings are in both psi and kPa.

ACC-OSS58-40-69



Low Pressure Tire Gauge
The Low Pressure Tire Gauge indicates air pressure up to 15 psi in 1/4 lb. increments with range to 15 psi. The tire gauge features includes swivel angel chuck and sturdy construction.

ACC-11130-00-31

* Ordered individually with a minimum order quantity

General Information

Rigging Estimate Guide (Diagrams)

Rigging Components

Electrical Components

Engine Accessories

Propellers

Maintenance Items

Oils & Lubes

Detailing & Trailer Supplies

Accessories & Apparel

Generators & Accessories



Tire Mount Lube

Specially formulated lubricant that allows you to change tires on the rim quickly with less chance of damage. Use on any rim-mounted tire to provide a lubricated surface that eases tire installation while helping to protect the tire bead from damage. Preventing damage to the tire bead improves its sealing ability.

16 oz. Can (Qty. 12*) **ACC-TIREM-TL-UB**



Tubeless Tire Repair Kit

Includes plugs, tools, four CO2 air-pumping cartridges and a storage case.

ABB-ATVTR-RP-KT

Locks and Security



McGard® Wheel Locks

McGard®'s easy to use, one-piece wheel lock functions like a regular lug nut, but requires a special key tool for installation and removal. Its design allows for an unlimited number of different computer generated lock and key patterns. This unique wheel lock system is continually being refined and improved upon. McGard® Locks are made right here in the United States to meet or exceed O.E.M. standards for safety and durability

Single Axle Trailer (2 locking nuts): **MAR-TRLK7-40-42**

Dual Axle Trailer (4 locking nuts): **MAR-TRLK7-40-41**

* Ordered individually with a minimum order quantity

Trailer Repair Supplies

Brake Fluid

This high-quality hydraulic brake fluid meets DOT 4 specifications and is the only brake fluid currently recommended for use in Yamaha products.

8 oz. Bottle

(Qty. 12*) **ACC-BRAKE-FL-UD**



3300 Lb. Hand Winch Strap

Marine winch strap with forged snap closure hook . Sewn loop for bolt placement in winching system. Strong 2"-wide black polyester webbing.

2" x 25' **SBT-BOWST-RP-11**



Spare Tire Carrier

Zinc plated. Clamps to the trailer frame with no drilling. Uses same size lug nuts as stock trailer lug nuts. All necessary mounting hardware included. Fits all standard boat trailers.

SBT-SPARE-TC-08



** Ordered individually with a minimum order quantity*

Tie Downs and Straps



Yamaha Deluxe 2-Foot Transom Ties

Quality transom tie downs with an attractive price. Similar to what is supplied from the factory on Yamaha boats, these transom ties are made of 2" wide, weather-resistant polypropylene webbing with heavy-gauge, zinc-plated hardware and rubber coated "J" hooks to protect the transom of your boat. Oversized handle makes for easy locking and unlocking. Sewn-on hook-and-loop fasteners help secure the loose end of the strapping. Excellent for securing your Boat to the trailer at an affordable price. Sold in pairs.

SBT-TRNSM-TD-08



Yamaha Cam Buckle Tie Downs

1" x 6' tie downs with 1" cam lock buckle. Straps are rated for 400 lb. working and 1200 lb. break strength. (Sold in pairs.)

Black **ACC-0SS58-40-27**

Blue **ACC-0SS58-40-28**



Yamaha Ratcheting Tie Downs

1" x 6' tie downs with 1" rubber handle ratchet. Straps are rated for 400 lb. working and 1200 lb. break strength. (Sold in pairs.)

Black **ACC-0SS58-40-29**

Blue **ACC-0SS58-40-30**



Heavy-Duty Re-Tractable Ratcheting Tie Downs

1"-wide tie down is rated at 1500 lb. with a WLL (Work Load Limit) of 500 lb. and the 2"-wide model is rated at 4000 lb. with a WLL of 1333 lb. (Sold in pairs.)

1" Wide **ACC-0SS58-40-17**

2" Wide **ACC-0SS58-40-18**



Description	Page
Anchors	10-1
Fenders	10-4
Ropes and Dock Lines	10-6
Stand-Up Paddleboards & Kayaks	10-11
Tubes	10-15
Boards, Skies and Loungers	10-16
Inflatable Pumps and Valves	10-17
Audio Equipment	10-19
Battery Chargers and Battery Switches	10-22
Magma® Grills and Accessories	10-24
Coolers	10-25
General Boating Accessories and Upgrades	10-26
Personal Floatation Devices	10-30
Hats and Visors	10-34
Apparel & Gifts	10-37
Yamaha Seascooter	10-47
Body Glove®	10-48

General
Information

Rigging Estimate
Guide (Diagrams)

Rigging
Components

Electrical
Components

Engine
Accessories

Propellers

Maintenance
Items

Oils
& Lubes

Detailing &
Trailer Supplies

**Accessories
& Apparel**

Generators
& Accessories

Anchors



Boat Sand Stake Kit

If you would like to anchor your Yamaha boat on a sandy beach, simply screw the stake into the sand, remove the handle, and attach the 25 feet of heavy-duty rope. A storage bag is also provided.

MAR-SANDS-TK-KT



Yamaha Heavy-Duty Boat Anchor Kit

This anchor kit is specifically designed with the larger boats in mind. This kit includes an 11-lb., vinyl-coated anchor and chain which helps prevent corrosion as well as scratched hulls. A 100-foot rope with a snap hook is included along with a convenient storage bag.

MAR-ANCHR-KT-00



Complete Folding Grapnel Anchor Kit

This complete anchor system is in a class by itself. The 3-1/3 pound 4-fluke folding anchor will hold in mud, sand, gravel, and rock. It's designed for temporary mooring of small boats, sailboats, personal watercraft, inflatable boats, canoes, and float tubes. The anchor is coated to protect finishes. The durable nylon storage case is padded for added protection and to dampen noise while the anchor is stowed. Fits under most boat seats. The 25 ft. long marine-grade rope, with an in-line buoy, is spliced to the anchor and a heavy-duty stainless steel snap hook.

VDF-A7452-63-17



Mushroom Anchor

This 8-lb. mushroom anchor comes with 15 feet of nylon rope, a high visibility plastic float, and a plastic clip. This setup is perfect for anchoring in shallow water.

MAR-ANCHR-MR-08

PWC Anchor

This anchor is designed for those needing an anchor without the hassles of carrying large heavy ones. This anchor attaches easily and is designed to be hand set. Includes 15 feet of heavy-duty line. Stores in its own handy bag.

MWV-ANCHR-WR-00



Beach Stake

The beach stake is a perfect way to keep your PWC tied to the shore. Screw the stake into the ground, and you have 15 feet of line to tether your PWC. It is easy to store and take along.

MWV-BEACH-AN-CR



PWC Sand Stake Kit

If you would like to anchor your PWC on a sandy beach, this is the easiest and most convenient way. Simply screw the stake into the sand, remove the handle, and attach the 15 feet of heavy-duty line. A storage bag is also provided.

MWV-SANDS-TK-KT



Boat Anchor Kit

This Yamaha Boat Anchor designed specifically to fit the anchor storage of your boat. Kit includes a galvanized 10-Danforth® style anchor a 6-foot chain shackled 100 feet of standard nylon rope that's sinkable for convenient setting.

SBT-ANCHR-KT-08



General Information

Rigging Estimate Guide (Diagrams)

Rigging Components

Electrical Components

Engine Accessories

Propellers

Maintenance Items

Oils & Lubes

Detailing & Trailer Supplies

Accessories & Apparel

Generators & Accessories



Soft-Style Anchor

Popular, easy-to-use anchor bag system. Simply fill the anchor bag with heavy objects such as rocks or sand and close with the plastic, noncorrosive zipper. Includes a 10 foot polypropylene rope and a sturdy float and snap. Easy to store when not in use.

MWV-ANCHR-BG-00



Tri-Fluke Anchor

The tri-fluke design of this river anchor allows the flukes to penetrate the river bottom in soft and moderate conditions, to engage rocks and structure in rivers and current. The river anchor is a great all-purpose anchor for lighter craft, or a great second anchor. Weight: 20lb

Black **SBT-520BK-20-12**

Red **SBT-520RD-20-12**

Blue **SBT-520BL-20-12**



Richter™ Self Releasing Anchor

Performance in rocks, mud, weeds, and sand is superior to traditional anchors and requires less anchor line. Weight: 18lb

SBT-618B2-18-12

Fenders

Yamaha 24-Inch Boat Contour Fender

These contour fenders stay put and stow conveniently under boat seats. They hinge to wrap around the gunwale and hull, following the contours of the boat. Constructed of a durable marine grade tri-laminate cover, with closed cell foam inside. There's a tough polycarbonate grommet at each end for hanging from cleats. (Sold Individually. 24" long x 6" wide x 2-1/2" thick)

Blue **MAR-HHFND-ER-BL**
 Black **MAR-HHFND-ER-BK**



No-Slip™ Fender Straps

No more tying and untying knots! Attach boat fenders to rails and cleats quickly and securely with these fender straps. The No-Slip™ pads sewn to the underside of the straps minimize sliding along rails. Easily adjust the length in seconds from 6 inches to 40 inches to fit most boats and docking situations.

(Set of 2.) **MAR-FNDRS-TR-AP**



Suction Cup Fender Straps

Great for Boats and Personal Watercraft. Attach your boat fenders exactly where you need the protection. Giant 3-1/4" suction cups attach to gelcoat or windshields quickly and easily. Perfect for most boats and personal watercraft where cleats never seem to be where you need them. Durable 1" wide straps adjust up to 24" long. Fenders not included.

(Set of 2.) **SBT-SF1C0-00-10**



General Information

Rigging Estimate Guide (Diagrams)

Rigging Components

Electrical Components

Engine Accessories

Propellers

Maintenance Items

Oils & Lubes

Detailing & Trailer Supplies

Accessories & Apparel

Generators & Accessories



Yamaha Fenders

These high-quality fenders help to protect the boat when secured to the dock or another boat. These come equipped with four feet of rope. (Sold individually.)

- 16" White **MAR-FENDR-WH-16**
- 16" Blue **MAR-FENDR-00-16**
- 20" White **MAR-FENDR-WH-20**
- 20" Blue **MAR-FENDR-00-20**
- 23" White **MAR-FENDR-WH-23**



Hull Huger™ Contour Fender

Traditional round fenders tend to roll up, leaving your boat unprotected. They're also bulky to stow. Boats with step down gunwales are especially vulnerable to damage from docks. HULL HUGR™ Contour Fenders stay put and stow conveniently under boat seats. They hinge to wrap around the gunwale and hull, following the contours of the boat. All HULL HUGR™s are constructed of a durable marine grade tri-laminate cover, with closed cell foam inside. There's a tough polycarbonate grommet at each end for hanging from cleats. (Sold Individually.) 24" long x 6" wide x 2 1/2" thick

- Blue **VDF-HHL60-72-17**
- White **VDF-HH1W8-02-17**
- Black **VDF-HH1CB-00-17**



Hull Huger™ XI Contour Fenders

Traditional round fenders tend to roll up from contact with docks, leaving your boat unprotected. They're also bulky to stow. Boats with step down gunwales are especially vulnerable to damage from docks. HULL HUGR™ Contour Fenders stay put and stow conveniently under boat seats. They hinge to wrap around the gunwale and hull, following the contours of the boat. All HULL HUGR™s are constructed with a tough marine grade rip proof trilaminate cover, with closed cell foam inside. Durable polycarbonate grommets at each end allow you to hang them from cleats. (Sold Individually.) (30" long x 6" wide x 4" thick)

- Blue **VDF-HH30C-00-17**
- White **VDF-HH30C-B0-17**
- Black **VDF-HH30C-W0-17**

Ropes and Dock Line

Dock Lines

These dock lines are made of multi-filament, solid braid polypropylene. Floats if accidentally dropped in water and resists salt water, oil, gas, UV rays, and mildew. (Sold individually.)

	12 Foot 3/8 in. Diameter	15 Foot 3/8 in. Diameter	20 Foot 1/2 in. Diameter
Yamaha Branded			
White	MWV-DLINE-12-WH	SBT-DLINE-15-WH	SBT-DLINE-20-WH
Silver		SBT-DLINE-15-SL	SBT-DLINE-20-SL
Black	MWV-DLINE-12-BK	SBT-DLINE-15-BK	SBT-DLINE-20-BK
Red	MWV-DLINE-12-RD	SBT-DLINE-15-RD	SBT-DLINE-20-RD
Blue	MWV-DLINE-12-BL	SBT-DLINE-15-BL	SBT-DLINE-20-BL
Non-Branded			
White	SBT-DLM-3815-WO	SBT-DLM-1220-WO	
Silver	SBT-DLM-3815-SO	SBT-DLM-1220-SR	
Black	SBT-DLM-3815-BK	SBT-DLM-1220-BK	
Red	SBT-DLM-3815-RD		
Blue	SBT-DLM-3815-BL	SBT-DLM-1220-BL	

Greenfield Stretch N' Slide® Multi-Loop Versatile Dock Line

Without question, Stretch N' Slide® is the world's most versatile and easy to use dock line. Innovative multi-loop bungee allows a perfect fit for any span to 7'. Simply place the end loop over a cleat, then stretch and tighten down the slider, and, finally, select the appropriate loop to place over the second cleat. Stretch N' Slide® makes docking quick and easy for any craft from PWC to large boats. Stretch N' Slide® is also the ultimate solution for rafting boats together for a party chain. Shock-absorbing bungee allows an entire chain of boats to move and flex together with ease. Temporary docking only.

SBT-SNSLN-00-12



Airhead® Bungee Dock Lines

AIRHEAD® Bungee Dock Lines absorb shock to boats, cleats, docks, pylons and other hardware. The bungee cord is hidden inside the rope and acts as a built in snubber. Two foam floats help protect the boat from chafing. There's a sliding adjustment at both ends for quick docking. Recommended for docking boats up to 4000 pounds. Tensile strength is 2150 pounds. Black/Blue/Red color scheme. (Sold Individually.)

4 ft., stretches to 5 1/2 ft. **VDF-AHDL4-00-17**

5 ft., stretches to 7 ft. **VDF-AHDL5-82-17**

6 ft., stretches to 9 ft. **VDF-AHDL6-00-17**



General Information

Rigging Estimate Guide (Diagrams)

Rigging Components

Electrical Components

Engine Accessories

Propellers

Maintenance Items

Oils & Lubes

Detailing & Trailer Supplies

Accessories & Apparel

Generators & Accessories



Fender Line
5 feet long, Blue.

MAR-FENDR-LN-BL



3~4 Rider Tube Tow Rope

This 4-rider tube tow rope has 2 sections, giving you the option to tow either 50 or 60 feet behind the boat depending on wake and water conditions. The pre-stretched UV-resistant 5/8" diameter 16-strand rope exceeds the 4150 pound break strength required by the WSIA for 4-rider tubes. A 6" foam float is provided for extra buoyancy. A rope keeper is included for convenient storage.

SBT-TUBER-P0-07



Airhead® 75 Ft. 1-Section Ski Rope

A high quality 1 section ski rope for skiing, wakeboarding and kneeboarding. The 12" aluminum core handle has a performance "Tractor" grip and molded finger protectors. You'll love the blue and white candy stripe color scheme of the UV treated 16-strand rope. A rope keeper is included for tangle-free storage.

VDF-AHSR7-50-17



Airhead® Kwik-Connect™ Tow Rope Connector

Conveniently attach and detach tube tow ropes to towables with Airhead's® Kwik-Connect™. There's no need to thread 60 feet of rope through the tow strap each time you connect or disconnect a tow rope. The high-impact Kwik-Connect™ has a 1-inch diameter hole to accept up to 6000 lb. break strength tube ropes. Recommended for 1- to 4-rider towables that are not equipped with Kwik-Connect™.

VDF-AHKC1-00-17

Emergency Tow Line

Tow line consists of a 15-foot long tow line with a nylon quick connect at each end that allows fast, easy hook-ups. For slow-speed emergency towing only.

MWV-TOWLI-NE-15



Yamaha Rope Float

This rope float can be used to create a custom rope to suit your own personal needs.

(Sold individually.) **MAR-ROPEF-LO-AT**



Ski Rope Floats

Developed to help keep ski ropes away from the propeller on your boat or to help prevent them from being ingested by the pump. Run your ski rope through the middle of the nylon-covered, closed-cell foam tube before attaching to the tow eye. Yamaha logo silk-screened on one side.

48" Black **MAR-RPFLT-BK-48**

48" Blue **MAR-RPFLT-BL-48**

24" Black **MAR-RPFLT-BK-24**

24" Blue **MAR-RPFLT-BL-24**



Yamaha 4-Section Performance Water Ski Rope

This 75-foot long rope has four sections (40', 10', 10', 15') to meet the needs of skiers and riders of all skill levels. The 13" aluminum core handle has a performance EVA "amoeba" grip and full-length molded finger protectors. Top quality UV-treated 16-strand 1600 lb. tensile strength rope. A Rope Keeper is included for tangle-free storage.

SBT-SKRP0-00-07



General Information

Rigging Estimate Guide (Diagrams)

Rigging Components

Electrical Components

Engine Accessories

Propellers

Maintenance Items

Oils & Lubes

Detailing & Trailer Supplies

Accessories & Apparel

Generators & Accessories



Airhead® Wakeboard Rope

This wakeboard rope has a head-turning 15" squid patterned EVA-wrapped grip with a floating aluminum core. The 5/16", 16-strand, UV treated low stretch buoyant rope has three sections for wakeboarding at 45', 55', or 65' (45', 10', 10'). Full length finger guards help create a comfortable split finger grip. A rope keeper is included for tangle-free storage.

VDF-30010-AH-17



1~2 Rider Tube Tow Rope

This tube tow rope has two sections, giving you the option to be either 50 or 60 feet behind the boat depending on wake and water conditions. The prestretched, UV-resistant 7/16" diameter 16-strand rope exceeds the 2375 lb. break strength required by the WSIA for 2-rider tubes. A rope keeper is included for convenient storage.

Blue **MAR-TUBER-OP-06**

Red **SBT-TUBER-OP-10**



Airhead® 2 Rider 2-Section Tube Rope

This tube tow rope has 2 sections, giving the option to tow the tube either 50 or 60 feet behind the boat depending on wake and water conditions. The prestretched UV-resistant 7/16 inch diameter 16-strand rope exceeds the 2375 pound break strength required by the WSIA for 2-rider tubes. A rope keeper is included for convenient storage.

VDF-AHTR2-20-17

Airhead® Deluxe 4- Rider Tube Tow Rope

This heavy-duty 16-strand 9/16 inch x 60 foot tube tow rope is rated at 4150 pounds tensile strength! Engineered to pull the big 3 and 4-rider tubes, this rope will stand the test of time. It has a unique Rasta color scheme with a 6-inch loop spliced at each end. A rope keeper is included for tangle free storage.

VDF-AHTR4-00-17



Centering Tow Harness

This 3000-pound-tensile-strength tow harness is perfect for pulling skiers and wakeboarders, as well as 1- or 2-rider towables. A stainless steel pulley glides along the length of the rope to provide the optimum pull at all times. Simply clip it onto your boat with the 5000-pound-tensile-strength hooks provided, and attach your ski or tube rope to the heavy duty Kwik-Connect™. The 6" float keeps the Kwik-Connect™ floating. It's 12' long to fit pontoon and larger boats.

VDF-AHTR3-00-17



Airhead® Tow Demon™

Airhead's® Tow Demons™ are new higher strength versions of a classic and very popular water sports tow harness. The high impact molded plastic float/ pulley system allows for easy attachment of ski ropes, wakeboard ropes and tube ropes. Connect Tow Demon™ quickly and easily to boats with the 2 large corrosion-resistant snap hooks. Available in vinyl jacketed steel cable and floating rope versions. Recommended for recreational water skiing, wakeboarding, kneeboarding, and towing 1 rider tubes.

8 ft. cable **VDF-AHTR6-00-17**

12 ft. cable **VDF-AHTR7-00-17**



General Information

Rigging Estimate Guide (Diagrams)

Rigging Components

Electrical Components

Engine Accessories

Propellers

Maintenance Items

Oils & Lubes

Detailing & Trailer Supplies

Accessories & Apparel

Generators & Accessories

Stand-Up Paddleboards & Kayaks



SUP (Stand Up Paddleboard) Carbon Composite Paddle

The SUP Carbon Composite Paddle is the perfect companion to any paddleboards. Length adjusts from 160 to 210 cm. Stiff, lightweight carbon fiber composite shaft. Fiberglass-reinforced polymer “duck foot” blade.

VDF-AHSUP-P4-17



SUP Fiberglass Paddle

The SUP Fiberglass Paddle is a perfect companion to the Napali stand-up paddleboard. Easily adjustable from 160 to 210 cm. Weighs less than 2 lbs. 3 oz. 100% fiberglass shaft.

VDF-AHSUP-P1-17



2-in-1 Airhead SUP® / Kayak Paddle

AIRHEAD® 2 in 1 SUP/Kayak Paddle gives you the best of both worlds with its 2 in 1 design. This 3-section SUP / KAYAK paddle is an amazing dual performance paddle for your AIRHEAD® NaPali or other stand up paddleboard. Explore uncharted waters with the SUP Handle or connect the included Kayak Paddle section for a seated kayak style ride. The SUP handle length can easily be adjusted from 165 cm to 185 cm and the Kayak Paddle adjusts from 208 cm to 228 cm. The aluminum shafts and High Impact Plastic Blades are specifically designed for both SUP's and kayaks.

VDF-AHSUP-P3-17

Heavy-Duty Airhead SUP® Board Leash

The Heavy-Duty SUP Board Leash is lightweight and keeps you connected to your paddleboard while staying out of your way when paddling. Extends to 11'. Recommended for surf and lake use only.

VDF-AHSUP-A7-17



Scrunchy Airhead SUP® Board Leash

The Scrunchy SUP Board Leash features a lightweight accordion-style that keeps you connected to your paddleboard while staying out of your way when paddling. Stretches to 11'. Comfortable neoprene-lined ankle cuff.

VDF-AHSUP-A8-17



Airhead SUP® Paddle Rod Leash

The SUP Paddle Rod Leash is perfect for staying connected to your paddle or fishing rod when on your SUP. This dual-purpose leash stretches from 24'–60'. Swivel hooks and comfortable collars for a lot of attachment options.

VDF-AHSUP-A9-17



General Information

Rigging Estimate Guide (Diagrams)

Rigging Components

Electrical Components

Engine Accessories

Propellers

Maintenance Items

Oils & Lubes

Detailing & Trailer Supplies

Accessories & Apparel

Generators & Accessories



Airhead® Ocho Rios 1030 iSUP

A terrific value, Ocho Rios is a high pressure inflatable paddleboard that's lightweight and fast. It feels very similar to a hard board (can be inflated to 15 psi) and supports paddlers up to 220 lbs. Large EVA traction pad. Stainless tow ring and leash ring. 1 detachable tracking fin. High grade materials and workmanship for years of enjoyment. Includes Carry Bag, Pump, Gauge and Repair Kit. Dimensions: 10' 6" x 30" x 4" (320 x 76 x 10 cm) / 25 lbs. (11.4 kg). A great all around paddleboard.

VDF-55103-00-17



SS SUP 10.5' by Airhead®

SS stands for "Super Stable" and that's what these paddleboards are! They have integrated sponsons nearly the full length of the board that function like outriggers. Beginners, larger paddlers and fishermen love SS's unparalleled dry ride and stability. 3 Fins (2 x 4 in. fixed, 1 x 9" removable), 5 stainless D-Rings, Stretch Tie Down, Thick EVA Traction Pad, Hi Pressure Valve, Board size 10'8" x 38" x 4" (deck) / 6" (sponson), Board weight: 34 lbs., for Paddlers 120-300 lbs. Includes Mesh Backpack, Stainless Steel Tow Ring, High Pressure Hand Pump, Pressure Gauge, Valve Wrench, Board Strap & Repair Kit.

VDF-AHSUP-20-17

Travel Kayaks by Airhead®

Inflatable kayaks are perfect for camping, vacationing, exploring remote areas, and for cruising yachts. They're also great for paddling enthusiasts that don't want to drive around with a kayak on their rooftop! Airhead Travel Kayaks fit easily into the trunk of your car, duffel bag or suitcase. When you feel the itch to paddle the boat is with you!

One Person / Paddler **VDF-AHTK1-31-17**
 Two Person / Paddler **VDF-AHTK2-48-17**



Inflatable Boat by Airhead®

Airhead's inflatable boats are designed for fishing or good old fashioned family fun. They're lightweight, portable and ideal for lakes and slow moving streams. Constructed of heavy duty vinyl with electronically welded seams. Factory tested for quality assurance. Equipped with an Inflatable floor, wrap around tow rope, oar locks and oar holders. Repair kit included.

One Person **VDF-AHIB1-47-17**
 Two Person **VDF-AHIB2-54-17**
 Four Person **VDF-AHIB4-61-17**



Oars by Airhead®

These inexpensive oars are designed for use with AIRHEAD® and other inflatable boats. The 2 section aluminum shafts are durable and lightweight. The 15 in. high impact plastic blades and grips are designed for maximum rowing efficiency and comfort. Length: 53 in., 1 pair per package.

VDF-AHIB5-35-17



General Information

Rigging Estimate Guide (Diagrams)

Rigging Components

Electrical Components

Engine Accessories

Propellers

Maintenance Items

Oils & Lubes

Detailing & Trailer Supplies

Accessories & Apparel

Generators & Accessories

Tubes



Yamaha Single Sport Tube

You are sure to love the eye-catching graphics on this 54" round towable. The four neoprene knuckle guards and deluxe nylon covered handles provide a sure and comfortable grip. Self-draining floor vent. Features a reinforced internal tow harness, and Boston valve for quick inflation/deflation.

SBT-YHBL1-BL-18



Yamaha Inflatable Single Rider Tube Kit

Just about everything you'll need for an enjoyable day on the water - in a box! Box includes a 54" diameter deck tube with four deluxe handles and neoprene knuckle guards, and equipped with a Boston valve for your inflating and deflating convenience. Includes a portable 12-volt pump that will inflate quickly and effectively. Also includes a color-matched 16-strand tube tow rope. Features a reinforced tow harness, drain vents, and boarding straps.

SBT-YCR58-BL-18



Yamaha 2-Rider Winged Deck Tube

Get way up on edge with this U-shaped winged towable when riders shift their weight. Thicker at the front to prevent submarining and thin at the back to make it easier to climb on from the water. Deluxe handles with neoprene knuckle guards to provide a sure and comfortable grip. Two oversized neoprene pads are strategically located to protect knees and elbows. Durable 30 gauge reinforced welded PVC bladder completely wrapped in double-stitched 840 denier nylon, Heavy-duty Kwik-Connect™ provides easy and secure tow-rope hook-ups. Boston valve makes it easy and fast to deflate and inflate. Measures 73" x 61" deflated. 340 lb. weight limit.

SBT-YHMX2-00-17



Yamaha 3-Rider Deck Tube

This high performance deck tube features: Six deluxe nylon-wrapped handles, Neoprene knuckle guards provide a sure and comfortable grip. Heavy-duty Kwik-Connect™ for easy and secure hook-ups. 30-gauge virgin PVC bladder is fully covered with an 840D double-stitched nylon cover. Boston valve provides the ultimate in inflation and deflation convenience. Designed for up to 3 riders up to a total weight of 340 pounds. Measures deflated: 78" x 75".

SBT-YHGF3-00-17

Boards, Skis and Loungers

Airhead® Combo Water Ski

Perfect for skiers who need a stable ride and want to advance their skills, AIRHEAD's® combo water skis are a great value for the recreational water skiing family. These 67" rim molded combo water skis are designed to accommodate many different skill levels. The tunnel shaped bottom, wide tails and mild rocker provide easier starts, smooth turns, and better stability. The durable composite construction and fiber glass reinforced nylon fins ensure years of service. Dual density slide-type adjustable bindings fit adult sizes 5-12.

VDF-AHS13-00-17



Monsta Splash Widebody Trainers

47" wood trainers for beginners under 100 lb. Double-handle rope assembly, removable crossbar, and tail ties make it easy to start and control. Fiberglass reinforced nylon rudders increase stability and tracking. Adjustable bindings fit children size 12 to adult size 5.

VDF-AHST1-10-17



Wake Shaker Knee board by Airhead®

Newly designed channeled bottom, Reduces water tension for a light, responsive feel. Intergrated EZ UP hook provides effortless starts and easy access to the rope handle. Great for all riding levels.

VDF-AHKB3-00-17



Yamaha Rock 'n' Tow Tube

This is a tube and recliner in one! The double webbing foam handles are perfectly located for you to sit back, relax, and enjoy the ride. Little ones will enjoy the comfortable backrests and smooth ride. Made from rugged, double-stitched nylon cover and heavy-gauge PVC bladder. Features a patented speed safety valve for the ultimate in inflating and deflating convenience.

SBT-53522-00-18



General Information

Rigging Estimate Guide (Diagrams)

Rigging Components

Electrical Components

Engine Accessories

Propellers

Maintenance Items

Oils & Lubes

Detailing & Trailer Supplies

Accessories & Apparel

Generators & Accessories

Inflatable Pumps and Valves



12-Volt Air Pump

This high-volume (290 liters/minute) 12-volt portable air pump inflates and deflates towables, boats, pools, mattresses, and beach toys quickly and effectively. Most pumps on the market don't put out this kind of air pressure and volume (9.6 cu. f.t./min. 0.8 psi). The universal valve fittings fit all popular valves. For added convenience, the cigarette lighter/12-volt power port plug is equipped with a 10' long power cord.

MAR-12VPU-MP-06



Airhead® 120 Volt Hi-Pressure Air Pump

A Pressure Release Valve is included to limit pressure to 1.4 psi for preventing over-inflating towables, pool toys and other vinyl and nylon covered inflatable items. Four universal valve fittings fit all popular valves and lock onto the hose. For added convenience, there's a carry handle and a 10' long power cord. Draws 6.1 amps /730 watts. Volume is 460 liters/minute.

VDF-AHP12-0H-17



Air Pig 12V Pump by Airhead®

This pump is called AIRHEAD AIR PIG to extol its high volume, high pressure capabilities. The quiet motor puts out 1.2psi, plenty of pressure for most inflatables, including towables, boats, lounges and pool toys. Equipped with a 10' power cord with alligator clips and a 24" reinforced hose that locks onto the pump. Four adapters for the most popular air valves are included. Draws 22 amps / 260 watts.

VDF-AHP12-AP-17

Airhead® Double Action Pump

Perfect For “Topping off” towables. This double action pump inflates and deflates towables, kayaks, boats, airbeds, and other inflatables. It delivers a continuous stream of air on both the up and down strokes. Simply turn the release valve counterclockwise and you’re pumping air only on the downstroke. This is a great option when your inflatable is almost full and there’s back pressure. Four universal valve fittings are included to fit Boston valves and stem valves. The accordion-style hose stretches to 5' long and interlocks to the pump, so that it doesn’t fall off while you’re pumping. Volume is 2 liters/stroke. Very effective for “topping off” large towables in the boat, since peak pressure is an impressive 14 psi.

VDF-AHP10-00-17



Airhead® Multi -Valve

Inflate with Speed & Flexibility AIRHEAD® MULTI-VALVE consists of two Boston valves with different thread patterns on the bottom and a Schrader® valve with cap. One of the Boston valves is sure to fit the thread pattern of your inflatable, no matter what brand. The Boston valves have a square base, which is much easier to turn than a round base, especially with wet hands. Use the Schrader® valve to inflate your inflatables at a gas station or with an air compressor. Alternatively, screw off the Schrader® valve and inflate the Boston valve with an AIRHEAD® air pump. All components are bright red and green, so they’re easy to find.

VDF-AHBV2-98-17



General Information

Rigging Estimate Guide (Diagrams)

Rigging Components

Electrical Components

Engine Accessories

Propellers

Maintenance Items

Oils & Lubes

Detailing & Trailer Supplies

Accessories & Apparel

Generators & Accessories

Audio Equipment



JBL® MR-18 Sirius®-Ready Am/Fm/Cd Receiver

Sirius®-ready. 180 watts (45W x 4) peak. Waterproof face. Two pairs of line output terminals. iPod® ready with aux in. Flip-down face. EPS Unique two-line display. Random/repeat play. Intro scan. Beep-tone support. Detachable control panel with carrying case. Overall size: 7-3/8" W x 2-1/4" H x 7-3/4" D. iPod® is a registered trademark of Apple Inc.

GCA-JVCKD-R9-9M



Universal Marine Antenna

This antenna should be used when installing a stereo system in a boat. Professional installation is recommended.

MAR-ANTEN-NA-02



Milennia® MA100 Speaker/Amp Package

Milennia® speaker package includes a Milennia® MA-100 amp that features fully marinated circuit boards to keep salt and corrosion away from the critical circuit path and an onboard high/low filter. The MA-100 amp is great for adding another pair of speakers. 45 Watts, 20W RMS. Overall amp size: 4 3/8"L x 3 3/16"W x 1-9/16"H. Includes two Seaworthy® 5582 5" 75-watt weatherproof speakers. Speakers feature a 5 oz. magnet and 1" tweeter. Includes a 72" mini plug that connects to the amplifier and features an AUX input that will accept any source of music through a mini DIN plug stereo connection. Overall speaker size: 5 3/4"W x 2 1/2"D x 5 3/4"H

GCA-MA100-10-00



HT-2 Full Range Class D Amplifiers by Wet Sounds™

Wet Sounds™ Hydro-Tech™ Series Marine Amplifiers are designed to be a complete solution for every type of extreme marine application. The Hydro-Tech™ amplifiers use superior performance circuitry by utilizing Class Power Supplies. These amplifiers have extreme power output packed inside a small chassis, thermal overload protection, flexible crossovers, optional elevated feet, extended inputs. Hydro-Tech™ amplifiers are a well balanced match for all of the Wet Sounds™ products.

2-Channel: **SBT-HTX20-00-17**

4-Channel: **SBT-HTX40-00-17**

6-Channel: **SBT-HTX60-00-17**

Syndicate Series Full-Range Marine Amplifiers

Wet Sounds™ Syndicate Series Marine Amplifiers represent the highest performing marine audio amplifiers on the market, with advanced technologies like Class H and Class G/H power supplies for high power with less current draw and less heat. Microprocessor-controlled, forced-fan cooling. Full polished stainless steel chassis for true marine grade, with conformal-coated PCB boards, advanced microprocessor protection circuit for under/over voltage, thermal overload and short protection, flexible crossovers for both high pass and low pass use on full range models, and matched power ratings to drive all Wet Sounds™ speakers.

Syndicate 4: Full Range 4-Channel Amplifier

Stereo @ 4 Ohms = 125 x 4 watts RMS; Stereo @ 2 Ohms = 200 x 4 watts RMS; Mono @ 4 Ohms = 400 x 2 watts RMS

SBT-DX400-00-17

Syndicate Micro: Full Range 2-Channel Class H Amplifier

Stereo @ 4 Ohms = 200 x 2 w atts RMS; Stereo @ 2 Ohms = 350 x 2 watts RMS; Mono @ 4 Ohms = 700 x 1watts RMS

SBT-DX200-00-17



Stealth Ultra Series Sound Bars by Wet Sounds®

This sound bar is built with a full extruded aluminum housing, Bluetooth® enabled audio receiver, improved bass response, new connectors, and a high performance speaker array, Titanium dome tweeters for a rich and dynamic full range performance. Powered by a full-range Class D amplifier featuring auxiliary inputs, and 2-Volt line driver output to link to an additional sound bar or add external amplifier and speakers. Includes waterproof connector, universal L-mount brackets for end cap mounting or sliding top mount Channel system, auto turn-off feature to save battery life, backlit LED illuminated control panel, and fully integrated wiring harness.

6 Speaker **SBT-STL6U-WT-17**

10 Speaker **SBT-ST10U-WT-17**





XS-65 6-1/2 Coaxial Speaker

The XS-65 is a 6-1/2" component-style coaxial speaker. Silver grille. Rubber spider and surround. Nylas (nylon fiber glass) frame/grille. Injection molded composite cone. Horn flare Mylar® tweeter. Rubber magnet boot. Impedance: 4 ohms, RMS Watts: 60, Peak Watts: 120, Frequency Response: 40Hz to 20KHZ. (Sold in pairs.)

Black **SBT-XS65B-BK-11**

Silver **SBT-XS65S-IL-11**



SW-65 6-1/2" Coaxial Speaker

The SW-65 is a 6-1/2" component style coaxial with a closed-grille aesthetic perfect for saltwater boats and runabouts. Impedance: 4 ohms, RMS Watts: 60, PEAK Watts: 120, Frequency Response: 40Hz to 20KHZ. (Sold in pairs.)

Black **SBT-SW65B-BK-11**

White **SBT-SW65W-WT-11**



10" Free Air Marine Subwoofer

The XS-10FA is a 10" Free Air marine subwoofer. Powder-coated cast aluminum frame. Gold-plated speaker terminals, injection-molded composite cone, rubber spider and surround. Comes with a grille. Impedance: 4 ohms, RMS Watts: 300, Peak Watts: 600, Frequency Response: 20Hz to 500HZ.

Silver **SBT-XS10F-AD-11**

White **SBT-SW10F-WT-11**



Revolution™ 8" EFG™ 4 ohm EFG™ HLCD Tower Speaker

The Revolution™ Series uses the Wet Sounds™ proprietary REV TEC™ technology. Unlike most conventional designs, REV TEC™ technology provides remarkable volume and amazing full range sound quality on axis and off axis at long distances. Extensive acoustic testing has confirmed these speakers ability to project volume at 80 feet and beyond without any loss of detail or information. Includes swivel clamp. Impedance: 4 ohms, RMS Watts: 200, Peak Watts: 400, Frequency Response: 20Hz to 20KHZ. (Sold in pairs.)

Black **SBT-REV8B-LK-11**

White **SBT-REV8W-HT-11**

Battery Chargers and Battery Switches

OptiMate® 4 Battery Charger

A truly diagnostic 0.8 amp battery optimizer for 12V lead-acid batteries (sealed maintenance-free, gel, or filler caps). Like OptiMate® models, the microprocessor-controlled OptiMate® 4 can save neglected batteries and is even more effective with its new dual-stage "Recovery" and "Turbo Recovery" desulfating action. Sealed waterproof enclosure is ideal for snowmobiles and watercraft and also has special cables and bushings for ultra-cold temperatures down to -40° F. New shape includes wall mounts, and now shows current display, hourly testing plus 24/7 maintenance. Recommended for all 12V lead-acid batteries up to 75Ah.

DBY-ACC51-70-15



Replacement Fused Eyelet Connection Set Weatherproof, permanent connector (with 15A fuse). Hook up your battery quickly and easily when not in use. For use with OptiMate® 4 and OptiMate® 3+ battery chargers. Adapter (ACC-OPTIM-3P-AD) required for use on older OptiMate® III model.

DBY-ACC56-23-81

Battery Tender® Water Proof 800

This compact battery charger has all the charge characteristics of its cousin, the Battery Tender® Junior. It incorporates highly efficient surface mount technology electronic components. The interior is completely encapsulated, protected from shock, vibration, and moisture by an electrically insulating, thermally conductive, flame retardant, synthetic epoxy resin compound. It's tough, affordable, and a strong, innovative battery charging solution. This charger is no larger than a standard computer mouse yet packs 800 milliamps of pure constant current charging power. Coupled with a brain (IC chip), the charger will constantly monitor, charge, and then maintain your battery even while totally submersed underwater! Perfect for all outdoor types of watercraft, boats, motorcycles, ATVs, or any where water is a threat. Charges 12V @ 800mA.

SBT-BTWP8-00-11



Battery Tender® Junior

Trickle Charger with a Brain. Features Include: Lightweight/compact size Ideal for hard-to-fit spots Fully automatic 2-stage lead-acid battery charger. Solid-state two-color LED indicates state of charger Spark-proof Reverse-polarity protected 12-foot output cord Quick connect harness

ACC-CHGJR-BT-12



General Information

Rigging Estimate Guide (Diagrams)

Rigging Components

Electrical Components

Engine Accessories

Propellers

Maintenance Items

Oils & Lubes

Detailing & Trailer Supplies

Accessories & Apparel

Generators & Accessories



Battery Tender® Plus

Fully charges and maintains battery at proper storage voltage. Temperature compensation. Powder-coated aluminum chassis. Spark proof. Built-in 72-hour timer will protect a marginal battery from overcharging. Charges as fast as a 3-amp charger using only 1.25 amps. Reserve polarity protected. Complete 3-step charging program. Quick-connect harness. Five-year manufacturer's limited warranty.

ACC-CHGBT-TN-12



OptiMate® 1 Battery Charger

Never have another dead battery! The OptiMate® 1 Charger can be left plugged into any vehicle's 12-volt battery all season long. Charges all battery types. Comes standard with clip type lead and weatherproof permanent adaptor for quick and easy connect/disconnect. LED's for power on, charging, and charged battery states. 2 year limited warranty from the manufacture.

DBY-ACC51-70-11

SAE-71 Connector Quick-Disconnect Lead **DBY-ACC56-23-81**



Solar Panel With Built -In Controller

5-watt solar panel with built-in Battery Tender® super smart charging controller. 100% portable battery charging and maintenance. Perfect for storage space without power access! Battery Tender® solar panels are the only panels available with a built-in charge controller to prevent overcharging. 12V Nominal Voltage 270 mAmps. Temperature compensation sensor. Spark-proof. 3 lb. 13.25" x 16" x 0.875"

5 Watt: **SBT-BTSOL-AR-11**



Marine Dual Battery Kit

This kit is a must-have when adding additional electronics to your boat (stereo upgrades, bars, etc.). This kit comes complete with a BEP Marine Battery 701S™ Battery Switch, a BEP Marine Voltage Sensitive Relay (VSR), and a GIL Marine Composite Battery Box plus all necessary wiring and hardware. This kit will allow you to keep one battery isolated at all times for reserve purposes. The VSR will allow the engines to charge battery #1 until it is topped off at 13.7 VDC, then automatically switch over to battery #2 to charge it. Turn the knob on the battery switch to select using battery #1 by itself, battery #2 by itself, or both batteries together in parallel. You can also switch off battery current altogether. Professional installation recommended. Marine batteries not included. Fits any single battery boat with room for another 24 battery.

SBT-DUALB-AT-08

Magma® Grills and Accessories

Magma® Newport™ Gourmet Gas Grill

Just right for grilling up to eight large hamburgers. The Newport™ is a finely crafted piece of hardware. Now with fold-away legs making this the go-any -where grill to enhance all of your out door activities. Its beauty, performance, and safety features will certainly exceed the expectations of the most discriminating grill enthusiast. It grills quickly , evenly, and disassembles easily for cleaning. Uses inexpensive, disposable 1-lb. propane cylinders or adapts to on-board LPG (propane) or CNG (natural gas) systems. (Serving shelf and fuel canister shown in picture not included.)

SBT-NEWPO-RT-11



Padded Grill & Accessory Carrying/Storage Case

Conveniently store and transport your grill and accessories in one of Magma's® new padded carrying cases. Designed to store all of your grilling gear in one space-saving location. This bag is outfitted with a large storage compartment for a grill, pockets for storing a serving shelf, griddle, and fish/veggie tray. Includes an additional side pocket for storing up to two 1-lb. propane canisters and two control valve/ regulators. Additional features like thick padding for maximum protection and heavy-duty carrying handles and strap make this a must-have for every grilling enthusiast. With the same quality and craftsmanship you've come to expect, once again Magma® has just what you've been looking for.

SBT-GRILL-BG-11



Magma® 5-Piece Professional Grill Tool Set

This 5-piece set from Magma® includes four telescoping professional quality grilling tools and a carrying case. Made of mirror-polished, marine-grade 18-9 stainless steel with rubberized, soft-touch handles for easy, secure grip. Tools adjust to three different operating lengths to meet any griller's needs and they completely collapse for compact storage in their own quality storage case. Optional high-intensity LED lights are also available that quickly attach to any of the tools and provide bright light to any food being grilled.

SBT-UTENS-5P-12



General Information

Rigging Estimate Guide (Diagrams)

Rigging Components

Electrical Components

Engine Accessories

Propellers

Maintenance Items

Oils & Lubes

Detailing & Trailer Supplies

Accessories & Apparel

Generators & Accessories

Coolers



Yamaha Inflatable Floating Cooler

The Yamaha Inflatable Floating Cooler is an insulated leak-proof nylon cooler that is removable from the inflatable base by simply lifting on the adjustable shoulder strap. It keeps 12 cans or bottles and ice cold for hours. The 6 drink holders in the floating base are marked with numbers to help you and your friends keep track of your drinks. A molded plastic rope connector is sewn to the durable nylon cover for tying up to your WaveRunner®, boat, dock, etc.

MAR-FLTCL-ER-06



Yamaha Soft Side Cooler

This cooler is ideal for keeping your beverages and snacks cool. Features include zippered storage compartment easily holds 24 cans plus ice, waterproof liner and high-density insulation keeps ice longer and contents cooler. Unique adjustable securing panel helps hold contents in place while in motion. Includes a shoulder strap and a Yamaha logo bottle opener. Approximate dimensions: 18" L x 7" W x 12" D.

B8K-F847U-V0-00

Boat St



Yamaha Boat Starter Kit

Here's a convenient way to get started with supplies you need for your Yamaha Boat. Kit provides four U.S. Coast Guard Approved/UL Listed PFDs that are adjustable to fit most adults (sizes small to large), plus an approved Type IV throwable flotation device, and a generously sized nylon case to store them in when you aren't boating. Kit also includes a 3.5-oz. air horn and an easy-to-pack first aid kit. For your docking needs, the kit has two black Yamaha 24" Boat Contour Fenders, two No-Slip Fender Straps (shown attached to cleats, not included), and four white 15-foot dock lines. Accented with the Yamaha logo.

Yamaha **SBT-BOATK-IT-08**

Non-Branded **SBT-BOATK-IT-09**

General Boating Accessories and Upgrades

Yamaha Kidney Shape Table

Want to upgrade your stock table to a larger size? This big table offers more functionality, with a kidney shape so it is easy to maneuver around it, yet it still fits in the stock storage location on your Yamaha Boat. It also has three cup holders instead of two as on the stock table. Designed as a direct replacement, this table is made of the same acrylic capped ABS material as the stock table, and uses the same hardware. Requires transfer of the pedestal base from the stock table.

SBT-KDNYT-BL-08



Yamaha Emblem

Show your Yamaha pride on your vehicle with these new high quality 3D metal logo decals. 16" x 3.2". (Sold as a set of 2.)

SBT-DECAL-3D-08



Tuning Fork Emblem

Factory Yamaha emblem.

F0C-U411H-00-00



YAMAHA 6", 12", 24" WHITE DECAL

Go bold with this Yamaha decal! This 6" die-cut decal features the Yamaha logo.

White:

VDFDC00106WH (6")
 VDFDC00112WH (12")
 VDFDC00124WH (26")

Red:

VDFDC00106RD (6")
 VDFDC00112RD (12")
 VDFDC00124RD (24")



General Information

Rigging Estimate Guide (Diagrams)

Rigging Components

Electrical Components

Engine Accessories

Propellers

Maintenance Items

Oils & Lubes

Detailing & Trailer Supplies

Accessories & Apparel

Generators & Accessories

Accessories and Apparel

General Information

Rigging Estimate Guide (Diagrams)

Rigging Components

Electrical Components

Engine Accessories

Propellers

Maintenance Items

Oils & Lubes

Detailing & Trailer Supplies

Accessories & Apparel

Generators & Accessories



Series 800 Registration Kits

3" Block style, solid body with bevel effect, Contrasting outline, Kits include four sets of A-Z and 0-9, Choose from four color combinations. Meets USCG requirements.

Blue/Black **SBT-BLBLK-80-13**

White/Black **SBT-LTBLK-80-13**

Red/Black **SBT-REBLK-80-13**

Silver/Black **SBT-SIBLK-80-13**



Premium Registration Kits

3" Block style, solid body contrasting outline. All kits include four sets of A-Z and 0-9. Choose from color combinations or solid options below. Meets USCG requirements.

Black/Beige **SBT-BLBKE-70-11**

Blue/Black (shown) **SBT-BLBLK-70-11**

Chrome/Black **SBT-CHBLK-70-11**

Silver/Black **SBT-SIBLK-70-11**

Red/Black **SBT-REBLK-70-11**

Solid Black **SBT-BLK70-00-11**



Multi Color Registration Kits

Contains four fuel-resistant stickers of each letter (A~Z) and number (0~9). Meets U.S. Coast Guard regulations.

Brown/Black **MAR-BRBKG-20-89**

White/Black **MAR-WHBKG-20-19**

Silver/Black **MAR-SIBKG-20-16**

Blue/Black (shown) **MAR-BLBKG-20-65**

Yellow/Black **MAR-YEBKG-20-13**

Red/Black **MAR-REBKG-20-28**

Chrome/Black **MAR-CHBKG-20-43**



Solid Color Registration Kits

Contains four fuel-resistant stickers of each letter (A~Z) and number (0~9). Meets U.S. Coast Guard regulations.

Black **MAR-BLK35-00-14**

Blue **MAR-BLU 35-00-15**

White **MAR-WHI35-00-21**

Red (shown) **MAR-RED35-00-00**

Life Line™ Boat Safety Kit

This boat safety kit contains 4 items. Recommended for all boats. Contents: 15 meter (50 ft.) buoyant heaving line, bailer (watertight container), sound signaling device (pea-less whistle), and watertight flashlight.

VDF-LL200-00-17



Waterproof First Aid Kit

You'll always know where to find your first aid kit, and the contents will be clean and dry. Easily mounts to boats, or almost anywhere with self adhesive hook and loop. The heavy-duty nylon bag is specially coated and has a waterproof zip closure to ensure that your first aid supplies stay dry. (Contents may vary slightly)

VDF-FRSTA-ID-17



Telescoping Paddles

This lightweight paddle adjusts easily to variable lengths with a simple twist. A section of the aluminum shaft disappears inside the blade to allow for ultra-compact storage under boat seats. The corrosion resistant aluminum shaft, hassle free locking device and high-impact molded blade and boat hook handle provide years of service.

Yamaha Branded Blue Paddle (20"~45") **MAR-DLXPA-DL-42**

Bright Orange Paddle (20"~45") **VDF-P1PDL-00-17**

Bright Orange Paddle (25.5"~72") **VDF-P3PDL-00-17**



Yamaha Type IV Throwable Flotation Device

U.S. Coast Guard regulations require your Yamaha Boat to have a Type-IV throwable flotation device aboard. This USCG-approved cushion is constructed of high-buoyancy polyethylene foam with durable nylon fabric.

Yamaha Branded White **MAR-LIFEP-WT-07**

Non-Branded Blue **VDF-LIFEP-BL-17**

Non-Branded White **VDF-LIFEP-WH-17**



General Information

Rigging Estimate Guide (Diagrams)

Rigging Components

Electrical Components

Engine Accessories

Propellers

Maintenance Items

Oils & Lubes

Detailing & Trailer Supplies

Accessories & Apparel

Generators & Accessories



HYDRO-TURF® Step Mats

These 4" x 15" Hydro-Turf® pads have many uses. Charcoal or Brown with 3M™ PSA self-stick adhesive. (Set of 2.)

Charcoal **SBT-4X15M-AT-CH**



CIPA Comp Universal Boat Mirror

A truly universal 7" x 14" mirror. Features a ball and socket tension adjustment knob that will keep the mirror where you position it. Bracket will mount to rectangular or round-top windshield frames from 3/8" to 1-1/4". Meets Alabama's 78-square-inch law.

SBT-20000-00-10



CIPA Suction Cup Mirror

No holes to drill, no tools required, no scratching! Attaches to any clean, smooth, non-porous surface. Dash, console or windshield mount. Fully adjustable 4" x 8" mirror.

SBT-11050-00-10



CIPA Ellipse Mirror

4" x 11" multi-lens mirror features one stationary and two adjustable lenses. Also has a ball and socket tension adjustment knob that will keep the mirror where you position it. CIPA's windshield frame bracket will mount to rectangular or round-top windshield frames from 3/8" to 1-1/4".

SBT-20020-00-10

Personal Flotation Devices

Men's Yamaha Neoprene 2-Buckle PFD

The Yamaha Neoprene 2-Buckle PFD is made with synthetic neoprene and segmented foam panels for a comfortable fit. Features convenient front zipper and two buckles. U.S. Coast Guard approved and UL listed. Also available in other colors.

Green **MAR-17VNE-GN (SM,MD,LG,XL,2 XL)**

Black **MAR-17VNE-BK (SM,MD,LG,XL,2 XL)**

White **MAR-17VNE-WH (SM,MD,LG,XL,2 XL)**

Blue **MAR-17VNE-BL (SM,MD,LG,XL,2 XL)**



Women's Yamaha Neoprene 2-Buckle PFD

The Yamaha Neoprene 2-Buckle PFD is made with high quality neoprene and segmented foam panels for a comfortable fit. Features convenient front zipper and buckles. Bright colors for increased visibility. U.S. Coast Guard approved and UL listed. Also available in other colors.

Blue **MAW-17VNE-BL (SM,MD,LG,XL,2 XL)**

Pink **MAW-17VNE-PK (SM,MD,LG,XL,2 XL)**

Green **MAW-17VNE-GN (SM,MD,LG,XL,2 XL)**



Youth Yamaha Neoprene 2-Buckle PFD

The Yamaha Neoprene 2-Buckle PFD is made with Yamamoto neoprene and segmented foam panels for a comfortable fit. Features convenient front zipper. U.S. Coast Guard approved and UL listed. Also available in other colors.

Blue **MAY-15VNE-BL-YT**

Pink **MAY-15VNE-PK-YT**



Junior Yamaha Neoprene 2-Buckle PFD

The Yamaha Neoprene 2-Buckle PFD is made with Yamamoto neoprene and segmented foam panels for a comfortable fit. Features convenient front zipper. U.S. Coast Guard approved and UL listed. Also available in other colors.

Blue **MAY-15VNE-BL-JR**

Pink **MAY-15VNE-PK-JR**



General Information

Rigging Estimate Guide (Diagrams)

Rigging Components

Electrical Components

Engine Accessories

Propellers

Maintenance Items

Oils & Lubes

Detailing & Trailer Supplies

Accessories & Apparel

Generators & Accessories



Yamaha nylon/neoprene combo PFD-Unisex

Made from heavy-duty, coated nylon and comfortable neoprene construction. Features front zip entry with two belts for added strength. U.S. Coast Guard approved and UL listed.

Black **MAR-19NNC-BK (SM,MD,LG,XL,2 XL)**

Red **MAR-19NNC-RD (SM,MD,LG,XL,2 XL)**

Pink **MAW-19NNC-PK (SM,MD,LG,XL,2 XL)**



Yamaha value neoprene 2-buckle PFD-Unisex

Features front entry zip and 2-buckle closure in neoprene at a value price. U.S. Coast Guard approved and UL listed.

Black **MAR-19VVN-BK (SM,MD,LG,XL,2 XL)**

Blue **MAR-19VVN-BL (SM,MD,LG,XL,2 XL)**

Red **MAR-19VVN-RD (SM,MD,LG,XL,2 XL)**



Yamaha Nylon Mesh Fishing Life Jacket

Nylon mesh PFD with front zip entry, adjustable straps, two side release buckles, two double front storage pockets. U.S. Coast Guard approved and UL listed.

Blue **MAR-18FSH-BL (SM,MD,LG,XL,2XL,3XL)**

Green **MAR-18FSH-GN (SM,MD,LG,XL,2XL,3XL)**



Youth Yamaha neoprene PFD

Made with high quality neoprene and segmented panels for a comfortable fit. Features front zip closure, buckle and leg strap for added strength and security. Bright colors for increased visibility on the water. U.S. Coast Guard Approved and UL listed.

Black **MAY-19VNE-BK-YT**

Blue **MAY-19VNE-BL-YT**

Green **MAY-19VNE-GN-YT**



Childrens Yamaha neoprene PFD

Made with high quality neoprene and segmented panels for a comfortable fit. Features front zip closure, buckle and leg strap for added strength and security. Bright colors for increased visibility on the water. U.S. Coast Guard Approved and UL listed.

Blue **MAY-19VNE-BL-CH**

Green **MAY-19VNE-GN-CH**



Infant Yamaha Neoprene 1-Buckle PFD

The Yamaha Neoprene 1-Buckle PFD is made with high quality neoprene and segmented panels for a comfortable fit. Features front zip closure, buckle and leg strap for added strength and security. Bright colors for increased visibility on the water. U.S. Coast Guard Approved and UL listed.

Blue **MAY-19VNE-BL-IN**

Green **MAY-19VNE-GN-IN**



JETPILOT® PFD for Dogs

Made from lightweight nylon with flexible neoprene. Float padding inside the upper section of the vest with soft padding in the front. Flexible neoprene on the chest area. Includes adjustable buckles and Velcro® attachments. Also includes a nylon carry/lift handle on top along with a loop ring for a leash.

SIZE	X-SMALL	SMALL	MEDIUM	LARGE	X-LARGE
LENGTH	9-11"	11-13"	13-16"	16-19"	19" +
WEIGHT	Up to 15 lb.	15-20 lb.	20-50 lb.	40-70 lb.	Over 70 lb.
GIRTH	22"	26"	28"	30"	33"

WJP-17210-(COLOR)-XS
WJP-17210-(COLOR)-SM
WJP-17210-(COLOR)-MD
WJP-17210-(COLOR)-LG
WJP-17210-(COLOR)-XL



Side Entry Nylon PFD

Made from heavy-duty coated nylon with convenient side entry. Features front, side, and back foam and screen printed Yamaha logos. Adjustable straps and three side buckles for added safety. U.S. Coast Guard Approved/UL Listed. Unisex. (SD-Fits Small/Medium LX-Fits Large/Extra Large)

Blue **MAR-18VSE-BL (SD, LX)**

Black **MAR-18VSE-BK (SD, LX)**



Men's Yamaha 3-Buckle PFD

Made from heavy duty coated nylon with three buckles for added strength. Front, side, and back foam. U.S. Coast Guard Approved/UL Listed.

Blue **MAR-18V3B-BL-(SM~3X)**

Black **MAR-18V3B-BK-(SM~3X)**

Red **MAR-18V3B-RD-(SM~3X)**



Women's Yamaha Value Nylon 3 buckle PFD

This Yamaha Value nylon 3-Buckle PFD is made from heavy-duty coated nylon with 3-side release buckles for added strength. Features front, side, and back foam for a comfortable fit. U.S. Coast Guard approved and UL listed.

Blue **MAW-19V3B-BL-(SM~3X)**

Pink **MAW-19V3B-PK-(SM~3X)**

Teal **MAW-19V3B-TL-(SM~3X)**

Hats and Visors



Trail Breaker Mossy Oak® Camo Hat
VDF-18HTB-CA-MO



Yamaha Mesh Camo Hat
CRP-18HRT-CA-MO



Yamaha Essential Cap
CRP-13HYB-BL-NS



Yamaha Navy FlexFit® Hat
CRP-14HFF-NV-NS



Yamaha Contrast Stitching Hat
CRP-14HFF-NV-NS



Yamaha Pro Dry Fit Mesh Hat
CRP-17HCS-OL-NS



Yamaha 3D Felt Logo Hat
CRP-17HYA-ES-GY



Yamaha Tuning Fork Mesh Hat
CRP-16HYA-BK-NS

General Information

Rigging Estimate Guide (Diagrams)

Rigging Components

Electrical Components

Engine Accessories

Propellers

Maintenance Items

Oils & Lubes

Detailing & Trailer Supplies

Accessories & Apparel

Generators & Accessories

Accessories and Apparel



Yamaha Pure Contrast Cap
CRP-13HMS-NV-NS



Yamaha Mesh Hat
CRP-18HMU-LT-NS



Yamaha Visor
CRP-14HVI-BL-NS
CRP-16VYA-BK-NS



Basic Yamaha Beanie
100% acrylic. 3D Yamaha embroidery.
Blue *CRP-13HBN-BL-NS*



Yamaha Pro Pure Contrast Hat
CRP-15HPF-BL-NS



Yamaha Pro Fishing Beanie
CRP-15BNE-GY-NS



Yamaha Pro Fishing Visor
CRP-15VPPF-BL-NS



Yamaha Pro Fishing Hat
Blue and White - *CRP-14HPR-WH-NS*
Blue with Black Bill - *CRP-16HPF-BK-NS*



Yamaha Pro Fishing Neck Gaiter
CRP-17GTR-BL-NS

General Information
Rigging Estimate Guide (Diagrams)
Rigging Components
Electrical Components
Engine Accessories
Propellers
Maintenance Items
Oils & Lubes
Detailing & Trailer Supplies
Accessories & Apparel
Generators & Accessories



Yamaha Black Tactical Cap
VDF-18HSP-BK-NS



Wake Mesh Back Hat
VDF-18HHP-GY-NS



Yamaha Womens Performance Hat
Blue: CRW-17YAM-BL-UE
Coral: CRW-18YAM-CR-AL



Yamaha Striped Trucker Cap
VDF-18HSP-BL-NS



Sun and Surf Black Mesh Back Hat
VDF-18HSS-BK-NS



Sun and Surf Sublimated Multi Color Hat
VDF-18HSS-MU-NS

General Information

Rigging Estimate Guide (Diagrams)

Rigging Components

Electrical Components

Engine Accessories

Propellers

Maintenance Items

Oils & Lubes

Detailing & Trailer Supplies

Accessories & Apparel

Generators & Accessories

Apparel & Gifts



Yamaha Tee
 Black: **CRP-18TGN-BK-(SM-3X)**
 White: **CRP-18TGN-WH-(SM-3X)**



Yamaha Established Tee
 Gray: **CRP-18TGN-GY-(SM-3X)**
 Olive: **CRP-18TGN-OL-(SM-3X)**



Heritage Blue Blended Tee
VDF-18THE-BL-(SM, LG-3X)



Yamaha Pro Fishing Jersey
CRP-14JPF-WH-(SM~3X)



Yamaha Pro Fishing Short Sleeve Tee
CRP-14SPF-BL-(SM~3X)



Yamaha Pro Fishing Freshwater Tee
CRP-18TVM-BK-(SM~3X)



Yamaha Pro Fishing Saltwater Tee
CRP-18TDF-BK-(SM~3X)

General Information
 Rigging Estimate Guide (Diagrams)
 Rigging Components
 Electrical Components
 Engine Accessories
 Propellers
 Maintenance Items
 Oils & Lubes
 Detailing & Trailer Supplies
Accessories & Apparel
 Generators & Accessories



Coast Grey Wave Tee
VDF-18TCT-GY-(SM-2XL)



Heritage Men's Black Cotton Tee
VDF-18THG-BK-(SM-2XL)



Heritage Men's Indigo Cotton Tee
VDF-18THG-BL-(SM-2XL)



Coast Men's Blue and White Baseball Tee
VDF-18TCT-WH-(SM-2XL)



Sun and Surf Men's Red and White Baseball Tee
VDF-18TSS-WH-(SM-2XL)



Sun and Surf Unisex Full-Zip Hooded Sweatshirt
VDF-18FSS-RD-(SM-2XL)

General Information

Rigging Estimate Guide (Diagrams)

Rigging Components

Electrical Components

Engine Accessories

Propellers

Maintenance Items

Oils & Lubes

Detailing & Trailer Supplies

Accessories & Apparel

Generators & Accessories

Accessories and Apparel

General Information

Rigging Estimate Guide (Diagrams)

Rigging Components

Electrical Components

Engine Accessories

Propellers

Maintenance Items

Oils & Lubes

Detailing & Trailer Supplies

Accessories & Apparel

Generators & Accessories



Yamaha L/S Red Tee
CRP-18LGN-RD-(SM~3X)



Yamaha Pro Fishing
Moisture-Wicking Long Sleeve
CRP-14SLS-BL-(SM~2X)



Yamaha Pro Fishing Long
CRP-14LPF-BL-(SM~3X)



Yamaha Pro Fishing
Saltwater Gray L/S
CRP-18LML-GY-(SM~3X)



Yamaha Pro Fishing
Freshwater Gray L/S
CRP-18LBS-GY-(SM~3X)



Yamaha Pro Fishing
Saltwater Blue L/S
CRP-18LDF-BL-(SM~3X)



Yamaha Pro Fishing
Freshwater Blue L/S
CRP-18LPF-BL-(SM~3X)



Yamaha Raglan Established Hoodie
CRP-18FGN-GY-(SM~3X)



Yamaha Raglan Vintage Hoodie
CRP-18FOP-GY-(SM~3X)



Yamaha Pro Fishing Hooded Fleece
CRP-17FPF-BL-(SM~3X)



Coast Hooded Long Sleeve
VDF-18LCT-WH-(SM~2XL)

General Information

Rigging Estimate Guide (Diagrams)

Rigging Components

Electrical Components

Engine Accessories

Propellers

Maintenance Items

Oils & Lubes

Detailing & Trailer Supplies

Accessories & Apparel

Generators & Accessories

Accessories and Apparel

General Information

Rigging Estimate Guide (Diagrams)

Rigging Components

Electrical Components

Engine Accessories

Propellers

Maintenance Items

Oils & Lubes

Detailing & Trailer Supplies

Accessories & Apparel

Generators & Accessories



Yamaha Vintage Gray Tee
CRW-18TOP-GY-(SM~2X)



Yamaha Established Tee
CRW-18TGN-OL-(SM~3X)



Womens Royal Muscle Tank
VDF-18TNK-BL-(SM~XL)



Coast Women's Relaxed Fit Tank Top
VDF-18TKC-WH-(SM~XL)



Sun and Surf Women's Black Relaxed Fit Tank
VDF-18TNK-BK-(SM~XL)



Sun and Surf Women's White Tee
VDF-18TSN-WH-(SM~XL)

Combination Tool Backpack and Trolley by Beta Tools

The Model #C6T is a combination tool backpack and trolley by Beta Tools designed with maximum mobility in mind. Telescopic handle for easy transport. Built-in castors with dustproof cover for use as rucksack. Two removable tool panels. Five functional exterior pockets.

VDF-60010-BE-00



Yamaha Duffle Bag by OGIO®

This bag features a large main compartment with one front zippered pocket and a mesh pocket. There is also a molded tech vault gadget protection pocket. Also features side zippered shoe storage with mesh ventilation and adjustable, removable padded shoulder strap.

GCR-17DUF-YA-BK



Yamaha Drawstring Bag

This Yamaha Drawstring Bag is a simple solution to carrying odds and ends. Made of 150D ripstop nylon, it features a large main compartment with deluxe drawstring cords and closure, and a two-toned zippered front pocket with access to custom ear bud port. Yamaha logo on the outside.

VDF-60010-BE-00



Dry Pak® Waterproof Duffels

Keep water out of this waterproof roll-top Dry Pak® duffel by simply rolling down the top a few times and snapping the side release buckles together. Unroll and open the duffel to enjoy the huge tapered access opening on top. Features a convenient water-resistant zippered pocket with storm flap on each side (one clear and one opaque), heavy-duty vinyl/polyester laminate material with electronically welded seams, a molded bottom that adds structure and protection to contents and an adjustable and removable shoulder strap. The high end plastic hardware ensures longevity. Great for boating, paddle sports, camping and scent-proof storage for hunting.

VDF-DPD1B-L8-17 - Blue

VDF-DPD1G-R2-17 - Green



General Information

Rigging Estimate Guide (Diagrams)

Rigging Components

Electrical Components

Engine Accessories

Propellers

Maintenance Items

Oils & Lubes

Detailing & Trailer Supplies

Accessories & Apparel

Generators & Accessories

Accessories and Apparel

General Information

Rigging Estimate Guide (Diagrams)

Rigging Components

Electrical Components

Engine Accessories

Propellers

Maintenance Items

Oils & Lubes

Detailing & Trailer Supplies

Accessories & Apparel

Generators & Accessories



Yamaha Marine Key Chain
MAR-KEYCH-AI-NB



Yamaha Marine Floating Key Chain
MAR-KEYCH-AI-NC (Blue)
MAR-KEYCH-AI-ND (Red)



Wake Aluminum 24 oz. Bottle
VDF-18BAL-BL-24



Coast Silicone Water 24 oz. Bottle
VDF-18BCT-BL-24



Yamaha Black Growler
VDF-18BSP-BK-64



Yamaha 20oz Travel Mug
VDF-TM001-20-RD



Yamaha Campfire Mug
VDF-MG001-PC-CR



Yamaha Pint Glass
VDF-PNTGL-01-CL



Heritage Navy Campfire Mug
VDF-18MUG-HG-NV



Yamaha Collapsible Can Cooler
VDF-CK001-PC-BK (Black)
VDF-CK001-PC-RD (Red)



Wake Can Koozie®
VDF-18KZE-WK-BK



Yamaha zip up Bottle Koozie®
VDF-CK001-PC-BL (Blue)
VDF-CK001-PC-RD (Red)

Accessories and Apparel



Yamaha Folding Chair
VDF-CHAIR-01-BK



Tuning Fork Wall Clock
VDF-CLOCK-01-PC



Yamaha Counter Stool
VDF-CS001-PC-BK



Yamaha Trailer Hitch Cover
VDF-HC001-PC-BK

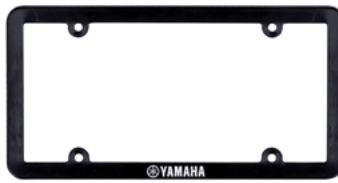

Yamaha License Plate Frame
VDF-LP001-PC-BK



Yamaha Sunglasses
VDF-SG001-PC-BK



Racing Shop Apron
ACC-YAMAP-RO-NR



Yamaha Lanyard
VDF-LY001-PC-RD



Yamaha Sports Watch
VDF-TM001-PC-RD



Yamaha Corporate Pen
VDF-BP001-PC-BK



Yamaha Balloons
VDF-BL050-PC-RD
(Sold in packages of 50)



Yamaha Frisbee
VDF-FB001-PC-BL

General Information

Rigging Estimate Guide (Diagrams)

Rigging Components

Electrical Components

Engine Accessories

Propellers

Maintenance Items

Oils & Lubes

Detailing & Trailer Supplies

Accessories & Apparel

Generators & Accessories

Accessories and Apparel



Yamaha Rectangle Pennants
(60' string repeating 9" x 12" pennants)
VDF-PENNT-60-RD



Yamaha Banner
(3' x 6') VDF-BN001-PC-SM
(4' x 16') VDF-BN005-BL-LG



Yamaha Shade Tent
(Blue) VDF-TENT1-PC-BL
(White) VDF-TENT1-PC-WH



Yamaha Garage Flag
(3' x 5') VDF-FLAG1-PC-WH



Yamaha Tin Sign
(17" x 6.7") VDF-SL001-PC-TN



Yamaha Magnet
VDF-MG001-00-WH



Yamaha Parking Sign
(12" x 18") VDF-PS001-PC-BL



Yamaha Floor Mat
(3' x 5') VDF-FLMAT-01-PC

General Information

Rigging Estimate Guide (Diagrams)

Rigging Components

Electrical Components

Engine Accessories

Propellers

Maintenance Items

Oils & Lubes

Detailing & Trailer Supplies

Accessories & Apparel

Generators & Accessories



Wrap It Up™ Rope Wraps
VDF-AR123-00-17 (3 pack)



Wrap It Up™ Rope Wraps
VDF-AR123-BK-17 (3 pack)

When managing utility cords becomes overbearing, the Wrap It Up™ Rope Wraps is a great solution. There are many uses for these 12 ½ " long hook and loop wraps. Use them at home, in the garage, on the job, camping, boating and fishing, just about anywhere. The hook and loop fasteners are sewn to durable 12" x 1 ½ " webbing and reinforced with a bar tack at each end. A cord is sewn onto WRAP IT UP™ for hanging items from peg hooks.



Waterproof Document Bags
SBT-WPDOC-BG-SM (5" W x 6"L)
SBT-WPDOC-BG-MD (7" W x 9"L)
SBT-WPDOC-BG-LG (10" W x 12"L)



Dry Pak® Case for Large Tablets
VDF-DPT91-2W-17



Dry Pak® Roll Top Dry Bag
VDF-AB664-54-17

Versatile and durable, your gear will stay dry inside these round bottom dry bags, even in adverse conditions. Shut out water by rolling down the top a few times and snapping the side release buckles together.



Yamaha Roll Top Bag
MWV-DRYBG-00-16

Versatile and durable, your gear will stay dry inside this round bottom dry bag, Features durable, waterproof, 19 oz. vinyl construction with reinforced welded seams and Yamaha logo graphic.

General Information

Rigging Estimate Guide (Diagrams)

Rigging Components

Electrical Components

Engine Accessories

Propellers

Maintenance Items

Oils & Lubes

Detailing & Trailer Supplies

Accessories & Apparel

Generators & Accessories

Yamaha Seascooter



Seascooter 350Li

Revolutionary underwater navigation with this next generation DPV (Diver Propulsion Vehicle). Runs up to 75 minutes with normal use (30 minutes continuous). Powered by a high performance, replaceable Lithium-ion battery. Weighs in at an extremely low 19 lbs including the battery. With a 3 level rotational speed control you can reach speeds up to 3.7 mph as well as go to depths of 130 ft. The Seascooter is enhanced with an automatic buoyancy system, that operates best in saltwater, as well as a superior flood prevention system.

VDF-350LI-YM-50



Seascooter RDS300

Revolutionary underwater navigation with this next generation DPV (Diver Propulsion Vehicle). Designed with a reinforced nose cone for extra protection. Runs up to 90 minutes with normal use (30 minutes continuous). Powered by a sealed lead acid battery. Weighs in at an extremely low 18 lbs including the battery. With a 2 level rotational speed control you can reach speeds up to 3 mph as well as go to depths of 100 ft. The Seascooter is enhanced with an auto shut-off, thermal switch function, water leakage sensor and the automatic buoyancy system, that operates best in saltwater, as well as a superior flood prevention system.

VDF-DS300-YM-00



Seascooter RDS250

Revolutionary underwater navigation with this next generation DPV (Diver Propulsion Vehicle). Runs up to 120 minutes with normal use (45 minutes continuous). Powered by a sealed lead acid battery. Weighs in at an extremely low 18 lbs including the battery. With a single speed control you can reach speeds up to 2.5 mph as well as go to depths of 100 ft. The Seascooter is enhanced with an automatic buoyancy system, that operates best in saltwater, as well as a superior flood prevention system.

VDF-DS250-YM-50



Seascooter Explorer

Revolutionary underwater navigation with this next generation DPV (Diver Propulsion Vehicle). Runs up to 60 minutes with normal use (20 minutes continuous). Powered by a sealed lead acid battery. Weighs in at an extremely low 11.5 lbs including the battery. With a single speed control you can reach speeds up to 2.5 mph as well as go to depths of 30 ft. The Seascooter is enhanced with an automatic buoyancy system, that operates best in saltwater, as well as a superior flood prevention system.

VDF-DS250-YM-50

Body Glove

Fiji Mask, Snorkel, and Fins Combo Set by Body Glove®

Fiji mask is made of Tempered glass meets all ANSI standards, Silicone facial skirt and strap for a soft and comfortable fit, Quick, adjustable strap — pull to tighten/push to loosen, Pivot buckle adjusts to strap angle for better fit. Excellent choice for smaller/narrower faces. Purge valve in mask to easily remove water. Unique snorkel design has a built-in GoPro® camera mount on the bottom that allows you to quickly and easily mount any GoPro® HERO® model. Dry top keeps water out of snorkel when underwater. Purge valve easily clears water from snorkel. Silicone mouthpiece reduces jaw fatigue, Medium-sized mouthpiece. Flex tube allows snorkel tube to adjust for better fit. Quick-release easily attaches and removes dive mask. Fins Flex system allows the blade to flex for more power. Flow channels make it easier to kick underwater; reducing fatigue. Flexible foot pocket comfortably adjusts to feet Quick-release, easy on and off. Drain hole allows water to flow through foot pocket. Non-slip thread bottom pattern helps prevent slipping. Size: 4.5-8.5 Small/Medium (SD); 9-13 Large/X-Large (LX)

Blue/Gray **VDF-039ST-BL-(SD,LX)**
 Yellow/Gray **VDF-039ST-YL-(SD,LX)**
 Red/Gray **VDF-039ST-RD-(SD,LX)**



Women's Aruba Mask, Snorkel & Fins Combo Set by Body Glove®

Aruba mask is made of Tempered glass meets all ANSI standards, Silicone facial skirt and strap for a soft and comfortable fit, Quick, adjustable strap (pull to tighten/push to loosen). Pivot buckle adjusts to strap angle for better fit. Specifically designed for women and is an excellent choice for smaller/narrower faces. Unique snorkel design has a built-in GoPro® camera mount on the bottom that allows you to quickly and easily mount any GoPro® HERO® model. Dry top keeps water out of snorkel when underwater. Purge valve easily clears water from snorkel. Silicone mouthpiece reduces jaw fatigue. Medium-sized mouthpiece. Flex tube allows snorkel tube to adjust for better fit. Quick-release easily attaches and removes dive mask. Fins have Flow channels make it easier to kick underwater reducing fatigue. Flexible foot pocket comfortably adjusts to feet. Quick-release easy on and off. Drain hole allows water to flow through foot pocket. Non-slip thread bottom pattern helps prevent slipping. Size: 5.5-9.5 Small/Medium (SD)

Blue/White **VDF-043ST-BL-SD**
 Pink/Purple **VDF-043ST-PK-SD**



General Information

Rigging Estimate Guide (Diagrams)

Rigging Components

Electrical Components

Engine Accessories

Propellers

Maintenance Items

Oils & Lubes

Detailing & Trailer Supplies

Accessories & Apparel

Generators & Accessories



Description	Page
Generator Basics	11-1
Terms to Know	11-3
Why Yamaha Generators	11-3
Generator Overview	11-4
Inverter Series	
EF1000iS	11-6
EF2000iSv2 / EF2000iSHv2	11-7
EF2400iSHC	11-8
EF2800i	11-9
EF3000iS	11-10
EF3000iSEB	11-11
EF4500iSE	11-12
EF6300iSDE	11-13
Premium Series	
EF2600	11-14
EF5500D / EF5500DE	11-15
EF7200D / EF7200DE	11-16
EF12000DE	11-17
Pressure Washers	11-18
Water Pumps	11-20
Generator Accessories	11-23
Pressure Washer Accessories	11-27
Generator Maintenance Parts	11-29
Yamalube® Products	11-31
Generator Wattage Application and Extension Cord Gauge Chart	11-32

General
Information

Rigging Estimate
Guide (Diagrams)

Rigging
Components

Electrical
Components

Engine
Accessories

Propellers

Maintenance
Items

Oils
& Lubes

Detailing &
Trailer Supplies

Accessories
& Apparel

Generators
& Accessories

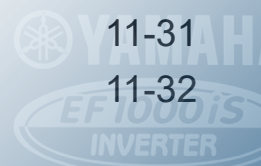

Generator Basics

Yamaha's legendary reliability is at the heart of our generator line up to help ensure they are there when you need them. Selecting which Yamaha Generator will meet your customer's needs can seem overwhelming until you have an understanding of some simple information and techniques.

The Yamaha Generator Model Number

Understanding the different benefits each model offers starts with an understanding of the model number. The image below shows an EF5200DE. The model code shows this is a Four Stroke Engine Generator capable of producing a maximum of 5200 watts in either 120v or 240v AC outputs and it has electric start.

EF = Four Stroke Engine

5200 = Maxium Output in Watts (kVA at 60Hz)

DE

- i** = Inverter Technology
- E** = Electric Starter
- D** = Dual(120V / 240V)AC Output
- B** = Boost Technology
- S** = Soundproof Type
- HC** = High Current
- H** = Hunter (Camouflage)

Inverter Vs. Conventional Generators

Both Inverter and Conventional generators produce the U.S. standard 60Hz A/C power. Yamaha's Premium Generators do a great job powering standard electronics like refrigerators, pumps, electric motors, and countless other items. However, as the use of microprocessors in everyday electronics such as, plasma TV's, computers, smartphones, and other modern devices continue to grow the inverter series becomes more important than ever.

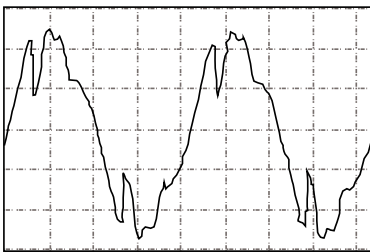

Conventional Generators Sine Wave

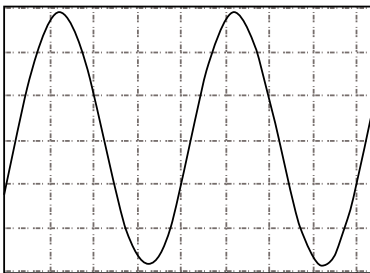

Inverter Generators Sine Wave

Conventional generators typically rely on maintaining an engine speed of 3600 RPM to create the required 60Hz sine wave. No matter how smooth an engine runs, the RPM will always move up and down ever so slightly. This normal engine speed variation increases sine wave distortion.

Distortion in the AC sine wave powering micro processor controlled electronics can not only affect the performance of those electronics, but it can even damage them.

The inverter series is able to output a sine wave with a distortion ratio of less than 2.5%, equivalent to household electricity. A requirement of sensitive electronics with microprocessors.

The inverter series, controlled by a 16-bit microcomputer, is a Pulse Width Modulation (PWM) sine wave inverter, which means the generator's output frequency remains unchanged even when the engine speed varies and both the output voltage and the sine wave are very stable.

When fitting out a customer with a new Yamaha Generator, remember the type of power required is just as important as the amount of power required.

Sizing a Generator

When selling a generator, it is important to select one that is capable of meeting the energy requirements of the customer. Match the rated output of the generator to the maximum anticipated power demand. Make a list of the appliances and devices or tools that you expect to operate, as well as the approximate power requirements for each device. Remember microprocessor controlled electronics will need the Inverter Series.

One of the easiest and most accurate ways to size a generator is by using the AmWatt® Hand-held Appliance Load Tester by Reliance (ACC-0SS58-40-44). The AmWatt® plugs in line with the 120V device and can handle up to 1875 watts or 15 A.

After making a list of the electronic devices the customer intends to use with the generator, and ensure the load tester selector switch is in the WATTS position.

Plug the device into the load tester. Then plug the load tester into a house hold outlet and record the WATTS used by the device. Remember, some devices such as an electric motor will require additional energy at start up, as the pictures on the right show. Be sure to record the highest reading during the load test to ensure the generator can meet the requirements.

If the device has a load over 1800 Watts or a load tester is not available, locating the device model identification tag can give an accurate required load for the device. Often times the identification tag will list the voltage and the amps required. When you multiply amps and volts, the result is the load in Watts. For the device in the bottom picture the load would be, $120V \times 2 A = 240 \text{ Watts}$.

If the actual load of the customer's devices cannot be measured or located, the charts in the back of this section can provide an estimate of the required output of a generator. Remember the charts are just typical requirements and the customers actual needs may be different.

Once the load of all the devices have been recorded add them all up for the total Watts requirement for the customer's needs. If any sensitive electronics are in the line up, choose a generator capable of meeting or exceeding the total Watts for the devices the customer intends to use from the Inverter Series. If sensitive electronics aren't going to be used, a generator from the Premium family can also be selected.

Finally, make sure you understand what is important to the customer. For example if they want a quiet model, try to select a generator with an "S" in the model name, such as a EF3000iS. If easy starting is a goal of the customer, select an electric start model. Electric start models contain an "E" toward the end of the model name like the EF12000DE.



Generators Point of Purchase Items

Creating an eye catching display can help you not only attract customers, but assist you in showing off the features and benefits of the Yamaha Generator line up.

Generator Banners can be ordered with your regular parts order. Page 11-23 contains more information



The Inverter Series is Perfect for sensitive electronics.



AmWatt® Load Tester makes sizing a snap.



Load Tester plugged in-line with the device



Small electric motor start up load.



Small electric motor continuous load.



Device Label listing input requirements.

- General Information
- Rigging Estimate Guide (Diagrams)
- Rigging Components
- Electrical Components
- Engine Accessories
- Propellers
- Maintenance Items
- Oils & Lubes
- Detailing & Trailer Supplies
- Accessories & Apparel
- Generators & Accessories

Terms to Know

- Pulse Width Modulation** - Very clean and stable output with a waveform distortion ratio of 2.5% or less. This low distortion ratio means the output is cleaner than most commercial / residential power, making it safe to run sensitive computer equipment, televisions, and microchip-controlled power tools.
- Peak Output** - The amount of current that can be utilized for short time periods before the Thermal or Nonfuse Breakers (NFB) disconnects the output. This output level allows for jobs of short duration, requiring maximum output (tool startup).
- Rated Output** - The amount of current the generator can supply for continuous operation.
- 12 Volt DC Output** - The DC output is intended only to charge a 12-volt battery. If any 12-volt devices should be connected to a 12V battery and never to the 12V plug on the generator. It is possible that a device could be damaged if it is connected directly to a generator.
- Voltage and Frequency Standards** - In the U.S., standard commercial electricity is delivered at 110~120 V AC, and 220~240 V AC. The electrical frequency standard is 60 cycles per second (60 Hz).
- Electronic Breaker** - An electronic breaker circuit housed in the control unit of Yamaha Inverter generators. When output from the control unit exceeds a specific limit, output is automatically interrupted to protect the generator from damage.
- Thermal or No Fuse Breaker (NFB)** - Sometimes called a Non Fuse Breaker, this device acts like a fuse to interrupt power in the event of a sudden spike or surge in current. Unlike a fuse, however, the NFB can be reset.
- Smart-Throttle** - Because output frequency of an Inverter Generator is unrelated to engine rpm it becomes possible to utilize a wide range of engine rpm. This feature helps quiet running by choosing the minimum engine rpm necessary for the actual electrical load. A double coil system such as on the EF1000iS makes possible a higher output even at a low rpm setting. Smart Throttle ONLY applies to inverter models that have an electronic throttle servo motor to control engine speed.
- Economy Control (also called Economy Idle)** - Conventional generators, and in some cases inverter generators use economy control / idle. This function causes the unit to idle down when a load is not present.
- Ground Fault Interruption (GFI)** - Shuts down the power when a fault to ground is detected. A device that interrupts the power flowing through a GFI receptacle when a proper ground/earth ground is not present or a short were to take place - to prevent electrocution

Why Yamaha Generators

Electronics have become more a part of boating today than ever before. Almost every boat user could use a generator in one way or another. Whether it's for dock power, battery charging, to run appliances, or that beach party that was planned for weeks, boating customers need the convenience of a generator. With all the available generators on the market why would a customer want to buy Yamaha Generators?

Full Line of Accessories - Yamaha Generators offer a full line of accessories and optional parts, allowing customers to customize their generator to their needs. With other, commonly available generators, even if accessories are available they are mail order parts with no professional installation service available.

Yamaha Reliability - The same reliability that draws customers to Yamaha Outboards is available in every generator Yamaha offers. Just like an outboard, generators need to perform when the customer needs them. Worry free operation is a feature bargain branded generators can't offer.



Generator Overview

Inverter Series

As quiet, clean, and efficient as power gets. Yamaha Inverter technology is the way forward when it comes to light, quiet, clean, and portable power. Our high-quality inverter generators use Pulse Width Modulation to produce pure sine wave electricity. That means you have a source of electrical power that is as clean, or even cleaner, than municipal power so, unlike using cheap low quality generators, you can run computers and other electronic equipment with complete peace of mind. And Yamaha generators have advanced features to make them easy to live with and use. All models have an independent gasoline petcock, and on most models you'll find Noise Block™ technology for exceptionally quiet running as well as Smart Throttle™ for maximum fuel efficiency. With all these advantages, it will probably come as no surprise that many Yamaha generators also earn the longest engine durability rating from both the Environmental Protection Agency (EPA) and California Air Resources Board (CARB).



It's another way that Yamaha helps make your life easier, better, and brighter now and in the future.

Generators	EF1000iS	EF2000iS	EF2400iSHC	EF2800i	EF3000iS	EF3000iSEB	EF4500iSE	EF6300iSDE
Type	Brushless Inverter	Brushless Inverter	Brushless Inverter	Brushless Inverter	Brushless Inverter	Brushless Inverter	Brushless Inverter	Brushless Inverter
Rated Voltage	120V	120V	120V	120V	120V	120V	120V	120/240V
Frequency	60 Hz	60 Hz	60 Hz	60 Hz	60 Hz	60 Hz	60 Hz	60 Hz
Maximum AC Output	1000 watts	2000 watts	2400 watts	2800 watts	3000 watts	3000 watts+boost	4500 watts	6300 watts
Rated AC Output	900 watts	1600 watts	2000 watts	2500 watts	2800 watts	2800 watts	4000 watts	5500 watts
Maximum AC Current @ 120V	8.3 amps	16.7 amps	20 amps	23.3 amps	25 amps	25 amps	37.5 amps	52.5 amps
Maximum AC Current @ 240V	-	-	-	-	-	-	-	26.3 amps
Rated AC Current @ 120V	7.5 amps	13.3 amps	16.7 amps	20.8 amps	23.3 amps	23.3 amps	33.3 amps	45.8 amps
Rated AC Current @ 240V	-	-	-	-	-	-	-	22.9 amps
12 Volt DC Output	8 amps	8 amps	8 amps	8.3 amps	12 amps	12 amps	-	-
Type	OHV, Forced Air-Cooled, 4 Stroke, Single Cylinder							
Displacement	50cc	79cc	171cc	171cc	171cc	171cc	357cc	357cc
Ignition System	T.C.I.	T.C.I.	T.C.I.	T.C.I.	T.C.I.	T.C.I.	T.C.I.	T.C.I.
Starting System	Recoil w/Auto Decompression					Electric Start w/ Optional Wireless Remote		
Overall Length	17.7 in	19.3 in	20.8 in	19.2 in	26.8 in	26.8 in	30.7 in	30.7 in
Overall Width	9.4 in	11 in	16.5 in	15.6 in	17.5 in	17.5 in	24.3 in	24.3 in
Overall Height	14.9 in	17.9 in	18.2 in	16.7 in	21.9 in	21.9 in	27.2 in	27.2 in
Dry Weight	27.9 lbs	44.1 lbs	75 lbs	66 lbs	136 lbs	154.3 lbs	194 lbs	200 lbs
Fuel Tank Capacity	0.66 gal	1.1 gal	1.6 gal	2.6 gal	3.4 gal	3.4 gal	4.5 gal	4.5 gal
Continuous Operation Hours @ 1/4 Load	12 hr	10.5 hr	8.6 hr	15 hr	19 hr	19 hr	15.2 hr	13.3 hr
Noise Level	47 - 57 dBA	51.5 - 61 dBA	53 - 60 dBA	60 - 67 dBA	53 - 60 dBA	53 - 60 dBA	58 - 60 dBA	58 - 64 dBA
Limited Warranty	3 years	3 years	3 years	3 years	3 years	3 years	3 years	3 years
Wheels	-	-	Optional Four Wheel Kit	-	Four Wheels Standard	Four Wheels Standard	Four Wheels Standard	Four Wheels Standard
Optional Remote Starting	-	-	-	-	-	Wireless	Wireless	Wireless

Generators & Accessories

Yamaha power will be there when you need it. There's something to be said for experience. We've been building generators for more than 30 years now, and we've learned a few things along the way. Number one among them is that when you need power, you want the reliability of a Yamaha generator. Whatever your intended primary use, a big reason to own a generator is for emergency backup power at home. Advanced generator technology and features, quality materials and construction, and more than 30 years of doing things right add up to power that's there when you need it.



Generators	EF2600	EF5500D/ EF5500DE	EF7200D	EF7200DE	EF12000DE
Type	Brushless	Brushless	Brushless	Brushless	Brush
Rated Voltage	120V	120/240V	120/240V	120/240V	120/240V
Frequency	60 Hz	60 Hz	60 Hz	60 Hz	60 Hz
Maximum AC Output	2600 watts	5500 watts	7200 watts	7200 watts	12000 watts
Rated AC Output	2300 watts	4500 watts	6000 watts	6000 watts	9500 watts
Maximum AC Current @ 120V	21.6 amps	44 amps	60 amps	60 amps	100 amps
Rated AC Current @ 120V	19 amps	36 amps	50 amps	50 amps	79.2 amps
Maximum AC Current @ 240V	-	22.9 amps	30 amps	30 amps	50 amps
Rated AC Current @ 240V	-	18.75 amps	25 amps	25 amps	39.6 amps
Engine Type	OHV, Forced Air-Cooled, 4 Stroke, Single Cylinder				OHV, Forced Air-Cooled, 4 Stroke, Twin Cylinder
Engine Displacement	123cc	358cc	358cc	358cc	653cc
Ignition System	T.C.I.	T.C.I.	T.C.I.	T.C.I.	T.C.I.
Starting System	Recoil w/Auto Decompression	D Model - Recoil w/Auto Decompression DE Model - Electric Start with Recoil Back Up	Recoil w/Auto Decompression	Electric Start and Recoil w/Auto Decompression	Electric Start
Overall Length	20.1 in	31.5 in	31.5 in	31.5 in	33.3 in
Overall Width	16.3 in	28.4 in	28.4 in	28.4 in	29.6 in
Overall Height	16.7 in	29.1 in (handle down)	29.1 in (handle down)	29.1 in (handle down)	33.3 in
Dry Weight	92.6 lb	D 221.7 / DE 243.7	221.7 lbs	245.7 lbs	327.8 lbs
Fuel Tank Capacity	2.9 gal	6.9 gal	6.9 gal	6.9 gal	11.4 gal
Continuous Operation @ Rated Load	7.8 hr	9.0 hr	8.0 hr	8.0 hr	8.0 hr
Noise Level	68 dBA	74.1 dBA	74.5 dBA	74.5 dBA	80 dBA
Limited Warranty	3 years	3 years	3 years	3 years	3 years
Wheels	-	Two Wheel Kit	Two Wheel Kit	Two Wheel Standard	Four Wheels Standard
Optional Remote Starting	-	Wired Remote	Wired Remote	Wired Remote	Wired Remote

Inverter Series

EF1000iS



There's no excuse to be caught without power when the 28-pound, easy-to-carry EF1000iS is so easy to own. The EF1000iS is so compact and unobtrusive you'll enjoy using it almost anywhere: Noise Block design technology keeps it nice and quiet. And it's so efficient, thanks to Smart Throttle, that this little generator will run up to 12 hours on just 0.66 gallon of gas—easily powering up small appliances, computers, TVs and satellite systems with clean power from Yamaha's Pulse Width Modulation Inverter system. It even comes with cables for recharging 12-volt batteries.

The EF1000iS is ideal for:

- *Charging Batteries*
- *Small Electronics*
- *Emergency Power with Limited Space*

EF1000iS Quick Specs

Type	Brushless Inverter
Rated Voltage	120V
Frequency	60 Hz
Maximum AC Output	1000 watts
Rated AC Output	900 watts
Maximum AC Current	8.3 amps @ 120V
Rated AC Current	7.5 amps @ 120V
DC Output	12 volt 8 amps
Displacement	50cc
Ignition System	T.C.I.
Starting System	Recoil
Overall Length	17.7 in
Overall Width	9.4 in
Overall Height	14.9 in
Dry Weight	27.9 lb
Fuel Tank Capacity	0.66 gal
Continuous Operation Hours @ Load	12 hr @ 1/4 load
Noise Level	47-57 dBA
Limited Warranty	3 years*

*3 years Limited Warranty (except commercial/rental use = 2 year limited warranty)

EF1000iS Accessories and Maintenance Parts

Cover	ACC-GNCVR-10-BK
Wheel Kit	-
Wireless Remote Control	-
Twin Tech Cable	-
Sidewinder™ Cable	-
Hour Meter	ENG-METER-2C-01
Hour Meter / Tachometer	ENG-METER-4C-01
Charge Lead	7LG-87209-00-00
Spark Plug	CR4-HSB00-00-00
Air Filter	7VV-14451-00-00

General Information

Rigging Estimate Guide (Diagrams)

Rigging Components

Electrical Components

Engine Accessories

Propellers

Maintenance Items

Oils & Lubes

Detailing & Trailer Supplies

Accessories & Apparel

Generators & Accessories

EF2000iSv2 EF2000iSHv2



EF2000iSv2

EF2000iSHv2

The ingenious EF2000iSv2 is powerful, portable, and retrocool. It delivers maximum output with minimum effort. Weighing a mere 44 compact pounds, it features an extra large handle for easy transport to your campsite, work site, fishing spot—almost anywhere. Fitted with Yamaha's most technologically sophisticated muffler, it's whisper quiet. And if you need extra juice, the EF2000iSv2 has you covered—a convenient parallel function lets you connect two generators to deliver up to 30 maximum amps. Meets U.S. and CARB environmental standards; it's the way to power up responsibly.

The EF2000iSv2 / EF2000iSHv2 is ideal for:

- *Charging Batteries*
- *Small Electronics*
- *Emergency Power with Limited Space*



EF2000iSv2 / EF2000iSHv2 Accessories and Maintenance Parts

Cover	ACC-GNCVR-20-01
Wheel Kit	-
Wireless Remote Control	-
Twin Tech Cable (L5-30)	7PB-YH579-10-00
Sidewinder™ Cable (30 A RV)	ACC-0SS55-70-01
Hour Meter	ENG-METER-2C-01
Hour Meter / Tachometer	ENG-METER-4C-01
Charge Lead	7LG-87209-00-00
Spark Plug	BPR-6HS00-00-00
Air Filter	7DX-E4451-00-00

EF2000iSv2 / EF2000iSHv2 Quick Specs

Type	Brushless Inverter
Rated Voltage	120V
Frequency	60 Hz
Maximum AC Output	2000 watts
Rated AC Output	1600 watts
Maximum AC Current	16.7 amps @ 120V
Rated AC Current	13.3 amps @ 120V
DC Output	8 amps @ 12V
Displacement	79cc
Ignition System	T.C.I.
Starting System	Recoil
Overall Length	19.3 in
Overall Width	11 in
Overall Height	17.9 in
Dry Weight	44.1 lb
Fuel Tank Capacity	1.1 gal
Continuous Operation Hours @ Load	10.4 hr @ 1/4 load
Noise Level	51.5-61 dBA
Limited Warranty	3 years limited warranty

EF2400iSHC



EF2400iSHC Accessories and Maintenance Parts	
Cover	ACC-GNCVR-24-BK
Wheel Kit	ACC-GNWHL-24-00
Wireless Remote Control	-
Twin Tech Cable	-
Sidewinder™ Cable	-
Hour Meter	ENG-METER-2C-01
Hour Meter / Tachometer	ENG-METER-4C-01
Charge Lead	7LG-87209-00-00
Spark Plug	BPR-4ES00-40-00
Air Filter	7CN-E4451-00-00

The EF2400iSHC. HC stands for High Current, which means extra power to help start your motor-driven electric devices. This model uses Yamaha's powerful 171cc overhead-valve engine, contains all the latest Yamaha Inverter technology and puts out 2400 maximum watts of clean, pure power—enough juice to crank up a high-efficiency 13,500 BTU RV air conditioner. All in a package that weighs a mere 75 pounds! Which means the new EF2400iSHC is not only super quiet, but highly portable as well.

The EF2400iSHC is ideal for:

- Air Conditioners
- Small Electronics / TV's
- Emergency Power with Limited Space

EF2400iSHC Quick Specs	
Type	Brushless Inverter
Rated Voltage	120V
Frequency	60 Hz
Maximum AC Output	2400 watts
Rated AC Output	2000 watts
Maximum AC Current	20 amps @ 120V
Rated AC Current	16.7 amps @ 120V
DC Output	8 amps @ 12V
Displacement	171cc
Ignition System	T.C.I.
Starting System	Recoil
Overall Length	20.8 in
Overall Width	16.5 in
Overall Height	18.2 in
Dry Weight	75 lb
Fuel Tank Capacity	1.6 gal
Continuous Operation Hours @ Load	8.6 hr @ 1/4 load
Noise Level	53-60 dBA
Limited Warranty	3 years limited warranty

General Information

Rigging Estimate Guide (Diagrams)

Rigging Components

Electrical Components

Engine Accessories

Propellers

Maintenance Items

Oils & Lubes

Detailing & Trailer Supplies

Accessories & Apparel

Generators & Accessories

EF2800i



There's a bunch of power and big-time features built into this compact 68-pound Inverter generator. Rated at 2800 maximum watts of output, this generator has an exceptional power output to weight ratio. Pulse Width Modulation produces high-quality, clean electricity that's ideal for powering computers and electronic appliances. Other features include AC and DC output, Smart Throttle that matches engine speed to current draw for delivering optimal fuel economy, an Oil Watch Warning System and AC non-fuse thermal breaker circuitry and the list goes on. We're talking big, reliable power in a small package.

The EF2800i is ideal for:

- Air Conditioners
- Small Electronics / TV's
- Emergency Power with Limited Space

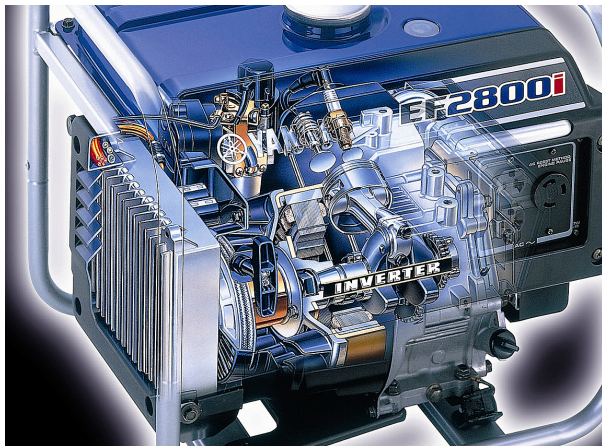

EF2800i Quick Specs	
Type	Brushless Inverter
Rated Voltage	120V
Frequency	60 Hz
Maximum AC Output	2800 watts
Rated AC Output	2500 watts
Maximum AC Current	23.3 amps @ 120V
Rated AC Current	20.8 amps @ 120V
DC Output	8.3 amps @ 12V
Displacement	171cc
Ignition System	T.C.I.
Starting System	Recoil
Overall Length	19.2 in
Overall Width	15.6 in
Overall Height	16.7 in
Dry Weight	68 lb
Fuel Tank Capacity	2.6 gal
Continuous Operation Hours @ Load	15 hr @ 1/4 load
Noise Level	64-67 dBA
Limited Warranty	3 years limited warranty

EF2800i Accessories and Maintenance Parts

Cover	ACC-GNCVR-26-BK
Wheel Kit	-
Wireless Remote Control	-
Twin Tech Cable	-
Sidewinder™ Cable	-
Hour Meter	ENG-METER-2C-01
Hour Meter / Tachometer	ENG-METER-4C-01
Charge Lead	7LG-87209-00-00
Spark Plug	BPR-4ES00-40-00
Air Filter	7CN-E4451-00-00

EF3000iS



Powerful and super-quiet, this recoil-start generator features Noise Block, our unique sound-reduction system that provides unbeatable noise dampening; Smart Throttle load-sensing rpm control that offers greater fuel efficiency and noise reduction by automatically adjusting engine speed to match the load; Inverter System with Pulse Width Modulation (PWM) control that lets you safely run products with built-in microcomputers, or microcomputer-controlled electric tools; plus Yamaha's unmatched quality with standard three-year limited warranty. All of which make it the best value in the 3000-watt class.

The EF3000iS is ideal for:

- Air Conditioners
- Small Electronics / TV's
- Emergency Power with Limited Space



EF3000iS Quick Specs

Type	Brushless Inverter
Rated Voltage	120V
Frequency	60 Hz
Maximum AC Output	3000 watts
Rated AC Output	2800 watts
Maximum AC Current	25 amps @ 120V
Rated AC Current	23.3 amps @ 120V
DC Output	12 amps @ 12V
Displacement	171cc
Ignition System	T.C.I.
Starting System	Recoil
Overall Length	26.8 in
Overall Width	17.5 in
Overall Height	21.9 in
Dry Weight	136 lb
Fuel Tank Capacity	3.4 gal
Continuous Operation Hours @ Load	19 hr @ 1/4 load
Noise Level	53-60 dBA
Limited Warranty	3 years limited warranty

EF3000iS Accessories and Maintenance Parts

Cover	ACC-GNCVR-30-01
Wheel Kit	-
Wireless Remote Control	ACC-GNRST-50-00
Twin Tech Cable	-
Sidewinder™ Cable	-
Hour Meter	ENG-METER-2C-01
Hour Meter / Tachometer	ENG-METER-4C-01
Charge Lead	-
Spark Plug	BPR-4ES00-40-00
Air Filter	7CP-E4451-00-00

General Information

Rigging Estimate Guide (Diagrams)

Rigging Components

Electrical Components

Engine Accessories

Propellers

Maintenance Items

Oils & Lubes

Detailing & Trailer Supplies

Accessories & Apparel

Generators & Accessories

EF3000iSEB



Get ready for clean, quiet power. Lots of it. Because the EF3000iSEB is one of the world's most technologically advanced inverter generators. It features Yamaha's performance enhancing features, including Inverter Technology, Noise Block, Smart Throttle, Pulse Width Modulation, Oil Watch Warning System (for preventing engine damage) and built-in wheels for smooth, easy portability. The EF3000iSEB offers an incredible 19-hour run time at one-quarter load. Plus, the EF3000iSEB goes one step further with Yamaha Boost Technology® for an extra boost of power to start up big air conditioners and heavy-duty power tools. It's the perfect choice for House Boats or travel trailers.

EF3000iSEB is ideal for:

- *Big Air Conditioners*
- *Small Electronics / TV's*
- *Heavy Duty Power Tools*

EF3000iSEB Accessories and Maintenance Parts	
Cover	ACC-GNCVR-30-01
Wheel Kit	-
Wireless Remote Control	ACC-GNRST-50-00
Twin Tech Cable	-
Sidewinder™ Cable	-
Hour Meter	ENG-METER-2C-01
Hour Meter / Tachometer	ENG-METER-4C-01
Charge Lead	-
Spark Plug	BPR-4ES00-40-00
Air Filter	7CP-E4451-00-00

EF3000iSEB Quick Specs	
Type	Brushless Inverter
Rated Voltage	120V
Frequency	60 Hz
Maximum AC Output	3000 watts
Rated AC Output	2800 watts
Maximum AC Current	25 amps @ 120V
Rated AC Current	23.3 amps @ 120V
DC Output	12 amps @ 12V
Displacement	171cc
Ignition System	T.C.I.
Starting System	Electric
Overall Length	26.8 in
Overall Width	17.5 in
Overall Height	21.9 in
Dry Weight	149.9 lb / 154.3lb
Fuel Tank Capacity	3.4 gal
Continuous Operation Hours @ Load	19 hr @ 1/4 load
Noise Level	53-60 dBA
Limited Warranty	3 years limited warranty

EF4500iSE



The EF4500iSE picks up where our extremely successful EF3000iSEB leaves off, with even more power and fuel efficiency in a quiet, portable package. Designed for maximum fuel efficiency and minimum noise, its super-powerful engine allows it to run at the very low engine speed of just 2600 rpm—1000 rpm lower than other generators in its class. That slow engine speed pays off big time in reduced fuel consumption as well as less noise, vibration and engine wear. Naturally, it's got all the advanced features you expect from Yamaha, including an optional wireless remote control. The EF4500iSE truly is the ultimate boat accessory.

The EF4500iSE is ideal for:

- *Big Air Conditioners*
- *Small Electronics / TV's*
- *Heavy Duty Power Tools*

EF4500iSE Accessories and Maintenance Parts	
Cover	ACC-GNCVR-45-BK
Wheel Kit	-
Wireless Remote Control	7XF-Y8600-00-00
Twin Tech Cable	-
Sidewinder™ Cable	-
Hour Meter	ENG-METER-2C-01
Hour Meter / Tachometer	ENG-METER-4C-01
Charge Lead	-
Spark Plug	BPR-4ES00-40-00
Air Filter	7CT-E4451-00-00

EF4500iSE Quick Specs	
Type	Brushless Inverter
Rated Voltage	120V
Frequency	60 Hz
Maximum AC Output	4500 watts
Rated AC Output	4000 watts
Maximum AC Current	37.5 amps @ 120V
Rated AC Current	33.3 amps @ 120V
DC Output	
Displacement	357cc
Ignition System	T.C.I.
Starting System	Electric
Overall Length	30.7 in
Overall Width	24.3 in
Overall Height	27.2 in
Dry Weight	194 lb
Fuel Tank Capacity	4.5 gal
Continuous Operation Hours @ Load	15.2 hr @ 1/4 load
Noise Level	58-60 dBA
Limited Warranty	3 years limited warranty

EF6300iSDE



Cranking out up to 6300 watts of pure sine wave inverter power, its fully enclosed casing makes it ultra quiet. And with sophisticated capabilities like dual 120-volt and 240-volt power, you can run almost any type of equipment with total confidence. From high-demand equipment such as well pumps, compressors and air conditioners to sensitive electronics like plasma TVs, satellite receivers and computers, the EF6300iSDE is ideal for outdoor recreation and power outage emergencies. Its excellent fuel efficiency means a run time of 13 hours at a constant one-quarter load on just a single tank of gas. Plus, its GFCI outlet and low noise level mean it's perfect for starting early or working late on the construction site making it the one workhorse you can't be without.

The EF6300iSDE is ideal for:

- *Big Air Conditioners*
- *Small Electronics / TV's*
- *Heavy Duty Power Tools*

EF6300iSE Accessories and Maintenance Parts	
Cover	ACC-GNCVR-45-01
Wheel Kit	-
Wireless Remote Control	7XF-Y8600-00-00
Twin Tech Cable	-
Sidewinder™ Cable	-
Hour Meter	ENG-METER-2C-01
Hour Meter / Tachometer	ENG-METER-4C-01
Charge Lead	-
Spark Plug	BPR-4ES00-40-00
Air Filter	7CT-E4451-00-00

EF6300iSE Quick Specs	
Type	Brushless Inverter
Rated Voltage	120/240V
Frequency	60 Hz
Maximum AC Output	6300 watts
Rated AC Output	5500 watts
Maximum AC Current	52.5 amps @ 120V 26.3 amps @ 240V
Rated AC Current	45.8 amps @ 120V 22.9 amps @ 240V
DC Output	
Displacement	357cc
Ignition System	T.C.I.
Starting System	Electric
Overall Length	30.7 in
Overall Width	24.3 in
Overall Height	27.2 in
Dry Weight	200 lb
Fuel Tank Capacity	4.5 gal
Continuous Operation Hours @ Load	13.3 hr @ 1/4 load
Noise Level	58-64 dBA
Limited Warranty	3 years limited warranty

EF2600



Rugged, lightweight and feature-packed, the EF2600 is an excellent compact generator for the home or work site, with the power to run many appliances as well as power tools. Compact and only 92.6 pounds, our smallest Premium Generator nonetheless comes with a big 2.9-gallon fuel tank (with gauge) that provides 7.8 hours of run time on a single tank of gas, along with non-fuse thermal breaker circuitry. Our Oil Watch Warning System protects the EF2600's heavy-duty 171cc engine, and a rugged rollover frame protects the outside. A mechanical governor delivers consistent engine speed for smoother power, while rubber mounts and a quiet muffler keep the noise to a minimum.

The EF2600 is ideal for:

- Power Tools
- Small appliances
- Air Conditioners

EF2600 Accessories and Maintenance Parts	
Cover	ACC-GNCVR-26-BK
Wheel Kit	-
Wireless Remote Control	-
Twin Tech Cable	-
Sidewinder™ Cable	-
Hour Meter	ENG-METER-2C-01
Hour Meter / Tachometer	ENG-METER-4C-01
Charge Lead	-
Spark Plug	BPR-4ES00-40-00
Air Filter	7CN-E4451-00-00

EF2600 Quick Specs	
Type	Brushless AC Generator
Rated Voltage	120V
Frequency	60 Hz
Maximum AC Output	2600 watts
Rated AC Output	2300 watts
Maximum AC Current	21.6 amps @ 120V
Rated AC Current	19 amps @ 120V
DC Output	
Displacement	171cc
Ignition System	T.C.I.
Starting System	Recoil
Overall Length	20.1 in
Overall Width	16.3 in
Overall Height	16.7 in
Dry Weight	92.6 lb
Fuel Tank Capacity	2.9 gal
Continuous Operation Hours @ Load	7.8 hr @ rated load
Noise Level	68 dBA
Limited Warranty	3 years limited warranty

General Information

Rigging Estimate Guide (Diagrams)

Rigging Components

Electrical Components

Engine Accessories

Propellers

Maintenance Items

Oils & Lubes

Detailing & Trailer Supplies

Accessories & Apparel

Generators & Accessories

EF5500D & EF5500DE



Go ahead and power up both 120- and 240-volt equipment with either of these new compact and powerful generators. anything from air conditioners to power drills. A rugged 358cc Yamaha engine has no trouble spinning out 5500 watts of power from the maintenance free brushless alternator, and they've got all the perks, too: Transistor Controlled Ignition helps them fire right up and run super smooth; Noise Suppressor reduces interference with TVs and radios; Oil Watch Warning System prevents engine damage; and Economy Idle reduces fuel consumption and noise. Plus, the EF5500D/DE adds the convenience of push-button electric start! Whichever one you choose, they're each perfect for the dock, Boat, and home backup.

EF5500D/DE Quick Specs

Type	Brushless Inverter
Rated Voltage	120V
Frequency	60 Hz
Maximum AC Output	5500 watts
Rated AC Output	5500 watts
Maximum AC Current	44 amps @ 125V
Rated AC Current	22.9 amps @ 240V
DC Output	
Displacement	358cc
Ignition System	T.C.I.
Starting System	Electric
Overall Length	31.5 in
Overall Width	28.4 in
Overall Height	29.1 in
Dry Weight	D= 212 lb, DE= 234 lb
Fuel Tank Capacity	6.9 gal
Continuous Operation Hours @ Load	9.0 hr @ load
Noise Level	74.1 dBA
Limited Warranty	3 years limited warranty

EF7200D & EF7200DE



Go ahead and power up both 120- and 240-volt equipment with either of these new compact and powerful generators—anything from air conditioners to power drills. A rugged 358cc Yamaha engine has no trouble spinning out 6000 watts of power from the maintenance free brushless alternator, and they've got all the perks, too: Transistor Controlled Ignition helps them fire right up and run super smooth; Noise Suppressor reduces interference with TVs and radios; Oil Watch Warning System prevents engine damage; and Economy Idle reduces fuel consumption and noise. Plus, the EF7200DE adds the convenience of push-button electric start! Whichever one you choose, they're each perfect for the dock, Boat, and home backup.

EF7200D / EF7200DE Quick Specs

Type	Brushless AC Generator
Rated Voltage	120/240V
Frequency	60 Hz
Maximum AC Output	7200 watts
Rated AC Output	6000 watts
Maximum AC Current	60 amps @ 120V 30 amps @ 240V
Rated AC Current	50 amps @ 120V 25 amps @ 240V
DC Output	
Displacement	358cc
Ignition System	T.C.I.
Starting System	Recoil / Electric
Overall Length	29.1 in
Overall Width	28.4 in
Overall Height	31.5 in
Dry Weight	212 lb / 234 lb
Fuel Tank Capacity	6.9 gal
Continuous Operation Hours @ Load	8.0 hr @ rated load
Noise Level	74.5 dBA
Limited Warranty	3 years limited warranty

EF12000DE



Power hungry? Just cut to the chase, and wheel in our most powerful generator: 12,000 watts should be enough to satisfy whatever you need to power up—120 or 240 volts. The EF12000DE's brush-type AVR AC alternator draws its motivation from a powerful, reliable 653cc twin-cylinder engine that'll run up to eight hours between fill-ups. We wouldn't send our flagship out there without the full complement of features: Oil Watch Warning System, Auto Voltage Regulation, Transistor Controlled Ignition, Noise Suppressor, GFI, Electric Starting and Economy Idle—you name it, this powerful generator's got it.

EF12000DE Accessories and Maintenance Parts

Cover	-
Wheel Kit	-
Remote Start Kit	7VW-Y8720-00-00
Wireless Remote Control	-
Twin Tech Cable	-
Sidewinder™ Cable	-
Hour Meter	ENG-METER-2C-01
Hour Meter / Tachometer	ENG-METER-4C-01
Charge Lead	-
Spark Plug	BPR-5ES00-00-00
Air Filter	YA2-63326-10-A1
Oil Filter	YA2486580110

EF12000DE Quick Specs

Type	Brush, AVR AC Generator
Rated Voltage	120/240V
Frequency	60 Hz
Maximum AC Output	12000 watts
Rated AC Output	9500 watts
Maximum AC Current	79.2 amps @ 120V 39.6 amps @ 240V
Rated AC Current	100 amps @ 120V 50 amps @ 240V
DC Output	
Displacement	653cc
Ignition System	T.C.I.
Starting System	Electric
Overall Length	33.3 in
Overall Width	29.6 in
Overall Height	33.3 in
Dry Weight	327.8 lb
Fuel Tank Capacity	11.4 gal
Continuous Operation Hours @ Load	8 hr @ rated load
Noise Level	80 dBA
Limited Warranty	3 years limited warranty

Pressure Washers

PW3028



3000 p.s.i of Pure Cleaning Power. Dependable 192cc 4-stroke, OHV, air-cooled engine from the name you know you can trust. Delivers 3000 psi and 2.8 GPM to get the job done quickly.

PW3028 Quick Specs

Length	24 in
Width	26 in
Weight	96 lb
Height - handle up/ handle down	41.5 in / 25 in
Gas tank capacity	1.5 gal
Run time	1.5 - 2 hr
Tires	Never flat 13 x 5 x 6
Limited Warranty	3 year / 1 year Commercial or Rental



PW3028 Accessories and Maintenance Parts

Nozzle Kit	ACC-31055-00-13
Gutter Cleaner	ACC-31051-00-13
Garden Hose Adapter	ACC-31054-00-13
Surface Cleaner	ACC-31056-00-13
Wand Extension	ACC-31053-00-13
Steel Braided Hose	ACC-31057-00-13
Turbo Nozzle	ACC-31048-00-13
Replacement Wand	ACC-31049-00-13
CAT Pumps® Oil	ACC-31045-00-13
Pressure Washer Pump Protector	ACC-31050-00-13

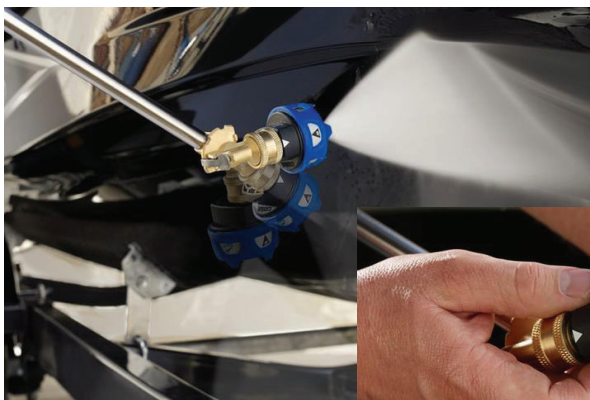

PW4040



4000 p.s.i of Pure Cleaning Power. Industrial grade 357cc 4-stroke, OHV, air-cooled engine from Yamaha. Delivers 4000 psi and 4.0 GPM to get tough jobs done quickly.

PW4040 Quick Specs

Length	26 in
Width	29 in
Weight	171 lb
Height - handle up/ handle down	42 in / 24 in
Gas tank capacity	1.61 gal
Run time	2 hr- 2.5 hr
Tires	Never flat 12 x 4
Limited Warranty	3 year / 1 year Commercial or Rental



PW3028 Accessories and Maintenance Parts

Nozzle Kit	ACC-31055-00-13
Gutter Cleaner	ACC-31051-00-13
Garden Hose Adapter	ACC-31054-00-13
Surface Cleaner	ACC-31056-00-13
Wand Extension	ACC-31053-00-13
Steel Braided Hose	ACC-31057-00-13
Turbo Nozzle	ACC-31048-00-13
Replacement Wand	ACC-31049-00-13
CAT Pumps® Oil	ACC-31045-00-13
Pressure Washer Pump Protector	ACC-31050-00-13



General Information

Rigging Estimate Guide (Diagrams)

Rigging Components

Electrical Components

Engine Accessories

Propellers

Maintenance Items

Oils & Lubes

Detailing & Trailer Supplies

Accessories & Apparel

Generators & Accessories

Water Pumps

Quick Specs	YP20G	YP30G	YP20T	YP30T	YP40T
Pump Type	Self-priming, Centrifugal	Self-priming, Centrifugal	Self-priming, Centrifugal	Self-priming, Centrifugal	Self-priming, Centrifugal
Caliber	2 in	3 in	2 in	3 in	4 in
Discharge Capacity	169 gal/ min	259 gal/ min	184 gal/ min	356 gal/ min	449 gal/ min
Self Priming Time	120 secs @ 16 ft	180 secs @ 18 ft	100 secs @ 26.25ft	100 secs @ 26.25ft	200 secs @ 26.25 ft
Total Head	88.7 ft	101.7 ft	92 ft	79 ft	89 ft
Suction Head	62 ft	75 ft	26 ft	26 ft	26 ft
Engine	171cc	171cc	175cc	296cc	357cc
Fuel Capacity	1.18 gal	1.9 gal	4 gal	5.5 gal	5.5 gal
Overall Length	15.6 in	15.6 in	26.18 in	26.97 in	30.1 in
Overall Width	20.4 in	20.4 in	18.19 in	19.88 in	21.4 in
Overall Height	19.3 in	19.3 in	20.31 in	21.85 in	24.6 in
Dry Weight	64 lb	66.1 lb	105 lb	138 lb	174 lb
Limited Warranty	3 years*	3 years*	3 years*	3 years*	3 years*

*3 years Limited Warranty (except commercial/rental use = 1 years limited warranty)

YP20G

The YP20G uses a 171cc, OHV 4-stroke engine that is quieter, more powerful, and consumes less fuel than comparable engines. Pumps up to 169 gal/min (10,140 gal/hr) through a two-inch port. Impeller and volute case are cast iron for greater strength and durability; and they withstand wear from grit, sand, silt, etc. Standard National Pipe Thread (NPT) fittings connect easily with the suction and discharge hoses. Automatic oil warning system shuts off before oil level is low to prevent catastrophic damage to the engine.

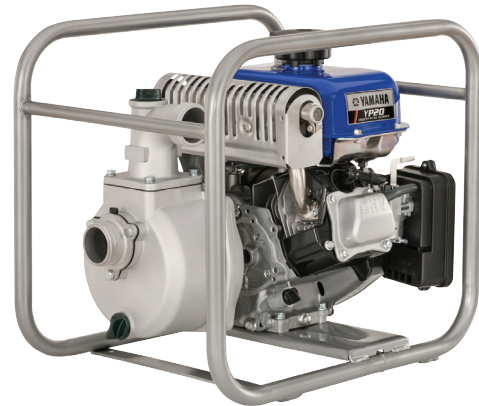

YP30G

The YP30G uses a 171cc, OHV 4-stroke engine that is quieter, more powerful, and consumes less fuel than comparable engines. Pumps up to 259 gal/min (15,540 gal/hr) through a three-inch port and delivers up to 102 feet of total head, 26 feet of suction head. Impeller and volute case are cast iron for greater strength and durability; and they withstand wear from grit, sand, silt, etc. Dependable carbon-ceramic mechanical seals are durable, easy to replace and they reduce abrasion for long pump life. Standard National Pipe Thread (NPT) fittings connect easily with the suction and discharge hoses.

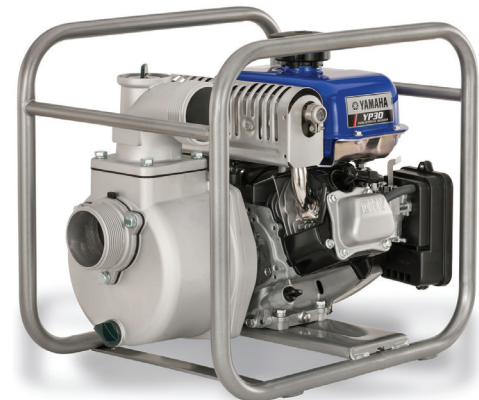



YP20T

The YP20T uses a 175cc, OHV 4-stroke engine that is quieter, more powerful, and consumes less fuel than comparable engines. It has a powerful pump, pumping up to 184 gal/min (11,040 gal/hr) through a two-inch port and delivering a 92-foot total head, with a 26-foot suction head. The pump can handle solids up to .79" (20 mm). With this durable pump, impeller and volute case are cast iron for greater strength and durability, they withstand wear from grit, sand, silt, etc. With an outstanding seal durability, a newly adopted Japanese-made silicone carbide (SIC) seal that has better durability compared to conventional carbon ceramic seals. This pump contains 2-inch standard National Pipe Thread (NPT) fittings that connect easily with the suction and discharge hoses. It comes with a 3 year industrial and residential limited warranty with optional Y.E.S. for customer peace of mind.



YP30T

The YP30T uses a 296cc, OHV 4-stroke engine that is quieter, more powerful, and consumes less fuel than comparable engines. YP30T delivers a 79-foot total head, with a 26-foot suction head and can handle solids up to 1 1/16" (27 mm). It has a Durable Pump - Impeller and volute case are cast iron for greater strength and durability; and they withstand wear from grit, sand, silt, etc. Outstanding Seal Durability - Newly adopted Japanese-made silicone carbide (SIC) seal - has better durability compared to conventional carbon ceramic seals. 3-inch Standard National Pipe Thread (NPT) fittings connect easily with the suction and discharge hoses. YP30T has a 3 year industrial and residential limited warranty with optional Y.E.S. for customer peace of mind.

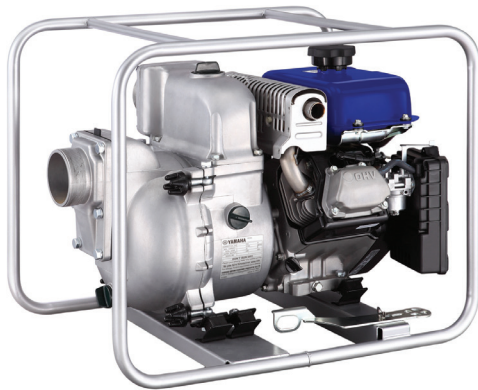

YP40T

The YP40T is ideal for dewatering applications such as job site excavations, mining sites, lakes, ponds and barge holds. The pump has the capability to move massive amounts of water at 26,940 gal/hr. Has an automatic oil warning shut off before oil level is low to avoid costly repairs and down time. Additional 1, 2 or 3 years of Y.E.S. is available.

Quick Specs	SP20E	SP20ESM	SP20ET
Pump Type	Dewatering Electric Submersible	Dewatering Electric Submersible	Dewatering Electric Submersible Trash
Discharge Head	33 ft.	33 ft.	33 ft.
Discharge Size	2 in	2 in	2 in
Discharge Style	Side	Top or Side	Side
Discharge Capacity	79 gal/ min	68.5 gal/ min	79.3 gal/ min
Voltage	120	120	120
Rated Current	7 amp	6.4 amp	7 amp
Motor Output	1/2 hp	1/2 hp	1/2 hp
Wattage Draw Start Up	2000	2000	2000
Running Wattage	840	768	840
Power Cord Length	20 ft.	20 ft.	20 ft.
Overall Length	10 in	8 in	10 in
Overall Width	10 in	8 in	10 in
Overall Height	15 in	13 in	17 in
Dry Weight	29 lb	24 lb	33 lb
Limited Warranty	2 years limited	2 years limited	2 years limited

SP20E

The SP20E is a small but efficient 1/2 hp electric pump made of heavy duty cast iron. SP20E is equipped with a 2-inch side discharge that can move 79 gallons per minute while only weighing 29 pounds. SP20E is protected with double mechanical seals and thermal protection. SP20E has a 20 ft. power cord with a uni-body construction to ensure water tightness.



SP20ESM

The SP20ESM is a small but efficient 1/2 hp electric pump made with durable blended rubber impeller and casing. SP20ESM is equipped with a 2-inch side or top/side discharge that can move 68.5 gallons per minute while only weighing 24 pounds. SP20ESM is protected with double mechanical seals and thermal protection. SP20ESM has a 20 ft. power cord with a uni-body construction to ensure water tightness.



SP20ET

The SP20ET is a small but efficient 1/2 hp electric pump made with heavy duty cast iron. SP20ET is equipped with a 2-inch side discharge that can move 79.3 gallons per minute while only weighing 33 pounds. SP20ET can handle solids up to 5/8" including leaves and sewage. SP20ET is protected with double mechanical seals and thermal protection. SP20ET has a 20 ft. power cord with a uni-body construction to ensure water tightness.



Generator Accessories

A full line of generator accessories is another great reason customers want Yamaha. With other brands bought at department stores and other chain stores accessories, if they're offered, are available through the mail with no personalized service to ensure your customer gets the parts they need. For a quick overview of some of the many accessories available for Yamaha Generators, see the charts below.

Inverter Series

	Cover	Wireless Remote	Hour Meter	Hour Meter / Tachometer
EF1000iS	ACC-GNCVR-10-BK	-	ENG-METER-2C-01	ENG-METER-4C-01
EF2000iS	ACC-GNCVR-20-BK	-	ENG-METER-2C-01	ENG-METER-4C-01
EF2400iSHC	ACC-GNCVR-24-BK	-	ENG-METER-2C-01	ENG-METER-4C-01
EF2800i	ACC-GNCVR-26-BK	-	ENG-METER-2C-01	ENG-METER-4C-01
EF3000iSEB	ACC-GNCVR-30-BK	ACC-GNRST-50-00	ENG-METER-2C-01	ENG-METER-4C-01
EF4500iSE	ACC-GNCVR-45-BK	7XF-Y8600-00-00	ENG-METER-2C-01	ENG-METER-4C-01
EF6300iSDE	ACC-GNCVR-45-BK	7XF-Y8600-00-00	ENG-METER-2C-01	ENG-METER-4C-01



Wheel Kits

	Wheel Kit	Twin Tech Cable	Sidewinder™ Cable
EF1000iS	-	-	-
EF2000iS		7PB-YH579-10-00	ACC-OSS55-70-01
EF2400iSHC	ACC-GNWHL-24-00	-	-
EF2800i	-	-	-
EF3000iSEB	-	-	-
EF4500iSE	-	-	-
EF6300iSDE	-	-	-



Generator Covers

Premium Series

	Cover	Wheel Kit	Remote Start Cable	Hour Meter	Hour Meter / Tachometer
EF2600	ACC-GNCVR-26-BK	-	-	ENG-METER-2C-01	ENG-METER-4C-01
EF5500D	ACC-GNCVR-55-BK	-	-	ENG-METER-2C-01	ENG-METER-4C-01
EF5500DE	ACC-GNCVR-55-BK	-	7VW-Y8720-00-00	ENG-METER-2C-01	ENG-METER-4C-01
EF7200D	ACC-GNCVR-55-BK	-	-	ENG-METER-2C-01	ENG-METER-4C-01
EF7200DE	ACC-GNCVR-55-BK	-	7VW-Y8720-00-00		
EF12000DE	-	-	7VW-Y8720-00-00	ENG-METER-2C-01	ENG-METER-4C-01



Remote Starter Kits

Generator Covers

Protect your investment during storage with a cover made from premium Sur Last® polyester fabric. This UV-resistant material fights fading while protecting your equipment from the elements. A special urethane coating lets moisture escape from underneath while remaining water repellent. The cover is mold and mildew resistant, as well as tear and abrasion resistant for durability.

Inverter Series	
Generator	Cover
EF1000iS	ACC-GNCVR-10-BK
EF2000iS	ACC-GNCVR-20-BK
EF2400iSHC	ACC-GNCVR-24-BK
EF2800i	ACC-GNCVR-26-BK
EF3000iS	ACC-GNCVR-30-BK
EF3000iSEB	ACC-GNCVR-30-BK
EF4500iSE	ACC-GNCVR-45-BK
EF6300iSDE	ACC-GNCVR-45-BK

Generator	Cover
EF2600	ACC-GNCVR-26-BK
EF5500D	ACC-GNCVR-55-BK
EF5500DE	ACC-GNCVR-55-BK
EF7200D	ACC-GNCVR-55-BK
EF7200DE	ACC-GNCVR-55-BK



ACC-GNCVR-10-BK



ACC-GNCVR-20-BK



ACC-GNCVR-24-BK



ACC-GNCVR-26-BK



ACC-GNCVR-30-BK



ACC-GNCVR-45-BK



ACC-GNCVR-55-BK

General Information

Rigging Estimate Guide (Diagrams)

Rigging Components

Electrical Components

Engine Accessories

Propellers

Maintenance Items

Oils & Lubes

Detailing & Trailer Supplies

Accessories & Apparel

Generators & Accessories



EF2400iSHC Four Wheel Kit

For ease of maneuverability, these wheel kits are ideal. Heavy-duty solid wheels to eliminate flats.

ACC-GNWHL-24-00



Wired Remote Starter Kits

Extra convenience for getting up and going when you need to. Features a 33-foot cord with remote starter switch. Available for all electric-start premium models.

7VW-Y8720-00-00

Fits EF12000DE

7PB-Y8720-A0-00

Fits EF5500DE/D, EF7200DE/D

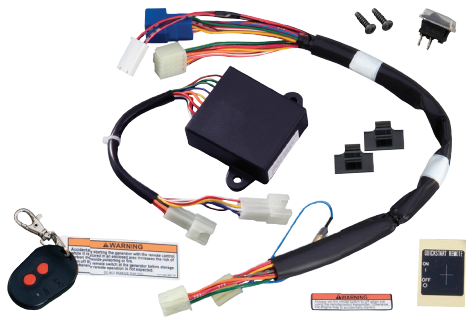

Wireless Remote Control Kit

Start your generator remotely with the wireless remote control kits. Just like remote start kit for automobiles, there is no need to face the elements to get the power of a Yamaha Generator flowing.

7XF-Y8600-00-00

Fits EF4500iSE and EF6300iSDE

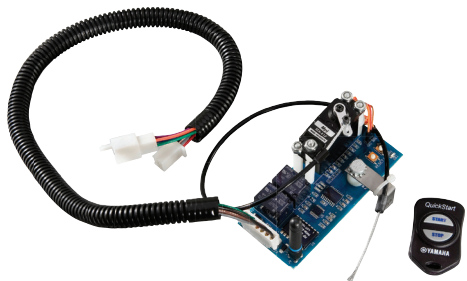

Wireless Remote Control Kit

Start your generator remotely with the wireless remote control kits. Just like remote start kit for automobiles, there is no need to face the elements to get the power of a Yamaha Generator flowing.

ACC-GNRST-50-00

Fits EF3000iSE/iSEB



Optional Parts for Wireless Remote Control Kit

ACC-GNRST-50-00

Replacement Key Fob Transmitter

ACC-GNRST-30-20

Optional External Antenna

ACC-GNRST-30-10

Sidewinder™ Parallel Power Cable

Combine the power of two Yamaha EF2000iS generators. Includes polarized IP30 banana plugs, quick connection to parallel jacks on both generators, color-coded wire leads, exclusive flexible tip construction that resists breakage, rugged over-braided cable design, and a handy Velcro® mounting system. Compatible with a standard 30A RV cord (plugs directly into all 30A RV cables). Works with a pair of EF2000iS generators.

ACC-0SS55-70-01



Twin Tech™ Cable

Connect two EF2000iS generators for max. 30 amps and rated 25 amps of power. Includes standard 30 amp twist-lock receptacle (NEMA® L5-30). Works with a pair of EF2000iS generators.

(For RV use, adaptor (ACC-RVADP-PL-UG) required, sold separately.)

Standard 30 Amp Cable **7PB-YH579-10-00**

RV 30 Amp Cable **7PB-YH579-70-00**



RV Adapter Kit

Plug has a 30A receptacle for RV use. Required if connecting the Twin Tech cable to RV.

ACC-RVADP-PL-UG



Yamaha Engine Meter

To help you maintain your generator at proper service intervals, the intervals are pre-programmed into this meter (10 hours initial, every 50 hours thereafter). Upon reaching the specified service interval, the meter displays a flash alert for a two-hour period. Works with all Yamaha gasoline generators and pumps.

Deluxe Hour Meter (Hour Meter Only): **ENG-METER-2C-01**

Deluxe Hour Meter & Tachometer: **ENG-METER-4C-01**



AM/WATT® Appliance Load Tester by Reliance Controls

Gives quick, accurate readout of watts or amps used by 120 volt AC electrical devices (1875 watts maximum) such as: refrigerators, dehumidifiers, space heaters, and much more. Has a 26" cord to reach remote electrical outlets. Easy amps/watts slide switch. Tester is perfect for matching appliance loads to generator power output.

ACC-0SS58-40-44



General Information

Rigging Estimate Guide (Diagrams)

Rigging Components

Electrical Components

Engine Accessories

Propellers

Maintenance Items

Oils & Lubes

Detailing & Trailer Supplies

Accessories & Apparel

Generators & Accessories

Pressure Washer and Accessories



Yamaha Turbo Nozzle

Cleans up to 50% faster than a standard nozzle. Delivers 0° rotating spray pattern for faster cleaning. Works with many gas-powered pressure washers up to 4200 psi.

ACC-31048-00-13

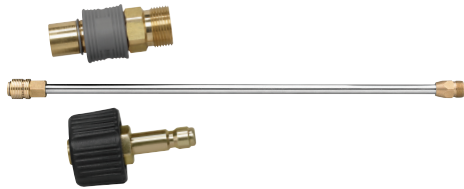

Yamaha Wand Extension Kit

Extend the length of your pressure washer wand 36" for easier reaching. Includes quick-connect adapter to transform any threaded nozzle into a quick-connect nozzle. Works with many gas-powered washers up to 4500 psi.

ACC-31053-00-13



Yamaha Replacement Wand

Ideal upgrade for old or worn out spray wands. Quick-connect capable for easy attaching of all quick-connect accessories. Works with many gas-powered washers up to 4500 psi.

ACC-31049-00-13



Yamaha Nozzle Kit

Includes 0°, 25°, 40°, Soap, and 800 psi nozzles for cleaning a variety of surfaces. Heavy-duty electropolish finish for more durability and longer performance life. Includes 800 psi nozzle for safe cleaning of delicate surfaces. Works with many gas-powered pressure washers up to 4500 psi.

ACC-31055-00-13

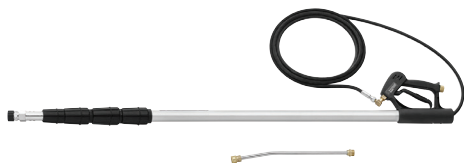

Yamaha Telescoping Pole

Adjustable height extends between 7 ~ 16.5'. Quick-connect capable for easy attaching. Angled wand tip for more direct contact with high surfaces.

Works with many gas-powered washers up to 4200 psi.

ACC-31044-00-13

Yamaha Gutter Cleaner

Fast and effective gutter cleaning. Two high-pressure water jets blast debris out and away. Directs debris and water away from the user for clean, dry operation. Quick-connect capable for easy attachment. Recommended for many gas-powered washers up to 3300 psi. Recommended for use with extension wands.

ACC-31051-00-13



Yamaha Garden Hose Adapter Kit

Quick-Connect adapter for your garden hose. Snap your garden hose directly into your pressure washer pump. Recommended for use with many gas-powered washers up to 4500 psi.

ACC-31054-00-13



Yamaha Surface Cleaner

Cleans large surfaces up to 4x faster than a standard nozzle. Rotating nozzles provide streakfree, even cleaning. 15" cleaning path for much faster cleaning. Attaches easily to any quick connect capable pressure washer. Recommended for many gas-powered washers up to 3300 psi.

ACC-31056-00-13



Yamaha Steel Braided Hose

Steel-braided construction for durability and long life. Quick-connect capable for easy attaching. 30 ft. for more reach than standard hoses. Links to existing hoses for longer reach. Recommended for many gas-powered washers up to 3300 psi.

ACC-31057-00-13



CAT Pumps® Oil

Premium Grade oil promotes better performance and longer pump life. Anti-corrosion technology keeps your pump conditioned and protected. Anti-wear stabilizers for reliable performance day after day.

ACC-31045-00-13



General Information

Rigging Estimate Guide (Diagrams)

Rigging Components

Electrical Components

Engine Accessories

Propellers

Maintenance Items

Oils & Lubes

Detailing & Trailer Supplies

Accessories & Apparel

Generators & Accessories

Generator Maintenance Parts

Yamaha offers a complete line of maintenance parts for generators, so why compromise the legendary Yamaha reliability with aftermarket parts.

	Oil Capacity	Oil Filter	Spark Plug	Battery	Air Filter
EF1000iS	0.34 US QT (0.32 L)	Not Required	CR4-HSB00-00-00	-	7VV-14451-00-00
EF2000iS	0.42 US QT (0.4 L)	Not Required	BPR-6HS00-00-00	-	7DX-E4451-00-00
EF2400iS/HC	0.63 US QT (0.6 L)	Not Required	BPR-4ES00-40-00	-	7CN-E4451-00-00
EF2800i	0.63 US QT (0.6 L)	Not Required	BPR-4ES00-40-00	-	7CN-E4451-00-00
EF3000iS/EB	0.63 US QT (0.6 L)	Not Required	BPR-4ES00-40-00	YTX-12BS0-00-00	7CP-E4451-00-00
EF4500iSE	1.14 US QT (1.3 L)	Not Required	BPR-4ES00-40-00	YTX-20LBS-00-00	7CT-E4451-00-00
EF6300iSDE	1.14 US QT (1.3L)	Not Required	BPR-4ES00-40-00	YTX-20LBS-00-00	7CT-E4451-00-00
EF2600	0.63 US QT (0.6 L)	Not Required	BPR-4ES00-40-00	-	7CN-E4451-00-00
EF5500D/DE	1.16 US QT (1.1 L)	Not Required	BPR-4ES00-40-00	YTX-14B-S0-00-00	7CT-E4451-00-00
EF7200D/DE	1.16 US QT (1.1 L)	Not Required	BPR-4ES00-40-00	YTX-14B-S0-00-00	7CT-E4451-00-00
EF12000DE	1.64 US QT (1.55 L)	YA2486580110	BPR-5ES00-00-00	<23° - NS6-00000-00-00 >24° - NS4-0Z000-00-00	YA2-63326-10-A1



Air & Oil Filters



7DX-E4451-00-00
EF2000iS



7VV-14451-00-00
EF1000iS



7CT-E4451-00-00
EF4500iSE, EF6300iSDE,
EF4000D(E), EF5200D(E),
EF6600D(E)



7CN-E4451-00-00
EF2400iS, EF2400iSHC,
EF2800i EF2600



7CP-E4451-00-00
EF3000i, EF3000iSE, EF3000iSEB



YA2-63326-10-A1
EF12000DE



YA2-48658-01-10
EF12000DE



7CP-E4451-00-00
EF3000iS/E/EB

General
Information

Rigging Estimate
Guide (Diagrams)

Rigging
Components

Electrical
Components

Engine
Accessories

Propellers

Maintenance
Items

Oils
& Lubes

Detailing &
Trailer Supplies

Accessories
& Apparel

Generators
& Accessories

Yamalube® Products



Foam Air Filter Oil

Helps protect against dirt, dust and water. For use only with foam air filters. Minimum order quantity is 4.

Pint Bottle: **ACC-FOAMF-LT-ER**



Bio-degradable Foam Air Filter Oil & Cleaner Kit

Kit contains a non-alcohol-based, dirt-grabbing, water resistant, super-tacky filter oil and heavy-duty, concentrated detergent, specifically developed to clean foam air filters. This Air Filter Oil can only be washed out with the Biodegradable Foam Air Filter Cleaner and water. It won't wash out with gasoline, solvents or water alone. Minimum order quantity is 12.

2 - 16 OZ Bottles: **ACC-BIFMF-LT-KT**



Air Filter Cleaner

Air Filter Cleaner is used to clean foam & fabric air filters that have been treated with petroleum based oil. Use this cleaner to clean filters treated with Yamalube Foam Filter oil. Minimum order quantity is 4.

Gallon Bottle: **ACC-FOAMF-CL-GL**



10W-30 Golf Car and Generator Oil

Specially formulated mineral base oil and additive system for the rigors of a constant load and frequent start-ups as found with the normal operation of a Golf Car or Generator.

Quart Bottles: **LUB-10W30-GG-12**

5 Gallon Bucket: **LUB-10W30-GG-05**

55 Gallon Drum: **LUB-10W30-GG-55**

Generator Wattage Application and Extension Cord Gauge Chart

APPLIANCES & TOOLS				
	Running Wattage Requirements	Starting Wattage Requirements	QTY	Totals
VCR	50	0		
Heating Pad	65	0		
Radio	100	0		
Television - Black & White	100	0		
Television - Color	300	0		
Dehumidifier	400	0		
Electric Blanket	400	0		
Garage Door Opener - 1/4HP	550	1100		
Garage Door Opener - 1/3HP	725	1400		
Well Pump - 1/3 hp	750	1400		
Well Pump - 1/2 hp	1000	2100		
Sump Pump - 1/3 hp	800	1300		
Sump Pump - 1/2 hp	1050	2150		
Vacuum Cleaner - Standard	800	0		
Vacuum Cleaner - Deluxe	1100	0		
1/4" Drill	300	300		
Jigsaw	300	300		
Electric Weed Trimmer	500	500		
Router	1000	1000		
Belt Sander	1000	1000		
Disc Sander	1200	1200		
Chain Saw	1200	1200		
Worm Drive Saw	1560	3100		
12" Concrete Cutter	1800	3600		
7 1/4" Circular Saw	1500			
Disc Grinder	2000	4000		
Air Compressor, Average	2000	4000		
APPLIANCES & TOOLS SUB TOTAL:				

LOAD (AMPS)	WIRE MINIMUM GAUGE (AWG)			LOAD (AMPS)	WIRE MINIMUM GAUGE (AWG)		
	0 ~ 50 ft.	51 ~ 100 ft.	101 ~ 150 ft.		0 ~ 50 ft.	51 ~ 100 ft.	101 ~ 150 ft.
				16	14	10	10
2	22	20	18	18	14	10	8
3	22	18	16	20	12	10	8
4	20	16	16	22	12	10	8
5	18	16	14	25	12	10	8
6	18	16	14	30	10	8	6
8	16	14	12	35	10	8	6
10	16	12	12	40	8	6	4
12	16	12	10	50	6	4	2
14	14	12	10	60	4	2	2

Generators & Accessories

General Information

Rigging Estimate Guide (Diagrams)

Rigging Components

Electrical Components

Engine Accessories

Propellers

Maintenance Items

Oils & Lubes

Detailing & Trailer Supplies

Accessories & Apparel

Generators & Accessories

KITCHEN & BATH				
	Running Wattage Requirements	Starting Wattage Requirements	QTY	Totals
Refrigerator, Average	600	2200		
Dish Washer - Cool Dry	700	1400		
Dish Washer - Hot Dry	1450	1400		
Clothes Dryer - Gas	700	1800		
Clothes Dryer - Electric	5750	1800		
Microwave Oven, 1000W	1500	1650		
Washing Machine	750	2300		
Coffee Maker	1000	0		
Toaster 2-slice	1100	0		
Toaster 4-slice	1650	0		
Electric Skillet	1500	0		
Electric Range 6-in. element	1500	0		
Electric Range 8-in. element	2100	0		
Freezer	2500	2200		
Hair Dryer 1500 watt	1500	0		
Iron	1200	0		
KITCHEN & BATH SUB TOTAL:				

HEATING & COOLING				
	Running Wattage Requirements	Starting Wattage Requirements	QTY	Totals
Furnace Fan, gas or fuel oil furnace				
1/8 horsepower	300	500		
1/6 horsepower	500	750		
1/4 horsepower	600	1000		
2/5 horsepower	700	1400		
3/5 horsepower	875	2350		
Central Air Conditioner				
10,000 BTU	1500	2200		
20,000 BTU	2500	3300		
24,000 BTU	3800	4950		
32,000 BTU	5000	6500		
40,000 BTU	6000	6700		
HEATING/COOLING SUB-TOTAL:				

MAINTENANCE MATTERS

*For Those Who Want
the Good Times To Last*

Reliability. It may start with a Yamaha, but it's sustained with proper care and maintenance. Yamaha offers everything customers need to keep their outboard and boat ready to run.

Regular maintenance is critical for the continued proper operation of any engine. Add in the fact that an outboard operates under some of the harshest environmental conditions imaginable, and maintenance becomes even more critical. High load, high-RPM operation, extreme temperatures, high moisture and periods of non-use all take a toll on an outboard. For these reasons, regular maintenance is vital for care free days on the water.

Remember, Maintenance Matters.



Boat smart from the start. Take a boating safety course and get a free vessel safety check annually for your boat. For more information, contact: United States Coast Guard Auxiliary online at www.cgaux.org or the United States Power Squadrons at 888-FOR-USPS or www.usps.org. Remember to always observe all applicable boating laws. Never drink and drive. Dress properly with a USCG approved personal flotation device and protective gear.

While every effort has been made to ensure accuracy of the information contained herein, specifications and measurements are approximations and subject to variances. Yamaha does not guarantee such accuracy and can't be held liable for any errors or any reliance upon this information.

This document contains many of the valuable trademarks and service marks owned by Yamaha throughout the world. The document may also contain references to other company, brand and product names that may be the trademarks/service marks of their respective owners. These companies, brand and product names are used herein for identification purposes only, and reference to any names, marks, products or services of third parties do not constitute or imply endorsement, sponsorship or recommendation of the third party or the products or services.

Availability subject to production, stocking, and demand. Current availability can be found using YMBS (www.yamaha-dealers.com/outboards).



LIT-MRPDC-AT-19

© 2019 Yamaha Motor Corporation, U.S.A. All rights reserved.



2019 Outboard Rigging and Parts