

Marine Catalog 2016

pumps and accessories for marine applications

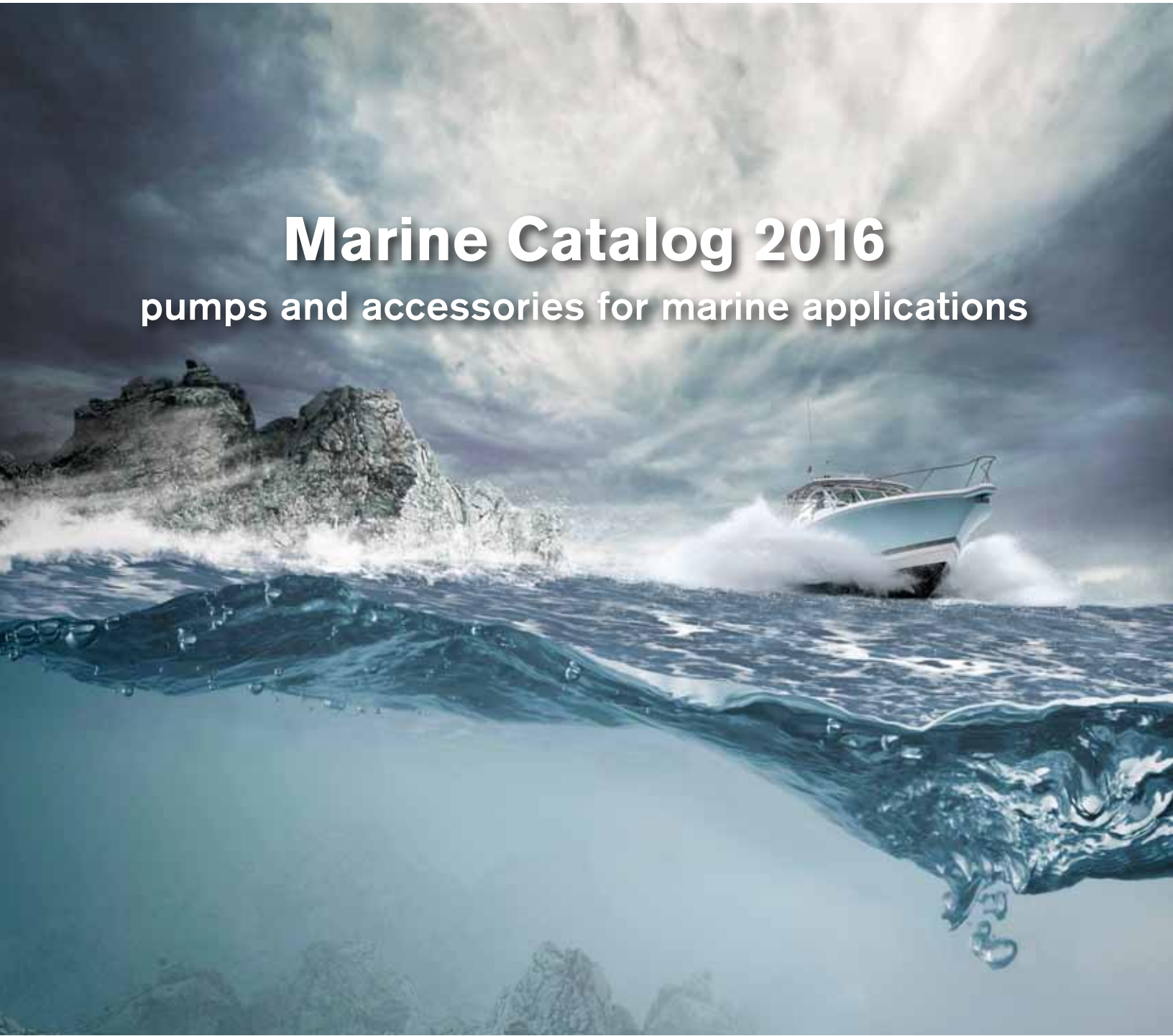

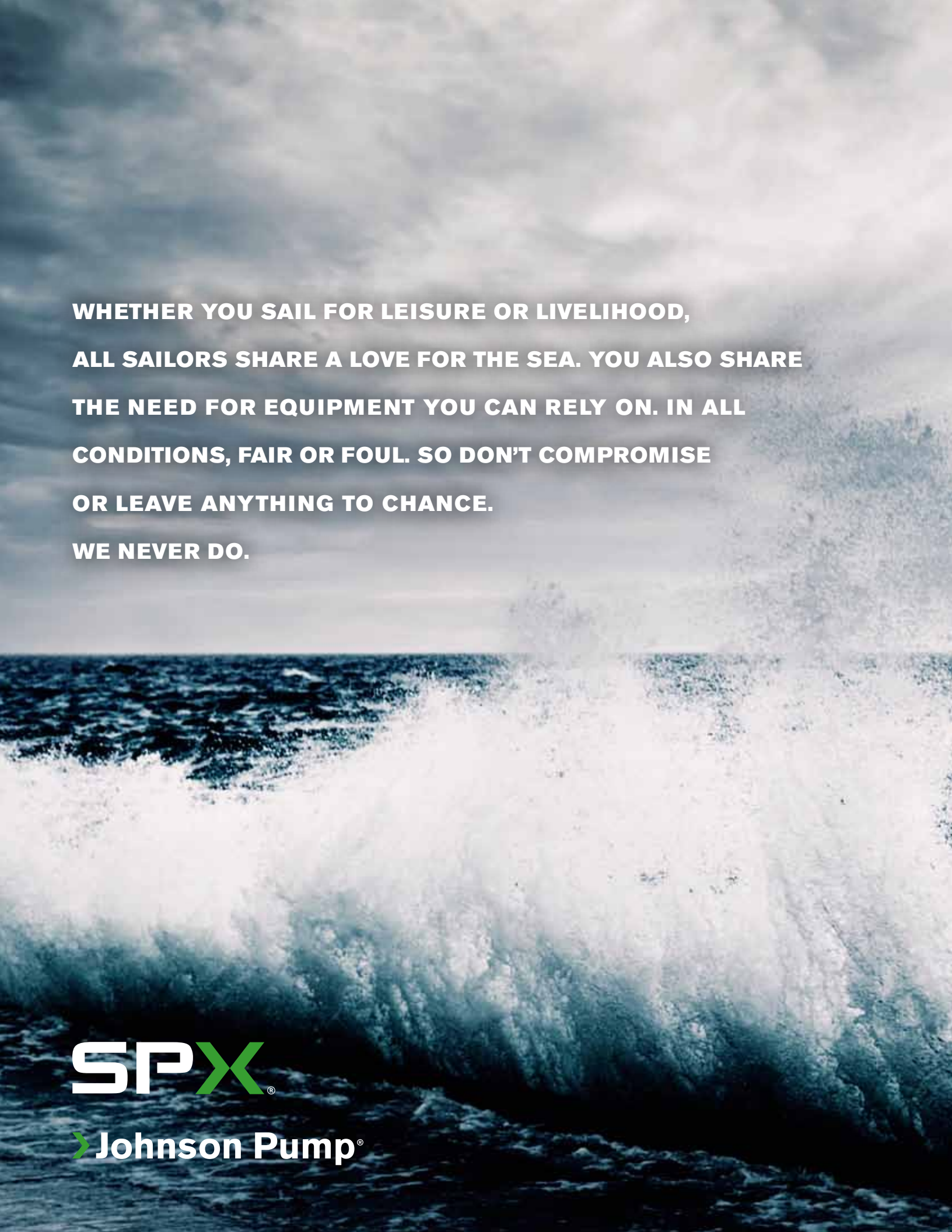

**WHETHER YOU SAIL FOR LEISURE OR LIVELIHOOD,
ALL SAILORS SHARE A LOVE FOR THE SEA. YOU ALSO SHARE
THE NEED FOR EQUIPMENT YOU CAN RELY ON. IN ALL
CONDITIONS, FAIR OR FOUL. SO DON'T COMPROMISE
OR LEAVE ANYTHING TO CHANCE.
WE NEVER DO.**

SPX[®]

› Johnson Pump[®]



CONTENTS

Water Pressure Systems & Wash Down Pumps	5
Heavy Duty Submersible Bilge Pumps	12
Fishing Livewell Pumps and Accessories	21
FIP DC Pumps	25
Circulation Pumps	28
Waste Water Handling & Marine Toilets	31
Radial Blowers & Marine Water Heaters	39
Impeller Pumps	43
Engine Cooling	49
Impeller Identification Guide	53
Tech Tools	56
Index	57

Reliability on board



No matter whether you are an experienced boater looking for a replacement pump or a manufacturer specifying pumps for your marine application, we are prepared to provide you with the support you need. And no matter where you work or live, access to our products, services, spare parts and support are never far away. In fact, you will find SPX's Johnson Pump Marine Brand represented in every major industrial country of the world today and in more than sixty nations altogether.





Water Pressure Systems & Wash Down Pumps



Quiet and pulsation-free even at low speeds, the Aqua Jet five chamber diaphragm pump provides the perfect water pressure or deck wash solution for both small and medium sized leisure and commercial boats. Efficient and compact, Aqua Jet pumps are particularly suitable where low amperage and sound levels in relation to water flow are placed at a premium - such as in shower and galley applications. Operates in fresh or sea water. Self priming.



CE marked according to following standards:

- EN55014: 1993/Radio disturbance
- ISO8846: 1990/Electrical devices – Protection against ignition of surrounding flammable gases
- ISO10133: 1994/Electrical systems – Extra-low voltage DC installations

AQUA JET WATER PRESSURE SYSTEMS

The five chamber Aqua Jet WPS-series provides a reliable heart for small boat and recreational vehicle water pressure systems. Compared to conventional three or four-chamber diaphragm pumps, the Aqua Jet demonstrates dramatically lower noise and water pulsation characteristics. It is recommended to install the WPS-pumps with an accumulator tank. Always use a PUMProtector inlet strainer before the pump intake.

WPS 2.4



Diaphragm	Santoprene	Weight	1.6 kg/3.5 lbs
Valves	EPDM	Length	204 mm/8.02"
Body	PP/PPA	Width	197 mm/7.76"
Motor	85W	Height	110 mm/4.33"

Order No.	Description	Capacity	Pressure Cut Off*	Fuse Size	Connection**
10-24604-103	Aqua Jet WPS 2.4, 12V	9 l/min – 2.4 GPM	2.8 bar – 41 psi	10 A	3/8" NPT / hose 1/2"; 1/2" NPT, 3/4" hose
10-24604-104	Aqua Jet WPS 2.4, 24V	9 l/min – 2.4 GPM	2.8 bar – 41 psi	5 A	3/8" NPT / hose 1/2"; 1/2" NPT, 3/4" hose

WPS 2.9



Diaphragm	Santoprene	Weight	1.6 kg/3.5 lbs
Valves	EPDM	Length	204 mm/8.02"
Body	PP/PPA	Width	197 mm/7.76"
Motor	85W	Height	110 mm/4.33"

Order No.	Description	Capacity	Pressure Cut Off*	Fuse Size	Connection**
10-13405-103	Aqua Jet WPS 2.9, 12V	11 l/min – 2.9 GPM	2.8 bar – 41psi	10 A	3/8" NPT / hose 1/2"; 1/2" NPT, 3/4" hose
10-13405-104	Aqua Jet WPS 2.9, 24V	11 l/min – 2.9 GPM	2.8 bar – 41psi	5 A	3/8" NPT / hose 1/2"; 1/2" NPT, 3/4" hose

WPS 3.5



Diaphragm	Santoprene	Weight	2 kg /4.5 lbs
Valves	EPDM	Length	236,5 mm/9.31"
Body	PP/PPA	Width	210 mm/8.25"
Motor	85W	Height	116 mm/4.575"

Order No.	Description	Capacity	Pressure Cut Off*	Fuse Size	Connection**
10-13395-103	Aqua Jet WPS 3.5, 12V	13L/min / 3.5 GPM	2.8 bar / 41psi	10 A	3/8" NPT / hose 1/2", 1/2" NPT / hose 3/4"; 1/2" NPT, 3/4" hose
10-13395-104	Aqua Jet WPS 3.5, 24V	13L/min / 3.5 GPM	2.8 bar / 41psi	5 A	3/8" NPT / hose 1/2", 1/2" NPT / hose 3/4"; 1/2" NPT, 3/4" hose

WPS 4.0



Diaphragm	Santoprene	Weight	2 kg /4.5 lbs
Valves	EPDM	Length	240 mm/9.46"
Body	PP	Width	214 mm/8.42"
Motor	100W	Height	110 mm/4.33"

Order No.	Description	Capacity	Pressure Cut Off*	Fuse Size	Connection**
10-13406-103	Aqua Jet WPS 4.0, 12V	15L/min / 4.0 GPM	2.8 bar / 41psi	10 A	3/8" NPT / hose 1/2", 1/2" NPT / hose 3/4"; 1/2" NPT, 3/4" hose
10-13406-104	Aqua Jet WPS 4.0, 24V	15L/min / 4.0 GPM	2.8 bar / 41psi	5 A	3/8" NPT / hose 1/2", 1/2" NPT / hose 3/4"; 1/2" NPT, 3/4" hose

WPS 5.2



Diaphragm	Santoprene	Weight	2 kg /4.5 lbs
Valves	EPDM	Length	240 mm/9.46"
Body	PP	Width	214 mm/8.42"
Motor	150W	Height	110 mm/4.33"

Order No.	Description	Capacity	Pressure Cut Off*	Fuse Size	Connection**
10-13406-107	Aqua Jet WPS 5.2, 12V	20L/min/ 5.2 GPM	2.8 bar – 41 psi	15 A	3/8" NPT / hose 1/2", 1/2" NPT / hose 3/4"; 1/2" NPT, 3/4" hose
10-13406-108	Aqua Jet WPS 5.2, 24V	20L/min/ 5.2 GPM	2.8 bar – 41 psi		3/8" NPT / hose 1/2", 1/2" NPT / hose 3/4"; 1/2" NPT, 3/4" hose

*Cut off pressure 2.1 bar/30 psi and 1.4 bar/20 psi available on request

** BSP-connection available on request

AQUA JET UNO WPS 3.5 & 5.2

Medium capacity unit with a single Aqua Jet WPS capacity 13 l/min or 20 l/min fixed on a base with PUMProtector inlet strainer and a 2 litres pre-pressurized accumulator tank.



Order No.	Description	Capacity	Pressure Cut Off*	Fuse Size	Connection**
10-13408-01	WPS Uno 3.5, 12V	13 l/min – 3.5 GPM	2.8 bar – 41 psi	10 A	3/4" hose
10-13408-02	WPS Uno 3.5, 24V	13 l/min – 3.5 GPM	2.8 bar – 41 psi	5 A	3/4" hose
10-13408-03	WPS Uno 5.2, 12V	20 l/min – 5.2 GPM	2.8 bar – 41 psi	15 A	3/4" hose
10-13408-04	WPS Uno 5.2, 24V	20 l/min – 5.2 GPM	2.8 bar – 41 psi	8 A	3/4" hose
10-13281-05	WPS Uno 3.5, 12V	13 l/min – 3.4 GPM	2.8 bar – 41 psi	10 A	1/2" hose
10-13281-06	WPS Uno 3.5, 24V	13 l/min – 3.4 GPM	2.8 bar – 41 psi	5 A	1/2" hose
09-46781-01	Switch, complete, WPS 41 psi		41 psi		

*Cut off pressure 2.1 bar/30 psi and 1.4 bar/20 psi available on request

AQUA JET DUO WPS 10.4

High capacity unit with two parallel-connected Aqua Jet WPS capacity 40 l/min fixed on a base with PUMProtector inlet strainers and a 2 litres pre-pressurized accumulator tank.



Order No.	Description	Capacity	Pressure Cut Off	Fuse Size	Connection
10-13409-01	WPS Duo 10.4, 12V	40 l/min – 10.4 GPM	2.8 bar – 41 psi	25 A	3/4" hose
10-13409-02	WPS Duo 10.4, 24V	40 l/min – 10.4 GPM	2.8 bar – 41 psi	15 A	3/4" hose
09-46781-01	Switch, complete, WPS 41 psi		41 psi		
09-46781-03	Switch, complete, WPS 30 psi		30 psi		

AQUA JET UNO MAX WPS 2.9 & 3.5

Medium capacity unit with a single Aqua Jet WPS with capacity 11 or 13 l/min fixed on a wooden panel for easy and efficient installation. The unit includes a PUMProtector inlet strainer and a 2 litres pre-pressurized accumulator tank.



Order No.	Description	Capacity	Pressure Cut Off	Fuse Size	Connection
10-13410-01	WPS Uno-Max 2.9 12V	11 l/min – 2.9 GPM	2.8 bar – 41 psi	10 A	3/4" hose
10-13410-02	WPS Uno-Max 2.9 24V	11 l/min – 2.9 GPM	2.8 bar – 41 psi	5 A	3/4" hose
10-13411-01	WPS Uno-Max 3.5 12V	13 l/min – 3.5 GPM	2.8 bar – 41 psi	10 A	3/4" hose
10-13411-02	WPS Uno-Max 3.5 24V	13 l/min – 3.5 GPM	2.8 bar – 41 psi	5 A	3/4" hose

AQUA JET FLOW MASTER 5.0 WPS

The ideal choice for pressurizing water in a closed system. The digital controller adjusts water flow as the demand is increased and decreased while maintaining a very smooth flow. The unique variable flow feature of the Flow Master pump allows the pump to be mounted without an accumulator tank and still maintain an even flow regardless if one or multiple taps are being used.



Dimensions	239 mm/9.4" long x 209 mm/8.22" wide x 113 mm/4.49" high	Body	Nylon/Polypropylene
Weight	2 kg/4.5 lbs	Valves	Santoprene/EPDM
Motor	WPS 5.0 – 150 W, 12/24V DC (with built-in thermal protection)	Diaphragm	Santoprene

Order No.	Description	Capacity	Pressure Cut Off	Fuse Size	Connection
10-13329-103	WPS FM 5.0, 12V	19 l/min – 5 GPM	3.5 bar – 50 psi	15 A	3/8" NPT / hose 1/2"; 1/2" NPT / hose 3/4"; 1/2" NPT 3/4" hose 1/2 CTS
10-13329-104	WPS FM 5.0, 24V	19 l/min – 5 GPM	3.5 bar – 50 psi	8 A	3/8" NPT / hose 1/2"; 1/2" NPT / hose 3/4"; 1/2" NPT 3/4" hose 1/2 CTS

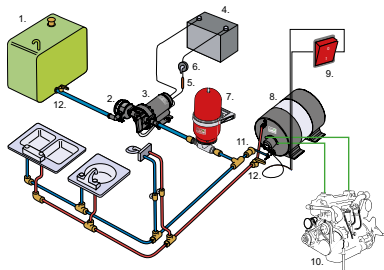

FRESH WATER HANDLING

Components included in a complete Water Pressure Systems

- | | |
|---------------------------------|--------------------------|
| 1. Water tank | 7. Accumulator tank |
| 2. PUMProtector inlet strainer | 8. Water heater |
| 3. Aqua Jet water pressure pump | 9. ON/OFF bipolar switch |
| 4. Battery | 10. Motor |
| 5. Fuse | 11. Check valve |
| 6. Switch | 12. Shut-off valve |

1.1 PUMP/FAUCET COMBINATION

Powerfull 1.1 GPM pump and faucet combination. Self priming diaphragm style demand pump.

Can be mounted above water tank. Easy access, low maintenance. Sleek faucet included.

Available in 12V or 24V models.



Order No.	Description
61123	1.1 GPM Pump & 15" Faucet 12V
61124	1.1 GPM Pump & 15" Faucet 24V
09-CD65582	15" Chrome Plated Faucet
10-22020-101	1.1 GPM WPS Pump FL2202



AQUA JET WASH DOWN PUMP KITS

20 l/min (5.2 GPM) wash down kit conveniently includes a high capacity Aqua Jet WD 5.2, 5 bar (70 psi), PUMProtector inlet strainer, spray nozzle, bulk head fitting with valve, 7.5 meters (25') of coiled wash down hose and an illuminated panel switch – all in one package.



Order No.	Description	Connection	Kit Includes
64535	Aqua Jet 3.5 Wash Down Pump Kit, 12V	3/8" BSP x 1/2" barb	WD Pump, filter, spray pistol, hose and connectors
10-13399-0311	Aqua Jet 3.5 Wash Down Pump Kit, 12V Clamshell	1/2" NPT / hose 3/4", 3/4" GHT, Hose 3/4" GHT	WD Pump, filter, spray pistol, bulkhead fitting, connectors, and panel switch



Order No.	Description	Connection	Kit Includes
64534	Aqua Jet 5.2 Wash Down Pump Kit, 12V	1/2" NPT / hose 3/4", 3/4" GHT, Hose 3/4" GHT Bulkhead fitting – Inlet 3/4" hose, outlet 3/4" GHT	WD pump, filter, hose, spray pistol, bulkhead fitting, hose connectors, and panel switch
64534-24	Aqua Jet 5.2 Wash Down Pump Kit, 24V		
64534CL	Aqua Jet 5.2 Wash Down Pump Kit, 12V Clamshell	1/2" NPT / hose 3/4", 3/4" GHT, Hose 3/4" GHT	WD pump, filter, spray pistol, connectors and hose



ACCESSORIES

Order No.	Description
09-10616	Bulkhead fitting 3/4" hose (pkgd)
61115	Bulkhead fitting 3/4" hose (bulk)
61155	Spray pistol with Hose Connector
69103	Hose connector
10615-00	25 FT Coiled hose
61104-00	US Hose Connector (Orange)

Order No.	Description
09-24653-02-CN	Filter
01-36012 PO2	Strainer cover
09-46780	Rubber feet, qty. 4 pcs.
01-36099-1	Red Slide clip (Bulk)
09-46956	Red Slide Clips (2 pcs)
82024	Wash Down Panel Switch

AQUA JET WASH DOWN PUMPS

As a wash down pump, the Aqua Jet offers much higher pressures than competitive models, making clean-up faster and easier than ever before.

AQUA JET WASH DOWN PUMPS 2.9, 3.5 & 5.2

Complete with trigger nozzle, PUMProtector inlet strainer and hose connections for 1/2" hose. Both BSP and NPT connections included in package

Dimensions	See WPS 2.9, WPS 3.5 and WPS 5.2
Motor	WD 2.9 - 90 W, 12/24V DC WD 3.5 - 120 W, 12/24V DC WD 5.2 - 185 W, 12/24V DC (with built-in thermal protection)

Body	PA/PPA
Valves	Nitrile
Diaphragm	Santoprene

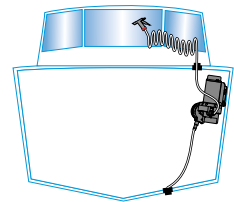

Order No.	Description	Capacity	Pressure Cut Off	Fuse Size	Connection
10-24728-03	WD 2.9, 12V	11 l/min – 2.9 GPM	2.8 bar – 41 psi	10 A	3/8" BSP x 1/2" barb / 1/2" NPT x 3/4" barb
10-24728-04	WD 2.9, 24V	11 l/min – 2.9 GPM	2.8 bar – 41 psi	5 A	3/8" BSP x 1/2" barb / 1/2" NPT x 3/4" barb
10-13399-03	WD 3.5, 12V	13 l/min – 3.5 GPM	5 bar – 70 psi	15 A	1/2" NPT / hose 3/4", GHT 3/4"; 3/8" BSP x 1/2" barb
10-13399-04	WD 3.5, 24V	13 l/min – 3.5 GPM	5 bar – 70 psi	8 A	1/2" NPT / hose 3/4", GHT 3/4"; 3/8" BSP x 1/2" barb
10-13407-07	WD 5.2, 12V	20 l/min – 5.2 GPM	5 bar – 70 psi	20 A	1/2" NPT / hose 3/4", GHT 3/4"; 3/8" BSP x 1/2" barb
10-13407-08	WD 5.2, 24V	20 l/min – 5.2 GPM	5 bar – 70 psi	10 A	1/2" NPT / hose 3/4", GHT 3/4"; 3/8" BSP x 1/2" barb



AQUA JET WASH DOWN PUMP KITS

Kit Includes everything you need to washdown your boat, RV, water craft and more. Use any water available fresh or salt water. Complete with collapsing hose, spray nozzle, input hose with filter, 3.5 wash down pump, dual power option 12V cigarette lighter power cord, and battery clips to power from battery terminals. 70 PSI pressure. Fully ingestion protected and CE approved washdown pump.

Order No.	Description
64736-00	3.5 Portable Wash Down Pump Kit, 12V
09-60616	Portable WD flexible hose





UNIVERSAL STRAINER

Materials	Strainer – Polyamide 66, black	Diameter	80 mm / 3.15"
	Cover – Acrylic, clear, 01-36012 P02	Height	60 mm / 2.35"
	Screen – Stainless steel, 20 and 40 mesh	Weight	0.15 kg / 0.33 lbs
	O-rings – Silicone and EPDM	Mesh size	20 or 40

Order No.	Description	Mesh	Max Liquid Temp.	Max Temp. for Drinking Water	KlickTite™ Connector
09-24652-02-CN	Universal Strainer	40	+50°C – +120°F	+30°C – +85°F	2 x 1/2" hose / 3/8" NPT, 2 x 3/4" hose / 1/2" NPT
09-24652-04-CN	Universal Strainer	20	+50°C – +120°F	+30°C – +85°F	2 x 1/2" hose / 3/8" NPT, 2 x 3/4" hose / 1/2" NPT

*Strainer cover P/N, 01-36012 P02, O-Ring not included

INLET STRAINER

Materials	Strainer – Polyamide 66, black	Diameter	80 mm / 3.15"
	Cover – Acrylic, clear, 01-36012 P02	Height	60 mm / 2.35"
	Screen – Stainless steel, 20 and 40 mesh	Weight	0.15 kg / 0.33 lbs
	O-rings – Silicone and EPDM	Mesh size	20 or 40

Order No.	Description	Mesh	Max Liquid Temp.	Max Temp. for Drinking Water	KlickTite™ Connector
09-24653-02-CN	Inlet Strainer	40	+50°C – +120°F	+30°C – +85°F	Built-in KlickTite™ 1 x 1/2" hose / 3/8" NPT, 1 x 3/4" hose / 1/2" NPT
09-24653-03-CN	Inlet Strainer	40	+50°C – +120°F	+30°C – +85°F	Built-in KlickTite™, Bulk pack w/o connectors

*Strainer cover P/N, 01-36012 P02, O-Ring not included



KLICKTITE™ PORT CONNECTORS

KlickTite™ port connectors are available for virtually any hose diameter and make it possible to remove the entire unit for thorough cleaning wherever it's most convenient. They also make it possible to drain the system quickly for effortless winterizing without the use of any tools.

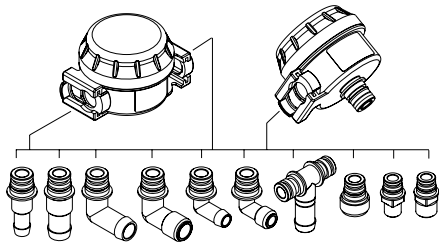

Order No.	pcs/package	KlickTite™ Connector
09-46957	2	2 x 1/2" hose and 3/8" NPT
09-46958	2	2 x 3/4" hose and 1/2" NPT
09-46939	2	2 x 90°, 3/4" hose
09-47088	2	2 x 90°, 1/2" NPT
09-46938	2	2 x 90°, 1/2" hose
09-47089	2	2 x 90°, 3/8" NPT
09-47092	1	1 x T-connection, 3/4" barb
09-47094	2	2 x Garden hose adapter
09-47087	2	2 x 90° 1/2" BSP / 3/4" hose
09-47098	2	2 x 1/2" BSP / 1/2"-14 NPSM

ACCUMULATOR TANK

The use of an accumulator tank is recommended to ensure effective and reliable system function. With an accumulator tank incorporated in the system, the intervals between cut-in and cut-out will be longer when only small amounts of water are drawn off. Less wear and tear on the pump with fewer starts and stops. Pre-pressurized at 0.8 bar / 12 psi.



Volume	2 l / 0.5 gal.
Port connections	1/2" or 3/4" hose
Height	315 mm / 12.4"
Diameter	160 mm / 6.3"
Weight	1,2 kg / 2.7 lbs

Order No.	Connection
09-46839-01	1/2" hose connection
09-46839-02	3/4" hose connection

ACCESSORIES

DECK WASH 316 STAINLESS FLUSH MOUNT

- Flush mount
- Connects and disconnects under full pressure.
- Positive lock bayonet connector.
- Double viton o-ring seals.
- Large flow capacity.
- 316 stainless steel.
- Connections made of Nylon 66.
- Two connector versions: American standard garden hose (blue)



61121



61122

DECK WASH HARDWARE

Order No.	Connection
40057	Water pressure regulator
61121	Single outlet, single flush
61122	Double outlet, 2 way flush
61127A	90 deg. WD bulkhead fitting



61127A



40057

TANK MONITORING

Monitors 3 holding tanks with digital accuracy. "Field Effect" sensors mount on the outside of any polyethylene or polypropylene tank up to 10 mm thick. Great for fresh, gray or black water tanks. Monitor panel reads level for each tank.

Order No.	Description
200600032	Sensa Tank Marine 100



BIO REMEDIATION PRODUCTS

Environmentally remediates hydrocarbon spills naturally.

Order No.	Connection
58001-00	Biosok, 1 foot
58005-00	Fuel sorber - Fuel collar
58008	Oil sorb powder
58003	10 ft Bio boom
58004-00	4 ft Bio boom

- Used for oil/gas/diesel redmediation
- Environmentally friendly



Heavy Duty Submersible Bilge Pumps

Photo: Munson



The SPX Johnson Pump Marine submersible pumps can handle most bilge pump applications. Heavy duty motors with stainless steel (SS2343) shaft and tough thermoplastic bodies provide for a long pump life. With an automatic switch installed, the pump automatically starts on when there is water in the bilge and shuts off when it is dry. Salt water tested - salt water tough.



CE marked according to following standards:

- EN55014: 1993/Radio disturbance
- ISO8846: Small Craft – Electrical devices
 - Protection against ignition of surrounding flammable gases
- ISO8849: Small craft – Electrically operated bilge pumps
- ISO10133: Small Craft – Electrical systems
 - Extra-low voltage DC installations

HEAVY DUTY BILGE PUMP – 1600-4000 SERIES

Designed to meet and exceed the tough demands of commercial and recreational duty. This pump has a liquid cooled, 12-pole motor with double ball bearings for extended service life. The 2200 motor is sealed off by a mechanical seal design, while the 1600 model has lipseal. The impeller is carefully designed and tested to maximize head and flow. The 4000 features a robust motor design, mechanical shaft seal, high impact ABS plastic and unique threaded port design. Universal base plate and a choice of 1½" or 2" ports makes for a simple installation. Removable check valve included.

1600		2200		4000	
Shaft	SS2343	Shaft	SS2343	Shaft	SS2343
Wire size	1.3 mm ² – 16 GA	Wire size	1.3 mm ² – 16 GA	Wire size	2 mm ² – 14 GA
Wire length	1.8 m – 6 ft	Wire length	1.8 m – 6 ft	Wire length	1.8 m – 6 ft
Max Ø	108 mm – 4.25"	Max Ø	108 mm – 4.25"	Max Ø	121 mm – 4.8"
Max height	149 mm – 5.86"	Max height	177 mm – 7"	Max height	216 mm – 8.5"
Weight	1.3 kg – 2.75 lbs	Weight	2.7 kg – 6 lbs	Weight	2.45 kg – 5.4 lbs

Order No.	Description	Capacity 1.0 m head (13.6 V/27 V)	Capacity straight (13.6 V/27 V)	Amperage	Fuse Size	Connection
16004-00	1600 12 V	98 l/min – 1550 GPH	100 l/min – 1600 GPH	7 A	10 A	1½" and 1¼"
16084-00	1600 24 V	98 l/min – 1550 GPH	100 l/min – 1600 GPH	3.5 A	6 A	1½" and 1¼"
22004	2200 12 V	120 l/min – 1900 GPH	130 l/min – 2060 GPH	7.5 A	12 A	1½" and 1¼"
22084	2200 24 V	120 l/min – 1900 GPH	130 l/min – 2060 GPH	4.5 A	6 A	1½" and 1¼"
40004	4000 12 V	164 l/min – 2600 GPH	252 l/min – 4000 GPH	15 A	25 A	1½" and 2"
40084	4000 24 V	164 l/min – 2600 GPH	252 l/min – 4000 GPH	7.5 A	15 A	1½" and 2"

For automatic operation use Ultima switch for 40004/40084 models



HEAVY DUTY BILGE PUMP AUTOMATIC – 1600-2200 SERIES

Order No.	Description	Capacity 1.0 m head (13.6 V/27 V)	Capacity straight (13.6 V/27 V)	Amperage	Fuse Size	Connection
01604-00*	1600 12 V	98 l/min – 1550 GPH	100 l/min – 1600 GPH	7 A	10 A	1½" and 1¼"
01604-002*	1600 24 V	98 l/min – 1550 GPH	100 l/min – 1600 GPH	3.5 A	6 A	1½" and 1¼"
01674-001**	1600 12 V	98 l/min – 1550 GPH	100 l/min – 1600 GPH	7 A	10 A	1½" and 1¼"
01674-002**	1600 24 V	98 l/min – 1550 GPH	100 l/min – 1600 GPH	3.5 A	6 A	1½" and 1¼"
02204-00*	2200 12 V	120 l/min – 1900 GPH	130 l/min – 2060 GPH	7.5 A	12 A	1½" and 1¼"
02204-002*	2200 24 V	120 l/min – 1900 GPH	130 l/min – 2060 GPH	4.5 A	6 A	1½" and 1¼"
02274-00**	2200 12 V	120 l/min – 1900 GPH	130 l/min – 2060 GPH	7.5 A	12 A	1½" and 1¼"
022741-002**	2200 24 V	120 l/min – 1900 GPH	130 l/min – 2060 GPH	4.5 A	6 A	1½" and 1¼"

* Electro-magnetic included.

** Ultima Switch included.

ACCESSORIES

Order No.	Description	Order No.	Description
50102	L1600/2200 check valve washer	54061-22	1½" port, fits 1600/2200 models
50511	L1600/2200 check valve flapper	54061-23	1¼" port, fits 1600/2200 models
50581	L4000 check valve flapper	54061-24	1" port, fits 1600/2200 models
51122	L4000 check valve washer	54264	Base 1600/2200
		54274	Base 4000



01604-00 (12V),
01604-002 (24V)



01674-001(12V),
01674-002 (24V)



02204-00 (12V),
02204-002 (24V)



02274-001(12V),
02274-002 (24V)



CARTRIDGE BILGE PUMPS 500-1250 SERIES

1000 GPH and 1250 GPH incorporate some of the most advanced features in the industry, features developed from service in a wide variety of uses including racing, cruising, sport fishing, and demanding commercial duties. For 500 GPH, 750 GPH, and 1000 GPH, we have improved the design with easy-to-install Dura-Port discharge ports to eliminate stress cracking caused by over-tightened hose clamps. The pumps are delivered including both a straight and a 90° smooth elbow Dura-Port as well as a removable check valve.

500 GPH – 1000 GPH

Max Ø 70 mm – 2.75"
 Max height 112 mm – 4.4"
 Weight 0.27 kg – 9.6 oz.

1250 GPH

Max Ø 70 mm – 2.75"
 Max height 112 mm – 4.4"
 Weight 0.32 kg – 10.4 oz.

Order No.	Description	Voltage	Capacity 3 ft (0.9 m) head (13.6 V)	Capacity straight (13.6 V)	Amperage	Fuse Size	Connection
32503	500 GPH	12V	33 l/min - 525 GPH	40 l/min - 630 GPH	2.5 A	5 A	3/4"
32703	750 GPH	12V	44 l/min - 700 GPH	50 l/min - 800 GPH	3 A	5 A	3/4"
32903	1000 GPH	12V	50 l/min - 800 GPH	63 l/min - 1000 GPH	3.2 A	5 A	3/4"
32903-24 V	1000 GPH	24V	50 l/min - 800 GPH	63 l/min - 1000 GPH	2 A	3 A	3/4"
42123*	1250 GPH	12V	60 l/min - 952 GPH	73 l/min - 1150 GPH	3 A	5 A	1 1/8"
42123-24*	1250 GPH	24V	60 l/min - 952 GPH	73 l/min - 1150 GPH	2 A	3 A	1 1/8"

*) Do not include Dura-Port connection

*) Dura-Port not included

ACCESSORIES, 500-1000 GPH ONLY

Order No.	Description
50533	Check valves, 500-1000 GPH
92105	DuraPort, straight
92205	DuraPort, 90°

See page 19 for replaceable motor cartridges

OPTIONS, 500-1000 GPH ONLY

Order No.	Description
51123	Threaded on Flow Rite, straight, male
51124	Threaded on Flow Rite, 90°, male

LOW BOY BILGE PUMP

Low Profile pump design for ease of mounting and removal in tight bilge areas. Perfect for vessels with bilge pumps mounted beneath inboard or I/O engines. Removable cartridge style. For 750 GPH Low Boy Bilge pumps we have easy-to-install Dura-Port discharge ports to eliminate stress cracking caused by over-tightened hose clamps. The pumps will be delivered including both a straight and a 90° smooth elbow. Use 36152 magnetic switch only.



Max length 146 mm – 5.75"
 Width 81 mm – 3.2"
 Height 72 mm – 2.82"
 Wire size 1.3 mm² – 16 GA

Order No.	Description	Capacity 3 ft (0.9 m) head (13.6 V)	Capacity straight (13.6 V)	Amperage	Fuse Size	Connection
33703	750 GPH Low Boy Bilge Pump, 12V	44 l/min - 700 GPH	50 l/min - 800 GPH	3 A	5 A	3/4"
33103*	1250 GPH Low Boy Bilge Pump, 12V	60 l/min - 952 GPH	73 l/min - 1150 GPH	3 A	5 A	1 1/8"

*) Do not include Dura-Port connection

ULTIMA COMBO

Pump with automatic operation equipped with the Ultima switch. Voltage 12 V DC as well as 24 V DC for 1000 GPH UC and 1250 GPH UC. For 500 GPH UC - 1000 GPH UC, we have easy-to-install Dura-Port discharge ports to eliminate stress cracking caused by over-tightened hose clamps. The pumps will be delivered including both a straight and a 90° smooth elbow Dura-Port as well as a removable check valve.

500 UC – 1000 UC

Max Ø 100 mm – 3x4"
Max height 112 mm – 4.4"
Weight 0.4 kg – 14.4 oz.

1250 UC

Max Ø 70 mm – 2.75"
Max height 112 mm – 4.4"
Weight 0.45 kg – 16 oz.



Order No.	Description	Capacity 3 ft (0.9 m) head (13.6 V)	Capacity straight (13.6 V)	Amperage	Fuse Size	Connection
07503-00	500 GPH Ultima Combo, 12V	33 l/min - 525 GPH	40 l/min - 630 GPH	2.5 A	5 A	3/4"
07703-00	750 GPH Ultima Combo, 12V	44 l/min - 700 GPH	50 l/min - 800 GPH	3 A	5 A	3/4"
07903-00	1000 GPH Ultima Combo, 12V	50 l/min - 800 GPH	63 l/min - 1000 GPH	3.2 A	5 A	3/4"
07903-24	1000 GPH Ultima Combo, 24V	50 l/min - 800 GPH	63 l/min - 1000 GPH	2 A	3 A	3/4"
08203-00*	1250 GPH Ultima Combo, 12V	60 l/min - 952 GPH	73 l/min - 1150 GPH	3 A	5 A	1 1/8"
08203-24*	1250 GPH Ultima Combo, 24V	60 l/min - 952 GPH	73 l/min - 1150 GPH	2 A	3 A	1 1/8"

*) Do not include Dura-Port connection

CARTRIDGE COMBO SERIES

Combines the line of cartridge bilge pumps with automatic operation. Equipped with a non-clogging electronic float switch. (Electromagnetic switch)

Order No.	Description	Capacity 3 ft (0.9 m) head (13.6 V)	Capacity straight (13.6 V)	Amperage	Fuse Size	Connection
05503-00	500 GPH Cartridge Combo, 12V	33 l/min - 525 GPH	40 l/min - 630 GPH	2.5 A	5 A	3/4"
05703-00	750 GPH Cartridge Combo, 12V	44 l/min - 700 GPH	50 l/min - 800 GPH	3 A	5 A	3/4"
05903-00	1000 GPH Cartridge Combo, 12V	50 l/min - 800 GPH	63 l/min - 1000 GPH	3.2 A	5 A	3/4"
06203-00*	1250 GPH Cartridge Combo, 12V	60 l/min - 952 GPH	73 l/min - 1150 GPH	3 A	5 A	1 1/8"

*) Do not include Dura-Port connection



PROLINE BILGE

Order No.	Description	Capacity 3 ft (0.9 m) head (13.6 V)	Capacity straight (13.6 V)	Amperage	Fuse Size	Connection
22502	500 GPH Proline Bilge, DuraPorts	33 l/min - 525 GPH	40 l/min - 630 GPH	2.5 A	5 A	3/4"
22702	750 GPH Proline Bilge, DuraPorts	44 l/min - 700 GPH	50 l/min - 800 GPH	3 A	5 A	3/4"
22102	1000 GPH Proline Bilge, DuraPorts	60 l/min - 952 GPH	73 l/min - 1150 GPH	3 A	5 A	3/4"



ULTIMA BILGE PUMP

Sleek, reliable and compact unit with integrated switch ready to install and run for years and years of unerring service. Available in 600-800-1000-1250 GPH versions. Voltage 12 V DC. For UltimaBilge™ 600 GPH-1000 GPH, we have easy-to-install Dura-Port discharge ports to eliminate stress cracking caused by over-tightened hose clamps. The pumps are delivered including both a straight and a 90° smooth elbow Dura-Port and a removable check valve.

600, 800 & 1000 GPH

Length 142 mm – 6"
Width 82 mm – 3.2"
Height 105 mm – 4.1"
Weight 0.66 kg – 23.3 oz.

1250 GPH

Length 142 mm – 6"
Width 82 mm – 3.2"
Height 117 mm – 4.6"
Weight 0.66 kg – 23.3 oz.

Order No.	Description	Capacity 3 ft (0.9 m) head (13.6 V)	Capacity straight (13.6 V)	Amperage	Fuse Size	Connection
32-47258-003	600 GPH, 12 V	32 l/min - 500 GPH	38 l/min - 600 GPH	2.5 A	5 A	3/4"
32-47259-003	800 GPH, 12 V	38 l/min - 600 GPH	51 l/min - 800 GPH	3 A	5 A	3/4"
32-47260-003	1000 GPH, 12 V	44 l/min - 700 GPH	64 l/min - 1000 GPH	3.2 A	5 A	3/4"
32-47261-002*	1250 GPH, 12 V	51 l/min - 800 GPH	79 l/min - 1250 GPH	3 A	5 A	1 1/8" and 1 1/4"

*) Not included with 1250 GPH Dura-Port connection



54315 Low Basket

SPARE PARTS, 600, 800, SPARE PARTS, 1250 GPH ONLY

1000 GPH

Order No.	Description
92105	Straight duraport
92205	90° duraport
50533	Check valve, nitrile, for all cartridge pumps

Order No.	Description
54061-22	1 1/8" thread discharge port
54061-23	1 1/4" thread discharge port
50102	Washer
50511	Flapper, nitrile, 2200

Order No.	Description
50533	3/4" Check valve for 600, 800, 1000
50102	1 1/8" Check valve washer for 1250
50511	1 1/8" Check valve flapper for 1250

HIGH PERFORMANCE FIRST MATE

Designed specifically for Pontoon livewell and PWC Bilge applications. Where space is at a premium and ease of maintenance is desired. Easy to plumb 90 degree Dura port makes short work of challenging hose routing.



Order No.	Description	Capacity straight (13.6 V/27 V)	Amperage	Fuse Size	Connection
21405HP	High Performance First Mate, 12V	30 l/min - 400 GPH	2.5 A	5 A	3/4"

FIRST MATE

A low budget alternative designed for long life and high performance capacity. The low cost choice for boat owners who still look for quality.



Max Ø	115 mm – 4.5"
Max height	100 mm – 4"
Weight	0.35 kg – 12 oz.

Order No.	Description	Capacity straight (13.6 V/27 V)	Amperage	Fuse Size	Connection
21405	First Mate, 12V	30 l/min - 400 GPH	2.5 A	5 A	3/4"

MULTIPLE PORT SHOWER SUMP

This compact shower sump system is designed to meet the higher demands from today's boating industry where more equipment is used. This also includes the fresh water system onboard and involves showers, dish-washing machines, galley sinks, etc. The shower sump turns on/off automatically using our Ultima switch technology and has multiple inlet ports for handling waste water from more than one tapping point. The check valve on the outlet stops water from flowing back into the tank. The tank has a tight-fitting lid to minimize splashing and odors. To further aid in cleaning, the system includes an easily removable mesh filter.



LxW	290x210 mm – 11.42x8.26"
Max height	145 mm – 5.7"
Weight	0.9 kg – 2 lbs

Order No.	Description	Capacity 1.0 m head (13.6 V/27 V)	Capacity straight (13.6 V/27 V)	Amperage	Fuse Size	Intake connection	Discharge connection
57151	Multiple Port Shower Sump, 12V	53 l/min - 844 GPH	61 l/min - 972 GPH	3.4 A	5 A	1x 3/4", 1x 3/4" or 1x 1"	3/4"
57151-24	Multiple Port Shower Sump, 24V	53 l/min - 844 GPH	61 l/min - 972 GPH	2 A	3 A	1x 1 1/8" or 1x 1 1/2"	3/4"
54304	Clear Sump Cover						
28512	Motor 1000 GPH repl., 12V						
28512-24V	Motor 1000 GPH repl., 24V						
36303	Ultima Switch 12/24V						

BILGE PUMP SYSTEM

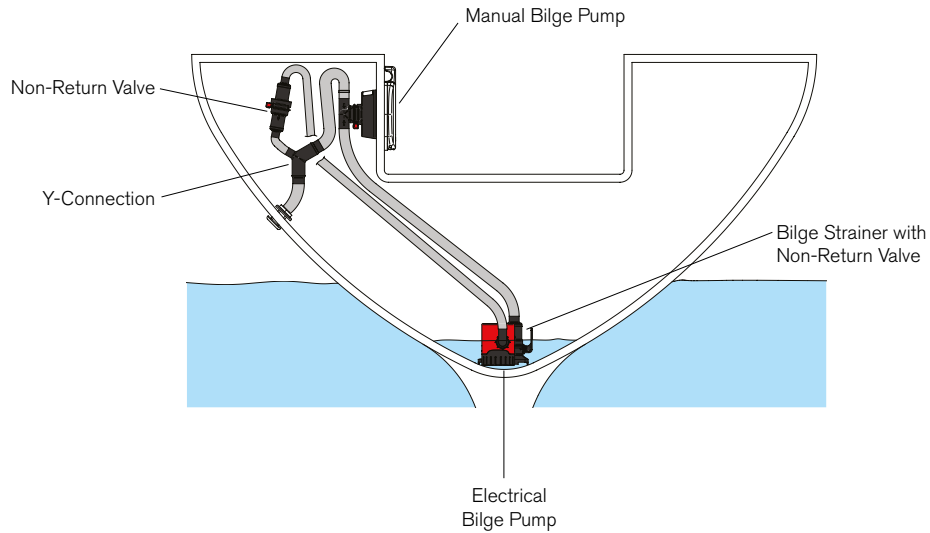

VIKING COMPACT, MANUAL AND ELECTRICAL IN COMBINATION

Full-capacity, hand-powered bilge pump perfect for installation in tight spaces.

This rugged, yet sleekly designed, single-chamber diaphragm pump provides first-rate performance and is a snap to install. It can be fitted in minutes from one side of the bulkhead with just four screws, self-sealing against the surface with a durable, watertight gasket. With the pump house recessed behind the bulkhead, only the handle is visible from the cabin or cockpit.

The Viking Compact's inlet and outlet ports can be swiveled 360° and are delivered in two sizes with every pump, Ø25mm (1") and Ø38mm (1 1/2"). Naturally, the Viking Compact has KlickTite™ connectors fitted as standard, literally making hose connections a snap!



Dependability in the grasp of your hand!

Flow at 10 kPa head and 45 strokes/min

Ø25mm connections 34,5 liters/minute (9.1 US gallons/minute)
 Ø38mm connections 45 liters/minute (11.9 US gallons/minute)

Body	Polypropylene	Maximum lift	2.1 meters (7 feet)
Cover	ABS	Maximum head	1.2 meters (4 feet)
Diaphragm	Nitrile rubber	Combined head/lift	3.3 meters (10.8 feet)
Valves	Nitrile rubber (1 leaf and 1 tricuspid valve)	Connection	KlickTite™ connectors for 1" (25 mm) or 1 1/2" (38 mm) hose. Both options included
Wetted parts	Polypropylene, PA66GF30 plastics and nitrile rubber	Max. liquid temp	+60°C (140°F)
		Weight	0.675 kg (1.5 pounds)

Order No.	Description
10-24800-01	Viking Compact w. dia. 25 mm (1") and dia. 38 mm (1 1/2") ports.
10-24800-10	Viking Compact w. dia. 38 mm (1 1/2") ports Bulk pack.
10-24800-11	Viking Compact w. dia. 25 mm (1") ports Bulk pack.
10-24800-12	Viking Compact w. dia. 38 mm (1 1/2") ports and 25 mm (1") ports. Bulk pack



VIKING UNIVERSAL

Heavy duty, self-priming, hand-powered bilge pump for nearly any type of installation.

Viking Universal's mounting bracket allows for vertical or horizontal surface mounting. With the optional Through Deck kit the pump can be installed behind bulkheads or below the deck. To minimize required space the Viking Universal excels at adaption. The simple switching of the valves together with the connections allows you to choose flow direction. The included KlickTite™ straight and 90° hose connections can be used in combination. The hose connections and even the pump housing can easily be rotated for optimal positioning. While designed as a powerful bilge pump, the Viking Universal's large Ø38 mm (1½") valves enable the pump to also be used for pumping toilet waste.

Fasteners are included for stowing the handle and the safety clasp ensures that the handle cannot be lost while not in use or during an emergency situation. Viking Universal meets ISO 15083, "Bilge pumping systems". At 45 strokes/min and a 1 m (3.28') head (10 kPa (1.45 psi) pressure) the Viking Universal has a flow of 60 l/min - 16 GPM.

Body and cover	Polypropylene plastic reinforced with 30% fiberglass
Diaphragm and valves	Nitrile rubber
Wetted parts	PP30GF, PA66 GF30, POM, stainless steel, nitrile rubber
Maximum suction	3 meters (10')
Maximum head	4 meters (13')
Combined suction/head	7 meters (23')
Connection	KlickTite™ connectors 38 mm (1½") hose. Both straight and 90° bends are included
Max. liquid temp	+60°C (140°F)
Weight	1.5 kg (3.3 lbs)

Order No.	Description
10-13530-01	Viking Universal with connection diameter 38 mm (1½')
09-36250	Viking Universal Through Deck Kit

VIKING THRUDECK AND BULKHEAD

When the power is out you can always depend on the hand operated diaphragm bilge pump. The Viking pump can also be used for pumping toilet waste due to the large valve openings. The pump is available in two models for various installation alternatives. It can be mounted behind walls, through deck and under bulkheads.

Viking ThruDeck for installation behind vertical wall or under deck with sealing boot, complete with a cover plate. Viking Bulkhead for surface installation with horizontal lever.



Capacity data (At 1 m/3.28" suction height: 0.9 l/stroke)	Diameter	164 mm – 6.45"
60 strokes/min 54 l/min – 14.5 GPM	Handle length	285 mm – 11.22"
80 strokes/min 72 l/min – 19 GPM	Width	253 mm – 9.96"
100 strokes/min 90 l/min – 24 GPM	Height	133 mm – 5.23"
	Weight	2 kg – 4.5 lbs
Max suction height 4 m – 13 ft		

Order No.	Description
70-50005	ThruDeck 1½"
70-50025	ThruDeck 1"
70-50007	Bulkhead 1½"
70-50027	Bulkhead 1"

MANUAL & ELECTRIC BILGE PUMP ACCESSORIES

- Designed to install in-line
- Maintains prime in a suction or discharge line
- Easy to maintain and clean without any tools
- Designed to prevent bilge debris blocking the inlet suction line
- Reduce the risk of debrisenetering and blocking the pump
- Maintain prime in the suction line
- Easy to maintain and clean without any tools

Y-connections enable two pumps to discharge through a single line. Diverter valve is not required.

In-Line Non-Return Valve

Order No.	Description	Connection
09-24792	In-Line Non-Return Valve	25/38 mm (1" / 1½")
09-24818	In-Line Non-Return Valve	19/32 mm (¾" / 1¼")

Bilge Strainer With Non-Return Valve

Order No.	Description	Connection
09-24794	Strainer	19/32 mm (¾" / 1¼"), 25/38 mm (1" / 1½")

Y-connections

Order No.	Description
01-24814	Y-connection 38X38X25
01-24815	Y-connection 29/32X29/32X19



HAND PUMPS

Light tough durable easy handling, extra fast pumping hand pumps are ideal stow aboards. Comfortable handle grip and extra large capacity makes manual pumping somewhat less of a chore. Ideal for emergency pumping and where electrical current is not available.

Order No.	Description
20195	18", 8 strokes per gallon
20255	25", 6 strokes per gallon
20375	36", 4 strokes per gallon



SPARE MOTOR FOR CARTRIDGE

Upgrade the output of your bilge pump in a matter of a few minutes by replacing the cartridge. Cleaning debris from the impeller has never been simpler or easier.

Order No.	Description
28552	Motor for 500 GPH pumps
28572	Motor for 750 GPH pumps, 12V
28512/42522	Motor for 1000 GPH and 1250 GPH pumps, 12V



BILGE PUMP CONTROL

Switch panel that gives full control of your equipment. Just push the button for manual or automatic bilge pumping. The automatic feature operates in combination with the automatic bilge switches or the electronic float switch. The three-position switch panel in matt black finish has an integrated fuse holder and operating light. Fuses included.

Size: 73 mm/2.99" x60 mm/2.17", 40 mm/ 1.57" depth.

Order No.	Description
82044	3 Way Bilge Pump Control, 12V
82044-24 V	3 Way Bilge Pump Control, 24V
82004	2 Way Bilge Pump Control, 12V
82004-24 V	2 Way Bilge Pump Control, 24V



3 Way Bilge Pump Control

BILGE PUMP COUNTER

Easy to read and resettable bilge pump counter. Check frequency of bilge pump operation to head off potential issues down the road.

Order No.	Description
83000	Bilge pump counter





ULTIMA SWITCH™

Uses the patented Mirus field effect detector cells producing micro-electrical fields that detect disruptions caused by water and fluids. Detector cells are totally sealed and are never in contact with the water, will not corrode and are not affected by oil or foreign debris. No moving parts, totally sealed solid state electronics and field detectors, no mercury and no exposed sensors eliminate corrosion possibilities and makes the Ultima switch environmentally sensitive. Ultima activates at a 50 mm (2") fluid level and deactivates at a 20 mm (¾") fluid level. A 3 second delay prevents false starts. Ultima switch is rated to handle pumps up to 20 amps at 12 or 24 volts.

Order No.	Description	Max Amp.
36303	Ultima Switch, 12/24V	20 A
54239	Base	



AUTOMATIC SWITCH AS888/26014

For full automatic bilge pumping operation, connect the automatic switch to your bilge pump. The AS888 automatic switch has a time-proven micro switch without mercury. When water exceeds the acceptable level, the pump is turned on by a rolling steel ball, which changes the pressure on the micro switch. The AS888 attaches to any SPX Johnson Pump Marine bilge pump through the clip on "T-slot" and can be used with 6, 12, 24 or 32 V systems. Use AS888 for a better and safer life afloat!

Order No.	Description	Max Amp.
26014	Automatic Switch AS888	15 A



ELECTRONIC FLOAT SWITCH

Compact mechanical switch offers a combination of reliable solid state electronics and a sealed float switch. False start prevention, no mercury, high impact plastic and encapsulated electronics adds up to dependability. Activates pump at 2" water level, deactivates pump at ¾" water level. 12V. Handles up to 15 amps.

Order No.	Description	Max Amp.
36152	Electronic Float Switch, 12V	15 A
36252	Electronic Float Switch, 24V	8 A
54239	Base, Electronic Switch	

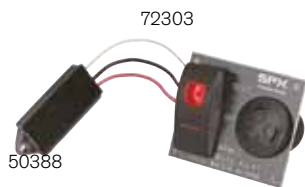

72303

50388

Bilge Alert w/ sensor

(72303-001/-002)



Bilge Alert w/ Ultima

36303



BILGE ALERT™

High water alarm featuring digital technology using the patented Mirus field effect. Totally sealed fluid detector are never in contact with water, will not corrode and are not affected by oil or debris. Bilge Alert detects water and sends a signal (3 seconds delay) to the alarm and switch conveniently mounted on a panel. Three way rocker switch allows alarm to be tested, turned off and armed.

Order No.	Description
72303-001	Bilge Alert, High Water Alarm, w/ Ultima, 12V
72303-002	Bilge Alert, High Water Alarm, w/ Ultima, 24V
72303	Bilge Alert, High Water Alarm, w/ sensor, 12V

Order No.	Description
10605-00	90° Side Mount Bracket



Fishing Livewell Pumps and Accessories



Leading the way, SPX Johnson Pump has a full assortment of Livewell and Aerator pumps to meet the demanding needs of recreational and professional fisherman worldwide. Easy to clean and maintain replaceable motor cartridges. Pump styles in straight, 90 degree and sea cock installations available in flow rates from 500 GPH to 1600 GPH. A variety of accessories to complete that livewell installation including wash down kits, ice chest aerators, spary bars, and thru hull fittings. When you think livewell pumps think SPX Johnson Pump.



CE marked according to following standards:

- EN55014: 1993/Radio disturbance
- ISO8846: Small Craft – Electrical devices
 - Protection against ignition of surrounding flammable gases
- ISO8849: Small craft – Electrically operated bilge pumps
- ISO10133: Small Craft – Electrical systems
 - Extra-low voltage DC installations

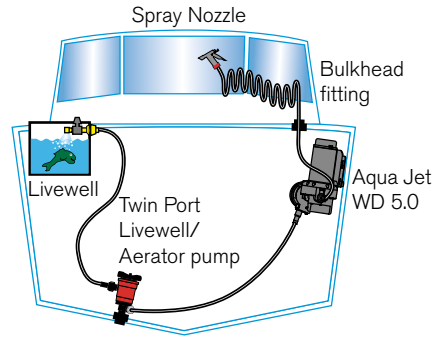

TWIN PORT PUMPS

Offer the convenience of using only one intake for both the livewell and raw water wash down pump. The 3/4" tapered inlet connects directly to the sea cock and the upper outlet port provides a continuous flow of water through the 3/4" discharge to the livewell while the lower outlet port connects to the wash down pump through either a 1/2" or 3/4" ports. New high pressure inlet seal easily handles the higher pressures created by high speed pickups commonly used.

Order No.	Description
48503	500 GPH 12V
48703	750 GPH, 12V
48903	1000 GPH, 12V
48103	1250 GPH, 12V*

*1 1/8" discharge to livewell. Does not include Dura-Port.



CARTRIDGE AERATOR PUMP

Livewell pumps in 500 GPH and 750 GPH capacities with two different intake configurations of straight and 90°. Smaller profiles to fit in more confined spaces. Easy to change motor cartridge.

Order No.	Description
28503	500 GPH straight
38503	500 GPH 90°
28703	750 GPH straight
38703	750 GPH 90°
28103-00	1000 GPH straight, 12V
38103	1000 GPH 90°, 12V
28123	1250 GPH straight 1 1/8" outlet
38123	1250 GPH 90° inlet, 1 1/8" outlet no Dura-Ports

Order No.	Description
61125	Aerator Timer
82054	Aerator panel switch

Will turn on or cycle your aerator



Nut for thruhull 54033

AQUA JET WD /LIVEWELL PUMP KIT 5.2

A wash down kit including a high capacity Aqua Jet WD 5.2, 5 bar (70 psi) pump, a 500 GPH Twin Port livewell pump, PUMProtector inlet strainer, spray nozzle, bulk head fitting with valve, 7.5 meters (25') of coiled wash down hose and two illuminated panel switches all in one package. Aqua Jet wash down/livewell pump kit makes it easy to add a wash down and livewell pump to any boat.



Order No.	Description
64634	Aqua Jet 5.2 WD/ 500 Livewell Pump Kit, 12V

PRO SERIES 1600 GPH LIVEWELL/BAITWELL

Features heavy duty bronze bottom inlet, 1600 GPH of pumping power, dual port capability, mega torque motor, double ball bearings, quiet running design, 1" NPT female intake. Built for the serious fisherman.



Order No.	Description	Capacity straight (13.6 V)	Capacity 3 ft (0.9 m) head (13.6 V)	Amperage	Fuse Size	Connection
16004B	1600 GPH, 12 V	1600 GPH	1550 GPH	7 A	10 A	1 1/8" and 1 1/4"
16004B-24	1600 GPH, 24 V	1600 GPH	1550 GPH	3.5 A	6 A	1 1/8" and 1 1/4"

* Replacement for Pro Series (not including bronze base)

16004-00 12V Bilge

16084-00 24V Bilge

Spare Parts

Order No.	Description
54061-22	1 1/8" Discharge Port
54061-23	1 1/4" Discharge Port

ICE CHEST AERATOR KIT

Converts any good sized ice chest (Eskey) into your own portable live bait tank. The Ice Chest Aerator will keep your live bait alive, or catch fresh, even during the heat of the day. Includes a sturdy First Mate pump, hose, spray bar, press on clamp, battery clamps and clear-cut instructions. Since there are no holes to drill the chest can always be returned to its original purpose.

Order No.	Description
24052	Ice Chest Aerator kit
60000	Cartridge style Aerator kit, complete with Batt. clips, Head, Mounting Feet



IN-WELL AERATOR KIT

The easiest way to add oxygen to your live bait well. Use it as your primary aerator, or to recirculate while you are making a long run across the bay, or if you are trailing the boat, you can stop for fuel and be aerating your catch while the boat is on the trailer. A dependable 500 GPH pump forces water through the aerating head to provide vital oxygen for respiration ensuring your bait stays fresh longer. To empty the well at the end of the day, merely open the valve, activate the pump and water passes through a discharge fitting.



Order No.	Description
34024	In-well Aerator kit

BAITWELL PUMPS

Designed for self priming water transfer to keep bait alive and active. Quiet five chamber design.

Order No.	Description	Capacity	Pressure Cut Off*	Fuse Size	Connection**
10-24677-03	2.4 GPM Baitwell, 12V	9 l/min – 2.4 GPM	N/A	10 A	3/8" NPT / hose 1/2"; 1/2" - 14 NPSM
10-13252-103-BW	4.0 GPM Baitwell, 12V	13L/min / 3.5 GPM	N/A	10 A	3/8" NPT / hose 1/2", 1/2" NPT / hose 3/4"; 1/2" NPT, 3/4" hose
10-13252-107-BW	5.2 GPM Baitwell, 12V	20L/min/ 5.2 GPM	N/A	15 A	GHT, 1/2" NPT x 3/4" hose



AERATING HEADS

Spray head assemblies can be custom made to required fit, size and flow capacity. A variety of shapes, configuration and options allow us to build these aerating heads to your specifications. Prototyping kits available. Shown here are some of the more popular sizes and configurations.

Order No.	Description
70195	Valve Assembly – overall length 5¾", two ¾" barbs, shut off valve
90061	Aerator Head – overall length 9"
90191-00	Aerator Head – overall length 13¾" thru-hull, one shut off valve
90261	Aerator head – 2 piece assembly, 8" spray bar with ¾" barb and 6" shut off assembly with ¾" barb and ¾" thru-hull
90331	Aerator Head – overall length 12¾", ¾" thru-hull, one shut off valve
90511	Aerator head – overall length 9¾", ¾" thru-hull, one shut off valve
90681-00	Aerator head – overall length 10½", ¾" barb, shut off valve w/bracket
90791	Aerator head – overall length 6¾", ¾" thru-hull, shut off valve

THRU-HULLS

Super tough and durable molded UV stabilized glass coupled polypropylene thru-hulls will not corrode or discolor and are not susceptible to electrolysis.

Order No.	Description
75035-00	¾" 90° – white
75095	¾" white
75125	1½" white

ACCESSORIES

Order No.	Description
71245	Transom Shims

Order No.	Description
74105	Strainer

Order No.	Description
77125	Intake Filter





FIP DC Pumps for Bilge, Deckwash & Refueling



With their high level of flexibility, these pumps are ideally suited for use in boats as bilge and deckwash pumps, fresh water pumps, refuelling pumps for oil and diesel. These pumps may be combined with a vacuum switch for automatic operation. Capacities vary from max 15 l/min to 55 l/min, allowing the proper matching of the pump to the application. All motors are heavy duty to provide long service life even under heavy use. Available in 12 or 24 volts.



CE marked according to following standards:

F2P10-19, F3B-19, F4B-19, F4B-11

EN50082-1: 1992/Generic EMS Standard

EN55014: 1993/Radio disturbance

IEC801-2: 1984/Electrostatic Discharge

IEC801-3: 1984/Radiated Immunity Test

ISO8846: Small Craft – Electrical devices – Protection against ignition of surrounding flammable gases

ISO8849: Small Craft – Electrically operated bilge pumps

ISO10133: Small Craft – Electrical systems – Extra-low voltage d.c. installations

F5B-19 12/24 V

EN55014: 1993/Radio disturbance



F2P10-19 – CAPACITY 15 L/MIN 4GPM

Fully equipped, self-priming multipurpose pump operating on a simple and uncomplicated principle. Ideal for pumping water, oils and chemicals.

Order No.	Description	Body	Impeller	Seal	Connection	Length	Width	Height	Weight
10-24180-1	F2P10-19, 12V	PTMT	09-1077B-9	Lip seal	½" hose	172 mm – 6.8"	117 mm – 4.6"	78 mm	1,6 kg – 3.5 lbs
*10-24886-02	F2P10-19, 24V	PTMT	09-1077B-9	Lip seal	½" hose	172 mm – 6.8"	117 mm – 4.6"	78 mm	1,6 kg – 3.5 lbs

* Replaces 10-24180-2



F3B-19 – CAPACITY 21 L/MIN 5.5 GPM

Perfect for bilge pumping, deckwash, water circulation, oil and diesel refuelling at dockside service, etc.

Order No.	Description	Body	Impeller	Seal	Connection	Length	Width	Height	Weight
10-24516-03	F3B-19, 12V	Bronze	09-843S-9	Lip seal	¾" NPT	170 mm – 6.7"	113 mm – 4.4"	82 mm – 3.22"	2 kg – 4.5 lbs
10-24516-04	F3B-19, 24V	Bronze	09-843S-9	Lip seal	¾" NPT	170 mm – 6.7"	113 mm – 4.4"	82 mm – 3.22"	2 kg – 4.5 lbs



F3B-19 OIL CHANGE – CAPACITY 21 L/MIN 5.5 GPM

Reversible rubber impeller pump with integrated quick reversing switch. Designed to remove old oil from the engine/fill new oil back into the engine.

Order No.	Description	Body	Impeller	Seal	Connection	Length	Width	Height	Weight
10-24760-03	F3B-19 Oil change, 12V	Bronze	09-843S-9	Lip seal	¾" NPT	70 mm – 6.7"	113 mm – 4.4"	115 mm – 4.5"	2,1 kg – 4.5 lbs
10-24760-04	F3B-19 Oil change, 24V	Bronze	09-843S-9	Lip seal	¾" NPT	70 mm – 6.7"	113 mm – 4.4"	115 mm – 4.5"	2,1 kg – 4.5 lbs



F38B-19 – CAPACITY 35 L/MIN 9 GPM

Perfect for bilge pumping, deckwash, water circulation, oil and diesel refuelling at dockside service, etc.

Order No.	Description	Body	Impeller	Seal	Connection	Length	Width	Height	Weight
10-24727-03	F38B-19, 12V	Bronze	09-824P-9	Lip seal	Hose 1" / ½" NPT	180 mm – 7"	120 mm – 4.72"	90 mm – 3.54"	3 kg – 6.6 lbs
10-24727-04	F38B-19, 24V	Bronze	09-824P-9	Lip seal	Hose 1" / ½" NPT	180 mm – 7"	120 mm – 4.72"	90 mm – 3.54"	3 kg – 6.6 lbs



F4B-19 – CAPACITY 48 L/MIN 12.5 GPM

Perfect for bilge pumping, deckwash, water circulation, oil and diesel refuelling at dockside service, etc.

Order No.	Description	Body	Impeller	Seal	Connection	Length	Width	Height	Weight
10-24689-03	F4B-19, 12V	Bronze	09-824P-9	Lip seal	Hose 1" / ½" NPT	202 mm – 8"	120 mm – 4.72"	90 mm – 3.54"	3 kg – 6.6 lbs
10-24689-04	F4B-19, 24V	Bronze	09-824P-9	Lip seal	Hose 1" / ½" NPT	202 mm – 8"	120 mm – 4.72"	90 mm – 3.54"	3 kg – 6.6 lbs



F4B-11 ULTRA BALLAST – CAPACITY 52 L/MIN 13.5 GPM SKI/WAKEBOARD

Designed to quickly fill or, when reversed, drain a ballast tank at a rate of more than 45 l/min (12 GPM).

Capable of pumping fresh or sea water the pump's robust design can handle the rigors of continuous duty usage, is reversible, and has a built in thermal overload for added protection. Polarity reversing switch kit 09-47196 available as accessory. *Note! Only for waterhandling.*

Order No.	Description	Body	Impeller	Seal	Connection	Length	Width	Height	Weight
10-24690-03EZ	F4B-11 Ultra Ballast, 12 V	Bronze	09-824P-1	Lip seal	Hose 1" / ½" NPT	202 mm – 8"	120 mm – 4.72"	90 mm – 3.54"	3 kg – 6.6 lbs
10-24690-04EZ	F4B-11 Ultra Ballast, 24 V	Bronze	09-824P-1	Lip seal	Hose 1" / ½" NPT	202 mm – 8"	120 mm – 4.72"	90 mm – 3.54"	3 kg – 6.6 lbs
09-824P-1EZ	Impeller								



F5B-19 – CAPACITY 55 L/MIN 14.5 GPM

For bilge pumping, deckwash, water circulation, oil and diesel refuelling at dockside service, etc.



Order No.	Description	Body	Impeller	Seal	Connection	Length	Width	Height	Weight
10-24188-4	F5B-19, 12 V	Bronze	09-1027B-9	Mech. seal	3/4" NPT	258 mm – 10.15"	131 mm – 5.15"	120 mm – 4.72"	8kg/ 17.5lbs
10-24188-5	F5B-19, 24 V	Bronze	09-1027B-9	Mech. seal	3/4" NPT	258 mm – 10.15"	131 mm – 5.15"	120 mm – 4.72"	8kg/ 17.5lbs

GEAR PUMP WITH OIL CHANGE KIT

Light and compact oil change pump with pump body and gears made of PTFE.

Complete with oil dip stick extraction tube 6 and 8 mm (0.236" and 0.315"). 180 cm (70.9") connection wires with battery clamps.

Port connection: Outlet: 14 mm (0.551") hose Inlet: 8 mm (0.315") hose
 Self priming: Up to 1 m (3.28 feet)
 Capacity: 8 l/min (2.11 GPM)
 Dimension: 140 x 80 mm (5.51" x 3.15")
 Weight: 1.1 kg
 Fuse size 12V: 8 A
 Fuse size 24V: 6 A

Order No.	Description
80-47508-01	GP8-19 12V
80-47508-02	GP8-19 24V
65000	12V complete Oil Change Kit with pail



65000

PRESSURE AND CAPACITY DATA (BASED ON WATER AT 20°C/68°F)

F2P10-19					Ampere Draw	
Bar	kPa	psi	l/min	GPM	12 V	24 V
Count. Duty						
0	0	0	15.0	4.0	5.6	4.0
0.1	10	1.45	14.5	3.8	5.7	4.0
0.2	20	2.90	14.0	3.7	5.8	4.1
0.3	30	4.35	13.5	3.6	5.9	4.1
0.6	60	8.7	11.0	2.9	6.1	4.2
Intermittent Duty						
0.75	75	10.8	9.6	2.5	6.5	4.3
0.9	90	13.0	7.0	1.8	6.5	4.8
Fuse Required					15 A	8 A

F4B-19					Ampere Draw	
Bar	kPa	psi	l/min	GPM	12 V	24 V
Count. Duty						
0	0	0	48.0	12.7	12.2	6.5
0.1	10	1.45	45.0	11.9	12.3	6.7
0.2	20	2.9	44.5	11.7	12.2	6.8
0.3	30	4.35	41.0	10.8	13.1	7.1
0.6	60	8.7	34.0	9.0	14.9	7.5
Intermittent Duty						
0.9	90	13.0	25.0	6.6	16.5	7.8
1.2	120	17.4	11.0	2.9	18.3	8.8
Fuse Required					15 A	8 A

F3B-19					Ampere Draw	
Bar	kPa	psi	l/min	GPM	12 V	24 V
Count. Duty						
0	0	0	21.0	5.5	8.4	4.0
0.1	10	1.45	20.5	5.4	8.5	4.0
0.2	20	2.9	20.0	5.3	8.6	4.1
0.3	30	4.35	19.5	5.2	8.8	4.1
0.6	60	8.7	17.8	4.7	9.0	4.2
Intermittent Duty						
0.9	90	13.0	15.6	4.1	9.6	4.3
1.2	120	17.4	12	3.2	10.3	4.8
Fuse Required					15 A	8 A

F5B-19					Ampere Draw	
Bar	kPa	psi	l/min	GPM	12 V	24 V
Count. Duty						
0	0	0	55.0	14.5	23.2	11.9
0.3	30	1.45	49.4	13.1	24.2	12.8
0.6	60	8.7	39.9	10.5	25.1	13.3
0.9	90	13.0	30.1	8.0	26.2	14.0
1.2	120	17.4	19.3	5.1	28.0	14.7
1.5	150	21.76	9.3	2.4	29.8	15.3
Fuse Required					50 A	25 A
Recommended wire size					16 mm ²	6 mm ²

F38B-19					Ampere Draw	
Bar	kPa	psi	l/min	GPM	12 V	24 V
Count. Duty						
0	0	0	35.0	9.2	10.9	5.0
0.1	10	1.45	33.8	8.9	11.0	5.1
0.2	20	2.9	32.2	8.5	11.0	5.1
0.3	30	4.35	31.0	8.2	11.1	5.2
0.6	60	8.7	25.5	6.7	11.9	5.4
Intermittent Duty						
0.9	90	13.0	15.3	4.0	13.6	6.0
1.2	120	17.4	2.0	0.5	15.8	7.1
Fuse Required					15 A	8 A

Accessories

Polarity Reversing Switch Kit for Ultra Ballast Pump F4B-11

Order No.	Description
09-47196	Polarity Reversing Switch Kit

Vacuum Switch see page 44

Order No.	Description
09-45053	Vacuum Switch

Deckwash Kit

Order No.	Description
09-46553	Deckwash Kit



Circulation Pumps



CM-series – a line of compact magnetic driven centrifugal pumps which combine high flow rates with very low electric current consumption.

Suitable for fresh water, ethylene glycol and salt water circulation.

C090 – mechanical sealed pumps with a motor designed for continuous operation. Suitable for fresh water and ethylene glycol circulation.

CM90BL-series – magnetic driven centrifugal pump, fitted with a brushless electric motor with fewer wear parts for continuous operation with extra long service life. Suitable for circulation of glycol mixture or fresh water.



CE marked according to following standards:

CM10P7-1, CM30P7-1, CM90, C090P5-1, CM90BL

Recreational Craft Directive 94/25/EEC

ISO 8846: 1990/Small Craft - Electrical devices - Protection against ignition of surrounding flammable gases

(ISO 10133: 1994/Small Craft -Electrical systems - Extra low-voltage DC installations)

Electromagnetic Compatibility Directive 2004/108/EC

EN55014-1: 2006 Electromagnetic compatibility –

Requirements for household appliances, electric tools and similar apparatus – Part 1:Emission

EN55014-2: 1997 +A1: 2001 Electromagnetic compatibility –

Requirements for household appliances, electric tools and similar apparatus – Part 2:Immunity.

EN61000-6-3: 2007 Electromagnetic compatibility (EMC) –

Part 6-3: Generic standards – Emission standard for residential, commercial and light-industrial environments.

2004/104/EC: 2004 Annex1; paragraph 6.5, 6.6, 6.8 and 6.9.

CM10 & CM30

Pump body	PPA thermoplastic
Impeller	PPS thermoplastic
O-ring	EPDM
Shaft	Stainless steel
Magnet housing	PSU
Motor	12/24V DC enclosed (as per IP67) permanent magnet, ball bearing mounted motor, designed for continuous operation
Liquid	water/glycol mixture; max. 60% glycol, fresh and salt water
Liquid temp.	Min -40°C Max +100°C
Hose connection	Ø 16 mm (5/8") or 20 mm (3/4") hose. Note! CM30P7-1 with Ø 16 mm (5/8") available on request

Dimensions and weight

	CM10P7-1	CM30P7-1
Length	177 mm – 6.97"	177 mm – 6.97"
Width	68 mm – 2.68"	68 mm – 2.68"
Height	85 mm – 3.35"	85 mm – 3.35"
Weight	0.53 kg – 1.2 lbs	0.6 kg – 1.3 lbs



CM10 & CM30 Rebuild Kit

Order No.	Description
09-46551	Impeller cpl. CM10/30
36-503-023	Clamp Bracket



Ø 16 mm (5/8")

Order No.	Description	Capacity	Flexible cord
10-24501-03	CM10P7-1, 12V	15 l/min at 0.1 bar (4 GPM at 3.3 ft)	-
10-24501-04	CM10P7-1, 24V	15 l/min at 0.1 bar (4 GPM at 3.3 ft)	-
10-24503-03	CM30P7-1, 12V	20 l/min at 0.1 bar (5.2 GPM at 3.3 ft)	-
10-24503-04	CM30P7-1, 24V	20 l/min at 0.1 bar (5.2 GPM at 3.3 ft)	-
10-24486-03	CM10P7-1, 12V w. flexible cord	15 l/min at 0.1 bar (4 GPM at 3.3 ft)	04-36245-01
10-24486-04	CM10P7-1, 24V w. flexible cord	15 l/min at 0.1 bar (4 GPM at 3.3 ft)	04-36245-01
10-24488-03	CM30P7-1, 12V w. flexible cord	20 l/min at 0.1 bar (5.2 GPM at 3.3 ft)	04-46249-01
10-24488-04	CM30P7-1, 24V w. flexible cord	20 l/min at 0.1 bar (5.2 GPM at 3.3 ft)	04-36245-01

Ø 20 mm (3/4")

Order No.	Description	Capacity	Flexible cord
10-24502-03	CM10P7-1, 12V	18.5 l/min at 0.1 bar (5 GPM at 3.3 ft)	-
10-24502-04	CM10P7-1, 24V	18.5 l/min at 0.1 bar (5 GPM at 3.3 ft)	-
10-24504-03	CM30P7-1, 12V	26 l/min at 0.1 bar (6.9 GPM at 3.3 ft)	-
10-24504-04	CM30P7-1, 24V	26 l/min at 0.1 bar (6.9 GPM at 3.3 ft)	-
10-24487-03	CM10P7-1, 12V w. flexible cord	18.5 l/min at 0.1 bar (5 GPM at 3.3 ft)	04-36245-01
10-24487-04	CM10P7-1, 24V w. flexible cord	18.5 l/min at 0.1 bar (5 GPM at 3.3 ft)	04-36245-01
10-24489-03	CM30P7-1, 12V w. flexible cord	26 l/min at 0.1 bar (6.9 GPM at 3.3 ft)	04-46249-01
10-24489-04	CM30P7-1, 24V w. flexible cord	26 l/min at 0.1 bar (6.9 GPM at 3.3 ft)	04-36245-01

C090

Pump body	PA66 thermoplastic
Impeller	PA66 thermoplastic
Shaft	Stainless steel
Shaft seal	Mechanical seal
Motor	12/24 V DC enclosed (as per IP31) permanent magnet, ball bearing mounted motor, designed for continuous operation
Liquid	water/glycol mixture; max. 60% glycol, fresh water
Liquid temp.	Min -30°C Max +100°C
Hose connection	Ø 38 mm (1.1/2") hose
Dimensions and weight	

Length	211 mm – 8.3"
Width	117 mm – 4.6"
Height	110 mm – 4.56" from baseplate (totally 116 mm – 4.8")
Weight	1.75 kg – 3.8 lbs



Order No.	Description	Capacity
10-24190-1	C090P5-1, 12V	100 l/min at 0.1 bar (26.4GPM at 3.4 ft)
10-24190-2	C090P5-1, 24V	100 l/min at 0.1 bar (26.4GPM at 3.4 ft)



CM90

System pressure	-0,3 to +3.0 bar; stationary max. 4.0 bar	Input power	Max. 125W
Liquid	water/glycol mixture; max. 60% glycol, fresh and salt water	Dry running	30 minutes
Motor service life	More than 5,000 hours at nominal voltage 10,000 start/stops. Interchangeable motor.	Dimensions	244 mm (L) x 120 mm (W) x 150 mm (H)
Motor, voltage	Nominal 13.6V DC for use between 10-16V Nominal 27.2V DC for use between 20-32V	Ports	Ø 20 mm (¾") & Ø 38 mm (1½")
		Weight	3.0 kg (6.6 pounds)
		Body	PPA, glass-fiber reinforced
		Mounting	Separate universal bracket for flat surfaces

Ø 20 mm (¾")

Order No.	Description	Capacity
10-24750-09	CM90P7-1, 12V	50 l/min (17.2 GPM) at 0.25 bar
10-24750-10	CM90P7-1, 24V	50 l/min (17.2 GPM) at 0.25 bar

Ø 38 mm (1½")

Order No.	Description	Capacity
10-24664-09	CM90P7-1, 12V	90 l/min (23.7 GPM) at 0.25 bar
10-24664-10	CM90P7-1, 24V	90 l/min (23.7 GPM) at 0.25 bar



CM90BL

Pump Body	PPA	Dry running	Max 30 minutes
Impeller	PA12	Input Power	Max. 125W
Shaft	Stainless Steel	Mounting	Separate universal bracket for flat surfaces
Motor	Brushless 12/24 V DC enclosed (as per IP67) permanent magnet, ball bearing mounted motor, designed for continuous operation	Dimensions and weight	
Liquid	Water/glycol mixture; max. 60% glycol, fresh water	Length	Ø 20 mm Ø 38 mm
Liquid temp	Min -40°C Max +100°C	Width	273.5 mm 272 mm
System pressure:	2,5 bar max	Height	121 mm 121 mm
Port size	Ø 20 mm (¾") & Ø 38 mm (1½")	Weight	141 mm 150 mm
			Weight 3.0 kg (6.6 lbs) with bracket, 2.8 kg (6.2 lbs) without bracket 3.0 kg (6.6 lbs) with bracket, 2.8 kg (6.2 lbs) without bracket

Ø 20 mm (¾")

Order No.	Description	Capacity 0,1 bar	Capacity 0,25 bar
10-24901-01	CM90P7-1 BL, 12V	55 l/min at 0.1 bar (14.5 GPM at 8.2 ft)	50 l/min at 0.25 bar (13.2 GPM at 8.2 ft)
10-24901-02	CM90P7-1 BL, 24V	55 l/min at 0.1 bar (14.5 GPM at 8.2 ft)	50 l/min at 0.25 bar (13.2 GPM at 8.2 ft)

Ø 38 mm (1½")

Order No.	Description	Capacity 0,1 bar	Capacity 0,25 bar
10-24898-01	CM90P7-1 BL, 12V	115 l/min at 0.1 bar (30.4 GPM at 8.2 ft)	90 l/min at 0.25 bar (23.8 GPM at 8.2 ft)
10-24898-02	CM90P7-1 BL, 24V	115 l/min at 0.1 bar (30.4 GPM at 8.2 ft)	90 l/min at 0.25 bar (23.8 GPM at 8.2 ft)



Waste Water Handling & Marine Toilets



From a name you can trust, the AquaT™ toilet provides the comfort and convenience of a land-based lavatory at sea — a marine toilet that flushes as quietly as a toilet on land.

In combination with the Viking Power 16 or 32 and a Grey Water Tank you will have a complete waste water handling system.



CE marked according to following standards:

Viking Power

Recreational Craft Directive 94/25/EEC

ISO8846: Small Craft – Electrical devices – Protection against ignition of surrounding flammable gases

ISO10133: Small Craft – Electrical systems – Extra-low voltage d.c. installations

ISO8849: Small Craft – Electrically operated bilge pumps

Electromagnetic Compatibility Directive 89/336/EEC

EN55014: 1993/Radio disturbance

AquaT Silent Electric, Standard Electric & Premium

Recreational Craft Directive 94/25/EEC

ISO8846: Small Craft – Electrical devices – Protection against ignition of surrounding flammable gases

Electromagnetic Compatibility Directive 89/336/EEC

EN55014: 1993/Radio disturbance



VIKING POWER 16

A modern, single-chamber, self-priming diaphragm pump that can be set up in several different pump/motor configurations. It is easy to install anywhere after the drain outlet in the wastewater system or as a bilge pump in any leisure craft – new or used.

Its non-choke valves mean that no in-line filters are necessary. The pump can be run dry, and it can also handle a mixture of air and water without difficulty. The Viking Power 16 is self-priming up to a height of 3 meters.

With its low pulse and muffled rubber bracket, this pump offers quiet operation. Specifically designed to pump waste water, the Viking Power 16 has been built to last, and engineered for easy maintenance. When it comes time to replace the premium grade reinforced nitrile rubber diaphragm, you can put in a spare without even removing the pump from the system. Delivered with 1" hose and 3/4" hose 1/2" BSP KlickTite™ XL connectors. 90° KlickTite™ XL connectors available as extra accessory.



Now with double check valves for improved pumping action

Motor	2.3 amp (12V), 1.2 amp (24V) at 0.1 bar 12/24V DC (with built-in thermal protection)
Body	Nylon, glass-fiber reinforced
Valves	Nitrile rubber
Diaphragm	Reinforced nitrile rubber
Length	186 mm – 7.3"
Width	235/181 mm – 9.3"/7.1"
Height	118/204 mm – 4.6/8"
Weight	2.6 kg – 5.7 lbs

Order No.	Description	Capacity, open flow	Capacity at 0.1 bar	Max lift	Max head	Connection
10-13350-03	Viking Power 16, 12V	16 l/min – 4.2 GPM	15 l/min – 4.0 GPM	3 m – 9.8 ft	3 m – 9.8 ft	KlickTite™ XL connectors for 1" hose or 3/4" hose and 1/2" BSP threads; straight and 90° (optional)
10-13350-04	Viking Power 16, 24V	16 l/min – 4.2 GPM	15 l/min – 4.0 GPM	3 m – 9.8 ft	3 m – 9.8 ft	
01-36035	Slidering					
09-47148	Diaphragm kit					
09-47149	Body kit					
01-36035	Retainer Clip (bulk)					
01-36192	Check Valve					



GREY WATER TANK

The Grey Water Tank is designed to be used as collection tank for waste water from showers, sinks, dishwashing machines, etc with 19 mm, 25 mm and 38 mm inlet ports, and 19 mm and 25 mm outlet ports. The tank includes an Ultima Switch for automatic operation and is easy to connect to any 12V/24V pump up to 20 amp. The tank is prepared for Viking Power 16, with pre-drilled holes for the pump.

Dimensions 185x280x340 mm

Order No.	Description
09-13384	Grey Water Tank, excl. Viking Power 16
10-13350-03-003	Grey Water Tank, & Viking Power 16 Combo

Ventilation

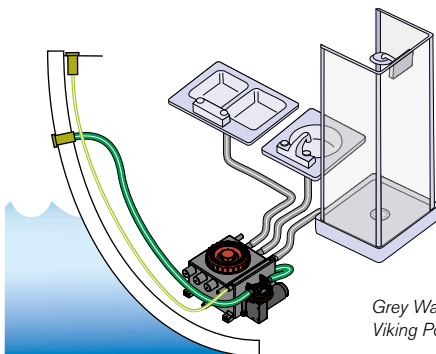

Grey Water Tank with Viking Power 16

Like the Viking Power 16, this pump has been engineered with a ball-bearing supported transmission for long service life. The pump cannot only be run dry, it can also handle a mixture of air and water without difficulty. The Viking Power 32/Vacuum provides maximum flow of 32 l/min and is self-priming up to a height of 2.5 m for VP 32 or 5 m for VP Vacuum. Although powered by an electric motor, this pump can also be cranked by hand in case of an emergency.

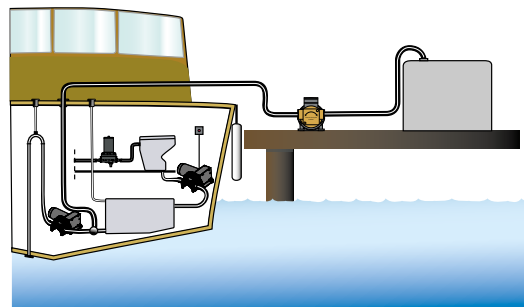

VIKING POWER 32

The Viking Power 32 and Viking Power Vacuum diaphragm pumps have been designed to meet the rigorous demands of the world's leading manufacturers of boats, recreational vehicles and busses. Thanks to its single-chamber design and non-choke valves, the Viking Power 32 can be used to pump un-macerated sewage to a holding tank or transfer it onwards to a septic tank.



Motor	3.3 amp (12V), 1.6 amp (24V) at 0.1 bar 12/24V DC (with built-in thermal protection)
Body	Nylon
Valves	Nitrile rubber
Diaphragm	Reinforced nitrile rubber
Length	277 mm – 10.9"
Width	264 mm – 10.4"
Height	192 mm – 7.6"
Weight	5.0 kg – 11.0 lbs

Order No.	Description	Capacity, open flow	Capacity at 0.1 bar	Max lift	Max head	Connection
10-13373-03	Viking Power 32, 12V	32 l/min – 8.5 GPM	30 l/min – 7.9 GPM	2.5 m – 8.2 ft	4 m – 13.1 ft	38 mm / 1½"
10-13373-04	Viking Power 32, 24V	32 l/min – 8.5 GPM	30 l/min – 7.9 GPM	2.5 m – 8.2 ft	4 m – 13.1 ft	38 mm / 1½"
01-36051	Rubber valve					

VIKING POWER VACUUM

The Viking Power Vacuum has double check-valves and can therefore also be used in vacuum toilet systems. Naturally, pumping ordinary shower or sink drain water or bilge water is no problem for either pump.



Motor	3.3 amp (12V), 1.6 amp (24V) at 0.1 bar 12/24V DC (with built-in thermal protection)
Body	Nylon
Valves	Nitrile rubber
Diaphragm	Reinforced nitrile rubber
Length	357 mm – 14"
Width	271 mm – 10.7"
Height	192 mm – 7.6"
Weight	5.1 kg – 11.2 lbs

Order No.	Description	Capacity, open flow	Capacity at 0.1 bar	Max lift	Max head	Connection
10-13373-07	Viking Power Vacuum, 12V	24 l/min – 6.3 GPM	22 l/min – 5.8 GPM	5 m – 16.4 ft	4 m – 13.1 ft	38 mm / 1½"
10-13373-08	Viking Power Vacuum, 24V	24 l/min – 6.3 GPM	22 l/min – 5.8 GPM	5 m – 16.4 ft	4 m – 13.1 ft	38 mm / 1½"



TA3P10-19

The TA3P10-19 macerator pump takes care of toilet waste. A rotary cutter shreds waste before it is pumped into or out from the holding tank. The pump should be connected as close as possible to the holding tank discharge outlet or the bowl discharge outlet. Note! Use unbleached lavatory paper only.

Motor	12/24V DC (with built-in thermal protection)	Length	230 mm – 9.06"
Body	Phenol Plastic (PF)	Width	108 mm – 4.25"
Impeller	Nitrile 09-10525-9	Height	82 mm – 3.23"
Housing	Thermoplastic Polyester (PET)	Weight	1.9 kg – 4.2 lbs
Shaft	Stainless Steel		
Seal	Lip Seal		

Order No.	Description	Capacity at 0.2 bar (6.7 ft)	Inlet Connection	Amperage	Fuse size	Outlet Connection
10-24453-01	TA3P10-19, 12V	37 l/min – 10 GPM	1 1/2" (dia 38 mm) hose or 1 1/2"NPT	15 A	20 A	1" (25.4 mm) hose
10-24453-02	TA3P10-19, 24V	37 l/min – 10 GPM	1 1/2" (dia 38 mm) hose or 1 1/2"NPT	7 A	12 A	1" (25.4 mm) hose



09-10525-9

SPARE PARTS

Order No.	Description
09-45595	Rebuild kit



AQUAT™ MARINE TOILETS

Available in a wide variety of different versions marketed under four basic models — standard, silent and premium electric-powered or manual — the AquaT™ marine toilet has been designed to meet virtually every conceivable lavatory installation situation onboard.

Priced competitively, the fine finish and well thought-through design of these toilets is remarkable. Made from white vitreous porcelain, and with corrosion resistant parts throughout, the AquaT™ marine toilet, is quiet, robust and easy to clean.

Most models can be ordered with standard, bevelled or low profiles in order to fit almost any hull and bulkhead configuration, and all are available in either compact or comfort versions so you can outfit your marine lavatory with the perfect-sized toilet, no matter what the layout.

The standard electric model is equipped with a combined pump unit for disposal and flushing. It is easy to install and an economical choice of electrical toilet.

The silent and premium electric models are shipped with well-proven Aqua Jet diaphragm pumps in either 12V or 24V versions, and the manual version incorporates an ergonomically designed, hand-powered piston pump that can be mounted for either left-hand or right-hand use.

It is probably fair to think of most toilets as commonplace products, but look at the features and you are sure to see that the AquaT™ is far from ordinary. Quiet, hygienic and reliable, the AquaT™ marine toilet is perfect for almost any marine toilet room.

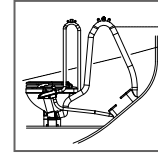

Toilet mounted below the waterline and discharging overboard.

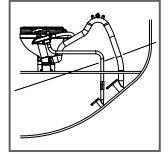

Toilet mounted above the waterline and discharging overboard.

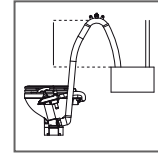

Toilet waste discharging into holding tank, discharging elbow below top of the holding tank at any time.

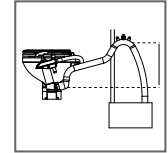

Toilet waste discharging into holding tank, discharging elbow always above top of the holding tank.

Round



Manual Compact
80-47229-01 right view (shown above)
80-47229-011 left view

Oval



Manual Comfort
80-47230-01



Standard Electric Compact
80-47435-01, 12V
80-47435-02, 24V



Standard Electric Comfort
80-47436-01, 12V
80-47436-02, 24V



Silent Electric Compact
80-47231-01, 12V
80-47231-02, 24V



Silent Electric Comfort
80-47232-01, 12V
80-47232-02, 24V

AQUAT™ MANUAL

Order No.	Description	Net Weight	A	B	C	D	E	F
80-47229-01	Compact	9,6 kg 21 lbs	345 mm 13.6"	650 mm 25.6"	215 mm 8.5"	425 mm 16.7"	450 mm 17.7"	170 mm 6.7"
80-47230-01	Comfort	11 kg 24 lbs	340 mm 13.4"	705 mm 27.8"	275 mm 10.8"	490 mm 19.3"	470 mm 18.5"	185 mm 7.3"

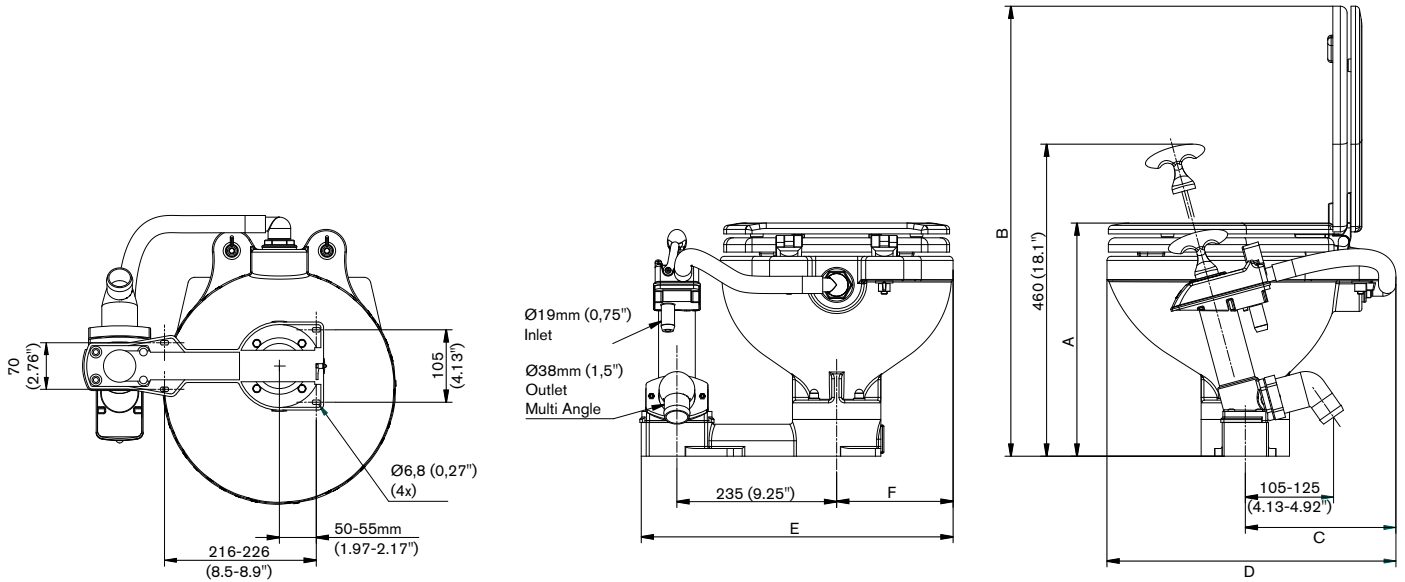

AQUAT™ SILENT ELECTRIC

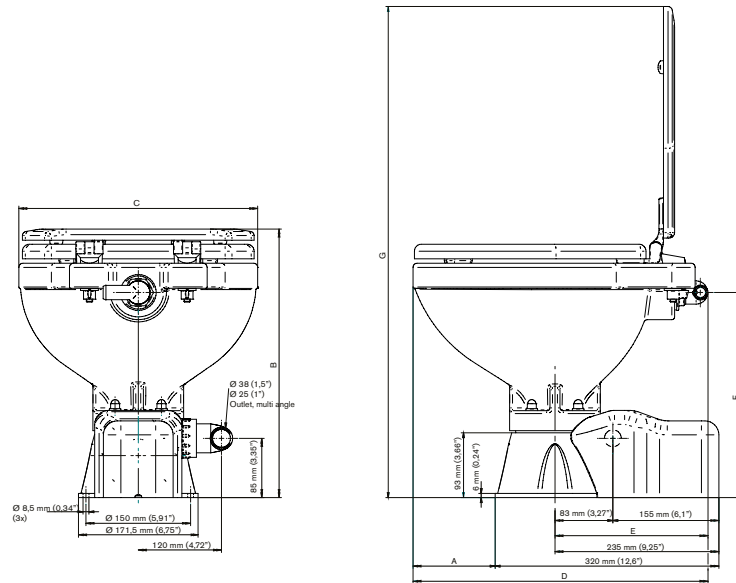

Order No.	Description	Net Weight	A	B	C	D	E	F	G
80-47231-01	Compact, 12V	9.6 kg 21 lbs	110 mm 4.7 inch	395 mm 15.4 inch	335 mm 13.2 inch	435 mm 17.2 inch	215 mm 8.5 inch	290 mm 11.4 inch	705 mm 27.7 inch
80-47231-02	Compact, 24V	9.6 kg 21 lbs	110 mm 4.7 inch	395 mm 15.4 inch	335 mm 13.2 inch	435 mm 17.2 inch	215 mm 8.5 inch	290 mm 11.4 inch	705 mm 27.7 inch
80-47232-01	Comfort, 12V	11 kg 24 lbs	110 mm 7.5 inch	385 mm 15.2 inch	365 mm 14.4 inch	490 mm 19.3 inch	275 mm 10.8 inch	280 mm 11.0 inch	760 mm 29.7 inch
80-47232-02	Comfort, 24V	11 kg 24 lbs	110 mm 7.5 inch	385 mm 15.2 inch	365 mm 14.4 inch	490 mm 19.3 inch	275 mm 10.8 inch	280 mm 11.0 inch	760 mm 29.7 inch

AQUAT™ STANDARD ELECTRIC

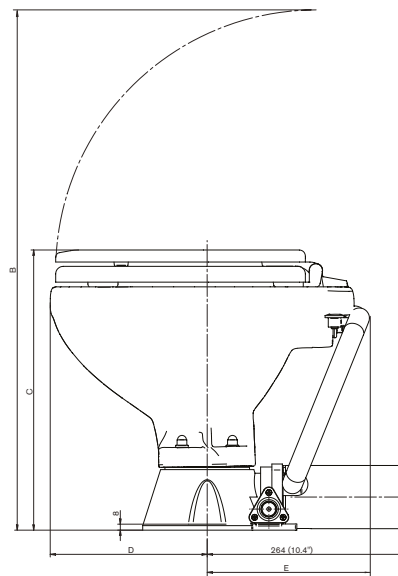
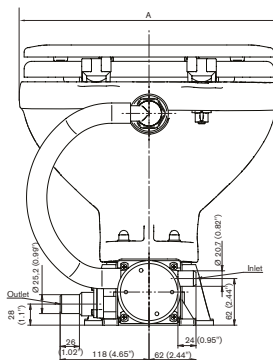
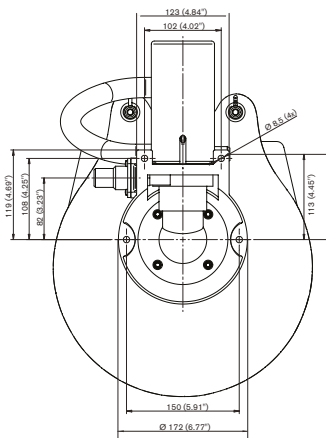

Order No.	Description	A	B	C	D	E
80-47435-01	Std. electric compact, 12V	345 /	692 /	373 /	209 /	216 /
80-47435-02	Std. electric compact, 24V	13.6"	27.2"	14.7"	8.23"	8.5"
80-47436-01	Std. electric comfort, 12V	366 /	747 /	380 /	220 /	275 /
80-47436-02	Std. electric comfort, 24V	14.4"	29.4"	15"	8.66"	10.8"

ACCESSORIES

Vented Loop

Order No.	Description
81-47237-01	Vented Loop, ¾"
81-47237-02	Vented Loop, 1"
81-47237-03	Vented Loop, 1½"



Vacuum valve - Siphon breaker

Order No.	Description
09-47316-01	Siphon Breaker, Spud Size 12 mm
09-47316-02	Siphon Breaker, Spud Size 16 mm
09-47316-03	Siphon Breaker, Spud Size 19 mm
09-47316-04	Siphon Breaker, Spud Size 22 mm
09-47316-05	Siphon Breaker, Spud Size 25 mm
09-47316-06	Service Kit



Y-valve

Order No.	Description
81-47238-01	Y-valve 1½" Inner diameter 1" Straight



Control Panel - Standard Electric Toilets 12V/24V

Order No.	Description
81-36105-01	Control Panel Standard Electric Toilets 12V/24V



Control Panel - Macerator Electric Toilet 12V/24V

Order No.	Description
81-47520-01	Control Panel Macerator Electric Toilet 12V/24V



Conversion Kit

Order No.	Description
81-47240-01	Conversion kit 12V
81-47240-02	Conversion kit 24V



Flush 2.4 Pump

Order No.	Description
10-24677-01	Flush 2.4 Pump, 12V
10-24677-02	Flush 2.4 Pump, 24V



Solenoid

Order No.	Description
81-47301-01	Solenoid valve 12V
81-47301-02	Solenoid valve 24V



Viking Power 32

Order No.	Description
10-13373-03	Viking Power 32, 12V
10-13373-04	Viking Power 32, 24V



Viking Universal

Order No.	Description
10-13530-01	Viking Universal with connection diameter 38 mm (1½")
09-36250	Viking Universal Through Deck Kit



SPARE PARTS

Order No.	Description
81-47239-01	Manual pump assembly
81-47241-01	Wooden Seat Compact
81-47241-02	Wooden Seat Comfort & Premium
81-47242-01	Gasket kit, all gaskets in the manual toilet
81-47243-01	Plastic base, plastic base and tap with the ring for manual toilet
81-47244-01	Plastic handle kit, only the plastic handle for manual toilet
81-47245-01	Bowl Compact
81-47245-02	Bowl Comfort
81-47245-03	Bowl Low
81-47245-04	Bowl Low. Bev
81-47245-05	Bowl Std.
81-47245-06	Bowl Std. Bev
81-47246-01	Intake elbow, inlet pipe gasket and nut for manual and silent electric versions
81-47246-02	Outlet elbow, outlet pipe gasket and plastic nut
81-47246-03	Intake elbow, inlet pipe gasket and plastic nut for Premium versions
81-47247-01	Base group (silent electric and premium versions)
81-47248-01	12V Motor group (silent electric and premium versions)
81-47248-02	24V Motor group (silent electric and premium versions)
81-47267-01	Hinge set
81-47268-01	Base gasket kit
81-47269-01	Flush handle kit
81-47273-01	Outlet elbow, Silent & Premium
81-47274-01	Bowl gasket



Radial Blowers & Marine Water Heaters



CE marked according to following standards:

AirV – Extra Heavy Duty Radial Blowers
ISO 9097:1991 Marine (Small craft, Electrical fans)
ISO 8846:1990 (Ignition protection)
ISO 10133: 2000 (Electrical systems)
EN 55014-1:2006 (2004/108EC)

AquaH - Marine Water Heaters
LOW VOLTAGE (LVD) DIRECTIVE 2006/95/EC
• EN 60335-1 (2008):
• EN 60335-2-21 (02-2004) + A1 (07-2005) + EC (01-2008):
ELECTROMAGNETIC COMPATIBILITY (EMC) DIRECTIVE - 2004/108/EC
• EN 55014 – 1 (1999) + A1 (2000) + A2 (2003)
• EN 55014 – 2 (1998) + A1 (2002)

AirV extra heavy duty radial blowers for marine engine compartment ventilation prior to start up. The blowers can be used for air intake or extraction in bilges, galleys, accommodation and other compartments.

AquaH is an innovative series of AISI 316 stainless steel water heaters, with a storage capacity of 22 up to 80 litres (5.3 to 19.3 gal.). Dual heating as standard - electrical heating and indirect heating based on a second heat source, for example the cooling system from the Marine engine or generator set.



AIRV – EXTRA HEAVY DUTY RADIAL BLOWERS

Marine radial blowers designed for engine compartment ventilation prior to start up. Is suitable for air intake or extraction in bilges, galleys, accommodation and other compartments. Flange Mount and Flex Mount design with double ball bearing motor, high-impact anti-shock ABS body and shaft and screws in stainless steel.

Flange Mount

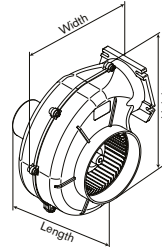
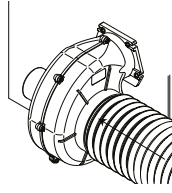

Flex Mount

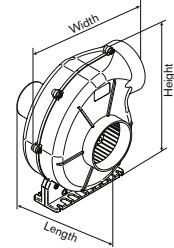
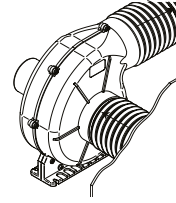

Order No.	Description	Capacity	Dimensions H x W x L	Port Connections		Current [Amp]
				Inlet	Outlet	
80-47416-01	AirV 3-280 Flange Mount, 12V	280 m ³ /h, 163 cfm	198 x 171 x 195 mm / 6.89 x 6.3 x 7.68"	Ø75 mm / Ø3"	92 x 80 / 3,62 x 3,15"	3.9
80-47416-02	AirV 3-280 Flange Mount, 24V	280 m ³ /h, 163 cfm	197 x 173 x 195 mm / 6.89 x 6.3 x 7.68"	Ø75 mm / Ø3"	92 x 80 / 3,62 x 3,15"	2.5
80-47417-01	AirV 4-550 Flange Mount, 12V	550 m ³ /h, 324 cfm	277 x 259 x 160 mm / 10.91 x 10.08 x 6.61"	Ø100 mm / Ø4"	146 x 118 / 5,75 x 4,65"	12.5
80-47417-02	AirV 4-550 Flange Mount, 24V	550 m ³ /h, 324 cfm	277 x 259 x 160 mm / 10.91 x 10.08 x 6.61"	Ø100 mm / Ø4"	146 x 118 / 5,75 x 4,65"	7
80-47418-01	AirV 4-750 Flange Mount, 12V	750 m ³ /h, 441 cfm	277 x 257 x 181 mm / 10.91 x 10.08 x 6.73"	Ø150 mm / Ø6"	146 x 118 / 5,75 x 4,65"	14.5
80-47418-02	AirV 4-750 Flange Mount, 24V	750 m ³ /h, 441 cfm	277 x 257 x 181 mm / 10.91 x 10.08 x 6.73"	Ø150 mm / Ø6"	146 x 118 / 5,75 x 4,65"	8.5
80-47419-02	AirV 4-1000 Flange Mount, 24V	1000 m ³ /h, 589 cfm	278 x 258 x 203 mm / 10.91 x 10.08 x 8.19"	Ø150 mm / Ø6"	146 x 118 / 5,75 x 4,65"	15.5
80-47420-01	AirV 4-550 Flex Mount, 12V	550 m ³ /h, 324 cfm	296 x 257 x 161 mm / 11.61 x 10.08 x 6.61"	Ø100 mm / Ø4"	Ø110 mm / Ø4,33"	12.5
80-47420-02	AirV 4-550 Flex Mount, 24V	550 m ³ /h, 324 cfm	296 x 257 x 161 mm / 11.61 x 10.08 x 6.61"	Ø100 mm / Ø4"	Ø110 mm / Ø4,33"	7
80-47421-01	AirV 4-750 Flex Mount, 12V	750 m ³ /h, 441 cfm	297 x 257 x 182 mm / 11.61 x 10.08 x 6.61"	Ø150 mm / Ø6"	Ø110 mm / Ø4,33"	14.5
80-47421-02	AirV 4-750 Flex Mount, 24V	750 m ³ /h, 441 cfm	297 x 257 x 182 mm / 11.61 x 10.08 x 6.61"	Ø150 mm / Ø6"	Ø110 mm / Ø4,33"	8.5
80-47422-02	AirV 4-1000 Flex Mount, 24V	1000 m ³ /h, 589 cfm	296 x 257 x 201 mm / 11.61 x 10.08 x 8.19"	Ø150 mm / Ø6"	Ø110 mm / Ø4,33"	15.5
66302	3" Inline Blower 12V	158 cfm		3"	3"	3,5
66402	4" Inline Blower 12V	240 cfm		4"	4"	3,5
54124	Blower, Flange Mounted	112 CFM		3"	3"	5
54154	Blower, Remote Mount	112 CFM		3"	3"	5

AQUAH – MARINE WATER HEATERS

Stainless steel water heaters with dual heating as standard - electrical heating and indirect heating based on a second heat source, for example based on the cooling system from the Marine engine or generator set. AquaH is an innovative series of AISI 316 stainless steel water heaters, with a storage capacity of 22 up to 80 litres (5.3 to 19.3 gal.). The heaters are cased in AISI 304 stainless steel and is provided with a sturdy compact plastic end cover which also includes the mounting brackets.

Electrical heating elements are available in Incoloy at 500 & 1200 Watts allowing hot water production when engine heat is not available but when 230 volts or 120 volts AC is. Delivered with an adjustable safety thermostat for temperature adjustment while on electrical heating.



Order no	Description
56-47455-01	AquaH Marine Water Heater 1200W / 6 GAL 22L 220V BSP
56-47455-02	AquaH Marine Water Heater 1200W / 6 GAL 22L 120V NPT
56-47455-03	AquaH Marine Water Heater 500W / 6 GAL 22L 220V BSP
56-47455-04	AquaH Marine Water Heater 500W / 6 GAL 22L 120V NPT
56-47456-01	AquaH Marine Water Heater 1200W / 8 GAL 30L 220V BSP
56-47456-02	AquaH Marine Water Heater 1200W / 8 GAL 30L 120V NPT
56-47456-03	AquaH Marine Water Heater 500W / 8 GAL 30L 220V BSP
56-47456-04	AquaH Marine Water Heater 500W / 8 GAL 30L 120V NPT
56-47457-01	AquaH Marine Water Heater 1200W / 11 GAL 45L 220V BSP
56-47457-02	AquaH Marine Water Heater 1200W / 11 GAL 45L 120V NPT
56-47457-03	AquaH Marine Water Heater 500W / 11 GAL 45L 220V BSP
56-47457-04	AquaH Marine Water Heater 500W / 11 GAL 45L 120V NPT
56-47458-01	AquaH Marine Water Heater 1200W / 15 GAL 60L 220V BSP
56-47458-02	AquaH Marine Water Heater 1200W / 15 GAL 60L 120V NPT
56-47458-03	AquaH Marine Water Heater 500W / 15 GAL 60L 220V BSP
56-47458-04	AquaH Marine Water Heater 500W / 15 GAL 60L 120V NPT
56-47459-01	AquaH Marine Water Heater 1200W / 20 GAL 80L 220V BSP
56-47459-02	AquaH Marine Water Heater 1200W / 20 GAL 80L 120V NPT
56-47459-03	AquaH Marine Water Heater 500W / 20 GAL 80L 220V BSP
56-47459-04	AquaH Marine Water Heater 500W / 20 GAL 80L 120V NPT

ACCESSORIES

Order No.	Description
56-47464-01	AquaH Thermostat Water Mixer Kit BSP
56-47464-02	AquaH Thermostat Water Mixer Kit NPT

DIMENSIONS

Order no	Electrical supply	Storage capacity	Weight empty	A	B	C	D	E	F
	w	lt (gallons)	kg (lbs)	mm	mm	mm	mm	mm	mm
56-47455-01/02	1200	22	10	322	290	235	325	410	485
56-47455-03/04	500	(5.81)	(22)	12.7"	11.4"	9.25"	12.8"	16.1"	19.1"
56-47456-01/02	1200	30	11,5	322	290	370	325	545	620
56-47456-03/04	500	(7.93)	(25.4)	12.7"	11.4"	14.6"	12.8"	21.5"	24.4"
56-47457-01/02	1200	45	15	322	290	625	325	805	880
56-47457-03/04	500	(11.9)	(33.1)	12.7"	11.4"	24.6"	12.8"	31.7"	34.6"
56-47458-01/02	1200	60	17,3	322	290	810	325	990	1065
56-47458-03/04	500	(15.9)	(38.1)	12.7"	11.4"	31.9"	12.8"	39"	41.9"
56-47459-01/02	1200	80	20	322	290	1090	325	1270	1345
56-47459-03/04	500	(21.1)	(44.1)	12.7"	11.4"	42.9"	12.8"	50"	53"

Electric supply 220-240 V ~ 50 Hz or 120 V - 60 Hz
Water connections ½"

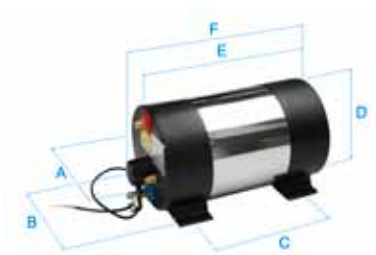

TYPICAL APPLICATION

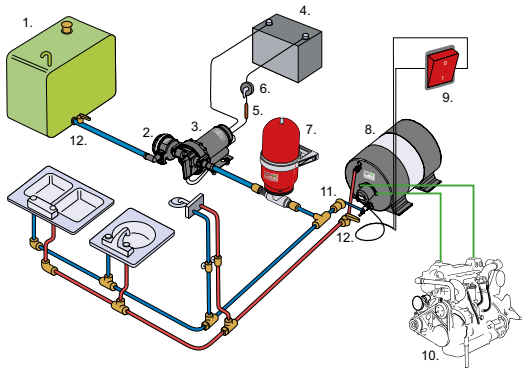

1. Water tank
2. PUMProtector inlet strainer
3. Aqua Jet water pressure pump
4. Battery
5. Fuse
6. Switch
7. Accumulator tank
8. Water heater
9. ON/OFF bipolar switch
10. Motor
11. Check valve
12. Shut-off valve

HEATING TIME

1200W

Order no	Electrical supply w	Storage capacity lt (gallons)	Water temperature in °C (°F)							
			20 (68)	25 (77)	30 (86)	35 (95)	40 (104)	45 (113)	50 (122)	55 (131)
56-47455-01/02	1200	22 (5.81)	6	12	19	25	31	38	44	51
56-47456-01/02	1200	30 (7.93)	8	17	26	34	43	52	61	69
56-47457-01/02	1200	45 (11.9)	13	26	39	52	65	78	91	104
56-47458-01/02	1200	60 (15.9)	17	34	52	69	87	104	122	139
56-47459-01/02	1200	80 (21.1)	23	46	69	93	116	139	162	186

Initial temperature 15°C

500W

Order no	Electrical supply w	Storage capacity lt (gallons)	Water temperature in °C (°F)							
			20 (68)	25 (77)	30 (86)	35 (95)	40 (104)	45 (113)	50 (122)	55 (131)
56-47455-03/04	500	22 (5.81)	15	30	46	61	76	92	107	122
56-47456-03/04	500	30 (7.93)	20	41	62	83	104	125	146	167
56-47457-03/04	500	45 (11.9)	31	62	94	125	156	188	219	251
56-47458-03/04	500	60 (15.9)	41	83	125	167	209	251	293	334
56-47459-03/04	500	80 (21.1)	55	111	167	223	279	334	390	446

Initial temperature 15°C



Photo: Munson

Impeller Pumps



Flexible impeller pumps provide an efficient solution to most raw water pumping needs. The pumps are self-priming and can pass fairly large solids without clogging or damaging the pumps. Designed for a number of applications on board.

Self-Priming Flexible Impeller Pumps

OPERATING PRINCIPLE



A vacuum is created as the flexible impeller vanes straighten upon leaving the cam, drawing liquid into the pump.



The rotating impeller carries liquid from the inlet to the outlet port. As a consequence of their design, flexible impeller pumps can pass fairly large solids.



When the flexible impeller vanes regain contact with the cam, they bend and the liquid is discharged from the pump in a uniform flow. Liquids can be pumped in the opposite direction by reversing the rotation of the pump.



HEAVY DUTY IMPELLER PUMP

A range of multipurpose bronze pumps. Compact design, raw water resistant pumps at an attractive price – with the renowned SPX Johnson Pump quality. These pumps are designed for a number of applications on board.

With excellent self-priming capability, these pumps are ideal as cooling water pumps for marine engines, bilge pumps, deckwash pumps, fresh water pumps, fuel transfer pumps and other applications. Also ideally suited on shore to empty septic tanks, to flush clean and to fill water tanks. Available in sizes from 3/8" to 1 1/2" (4 l/min to 279 l/min).

Vacuum switch (see page 45) as extra accessory for F8B-8 only.

Technical Specifications, Heavy Duty Impeller Pumps

Pump body	Bronze
Shaft	Stainless steel The shaft is mounted with permanently lubricated double ball bearings
Seal	Mechanical seal
Cam	Full or reduced
Connection	BSP or NPTF

HEAVY DUTY IMPELLER PUMPS



Order No.	Description	Impeller	Connection	Length	Width	Height	Weight	Drive Shaft Ø
10-24569-51	F35B-8	09-808B-1	3/8" NPT	109 mm – 4.29"	80 mm – 3.14"	30 mm – 1.18"	0.5 kg – 1.2 lbs	3/8"
10-24570-51	F4B-8	09-810B-1 09-810B-9	3/8" NPT	111 mm – 4.37"	80 mm – 3.15"	50 mm – 1.97"	0.8 kg – 1.8 lbs	3/8"
10-24571-51	F5B-8	09-1027B-1 09-1027B-9	3/4" NPT	151 mm – 5.95"	106 mm – 4.17"	50 mm – 1.97"	1.6 kg – 3.5 lbs	5/8"
10-24572-51	F7B-8	09-1028BT-1 09-1028B-9	1" NPT	170 mm – 6.69"	120 mm – 4.72"	50 mm – 1.97"	1.9 kg – 4 lbs	5/8"
10-13021-9	F8B-8	09-819B 09-819B-9	1 1/2" NPT	217 mm – 8.54"	160 mm – 6.3"	65 mm – 2.56"	5.9 kg – 13 lbs	1"
10-13021-95	US version 1 1/4" ports, 1" shaft keyed							
10-13021-96	US version 1 1/2" ports, 1" shaft keyed							

EXTRA HEAVY DUTY IMPELLER PUMPS

Whenever you need greater strength or service from a pump, use an extra heavy duty flexible impeller pump with separate bearing housing and mechanical seal for less wear and longer life. These pumps cover the entire range of marine applications and may be used as cooling water pumps, bilge pumps, deckwash pumps, emergency and fire fighting pumps, etc. Available in sizes from ¾" to 2 ½" (13 l/min to 625 l/min). Wearing parts are easily replaceable and service kits are available for all standard models.

Vacuum switch as extra accessory, see below.

Order No.	Description	Impeller	Connection	Length	Width	Height	Weight	Drive Shaft Ø
10-24210-5	F5B-3007	09-1027B-1 09-1027B-9-00	¾" NPT	195 mm – 7.68"	106 mm – 4.17"	88 mm – 3.46"	2,9 kg – 6.5 lbs	17 mm
10-24209-7	F7B-3007	09-1028BT-1 09-1028B-9	1" NPT	213 mm – 8.38"	120 mm – 4.72"	93 mm – 3.66"	3,1 kg – 6.9 lbs	17 mm
10-13024-1	F8B-3000 VF	09-819B-00 09-819B-9	1½" NPT	255 mm – 10.04"	152 mm – 5.98"	154 mm – 6.06"	7,6 kg – 16.5 lbs	1"
10-13026-7	F9B-3007	09-802B 09-814B	2" NPT	282 mm – 11.1"	192 mm – 7.56"	157 mm – 6.18"	9,3 kg – 21 lbs	1"
10-13175-01	F8B-3000 TSS	09-819B 09-819B-9	1½" NPT	255 mm – 10.04"	198 mm – 7.79"	151 mm – 5.94"	7,6 kg – 16.5 lbs	1"
10-13225-01	F9B-3000 VF	09-802B 09-814B	2" NPT	282 mm – 11.1"	152 mm – 5.98"	175 mm – 6.89"	9,3 kg – 21 lbs	1"
10-13177-01	F9B-3000 TSS	09-802B 09-814B	2" NPT	282 mm – 11.1"	200 mm – 7.87"	151 mm – 5.94"	9,3 kg – 21 lbs	1"



EXTRA HEAVY DUTY, HIGH FLOW, IMPELLER PUMPS

Order No.	Description	Impeller	Connection	Length	Width	Height	Weight	Drive Shaft Ø
10-13121-04	F95B-3007	09-820B	2½" NPT	354 mm – 13.93"	246/ 295 mm 9.68"/11.61"	226/ 201 mm 8.89"/7.91"	17,2 kg – 38 lbs	24 mm



VACUUM SWITCH

For automatic shut off operation to prevent pump damage.

The vacuum switch works with all self-priming impeller pumps and should be used for e.g. bilge pumping/emptying of tanks to prevent the pump from dry running. The vacuum switch automatically shuts the pump off when the bilge/tank is dry. With the switch fitted, you can start the pump by remote push button or manually by depressing lever on the switch.

Order No.	Description
09-45053	Vacuum Switch



PORT ADAPTOR KIT

Order No.	Description
09-45562	1½" BSP for F8B-3000/5000-VF, F8B-3000/5000-TSS
09-46557-01	2" BSP for F9B-3000/5600-VF and F9B-3000/5600-TSS

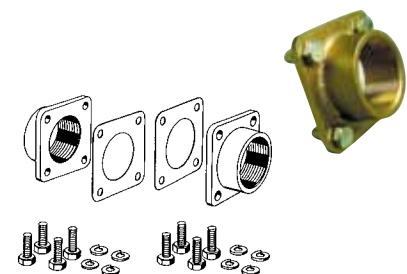



HEAVY DUTY ELECTRO-MAGNETIC CLUTCH PUMPS

With an electro-magnetic clutch you will have pumping power whenever needed, at a push of a button, without being at the pump. Combined with a vacuum switch (recommended for bilge pump application), the clutch will automatically disengage whenever the pump starts priming air, thereby preventing dry running and pump damage. Automatically controlled pumps are available in sizes from 1" to 2½" (20 l/min to 625 l/min), with clutches in 12 or 24 volts. Wearing parts are easily replaceable and service kits are available for all standard models.

Vacuum Switch as extra accessory, see page 45

Order No.	Description	Impeller	Connection	Length	Width	Height	Weight
10-24577-98	F7B-50017	09-1028B	1" NPT	156 mm – 6.14"	120 mm – 4.72"	93 mm – 3.66"	5.8 kg – 12.7 lbs
10-13022-98	F8B-50017	09-819B	1½" NPT	225 mm – 8.85"	160 mm – 6.29"	124 mm – 4.88"	9.9 kg – 22 lbs
10-13022-95	US version 1¼" ports*						
10-13022-96	US version 1½" ports**						



EXTRA HEAVY DUTY ELECTRO-MAGNETIC CLUTCH PUMPS

Order No.	Description	Impeller	Connection	Length	Width	Height	Weight
10-24116-98	F7B-5000	09-1028B	1" NPT	226 mm – 8.9"	120 mm – 4.72"	93 mm – 3.66"	6.9 kg – 15 lbs
10-13025-99	F8B-5000 VF	09-819B	1½" NPT	265 mm – 10.43"	152 mm – 5.98"	154 mm – 6"	11.9 kg – 26 lbs
10-13176-99	F8B-5000 TSS	09-819B	1½" NPT	265 mm – 10.43"	198 mm – 7.79"	151 mm – 5.94"	11.9 kg – 26 lbs
10-13027-99	F9B-5600	09-814B	2" NPT	290 mm – 11.42"	192 mm – 7.56"	157 mm – 6.18"	13.2 kg – 29 lbs
		09-802B					
10-13226-98	F9B-5600 VF	09-814B	2" NPT	290 mm – 11.4"	152 mm – 5.98"	175 mm – 6.88"	13.2 kg – 27 lbs
		09-802B					
10-13178-99	F9B-5600 TSS	09-814B	2" NPT	290 mm – 11.4"	200 mm – 7.87"	151 mm – 5.94"	13.2 kg – 27 lbs
		09-802B					



EXTRA HEAVY DUTY, HIGH FLOW ELECTRO-MAGNETIC CLUTCH PUMP

Order No.	Description	Impeller	Connection	Length	Width	Height	Weight
10-13143-98	F95B-5000	09-820B	2½" NPT	358 mm – 14.09"	246/295 mm	226/201 mm	21 kg – 46 lbs
					9.68"/11.61"	8.89"/7.91"	

Flange with 2½" BSP port adaptors (NPTF available on request)
The port adaptors can be fitted either vertically or horizontally

Technical Specifications, Clutch Pumps

Pump body	Bronze Connection for vacuum switch	Connection	BSP or NPTF
Shaft	Stainless steel The shaft is mounted with permanently lubricated double ball bearings	Clutch	Electro-magnetic 12/24 V DC
Seal	Mechanical seal	Pulley	2xA or 1xB-groove
Cam	Full or reduced	Pulley dia	ø178 mm / 7"

Electro-magnetic clutch, 12/24 V



CHOICE OF CLUTCH

Order No.	Description
0.3454.001	Electro-magnetic clutch, 12 V 2xA pulley
0.3454.002	Electro-magnetic clutch, 24 V 2xA pulley
0.3454.003	Electro-magnetic clutch, 12 V 1xB pulley
0.3454.004	Electro-magnetic clutch, 24 V 1xB pulley
0.3454.050	Coil 12V
0.3454.051	Coil 24V

F7B-9 FLANGE MOUNT

John Deere flange mount PTO drive style cooling pump. Fits RE47016, 4039D and 4045T flange mount engines.

Order No.	Description	Impeller
10-24398-01	F7B-9	09-1028BT-1
10-24389-02	F7B-9	09-1028BT-1



F7B-9 FLANGE MOUNT

John Deere, Kohler Flange mount PTO drive style cooling pump. Fits John Deere powertech GBL 6068TFM75/TFM Engines. Fits Kohler 40E02/33EF02, 65E02/55EF02, 30E02/20EF02, 99E02/80LF02

Order No.	Description	Impeller
10-24753-01	F7B-9	09-1028BT-1



F35B PEDESTAL STYLE

Gen set Engine cooling pump - pedestal style. Fits Onan engine and MAJB style engines. Fits universal 1.400000001, engine. Fits Arona, Nanni, Farymann, Fischer Panda and many more.

Order No.	Description	Impeller
10-35038-5	F35B-8027	09-808B-1
10-35038-5E	F35B-8027	09-808B-1



F5B-9 CRANKSHAFT

Crankshaft style cooling pump featured on older style small block GM marine engines. Easy to access impeller design.

Order No.	Description	Impeller
10-24228-1	F5B-9	09-1027B-10



F6B-9 CRANKSHAFT

Crankshaft style cooling pump featured on Indmar, Marine Power, Volvo, PCM engines. 15% more flow. Industry standard.

Order No.	Description	Impeller
*10-24915-01	F6B-9	09-812B-1

* Replaces 10-24805-01 + 10-24232-1



F7B-9 CRANKSHAFT

John Deere Crankshaft style pump. Featured on John Deere 4039D, 4045T and RE49556 Engines. Mounts to crankshaft pulley.

Order No.	Description	Impeller
10-24428-01	F7B-9	09-1028BT-1



Bronze Impeller Pump Performance Tables

Note! Reduced cam - 30-40% lower capacity
Impeller of nitrile - adjust total head approx. 30% down

F35B			700 rpm			900 rpm			1400 rpm			1750 rpm			2000 rpm			2500 rpm		
Bar	kPa	ft	kW	l/min	GPM	kW	l/min	GPM	kW	l/min	GPM	kW	l/min	GPM	kW	l/min	GPM	kW	l/min	GPM
0.3	30	10.1	0.06	5.2	1.4	0.09	6.8	1.8	0.13	11.2	3.0	0.16	14.0	3.7	0.18	16.0	4.2	0.18	20.5	5.4
0.6	60	20.1	0.09	4.6	1.2	0.09	6.2	1.6	0.13	10.6	2.8	0.16	13.7	3.6	0.18	15.8	4.1	0.18	19.6	5.2
1.0	100	33.5	0.09	4.0	1.1	0.09	5.6	1.5	0.18	9.2	2.4	0.18	11.8	3.1	0.18	13.6	3.6	0.18	17.0	4.5

F4B			700 rpm			900 rpm			1400 rpm			1750 rpm			2000 rpm			2500 rpm		
Bar	kPa	ft	kW	l/min	GPM	kW	l/min	GPM	kW	l/min	GPM	kW	l/min	GPM	kW	l/min	GPM	kW	l/min	GPM
0.3	30	10.1	0.06	12.0	3.2	0.09	15.0	4.0	0.13	23.0	6.0	0.17	27.0	7.1	0.18	30.5	8.1	0.18	34.5	9.1
0.6	60	20.1	0.09	11.0	2.9	0.09	14.0	3.7	0.13	21.0	5.4	0.17	25.0	6.6	0.18	28.0	7.4	0.18	33.0	8.7
1.0	100	33.5	0.09	9.0	2.4	0.09	11.0	2.9	0.18	18.0	4.8	0.18	22.0	5.8	0.18	25.0	6.6	0.18	29.5	7.8
1.5	150	50.3	0.09	4.5	1.2	0.09	7.0	1.8	0.18	13.5	3.6	0.18	17.0	4.5	0.18	20.0	5.3	0.24	25.0	6.6

F5B			700 rpm			900 rpm			1400 rpm			1750 rpm			2000 rpm		
Bar	kPa	ft	kW	l/min	GPM	kW	l/min	GPM	kW	l/min	GPM	kW	l/min	GPM	kW	l/min	GPM
0.3	30	10.1	0.13	16.0	4.2	0.18	21.0	5.5	0.37	33.0	8.7	0.37	41.0	10.8	0.37	46.0	12.2
0.6	60	20.1	0.13	15.0	4.0	0.18	20.0	5.3	0.37	32.0	8.5	0.37	39.5	10.4	0.37	45.0	11.9
1.0	100	33.5	0.13	14.0	3.7	0.18	19.0	5.0	0.37	30.0	7.9	0.37	37.0	9.8	0.37	42.0	11.1
1.5	150	50.3	0.13	13.0	3.4	0.18	17.0	4.5	0.37	27.0	7.1	0.37	33.5	8.9	0.37	38.0	10.0
2.0	200	67.1	-	-	-	-	-	-	0.37	22.0	5.8	0.37	28.5	7.5	0.37	33.0	8.07

F7B			700 rpm			900 rpm			1400 rpm			1750 rpm			2000 rpm		
Bar	kPa	ft	kW	l/min	GPM	kW	l/min	GPM	kW	l/min	GPM	kW	l/min	GPM	kW	l/min	GPM
0.3	30	10.1	0.37	36.0	9.5	0.37	46.0	12.2	0.75	74.0	19.6	0.75	98.0	25.9	0.75	107.0	28.3
0.6	60	20.1	0.37	34.0	9.0	0.37	44.0	11.6	0.75	72.0	19.0	0.75	96.0	25.4	0.75	104.0	27.5
1.0	100	33.5	0.37	29.0	7.7	0.37	40.0	10.6	0.75	67.0	17.7	0.75	87.0	23.0	0.75	98.0	25.9
1.8	180	60.4	0.37	21.0	5.5	0.37	30.0	7.9	0.75	57.0	15.1	0.75	73.0	19.3	0.75	84.0	22.2
2.5	250	83.8	-	-	-	-	-	-	0.75	37.0	9.8	1.1	52.0	13.7	1.1	63.0	16.6

F8B			700 rpm			900 rpm			1400 rpm			1750 rpm			2000 rpm		
Bar	kPa	ft	kW	l/min	GPM	kW	l/min	GPM	kW	l/min	GPM	kW	l/min	GPM	kW	l/min	GPM
0.3	30	10.1	0.37	87.0	9.5	0.75	114.0	30.1	1.1	188.0	50.0	1.5	241.0	63.7	1.5	279.0	73.7
0.6	60	20.1	0.37	80.0	9.0	0.75	107.0	28.3	1.1	180.0	47.6	1.5	233.0	61.6	1.5	270.0	71.3
1.0	100	33.5	0.37	73.0	7.7	0.75	101.0	26.7	1.1	177.0	46.8	1.5	228.0	60.2	1.5	264.0	69.7
1.8	180	60.4	-	-	-	1.1	70.0	18.5	1.1	148.0	39.1	2.2	203.0	53.6	2.2	242.0	63.4
2.5	250	83.8	-	-	-	-	-	-	1.1	108.0	28.5	2.2	166.0	43.9	2.2	208.0	55.0

F9B-5000			700 rpm			900 rpm			1400 rpm			1750 rpm			2000 rpm		
Bar	kPa	ft	kW	l/min	GPM	kW	l/min	GPM	kW	l/min	GPM	kW	l/min	GPM	kW	l/min	GPM
0.3	30	10.1	0.75	129.0	34.1	0.75	170.0	44.9	1.5	268.0	70.8	1.5	331.0	87.5	2.2	388.8	102.7
0.6	60	20.1	0.75	124.0	32.8	0.75	161.0	42.5	1.5	260.0	68.9	2.2	323.0	85.3	2.2	383.1	101.2
1.0	100	33.5	0.75	118.8	31.4	1.1	156.0	41.2	1.5	255.6	67.5	2.2	315.2	83.3	3.0	379.2	100.2
1.8	180	60.4	1.1	105.0	27.7	1.1	140.0	37.0	1.5	235.0	62.1	2.2	286.1	75.6	3.0	351.3	92.8
2.5	250	83.8	1.1	83.7	22.1	1.5	102.0	26.9	2.2	208.0	55.2	3.0	266.0	70.3	3.0	304.1	80.3

F9B-5600			700 rpm			900 rpm			1400 rpm			1750 rpm			2000 rpm		
Bar	kPa	ft	kW	l/min	GPM	kW	l/min	GPM	kW	l/min	GPM	kW	l/min	GPM	kW	l/min	GPM
0.3	30	10.1	0.75	129.0	34.1	1.1	170.0	44.9	1.5	270.0	71.3	1.5	331.0	87.5	2.2	376.0	99.3
0.6	60	20.1	0.75	126.0	32.8	1.1	165.0	43.6	1.5	266.0	70.3	2.2	323.0	85.3	2.2	368.0	97.2
1.0	100	33.5	0.75	123.0	32.5	1.1	161.1	42.6	2.2	260.0	68.7	2.2	314.0	83.3	3.0	361.0	95.4
1.8	180	60.4	0.75	110.0	29.1	1.5	153.0	40.4	2.2	242.0	63.9	2.2	291.0	76.9	3.0	340.0	89.8
2.5	250	83.8	1.1	90.0	23.8	1.5	130.0	34.3	2.2	218.0	57.6	3.0	269.0	71.1	3.0	312.0	82.4
3.0	300	100.6	1.5	61.0	16.1	2.2	102.0	26.9	3.0	190.0	50.2	3.0	242.0	63.9	3.5	284.0	75.0
3.5	350	117.4	-	-	-	-	-	-	3.0	160.0	42.3	3.5	205.0	54.2	3.5	235.0	62.1

F95B			700 rpm			900 rpm			1400 rpm			1750 rpm			2500 rpm		
Bar	kPa	ft	kW	l/min	GPM	kW	l/min	GPM	kW	l/min	GPM	kW	l/min	GPM	kW	l/min	GPM
0.5	50	16.8	0.75	182.6	48.2	1.1	236.5	62.5	1.5	384.2	101.5	2.2	483.6	127.8	4.0	626.7	165.5
1.0	100	33.5	1.1	172.7	45.6	1.1	231.3	61.1	1.5	372.0	98.3	3.0	472.9	124.9	5.5	617.9	163.2
1.5	150	50.3	1.1	160.1	42.3	1.5	214.5	56.7	2.2	350.4	92.6	3.0	444.1	117.3	5.5	583.8	154.2
2.0	200	67.1	1.1	132.3	35.0	1.5	181.0	47.8	3.0	315.4	83.3	3.5	406.2	107.3	5.5	553.1	146.1
2.5	250	83.8	1.5	79.5	21.0	2.2	137.8	36.4	3.0	267.6	70.7	4.0	361.3	95.5	7.5	506.4	133.8

Engine Cooling – Raw Water Handling

Flexible impeller pumps, F-series, provide an efficient solution to most raw water pumping needs. The primary advantage of a flexible impeller pump is its self-priming ability. As the vanes of the impeller are depressed and rebound, they create their own vacuum drawing fluid into the pump. A dry pump can lift water up to as much as 3 meters. Thus a flexible impeller pump being used for engine cooling needs not be located below the water line or manually primed. An added feature of flexible impeller pumps is that they can pass fairly large solids without clogging or damaging the pump. This reduces the need for filtering the incoming fluid.

For general raw or fresh water applications, the standard long lasting neoprene rubber impeller is used.

A general feature of all flexible impeller pumps is that they cannot be permitted to run dry for more than 30 seconds. Both the impeller and the seals depend upon the water for lubrication and will soon burn out if run dry. Wearing parts are easily replaceable, and service kits are available for all standard models.

DIFFERENT TYPES OF COOLING SYSTEMS

Direct cooling

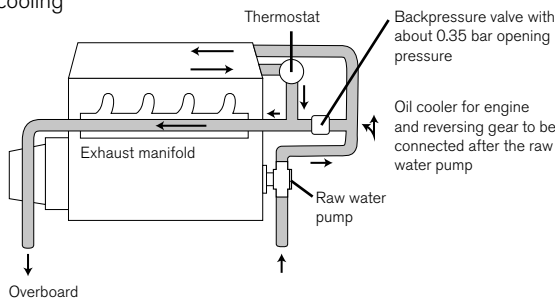

Indirect cooling Inter cooling

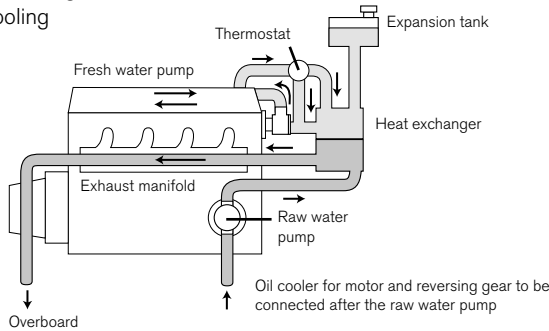

Keel cooling

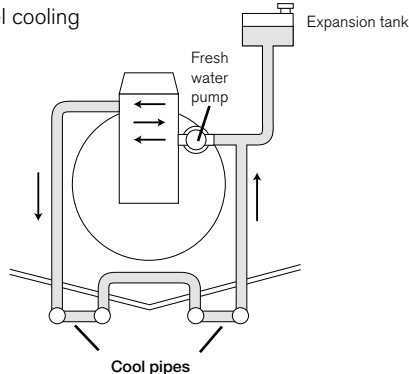

CAPACITY RANGE

(based on water at 20°C/68°F)

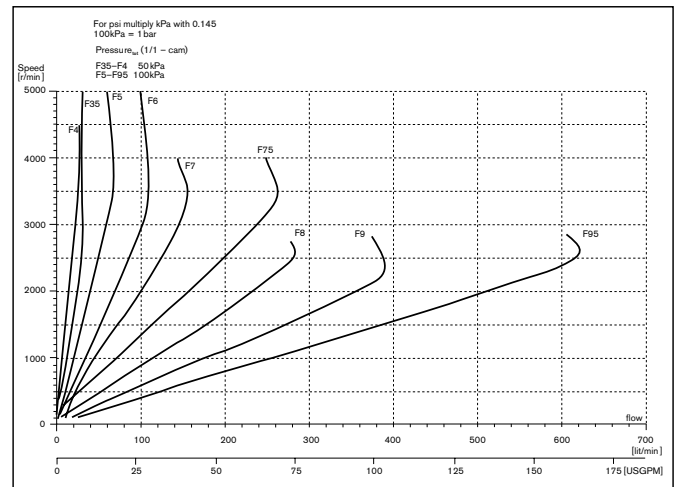

FRESH WATER HANDLING

For circulation of the internal, closed, fresh water circuit of the cooling system SPX Johnson Pump Marine can offer a number of alternatives in its DC driven CM- and C0-series (see page 21 for further information). It is also common to use a flexible impeller pump for this purpose if it is located on the cold side of the system (max. 55°C). Other types of belt-driven centrifugal pumps may also be useful. The closed circuit normally transfers heat from the engine to the heat exchanger. The liquid is water and anti-freeze.

COOLING CAPACITY

The required output of the cooling pump – raw water as well as fresh water handling – is related to

- engine size and type (gasoline or diesel)
- type of cooling system (size of heat exchanger)
- water cooled engine oil, reverse gear, exhaust system

Contact your local dealer for more information, or for indirect cooling systems your supplier of heat exchangers.

PUMP MOUNTING

Engine cooling pumps, the F-series, are available in several different styles and sizes to satisfy different cooling system needs. Flanged pumps which mount directly to the engine and crank shaft pulley mounted pumps are available for a wide variety of engines. SPX Johnson Pump Marine is one of the original equipment pump supplier to the largest manufacturers world-wide of inboard engines. Both flange mounted and pulley driven pedestal pumps can be used to provide cooling with a maximum of ease and flexibility. Pump ports are available in sizes from 3/8" to 2 1/2".

FLANGE MOUNTED PUMPS

Flanged pumps are normal pumps produced in high volumes, customer designed for flange-mounting at a power take off of the engine. Different types of drives can be used but mainly gears or any type of driving members are used.

CRANK SHAFT PULLEY MOUNTED

These pumps are designed for direct installation on the engine crank shaft pulley. Max. revs. 5.000 per minute.

To prevent the pump from rotating, a torque bracket from the fastening point on the pump body to a suitable point on the engine has to be used.

PEDESTAL MOUNTED PUMPS

Pulley driven pedestal mounted pumps are used when a free driving pulley is available on the engine.

Two different types of pedestal mounted pumps are supplied:

FB-8

A range of bronze pumps in compact design. Ideal as cooling water pumps in marine engines. Available in sizes from 3/8" to 1 1/2", all with permanently lubricated double ball bearings and mechanical seal.

FB-3000

A range of extra heavy duty pedestal mounted pumps excellent for cooling purpose in commercial vessels. The design means separate bearing housings with permanently lubricated double ball bearings, mechanical shaft seal for extended service life. Wetted parts as wear plate, cam and endcover are easily replaceable.

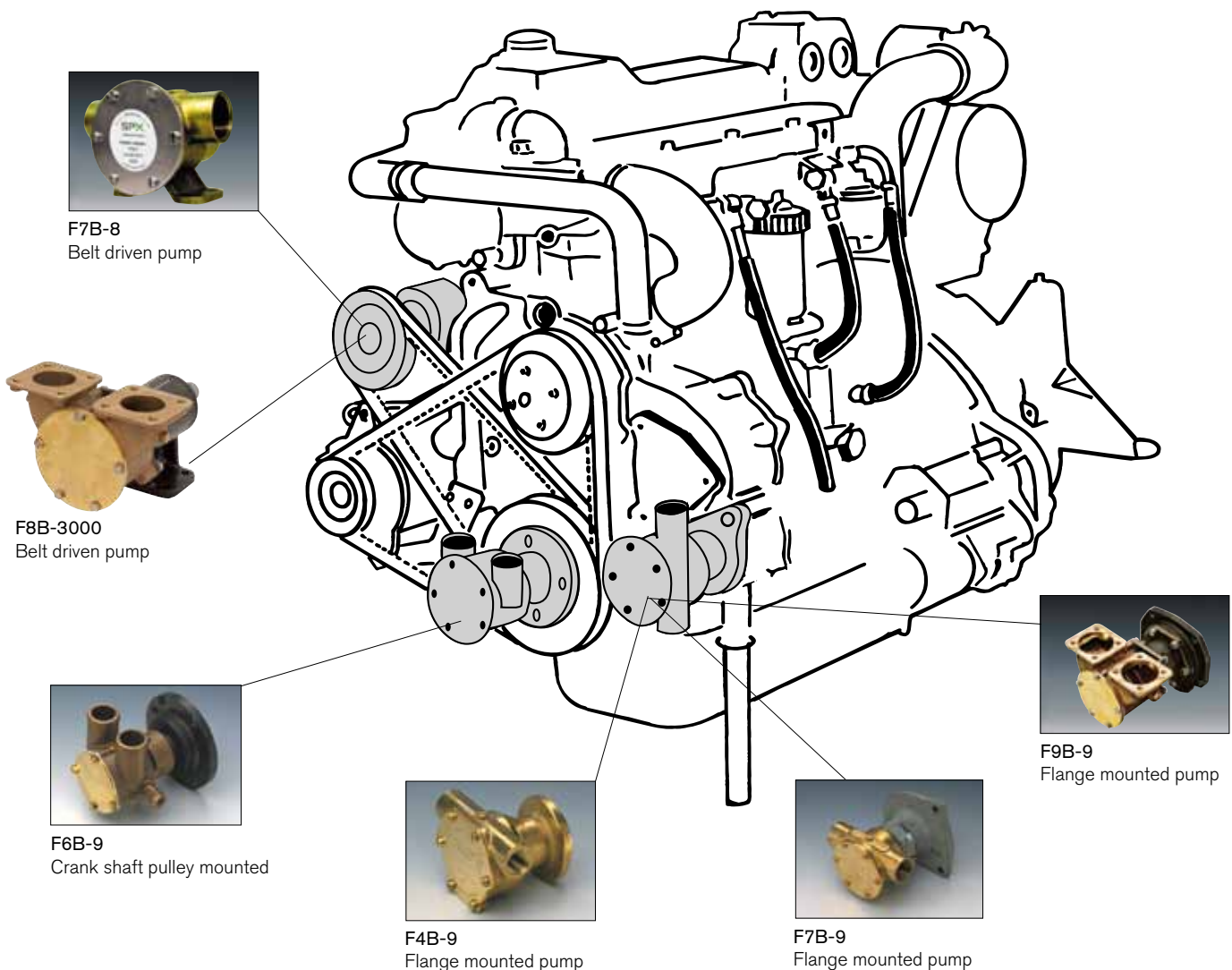

VACUUM VALVE - SIPHON BREAKER

A vacuum valve is a cheap insurance against water intrusion in a engine with expensive repairs as a consequence. The maximum ambient temperature should not exceed 60 °C. The valve opens at a pressure which is equivalent to 3-5 cm Water Column. The materials which are used are resistant to sea water and fresh water, and to glycol compounds in appropriate concentrations. Avoid exposing the valve to oil and grease. If it has been in contact with such substances, please clean or replace it.



Order No.	Description
09-47316-01	Siphon Breaker, Spud Size 12 mm
09-47316-02	Siphon Breaker, Spud Size 16 mm
09-47316-03	Siphon Breaker, Spud Size 19 mm
09-47316-04	Siphon Breaker, Spud Size 22 mm
09-47316-05	Siphon Breaker, Spud Size 25 mm
09-47316-06	Service Kit

- Non corrosive
- Easy to install
- Does not leak
- High quality plastic
- 5 spud sizes

RAW WATER COOLED ENGINE

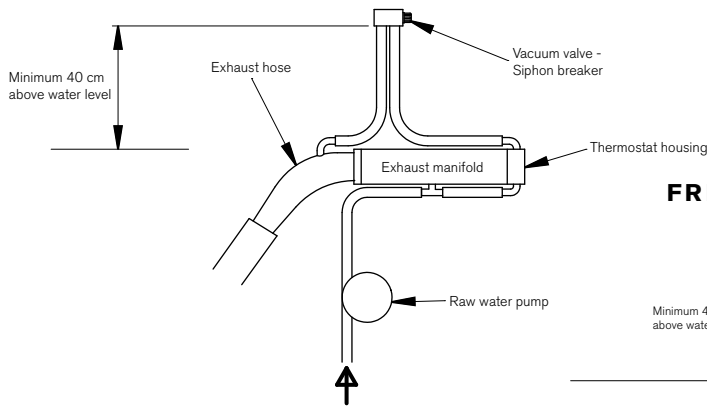

FRESH WATER COOLED ENGINE

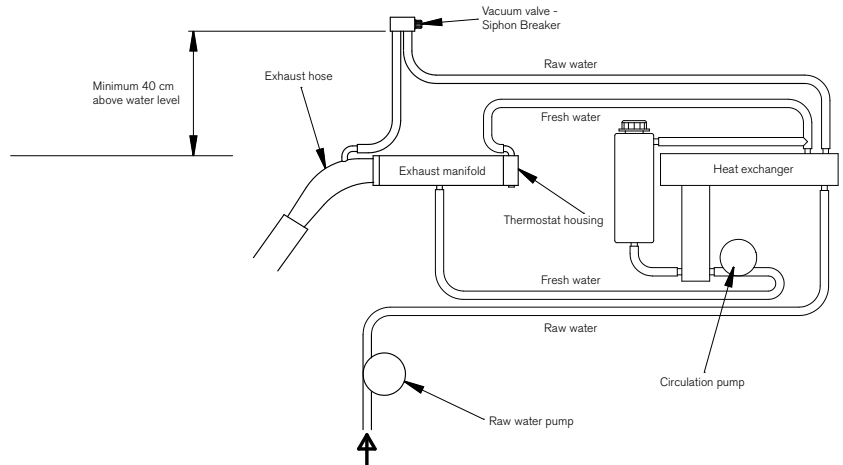

TAKE GOOD CARE OF THE COOLING SYSTEM - CHANGE TO A NEW IMPELLER EVERY YEAR!

The impeller is a very important security device. Its task is to pump the water through the cooling system of the engine. But remember that the impeller should be replaced every year. And always make sure you get a SPX Johnson Pump original impeller. Then you'll know that it matches your pump exactly.

Remove the impeller with a slip joint plier or an Impuller.

Order No.	Description
09-47165-01	Puller for 09-1028BT
09-47163-01	Puller for 09-821BT
09-36166-01	Puller for 09-820B
09-47086	Impeller lubricant display

Order No.	Description
09-950-930	JP Impuller



SPX'S JOHNSON PUMP MARINE BRAND ORIGINAL IMPELLERS KITS

Ref.	Pump	Impeller	Material*	Outer dia		Inner dia		Width		Replaces Jabsco No	
				mm	inch	mm	inch	mm	inch	Europe	USA
1	F2	09-1077B-9	Nitrile	35.2	1.29	8.0 / Flat	0.31 / Flat	12.7	0.50		
2	F3	09-843S-9	Nitrile	45.2	1.78	8.0 / Flat	0.31 / Flat	12.8	0.50		
3	TA3P10	09-1052S-9	Nitrile	45.2	1.78	8.0 / Flat	0.31 / Flat	12.8	0.50		
4	F35	09-806B-1	MC97	40.0	1.58	9.5	0.37	19.0	0.75	4528-0001	
5	F35	09-808B-1	MC97	40.0	1.58	12.0	0.47	19.0	0.75	22405-0001	
6	F4	09-824P-1EZ	Polyurethane	50.8	2.00	8.0 / Flat	0.31 / Flat	22.0	0.87	6303-0007	
6	F4	09-824P-9	Nitrile	50.8	2.00	8.0 / Flat	0.31 / Flat	22.0	0.87	6303-0003	
7	F4	09-810B-1	MC97	50.8	2.00	12.0	0.47	22.0	0.87	18653-001	
7	F4	09-810B-9	Nitrile	50.8	2.00	12.0	0.47	22.0	0.87		
8	F4	09-1026B-1	MC97	50.8	2.00	12.7	0.50	22.0	0.87	673-0001	
8	F4	09-1026B-9	Nitrile	50.8	2.00	12.7	0.50	22.0	0.87	673-0003	
9	F5	09-801B	Neoprene	57.1	2.25	15.9 Key	0.63 / Key	31.5	1.24	4568-0001	
10	F5	09-1027B-1	MC97	57.1	2.25	Splines		31.5	1.24	1210-0001	
10	F5	09-1027B-10	MC97	57.1	2.25	Splines		31.85	1.24		
10	F5	09-1027B-9-00	Nitrile	57.1	2.25	Splines		31.5	1.24	1210-0003	
11	F6	09-812B-1	MC97	57.1	2.25	Splines		48.2	1.90	13554-0001	
12	F7	09-1028BT-1**	MC97	65	2.56	Splines		50.2	1.98	17937-0001	
12	F7	09-1028B-9	Nitrile	65	2.56	Splines		50.2	1.98	17937-0003	
13	F75	09-821BT-1**	MC97	65	2.56	Splines		80	3.15		
14	F8	09-819B-00	Neoprene	95	3.74	Splines		63	2.48	836-0001	17935-0001
14	F8	09-819B-9	Nitrile	95	3.74	Splines		63	2.48	836-0003	17935-0003
15	F8	09-1029B ¹⁾	Neoprene	95	3.74	Splines		63	2.48	836-0001	17935-0001
16	F9	09-802B	Neoprene	95	3.74	Splines		88.5	3.48	6760-0001	
17	F9	09-814B	Neoprene	95	3.74	Splines		88.5	3.48	21676-0001	17936-0001
18	F95	09-820B	Neoprene	95	3.74	Splines		130	5.12		
19	F98	09-842B	Neoprene	95	3.74	Splines		180	7.09		
* MC97 and Neoprene - for cooling, Nitrile - oil resistant				¹⁾ Alternative impeller 09-819B							
** BT-1 replaces B											
A		09-701B-1	MC97	62,3	2,45			31,8	1,25	18838-0001	
B		09-702B-1	MC97	65,4	2,57			41,4	1,63	18948-0001	
C		09-703B-1	MC97	66,7	2,63			51	2,01	17954-0001	
D		09-704BT-1	MC97	84,1	3,31			73,4	2,89	18958-0001	
E		09-705BT-1	MC97	94,5	3,72			101,6	4	-	

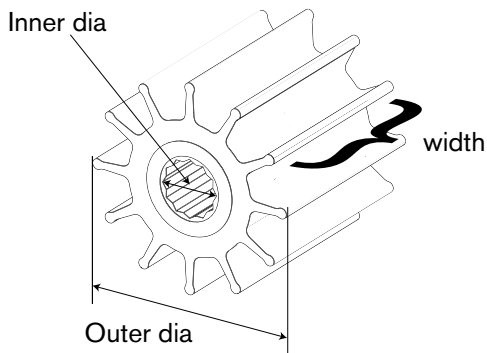

SPX Johnson Pump Original Impellers

SCALE 1:1

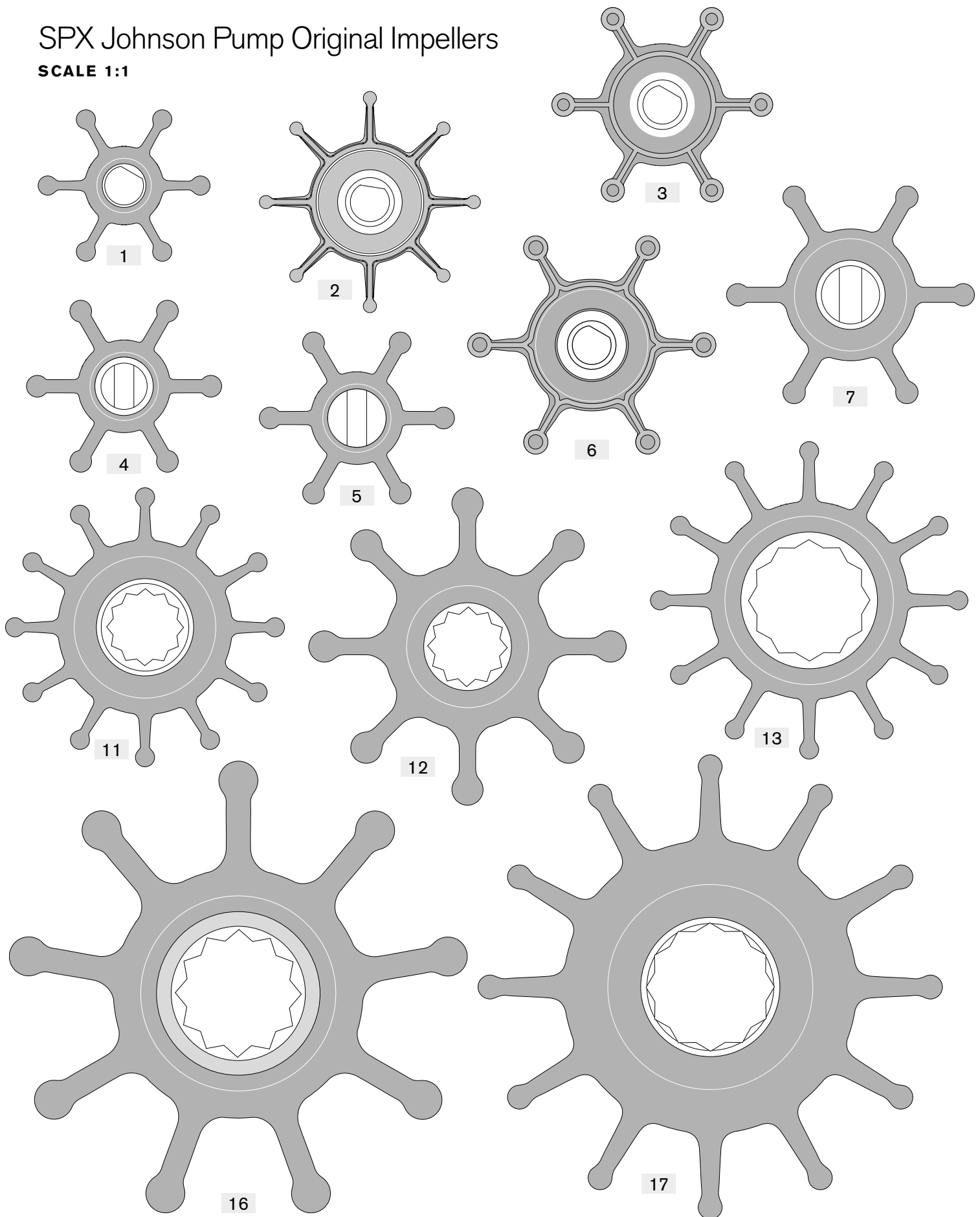

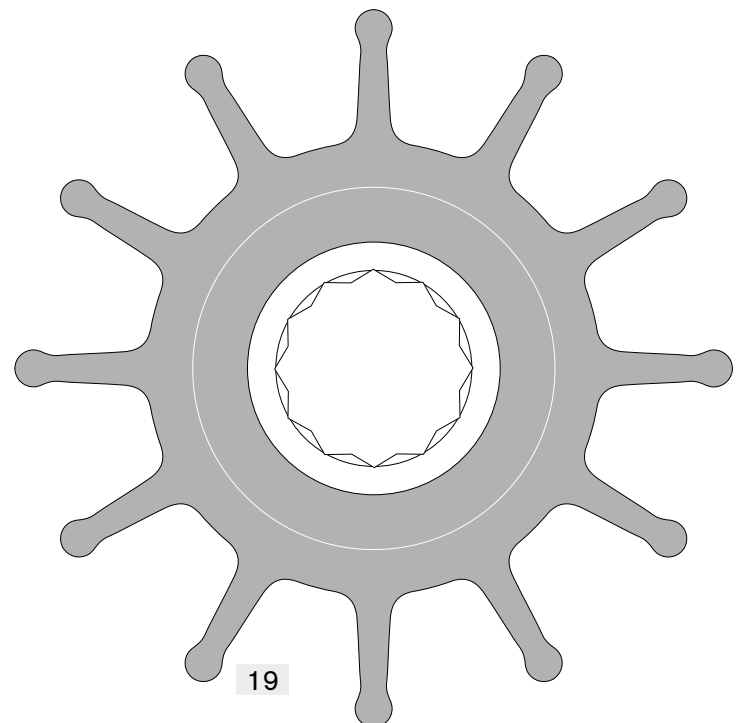
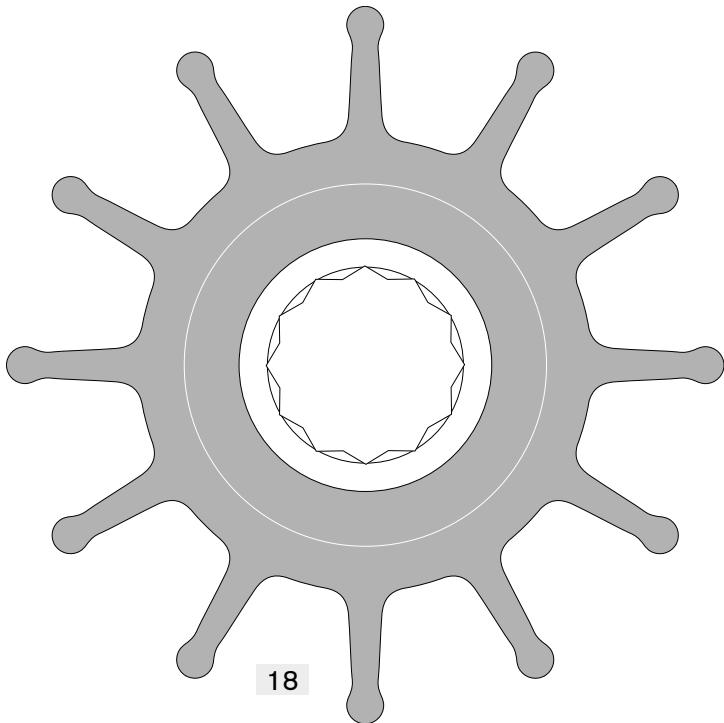
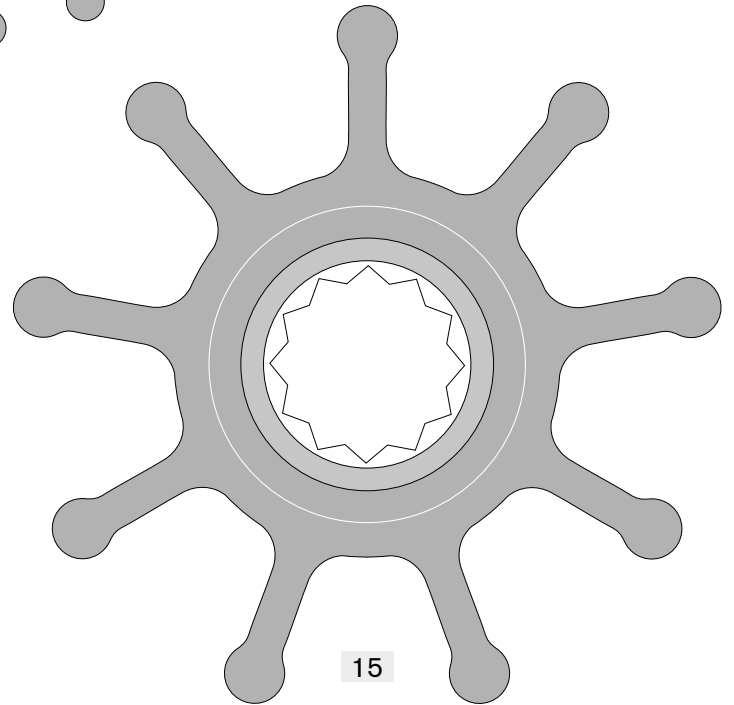
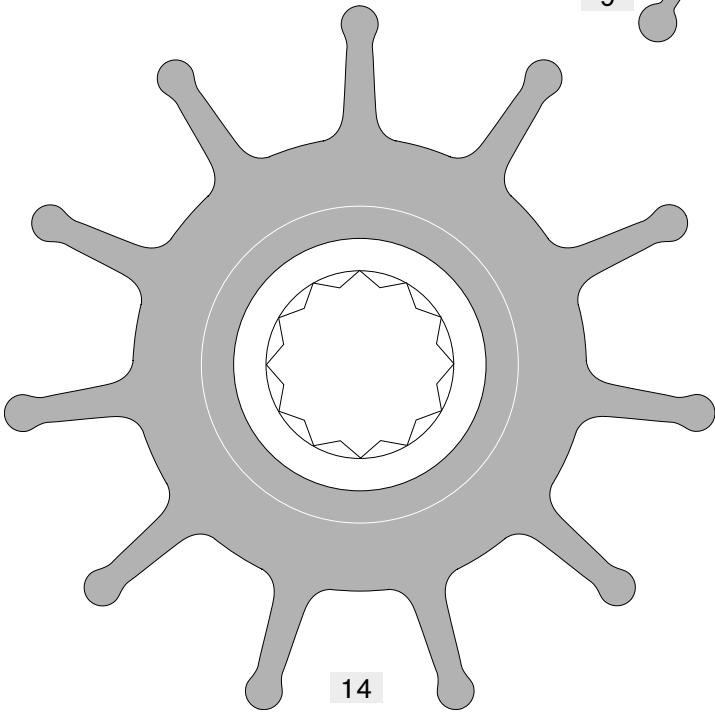
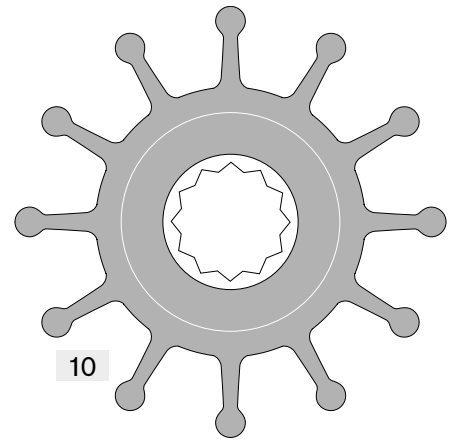
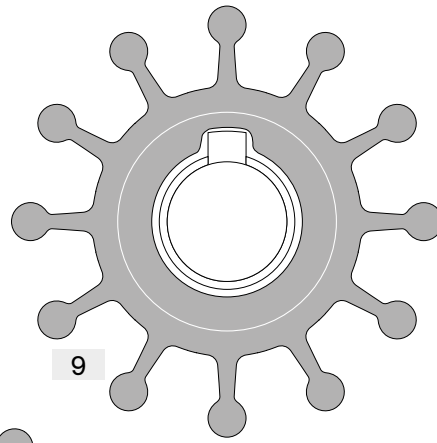
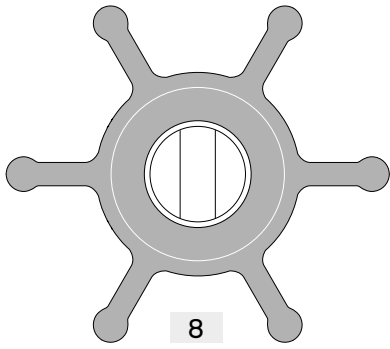

Impeller Replacement Kits

SCALE 1:1

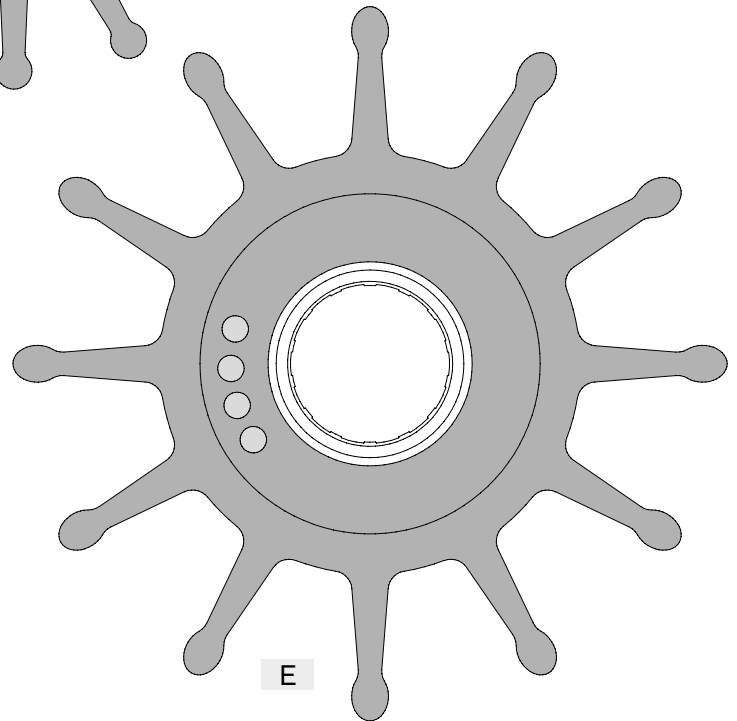
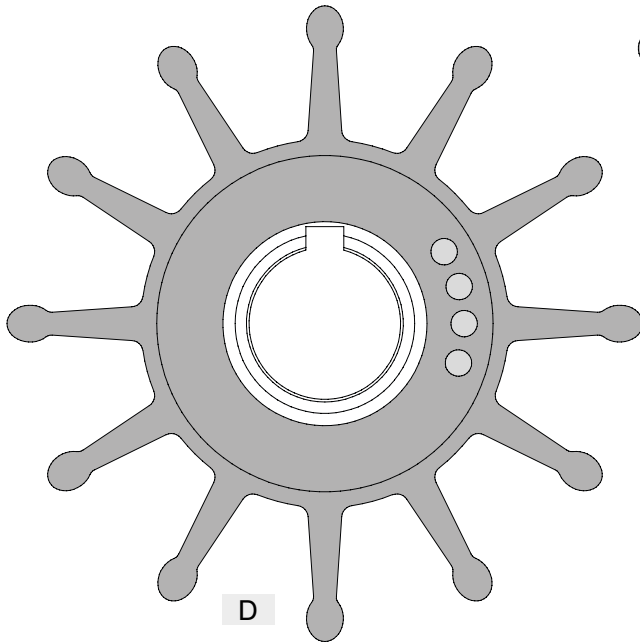
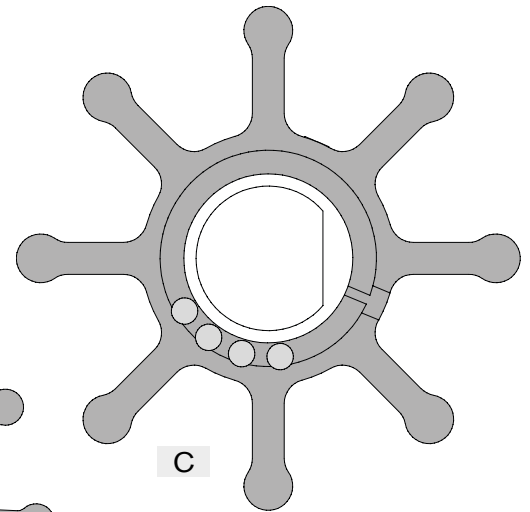
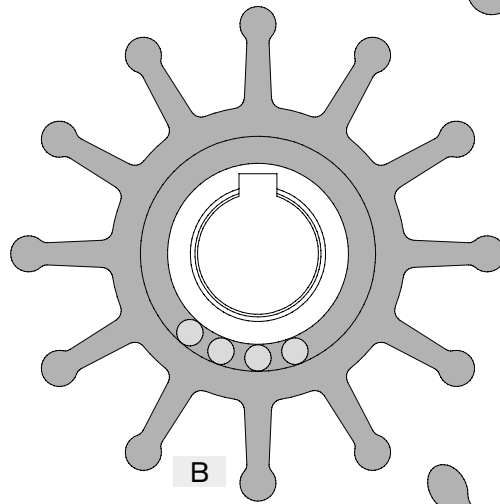
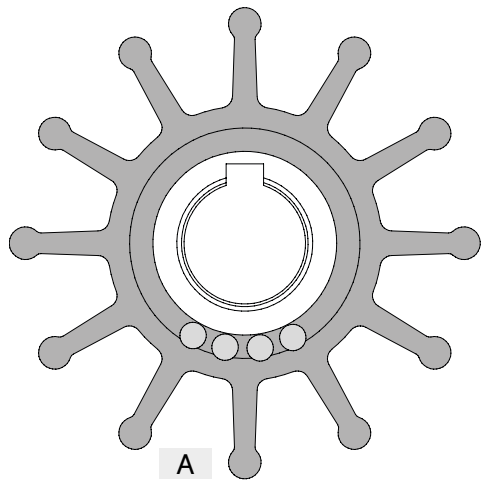

IMPELLER REPLACEMENT KITS

Ref.	SPX Johnson Pump part no.	Sherwood part no.	MerCruiser part no.	Jabsco part no.	Engines / Pumps
A	09-701B-1	9959K	-	18838-0001	Chris Craft; Chrysler Marine; Commander; Crusader; Glastron Boat Co.; Gray Marine; Interceptor; Onan; OMC; Pathfinder VolksWagon Eng.; Perkins Eng. U.S.; Plesurecraft Marine; Universal Medalist; Volvo Penta; Yamaha; Westerbeke 24102; Sherwood 11353; Pleasure Craft 302&351; Chris Craft 350; Onan MDL3,4
B	09-702B-1	10615K	-	18948-0001	Chris Craft; Chrysler Marine; Commander; Crusader; Escort (Skiltec); Gray Marine; Isuzu; Lenco; Marine Power; North American Engine; Onan; Osco Motors; OMC; Perkins Engine U.S.; Plesurecraft Marine; Volvo Penta; J.H. Westerbeke Corp; Crusader 97179; Chrysler 3675763; Chrysler 4142878; Cummins 4B; Onan MDL6; Chris Craft 454; Pleasure Craft 454
C	09-703B-1	-	47-59362T	17954-0001	Pump Quicksilver Model 46-72774 A32
D	09-704BT-1	17000K	-	18958-0001	Cummins 6B 300Hp B Series; Cummins C Series; CAT 3208; CAT 3116; CAT 3126; Deere 6076; Sherwood Pump P17 series
E	09-705BT-1	18000K	-	-	Sherwood Pump P18 Series
F	09-1028BT-1	18200K	-	17933-0001	



TECH TOOLS

SMART BATTERY CHARGER

The 3176 utilizes a 5-stage automatic 5 amp charging system to quickly and efficiently charge a 12V battery while also extending its life. The automatic power switch feature will give the technician complete confidence that they are not damaging the battery by automatically switching to float mode once the battery is completely charged. This switching technology also helps to restore batteries that are slightly sulfated.

Order No.	Description
3176	Smart Battery Charger



BATTERY LOAD TESTERS

Applying a powerful 130 amp load, this heavy-duty battery tester delivers more accurate results than conventional 100 amp testers. Use it to determine a battery's state of charge as well as cranking and charging volts. With full 100-amp load-testing capacity, this reliable and highly accurate tester works on both 6- and 12-volt batteries. The unit performs both a voltage test and 15-second battery-load testing. Results are displayed on a color-coded 0-16 volt scale.

Order No.	Description
CP7614	130 AMP Battery Load Tester
CP7612	100 AMP Battery Load Tester



BATTERY ALTERNATOR TESTER

This versatile charging system (battery and alternator) tester requires no internal battery of its own and is compact for maximum convenience.

Order No.	Description
CP7611	Battery Alternator Tester



MINI CIRCUIT TESTER

This compact, ergonomically designed coil cord circuit tester helps to quickly locate hot circuits. The cord is constructed from high quality, high visibility polyurethane for superior memory retention and resistance to oil and grease and is ideal for benchtop work and in small areas.

Order No.	Description
CP7841	Mini Circuit Tester



AC/DC CIRCUIT TESTER

Tests spark plug wires, 12V car/truck batteries, 4-13V variable DC voltage, household 110/220 AC, DC wire/circuit.

Order No.	Description
CP7847	AC-DC Circuit Tester



IR THERMOMETER

Infrared thermometers do everything from verifying the temperature in your AC system in the car or home to helping electricians to find an overcharge in electrical systems. Recent advances in optics make this technology more accurate and cost-effective.

Order No.	Description
CP7876	IR Thermometer Pro

Index

Art.No	Page	Art.No	Page	Art.No	Page	Art.No	Page
0.3454.001	46	09-46551	29	10-13373-03	33, 38	10-24569-01	44
0.3454.002	46	09-46553	27	10-13373-04	33, 38	10-24569-51	44
0.3454.003	46	09-46557-01	45	10-13373-07	33	10-24570-01	44
0.3454.004	46	09-46780	8	10-13373-08	33	10-24570-51	44
0.3454.050	46	09-46781-01	7	10-13395-103	6	10-24571-01	44
0.3454.051	46	09-46781-03	7	10-13395-104	6	10-24571-51	44
01-24814	19	09-46839-01	10	10-13399-03	9	10-24572-01	44
01-24815	19	09-46839-02	10	10-13399-04	9	10-24577-98	46
01-36012 PO2	8, 10	09-46938	10	10-13399-0311	8	10-24604-103	6
01-36035	32	09-46939	10	10-13405-103	6	10-24604-104	6
01-36051	33	09-46956	8	10-13405-104	6	10-24664-09	30
01-36099-1	8	09-46957	10	10-13406-103	6	10-24664-10	30
01-36192	32	09-46958	10	10-13406-104	6	10-24677-01	38
09-701B-1	52, 55	09-47086	9	10-13406-107	6	10-24677-02	38
09-702B-1	52, 55	09-47087	10	10-13406-108	6	10-24677-03	23
09-703B-1	52, 55	09-47088	10	10-13407-07	9	10-24689-03	26
09-703P-1	52	09-47089	10	10-13407-08	9	10-24689-04	26
09-704BT-1	52, 55	09-47092	10	10-13408-01	7	10-24690-03EZ	26
09-705BT-1	52, 55	09-47094	10	10-13408-02	7	10-24690-04EZ	26
09-801B	52	09-47098	10	10-13408-03	7	10-24727-03	26
09-802B	45, 46, 52	09-47148	32	10-13408-04	7	10-24727-04	26
09-806B-1	52	09-47149	32	10-13409-01	7	10-24728-03	9
09-808B-1	44, 47, 52	09-47163-01	51	10-13409-02	7	10-24728-04	9
09-810B-1	44, 52	09-47165-01	51	10-13410-01	7	10-24750-09	30
09-810B-9	44, 52	09-47196	26, 27	10-13410-02	7	10-24750-10	30
09-812B-1	47, 52	09-47316-01	38, 51	10-13411-01	7	10-24753-01	47
09-814B	45, 46, 52	09-47316-02	38, 51	10-13411-02	7	10-24760-03	26
09-819B-00	45, 52	09-47316-03	38, 51	10-13530-01	18	10-24760-04	26
09-819B-9	44, 45, 52	09-47316-04	38, 51	10-22020-101	8	10-24800-01	17
09-820B	45, 46, 51, 52	09-47316-05	38, 51	10-24116-98	46	10-24800-10	17
09-821BT-1	52	09-47316-06	38, 51	10-24116-99	46	10-24800-11	17
09-824P-1	26, 52	09-60616	9	10-24180-2	26	10-24800-12	17
09-824P-1EZ	26, 52	09-CD65582	8	10-24188-4	27	10-24886-02	26
09-824P-9	26, 52	10-13021-1	44	10-24188-5	27	10-24898-01	30
09-842B	52	10-13021-9	44	10-24190-1	29	10-24898-02	30
09-843S-9	26, 52	10-13021-95	44	10-24190-2	29	10-24901-01	30
09-950-930	51	10-13021-96	44	10-24209-7	45	10-24901-02	30
09-1026B-1	52	10-13022-95	46	10-24210-5	45	10-24915-01	47
09-1026B-9	52	10-13022-96	46	10-24228-1	47	10-35038-5	47
09-1027B-1	44, 45, 52	10-13022-98	46	10-24389-02	47	10-35038-5E	47
09-1027B-9	27, 44, 45, 52	10-13024-1	45	10-24398-01	47	32-47258-003	15
09-1027B-9-00	45, 52	10-13025-99	46	10-24428-01	47	32-47259-003	15
09-1027B-10	47, 52	10-13026-7	45	10-24453-01	34	32-47260-003	15
09-1028B-9	44, 45, 52	10-13027-99	46	10-24453-02	34	32-47261-002	15
09-1028BT-1	44, 45, 47, 52, 55	10-13121-04	45	10-24486-03	29	36-503-023	29
09-1029B	52	10-13143-99	46	10-24486-04	29	56-47455-01	41, 42
09-1052S-9	52	10-13175-01	45	10-24487-03	29	56-47455-01/02	41, 42
09-1077B-9	26, 52	10-13176-99	46	10-24487-04	29	56-47455-02	41
09-10616	8	10-13177-01	45	10-24488-03	29	56-47455-03	41, 42
09-13384	32	10-13178-99	46	10-24488-04	29	56-47455-03/04	41, 42
09-24652-02-CN	10	10-13225-01	45	10-24489-03	29	56-47455-04	41
09-24652-04-CN	10	10-13226-98	46	10-24489-04	29	56-47456-01	41, 42
09-24653-02-CN	8, 10	10-13226-99	46	10-24501-03	29	56-47456-01/02	41, 42
09-24653-03-CN	10	10-13252-103-BW	23	10-24501-04	29	56-47456-02	41
09-24792	19	10-13252-107-BW	23	10-24502-03	29	56-47456-03	41, 42
09-24794	19	10-13281-05	7	10-24502-04	29	56-47456-03/04	41, 42
09-24818	19	10-13281-06	7	10-24503-03	29	56-47456-04	41
09-36166-01	51	10-13329-103	7	10-24503-04	29	56-47457-01	41, 42
09-36250	18	10-13329-104	7	10-24504-03	29	56-47457-01/02	41, 42
09-45053	27, 45	10-13350-03	32	10-24504-04	29	56-47457-02	41
09-45562	45	10-13350-03-003	32	10-24516-03	26	56-47457-03	41, 42
09-45595	34	10-13350-04	32	10-24516-04	26	56-47457-03/04	41, 42

Art.No	Page	Art.No	Page	Art.No	Page	Art.No	Page
56-47457-04	41	81-47245-06	38	32703	14	65000	27
56-47458-01	41, 42	81-47246-01	38	32903	14	66302	40
56-47458-01/02	41, 42	81-47246-02	38	32903-24 V	14	66402	40
56-47458-02	41	81-47246-03	38	33103	14	69103	8
56-47458-03	41, 42	81-47247-01	38	33703	14	70195	24
56-47458-03/04	41, 42	81-47248-01	38	34024	23	71245	24
56-47458-04	41	81-47248-02	38	36152	14, 20	72303	20
56-47459-01	41, 42	81-47267-01	38	36252	20	72303-001	20
56-47459-01/02	41, 42	81-47268-01	38	36303	16, 20	72303-002	20
56-47459-02	41	81-47269-01	38	38103	22	74105	24
56-47459-03	41, 42	81-47273-01	38	38123	22	75035-00	24
56-47459-03/04	41, 42	81-47274-01	38	38503	22	75095	24
56-47459-04	41	81-47301-01	38	38703	22	75125	24
56-47464-01	41	81-47301-02	38	40004	13	77125	24
56-47464-02	41	81-47520-01	38	40057	11	82004	19
70-50005	18	06203-00	15	40084	13	82004-24 V	19
70-50007	18	01604-00	13	42123	14	82024	8
70-50025	18	01604-002	13	42123-24	14	82044	19
70-50027	18	01674-001	13	48103	22	82044-24 V	19
80-47229-01	35, 36	01674-002	13	48503	22	82054	22
80-47229-01 1	35	02204-00	13	48703	22	90061	24
80-47230-01	35, 36	02204-002	13	48903	22	90191	24
80-47231-01	35, 36	02274-00	13	50102	13, 16	90191-00	24
80-47231-02	35, 36	3176	56	50511	13, 16	90261	24
80-47232-01	35, 36	05503-00	15	50533	14, 16	90331	24
80-47232-02	35, 36	05703-00	15	50581	13	90511	24
80-47416-01	40	05903-00	15	51122	13	90681	24
80-47416-02	40	07503-00	15	51123	14	90681-00	24
80-47417-01	40	07703-00	15	51124	14	90791	24
80-47417-02	40	07903-00	15	54033	22	92105	14, 16
80-47418-01	40	07903-24	15	54061-22	13, 16, 22	92205	14, 16
80-47418-02	40	08203-00	15	54061-23	13, 16, 22	200600032	11
80-47419-02	40	08203-24	15	54061-24	13	CP7611	56
80-47420-01	40	10605-00	20	54124	40	CP7612	56
80-47420-02	40	10615-00	8	54154	40	CP7614	56
80-47421-01	40	16004-00	13, 23	54239	20	CP7841	56
80-47421-02	40	16004B	22	54264	13	CP7847	56
80-47422-02	40	16004B-24	22	54274	13	CP7876	56
80-47435-01	35, 37	16084-00	13, 23	54304	16		
80-47435-02	35, 37	20195	19	57151	16		
80-47436-01	35, 37	20255	19	57151-24	16		
80-47436-02	35, 37	20375	19	58001-00	11		
80-47508-01	27	21405	16	58003	11		
80-47508-02	27	21405HP	16	58004-00	11		
81-36105-01	38	22004	13	58005-00	11		
81-47237-01	38	22084	13	58008	11		
81-47237-02	38	22102	15	60000	23		
81-47237-03	38	22502	15	61104-00	8		
81-47238-01	38	22702	15	61115	8		
81-47239-01	38	022741-002	13	61121	11		
81-47240-01	38	24052	23	61122	11		
81-47240-02	38	26014	20	61123	8		
81-47241-01	38	28103-00	22	61124	8		
81-47241-02	38	28123	22	61125	22		
81-47242-01	38	28503	22	61127A	11		
81-47243-01	38	28512	16, 19	61155	8		
81-47244-01	38	28512-24V	16	64534	8		
81-47245-01	38	28512/42522	19	64534-24	8		
81-47245-02	38	28552	19	64534CL	8		
81-47245-03	38	28572	19	64535	8		
81-47245-04	38	28703	22	64634	22		
81-47245-05	38	32503	14	64736-00	9		



Your local contact:

SPX Flow Technology
Nastagatan 19, P.O. Box 1436, SE-701 14 Örebro, Sweden. *
1625 Hunter Road, Suite B, Hanover Park, Illinois, 60133, USA
300 Wellington Rd, Mulgrave, Victoria 3170, Australia

For more information about our worldwide locations, approvals, certifications, and local representatives, please visit www.spx.com and www.johnson-pump.com/jpmarine.

SPX Corporation reserves the right to incorporate our latest design and material changes without notice or obligation. Design features, materials of construction and dimensional data, as described in this bulletin, are provided for your information only and should not be relied upon unless confirmed in writing.

Issued: JPM-01-US Version: 01/2016 Issued: 09/2015

Copyright © 2015 SPX Corporation



* Site Örebro, Sweden