

# USER'S MANUAL

## MONOBLOCK POWER AMPLIFIERS

PM2500 | PM1500

## 2-CHANNEL BRIDGEABLE POWER AMPLIFIERS

PT3000 | PT2200 | PT1600 | PT1000

## 4-CHANNEL BRIDGEABLE POWER AMPLIFIERS

PF2600 | PF2200 | PF1800

## 5-CHANNEL BRIDGEABLE POWER AMPLIFIERS

PV3700



BOSS Audio Systems

3451 Lunar Court • Oxnard, CA 93030

[www.bossaudio.com](http://www.bossaudio.com) | 805.751.4853

tech support: [www.bossaudio.com/technical-support](http://www.bossaudio.com/technical-support)



0115

# USER'S MANUAL

## MONOBLOCK POWER AMPLIFIERS

PM2500 | PM1500

## 2-CHANNEL BRIDGEABLE POWER AMPLIFIERS

PT3000 | PT2200 | PT1600 | PT1000

## 4-CHANNEL BRIDGEABLE POWER AMPLIFIERS

PF2600 | PF2200 | PF1800

## 5-CHANNEL BRIDGEABLE POWER AMPLIFIERS

PV3700





**PT1000**  
**PT1600**  
**PT2200**  
**PT3000**

*Two Channel  
 MOSFET Car Audio  
 Amplifiers*

**PF1800**  
**PF2200**  
**PF2600**

*Four Channel  
 MOSFET Car Audio  
 Amplifiers*

**PV3700**

*Five Channel  
 MOSFET Car Audio  
 Amplifier*

**PM1500**  
**PM2500**

*MonoBlock  
 MOSFET Car Audio  
 Amplifiers*

**Congratulations on your  
 purchase of a   
 PHANTOM Amplifier.**

It has been designed, engineered and manufactured to bring you the highest level of performance and quality, and will afford you years of listening pleasure.

Thank you for making   
 your choice for car audio  
 entertainment!

**USER'S MANUAL**

page	CONTENTS
<b>2</b>	<b>Introduction</b>
<b>2</b>	<b>What is included?</b>
<b>3</b>	<b>Features</b>
<b>3</b>	<b>About 2 Ohm operation</b>
<b>4</b>	<b>General precautions</b>
<b>4</b>	<b>Installation precautions</b>
<b>4</b>	<b>Mounting the amplifier</b>
<b>5</b>	<b>Connecting the amplifier</b>
<b>6</b>	<b>Low level input wiring</b>
<b>9</b>	<b>High level input wiring</b>
<b>10</b>	<b>2CH Power and Speaker wiring 2CH and Bridged Modes</b>
<b>11</b>	<b>2CH Power and Speaker wiring TriMode</b>
<b>12</b>	<b>4CH Power and Speaker wiring 4CH and Bridged Modes</b>
<b>13</b>	<b>4CH Power and Speaker wiring TriMode</b>
<b>14</b>	<b>5CH Power and Speaker wiring 5CH and Bridged Modes</b>
<b>15</b>	<b>5CH Power and Speaker wiring TriMode</b>
<b>16</b>	<b>MonoBlock Power and Speaker wiring</b>
<b>17</b>	<b>Troubleshooting</b>
<b>18</b>	<b>Specifications</b>

## Introduction

With the **BOSS** PHANTOM MOSFET amplifier series, we are introducing eleven new amplifiers, all designed in the USA. This new series includes a two monoblock amps, six 2-channel, and four 4-channel amplifiers.

All PHANTOM models feature variable low pass and high pass crossovers and variable input gain controls. They also incorporate an input voltage sensitivity selector for added system flexibility.

For further flexibility in the use of a subwoofer, 0-+18dB Bass Boost control has been included on all amplifiers. You can control the subwoofer level with the remote level control module.

**BOSS** AUDIO SYSTEMS understands that amplifiers are placed in many different kinds of installations, so we incorporated a very flexible system of controls in these amplifiers in order to help you integrate the amp into your system regardless of the nature of your input source.

## What is included?

When first unpacking your new amplifier, please check first that the package contains all of the items below. If something is missing, contact the store where you purchased the amplifier.

- **PHANTOM amplifier**
- **Remote subwoofer level control**
- **High input cable with connector**
- **Four (4) mounting screws**

## Features

Your new PHANTOM amplifier features the following:

- **Class A-B operation**
- **Bridgeable outputs**  
(except PM1500 , PM2500 )
- **Tri-Mode capable**  
(except PM1500 , PM2500 )
- **MOSFET PWM (Pulse Width Modulated) Power Supply**
- **2 Ohm stable stereo operation with output power increase**
- **Thermal and speaker short protection**
- **Soft turn-on circuit**
- **Remote turn-on/turn-off circuit**
- **Variable input gain control**
- **Variable low pass crossover(s)**
- **Variable high pass crossover(s)**  
(except PM1500 , PM2500 )
- **Variable 0 to +18dB Bass Boost**
- **Gold-plated RCA low level and high level inputs**
- **LED power and protection indicators**
- **Black anodized heatsink**
- **Remote subwoofer level control**

## About 2 Ohm operation

Your PHANTOM amplifier has been designed to operate efficiently at loads down to 2 Ohms. This means that you can install four 8 Ohm speakers per channel, *when using parallel wiring.*

Increasing the number of woofers per channel at low frequencies (below 100Hz) produces an acoustic coupling effect. This acoustic coupling effect increases your power output by about 3dB per speaker, or the equivalent of an additional 10W per speaker.

When operating at 2 Ohms, the amplifiers will increase their output power by approximately 50%. *The current draw will also increase by about the same amount, so be sure you have enough current to run the amplifiers into a 2 Ohm load.*

If you lack adequate current, your music reproduction will be distorted.

## General precautions

*Before installing and using your new **BOSS** amplifier, please become familiar with all the information contained in this manual.*

*Please keep this manual in a safe place for future reference.*

- Do not open or attempt to repair this unit yourself. Dangerous high voltages are present which may result in electric shock. Refer any repairs to a qualified service technician.
- To avoid risk of electronic shock or damage to the amplifier, do not permit any of this equipment to become damp or wet from water or drinks. If this does occur, immediately unplug the power wires and send the amplifier to your local dealer or service center as soon as possible.
- If there is smoke or any peculiar odor present during use or if there is damage to any of the component enclosures, immediately unplug the power wire and send the amplifier to your local dealer or service center as soon as possible .

## Installation precautions

Before you drill or cut any holes, investigate your car's layout very carefully. Take special care when you work near the gas tank, fuel lines, hydraulic lines and electrical wiring.

Never operate the amplifier when it is unmounted. Attach all audio system components securely to prevent damage, especially in an accident.

Before making or breaking power connections in your system, disconnect the vehicle battery. Confirm that your head unit or other equipment is turned off while connecting the input jacks and speaker terminals.

If you need to replace the power fuse, replace it only with a fuse identical to that supplied with the amplifier. Using a fuse of a different type or rating may result in damage to your audio system or your amplifier which is not covered by the manufacturer's warranty.

## Mounting the amplifier

1. Find a suitable location in the vehicle in which to mount the amplifier.
2. Make sure there is sufficient air circulation around the intended mounting location.
3. Mark the location for the mounting hole screws by positioning the amplifier where you wish to install it. Use a scribe or mounting screw, inserted through each of the amp's mounting holes, to mark the mounting surface. If the mounting surface is carpeted, measure the hole centers and mark with a felt tip pen.
4. Drill pilot holes in the mounting surface for the mounting screws. Place the amplifier in position, and attach the amplifier to the mounting surface securely using screws.

**SHOCK HAZARD! Do not open the case of this product.** There are dangerous voltages present within the unit. There are no user-serviceable parts within the unit.

## Connecting the amplifier

Before doing any wiring, look through this manual and identify the diagrams to follow for power, input and speaker connections for your particular installation. Be sure you understand all the connections before you proceed.

1. Connect the power ground terminal to the closest point on the chassis of the car. Keep this ground wire to less than 39" (100 cm) in length. Use 8 gauge (or heavier) wire.

2. Connect the remote terminal to the remote output of the head unit using 16 gauge (or heavier) wire.

3. Connect an empty fuse holder within 18" (45 cm) of the car battery, and run 8 gauge (or heavier) cable from this fuse to the amplifier location.

4. Check that the fuse holder is empty. Then connect the fuse holder to the "BATT+" connection on the amplifier.

5. If multiple amplifiers are being used in your system, either:

- Run a separate pair of cables from the battery and a chassis ground point to each amplifier. Each (+) cable must have its own inline fuse.

-or-

- Run a #4 cable from the fuse holder at the battery to a distribution block at or near the amplifier's location. Then run separate cables from the amplifier to this distribution block and to independent chassis ground points.

6. Connect all line inputs and outputs (if used) using high-quality cables. Connect all speakers, following the diagrams in this manual. Be sure to observe proper polarity to avoid audio phase problems.

7. Insert fuse(s) into the battery fuse holder(s).

8. Recheck all connections before powering up the amplifier.

9. Set all level controls to minimum position, and set all crossover controls/switches to the desired frequency points.

10. Power up the head unit and the amplifier. Then set the volume control on the head unit to about 3/4 volume, and adjust the amplifier's input level control(s) to just below the level of distortion.

11. Further fine tuning of the various controls may be necessary to obtain best results.

### **Don't misuse the level control!**

Do not mistake the input level control for a volume control! It is designed ONLY to match the output level of your audio source to the input level of your amplifier.

Do not adjust this input level to maximum unless your input level requires it.

Ignoring these instructions will result in an input overload to the amplifier, and excessive audio distortion. It can also cause the protection circuit to engage.

## Low Level Input Wiring

Low-level (RCA) input wiring is preferred for best audio performance. Always use a high-quality RCA cable for best audio performance.

**NOTE: Do not connect BOTH the high level and low level inputs from your receiver to your amplifier at the same time!**

## 2-Channel Amplifiers

PT1000,PT1600,PT2200,PT3000

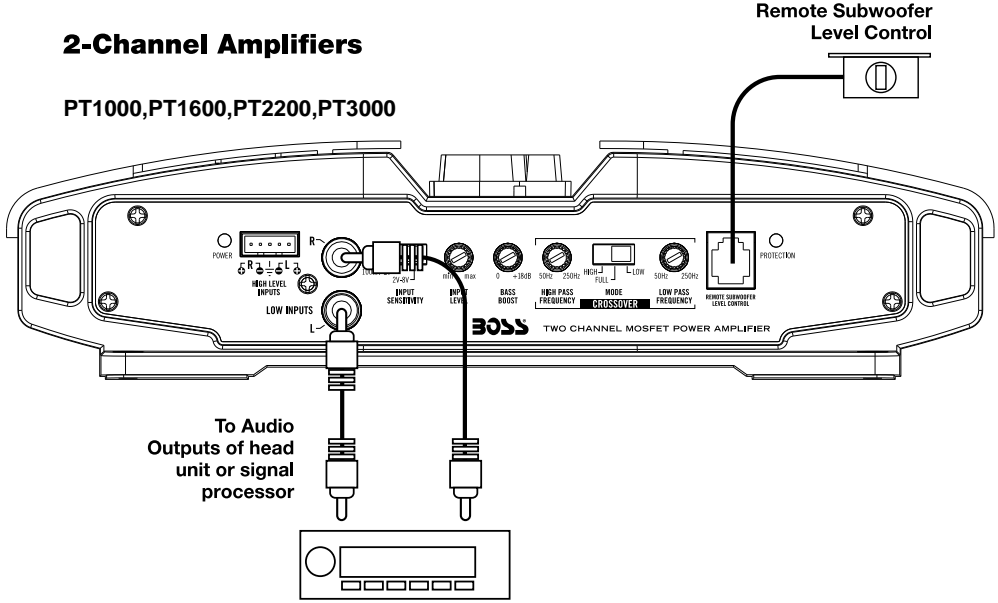

## 4-Channel Amplifiers

PF1800,PF2200,PF2600

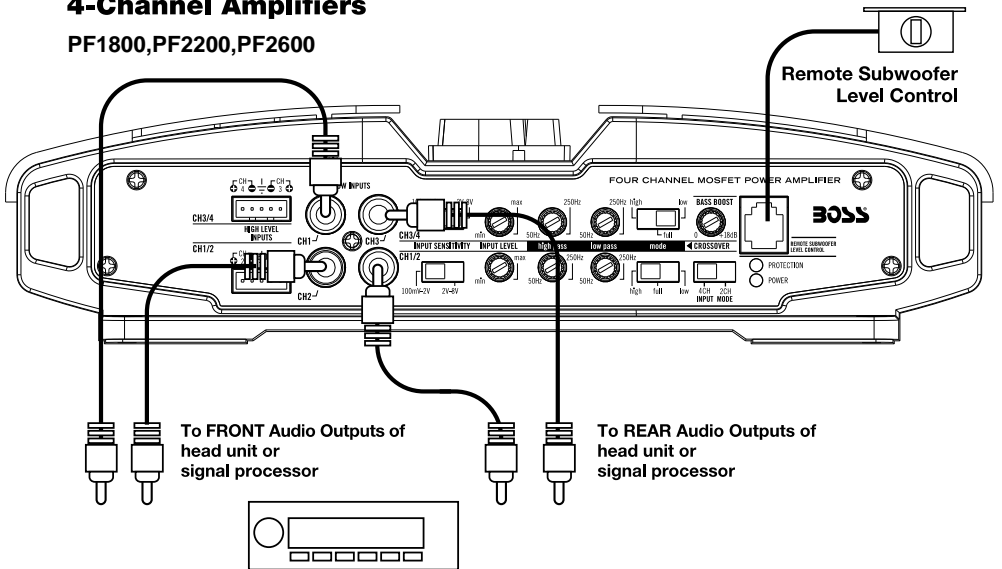

## Low Level Input Wiring

Low-level (RCA) input wiring is preferred for best audio performance. Always use a high-quality RCA cable for best audio performance.

**NOTE: Do not connect BOTH the high level and low level inputs from your receiver to your amplifier at the same time!**

## 5-Channel Amplifier

PV3700

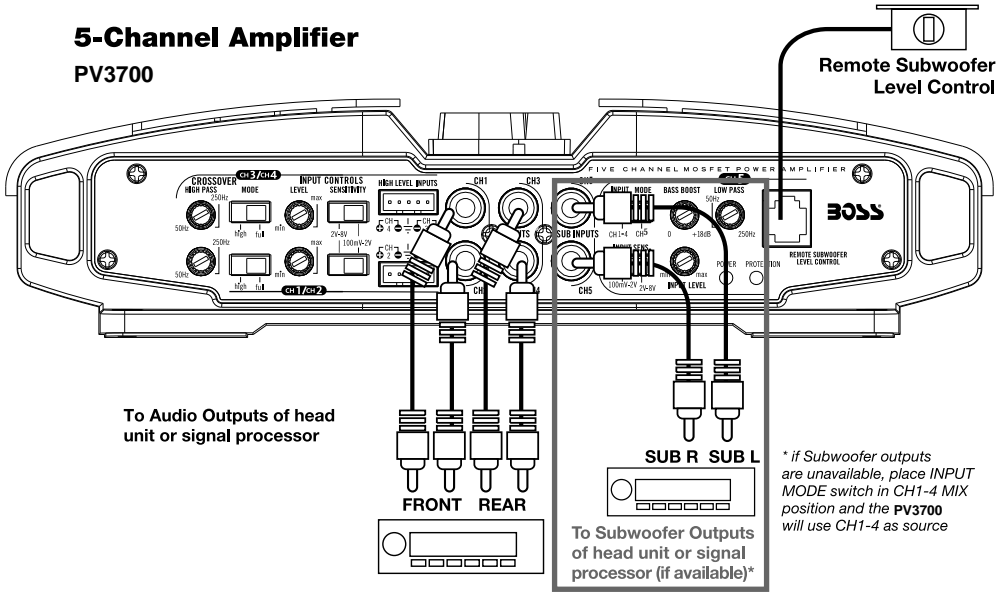

\* If Subwoofer outputs are unavailable, place INPUT MODE switch in CH1-4 MIX position and the PV3700 will use CH1-4 as source

## MonoBlock Amplifier

PM1500, PM2500

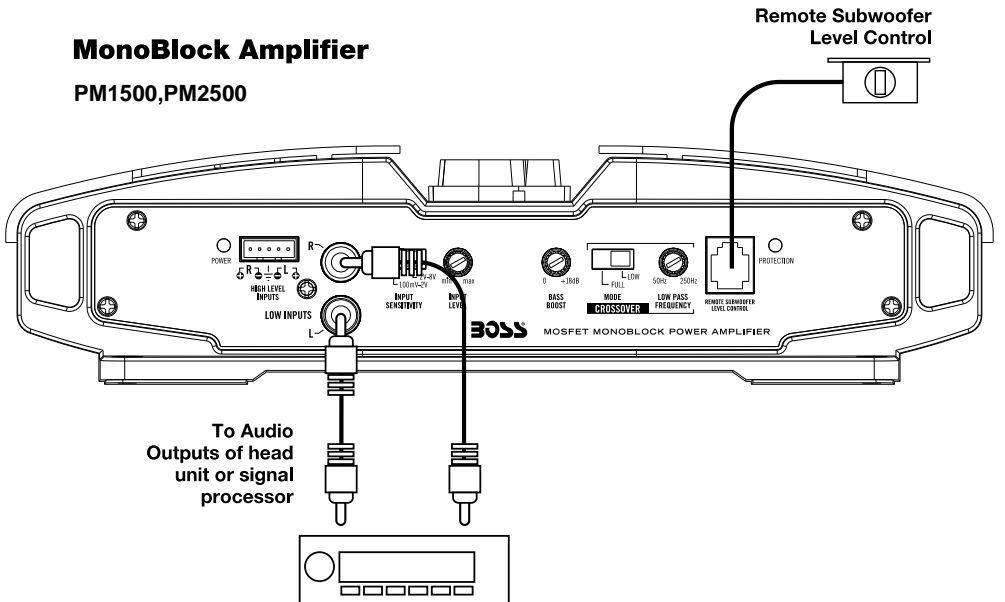



## High Level Input Wiring

The high level input(s) should only be used when your head unit lacks RCA outputs. If the RCA outputs are not present, connect the speaker outputs from the receiver to the high level input connector of the amplifier. Be sure to observe polarity to avoid audio phase problems.

**NOTE: Do not connect BOTH the high level and low level inputs from your receiver to your amplifier at the same time!**

## 2-Channel Amplifiers

PT1000,PT1600,PT2200,PT3000

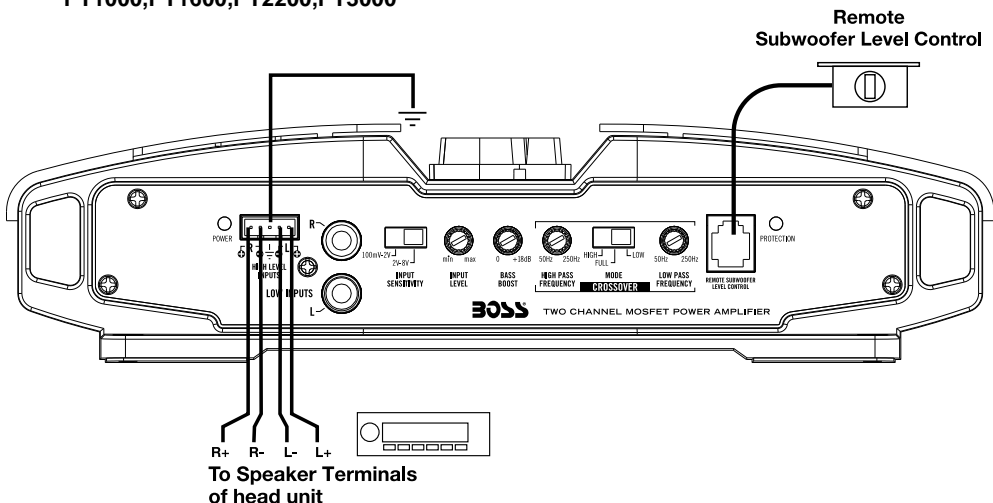

## 4-Channel Amplifiers

PF1800,PF2200,PF2600

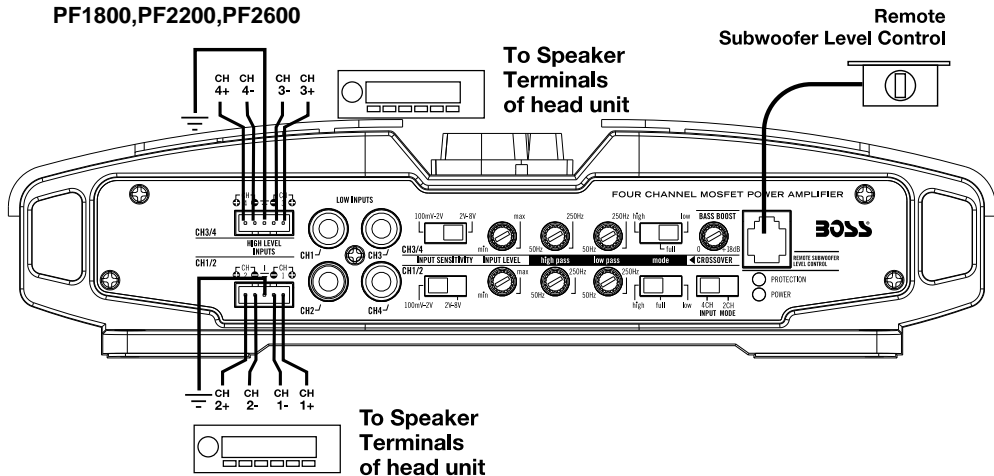

## High Level Input Wiring

The high level input(s) should only be used when your head unit lacks RCA outputs. If the RCA outputs are not present, connect the speaker outputs from the receiver to the high level input connector of the amplifier. Be sure to observe polarity to avoid audio phase problems.

**NOTE: Do not connect BOTH the high level and low level inputs from your receiver to your amplifier at the same time!**

## 5-Channel Amplifier

PV3700

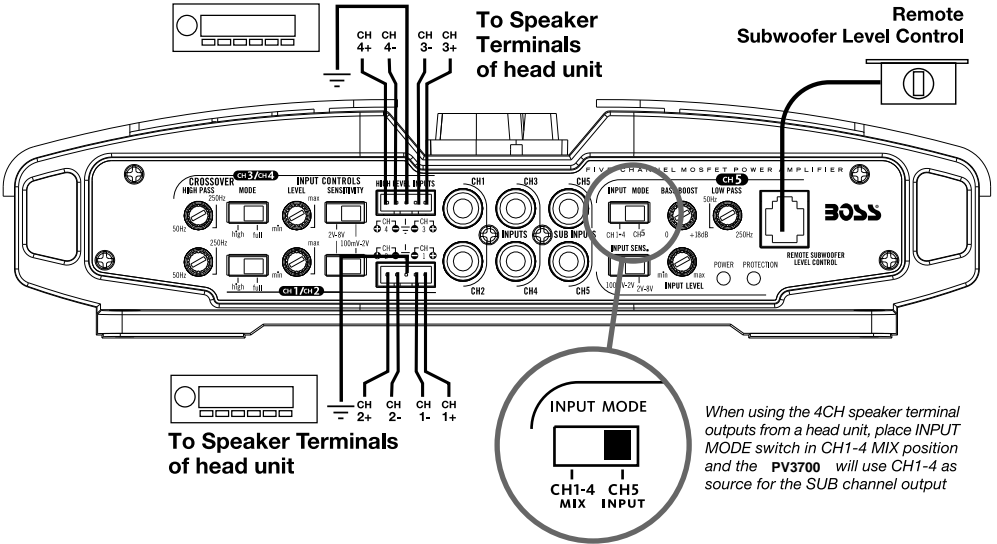

## MonoBlock Amplifier

PM1500, PM2500

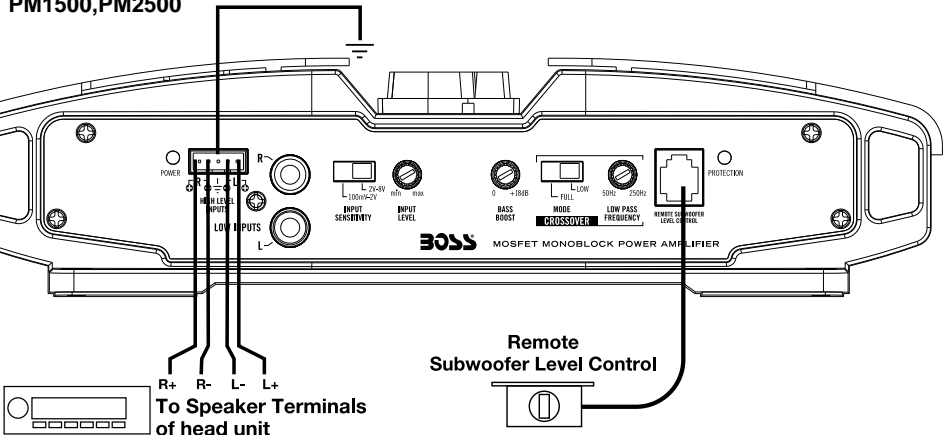

# Power and Speaker Wiring

2 Channel and Bridged Modes

# 2-Channel Amplifiers

PT1000,PT1600,PT2200,PT3000

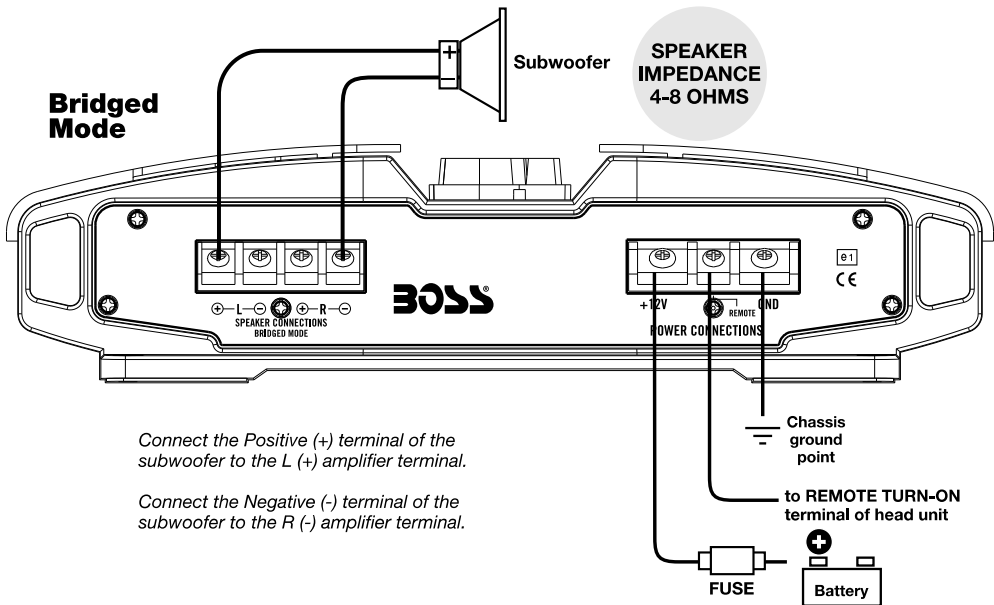
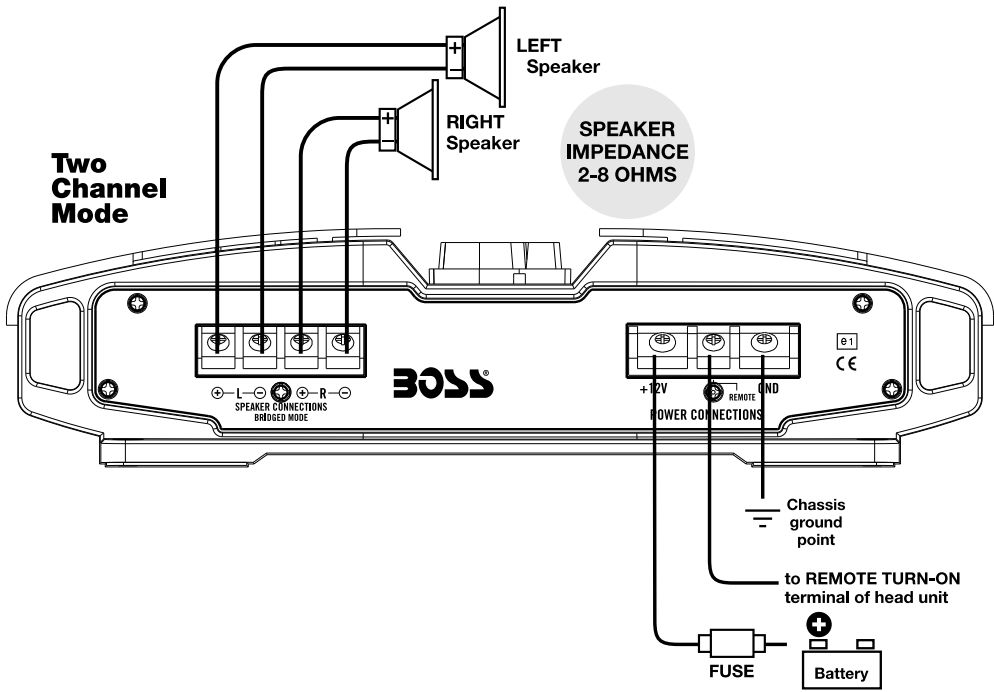

Connect the Positive (+) terminal of the subwoofer to the L (+) amplifier terminal.

Connect the Negative (-) terminal of the subwoofer to the R (-) amplifier terminal.

## Power and Speaker Wiring

Tri-Mode

## 2-Channel Amplifiers

PT1000,PT1600,PT2200,PT3000

Tri-mode operation allows you to connect this amplifier to a pair of main speakers plus a subwoofer on one pair of output channels. The main speakers will operate in STEREO while the subwoofer simultaneously operates in MONO.

To set up the amplifier to run in this mode, put the crossover switches in the FULL position. Insert high pass filter capacitors and a low pass filter inductor into the wiring as shown below. Be sure to check the table at the bottom of this page to determine the correct capacitor and inductor values for the crossover frequency you wish to achieve.

### Component values for 6dB Passive Crossover

FREQUENCY INDUCTOR CAPACITOR

80 Hz	7.5mH	470uF
100 Hz	6.5mH	330uF
120 Hz	5.5mH	330uF
150 Hz	4mH	220uF

### Tri-Mode

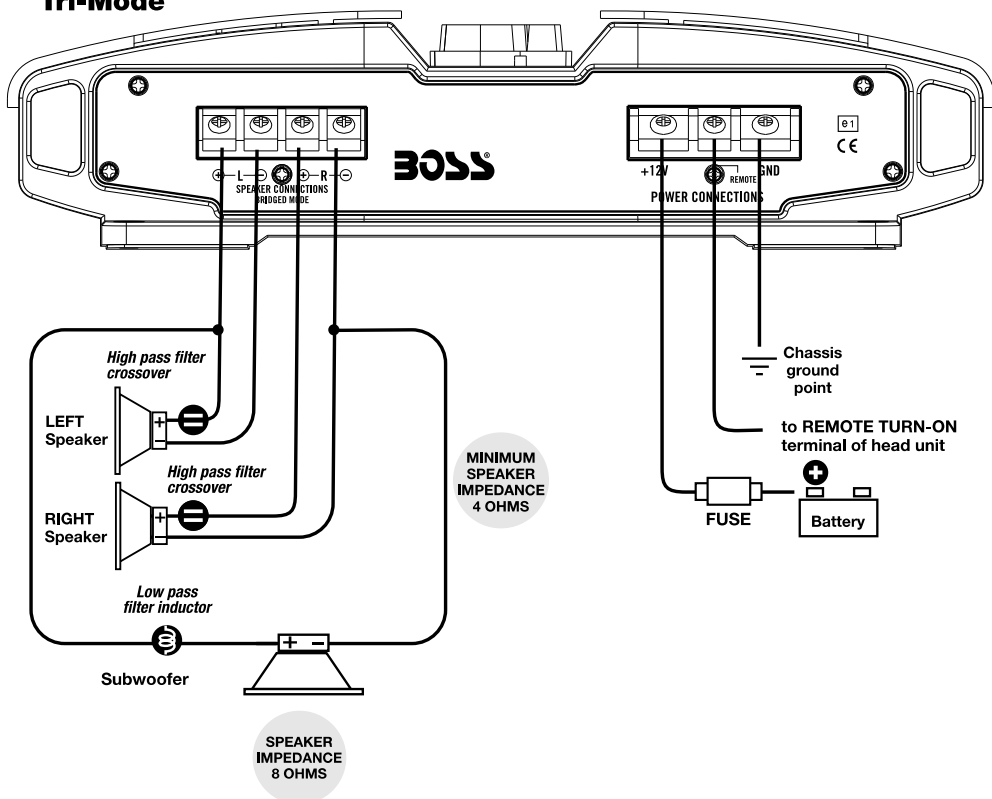

# Power and Speaker Wiring

4 Channel and Bridged Modes

# 4-Channel Amplifiers

PF1800, PF2200, PF2600

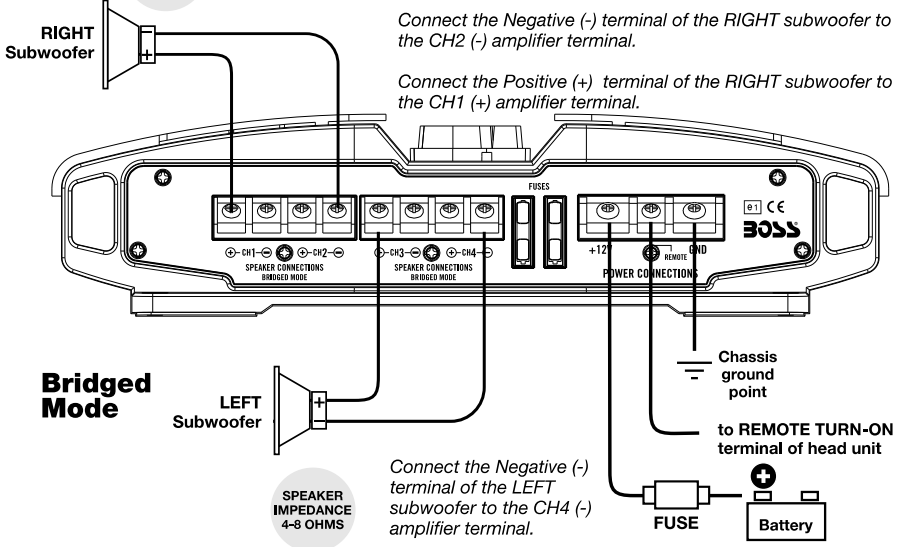
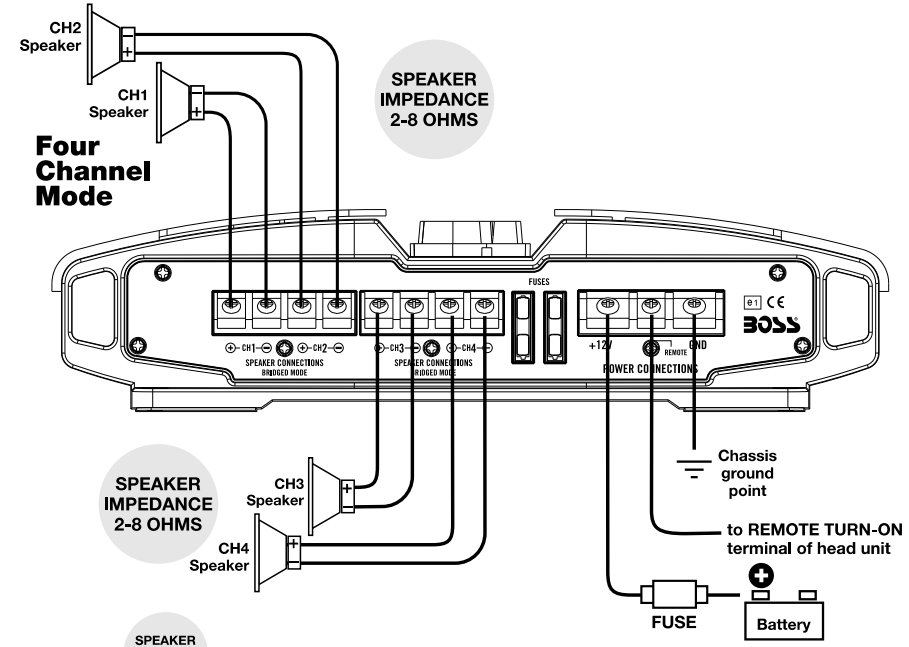

Connect the Negative (-) terminal of the RIGHT subwoofer to the CH2 (-) amplifier terminal.

Connect the Positive (+) terminal of the RIGHT subwoofer to the CH1 (+) amplifier terminal.

Connect the Negative (-) terminal of the LEFT subwoofer to the CH4 (-) amplifier terminal.

Connect the Positive (+) terminal of the LEFT subwoofer to the CH3 (+) amplifier terminal.

# Power and Speaker Wiring

Tri-Mode

# 4-Channel Amplifiers

PF1800,PF2200,PF2600

Tri-mode operation allows you to connect this amplifier to a pair of main speakers plus a subwoofer on one pair of output channels. The main speakers will operate in STEREO while the subwoofer simultaneously operates in MONO.

To set up the amplifier to run in this mode, put the crossover switches in the FULL position. Insert high pass filter capacitors and a low pass filter inductor into the wiring as shown below. Be sure to check the table at the bottom of this page to determine the correct capacitor and inductor values for the crossover frequency you wish to achieve.

## Tri-Mode

### Component values for 6dB Passive Crossover

FREQUENCY INDUCTOR CAPACITOR

80 Hz	7.5mH	470uF
100 Hz	6.5mH	330uF
120 Hz	5.5mH	330uF
150 Hz	4mH	220uF

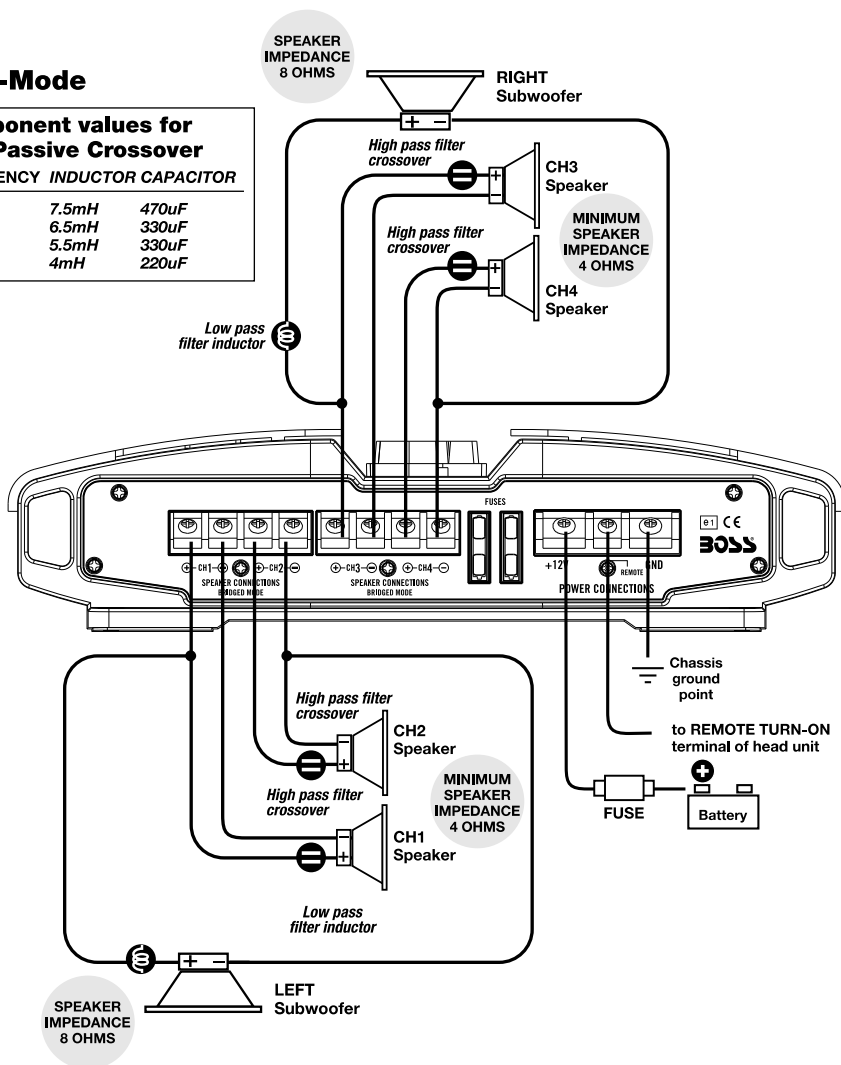

**Power and Speaker Wiring**  
5 Channel and Bridged Modes

**5-Channel Amplifier**  
PV3700

**Four Channel Mode**

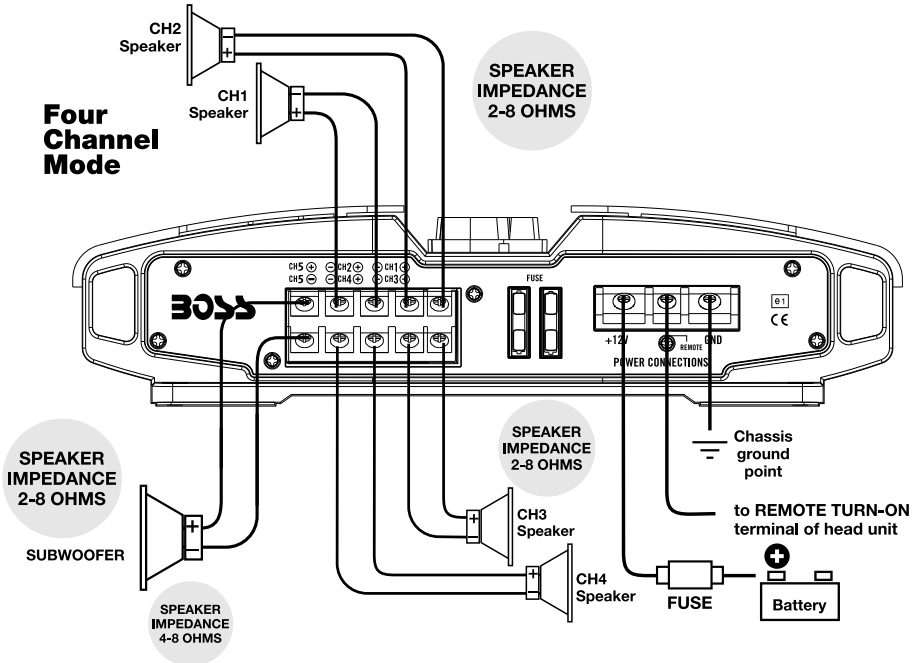

**Bridged Mode**

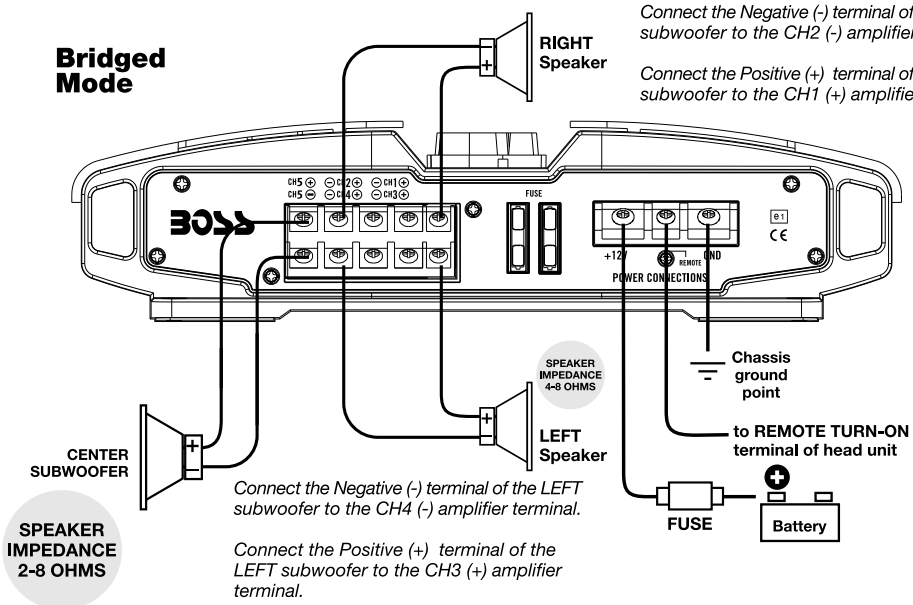

# Power and Speaker Wiring

Tri-Mode

# 5-Channel Amplifier

PV3700

Tri-mode operation allows you to connect this amplifier to a pair of main speakers plus a subwoofer on one pair of output channels. The main speakers will operate in STEREO while the subwoofer simultaneously operates in MONO.

To set up the amplifier to run in this mode, put the crossover switches in the FULL position. Insert high pass filter capacitors and a low pass filter inductor into the wiring as shown below. Be sure to check the table at the bottom of this page to determine the correct capacitor and inductor values for the crossover frequency you wish to achieve.

## Tri-Mode

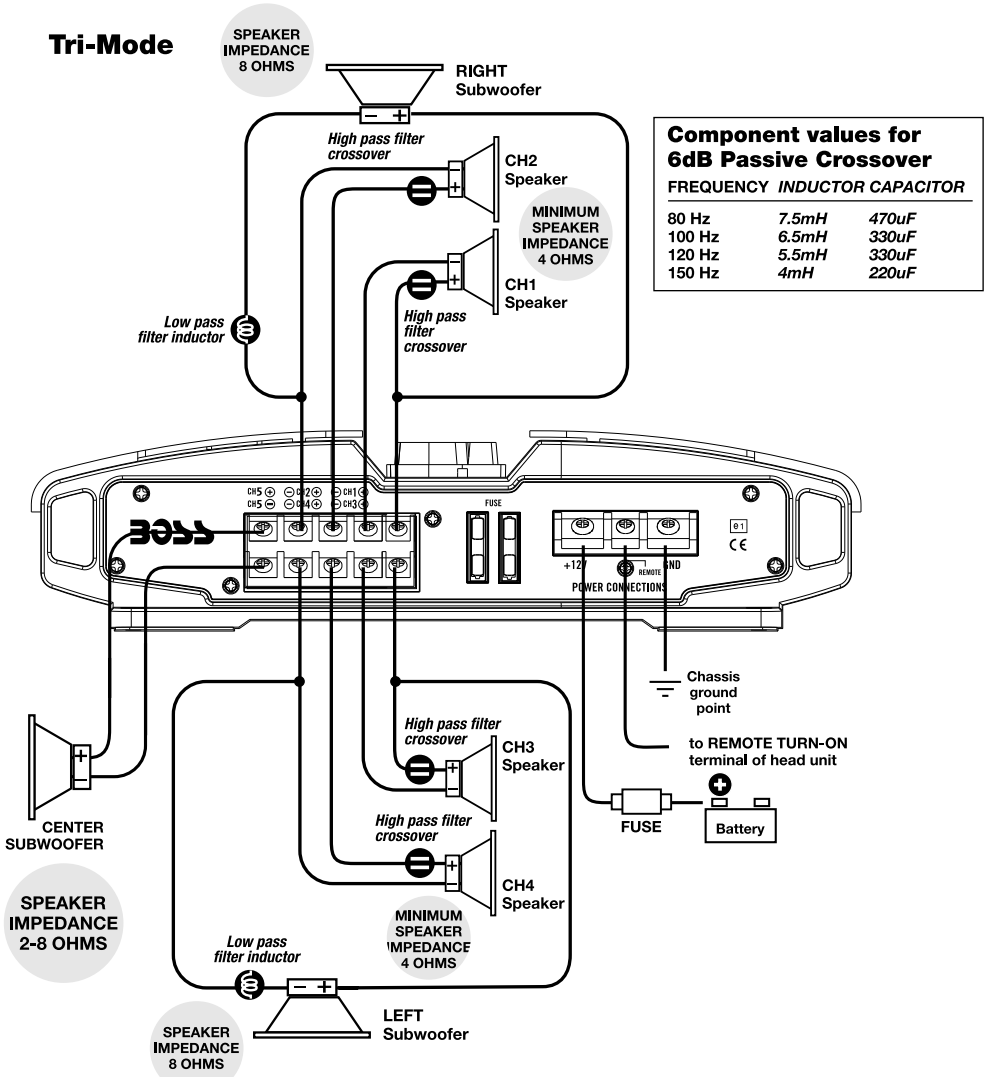



# Power and Speaker Wiring

MonoBlock Mode

# MonoBlock Amplifiers

PM1500, PM2500

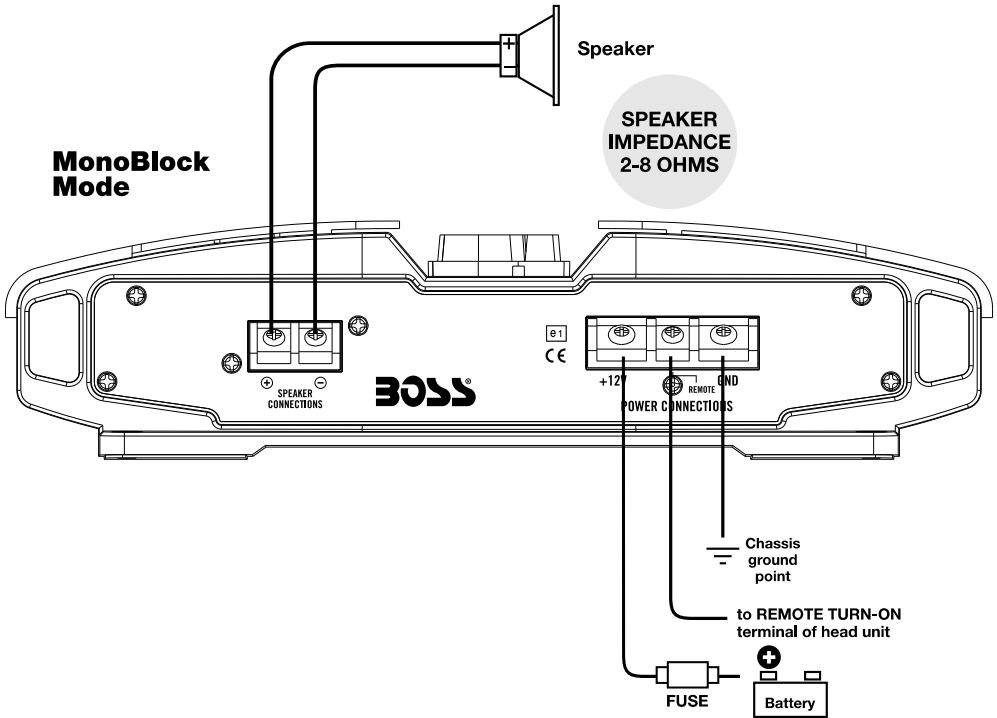

## Troubleshooting

If you experience operation or performance problems with this product, compare your installation with the electrical wiring diagram on the previous pages. If problems persist, read the following troubleshooting tips which may help eliminate the problems.

<b>SYMPTOM</b>	<b>POSSIBLE REMEDY</b>
<b>Amplifier will not power up.</b>	<p><i>Check to make sure you have a good ground connection.</i></p> <p><i>Check that the Remote Input (Turn-On) has at least 3VDC.</i></p> <p><i>Check that there is battery power on the (+) terminal.</i></p> <p><i>Check that there is at least 12v.</i></p> <p><i>Check all fuses, replace if necessary.</i></p> <p><i>Make sure that the Protection LED is not illuminated. If it is lit, shut off the amplifier briefly, and then repower it.</i></p>
<b>Protection LED comes on when amplifier is powered up.</b>	<p><i>Check for short circuits on speaker leads.</i></p> <p><i>Turn down the volume control on the head unit to prevent overdriving.</i></p> <p><i>Remove speaker leads, and reset the amplifier. If the Protection LED still comes on, then the amplifier is faulty and needs servicing.</i></p>
<b>No output.</b>	<p><i>Check that all fuses are OK.</i></p> <p><i>Check that amplifier is properly grounded.</i></p> <p><i>Check that the Remote Input (Turn-On) has at least 3VDC.</i></p> <p><i>Check that the RCA audio cables are plugged into the proper inputs.</i></p> <p><i>Check all speaker wiring.</i></p>
<b>Low output.</b>	<p><i>Reset the Level Control.</i></p> <p><i>Check the Crossover Control settings.</i></p>
<b>Audio present in only one channel.</b>	<p><i>Check the RCA interconnect cables.</i></p> <p><i>Check all speaker wiring.</i></p>
<b>High hiss in the speakers.</b>	<p><i>Disconnect all RCA inputs to the amplifiers. If the hiss disappears, then plug in the component driving the amplifier and unplug its inputs. If the hiss disappears at this point, go on until the faulty/noisy component is found.</i></p> <p><i>It is best to set the amplifier's input level control as low as possible. The best subjective signal-to-noise ratio is achieved in this manner. Try to set the head unit as high as possible (without distortion) and the amp input level as low as possible.</i></p>
<b>Squealing noise from speakers.</b>	<p><i>Check for improperly grounded RCA interconnects.</i></p>
<b>Distorted sound.</b>	<p><i>Check that the Input Level Control is set to match the signal level of the head unit. Always try to set the Input Level as low as possible.</i></p> <p><i>Check that all crossover frequencies are properly set.</i></p> <p><i>Check for short circuits on the speaker leads.</i></p>
<b>Amplifier gets very hot.</b>	<p><i>Check that the minimum speaker impedance for the amp model is correct.</i></p> <p><i>Check that there is good air circulation around the amp. In some applications, it may be necessary to add external cooling fan(s).</i></p>
<b>Engine noise (static type)</b>	<p><i>This is usually caused by poor quality RCA cables, which can pick up radiated noise. Use only the best quality cables, and route them away from power cables.</i></p>
<b>Engine noise (alternator whine)</b>	<p><i>Check that speaker leads are not shorted to the vehicle chassis.</i></p> <p><i>Check that the RCA grounds are not shorted to the vehicle chassis.</i></p> <p><i>Check that the head unit is properly grounded.</i></p>

# Specifications



## 2-Channel MOSFET Amplifiers

MODEL	PT1000	PT1600	PT2200	PT3000
<b>POWER into 2 Ohms</b>	500W x 2	800W x 2	1100W x 2	1500W x 2
<b>POWER into 4 Ohms</b>	250W x 2	400W x 2	550W x 2	750W x 2
<b>BRIDGED POWER into 4 Ohms</b>	1000W x 1	1600W x 1	2200W x 1	3000W x 1
<b>Min. speaker impedance</b>	2 Ohm Stereo 4 Ohm Mono Bridged			
<b>THD</b>	0.01%			
<b>Frequency response</b>	9Hz-50kHz			
<b>Signal-to-noise ratio</b>	103dB			
<b>Channel separation</b>	90dB			
<b>Damping factor</b>	125+			
<b>Crossover range low pass</b>	50-250Hz			
<b>high pass</b>	50-250Hz			
<b>Bass boost</b>	Variable 0 - +18dB			
<b>Fuse rating</b>	25A	25A x 2	25A x 2	40A x 2
<b>Dimensions:</b> 10-5/16"x2-1/4"x... (261mmx57mmx...)	9-1/2" (241mm)	14" (356mm)	16" (406mm)	22" (559mm)

## 4-Channel MOSFET Amplifiers

## 5-Channel MOSFET Amplifiers

## MonoBlock MOSFET Amplifiers

MODEL	PF1800	PF2200	PF2600	PV3700	PM1500	PM2500
<b>POWER into 2 Ohms</b>	450W x 4	550W x 4	650W x 4	500W x 4 +1500W x 1	1500W x 1	2500W x 1
<b>POWER into 4 Ohms</b>	225W x 4	275W x 4	325W x 4	225W x 4 +750W x 1	750W x 1	1250W x 1
<b>BRIDGED POWER into 4 Ohms</b>	900W x 2	1100W x 2	1300W x 2	1100W x 2 +750W x 1	n/a	n/a
<b>Min. speaker impedance</b>	2 Ohm Stereo 4 Ohm Mono Bridged					
<b>THD</b>	0.01%					
<b>Frequency response</b>	9Hz-50kHz					
<b>Signal-to-noise ratio</b>	103dB					
<b>Channel separation</b>	90dB					
<b>Damping factor</b>	125+					
<b>Crossover range low pass</b>	50-250Hz					
<b>high pass</b>	50-250Hz					
<b>Bass boost</b>	Variable 0 - +18dB					
<b>Fuse rating</b>	25A x 2	30A x 2	35A x 2	40A x 2	30A	30A x 2
<b>Dimensions:</b> 10-5/16"x2-1/4"x... (261mmx57mmx...)	13-1/2" (343mm)	15-1/2" (394mm)	17" (432mm)	17" (432mm)	10" (254mm)	14" (356mm)

All specifications subject to change without notice.