

**DAVIS** ®

**50** Year  
Anniversary



**50 Years of Fun  
on the Water**

ISO 9001 Certified Company



**Davis Instruments—Founded on value, innovation and tradition.**

**D**avis Instruments began in the 1960s. Some of the earliest products are still with us today although many improvements have been made to them along the way. Davis Master Sextants, a founding product, were created by Bill Davis, a tool maker with the vision for precision-molded plastic sextants at a time when metal sextants cost a thousand dollars or more.

Enter today's owners and partners, Bob Selig and Jim Acquistapace. Fresh out of Stanford Business School and unwilling to pursue careers in a corporate cube, Bob and Jim found Davis Instruments for sale in 1969. Owning their own business and applying their fresh, newly learned business principles appealed to them. They struck a deal to buy the company.

Over the years Davis earned a reputation of bringing simple, unique, problem-solving marine and leisure products to market. "Why didn't I think of that?" and "What's new this year?" are two of the most common questions encountered along the way.

Davis Marine has formed many partnerships over the decades to bring to market great products that serve our industry well. One of

the most important partnerships, lasting for many decades, is with a Swedish company called, Radab. They brought us a product commonly called the Windex, a wind vane which is very popular with sailors around the world today.

The late-1980s brought the introduction of what was to become a whole new division to Davis Instruments. It began with the acquisition of a small company called Digitar. It has now evolved into a large, innovative and world-renowned offering of weather products. Davis Weather—electronic weather stations, and web-based technologies—play a major role in our company today.

Agriculture, municipalities, meteorologists and home hobbyists all over the world know and respect the Davis brand as being the most robust and accurate weather products available at the best value.

Fifty years and tens of thousands of sextants and Windex later, Davis Instruments remains a world class leader in marine products and electronic weather stations. Many products have come and gone, but our founding products and principles are still very much respected around the world today.

This story would not be complete without mentioning the many great employees that Davis has employed over the years. Our list of 25-year veterans continues to grow every year and the list includes a few employees who earned their 25-year stripes 15 years ago.

What a wonderful and rewarding ride it has been!

## Master Sextants

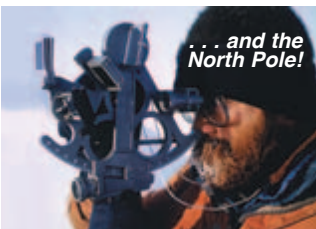
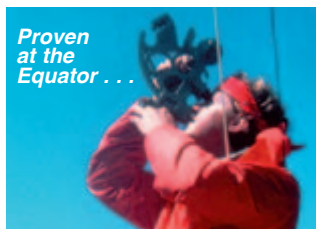

### DELUXE MARK 25 with full-field dielectric Beam Converger™



Traditional half-silvered horizon mirror

Beam Converger with full viewing field



- Full-field dielectric Beam Converger with quartz hardcoat replaces conventional half-silvered mirror. Horizon and astrobody images are combined in a single full-field for easy, reliable sights under the most difficult conditions.
- Special mineral coating is selective for different wavelengths of light. Horizon is transmitted in one color region and the star or sun in another.
- Improved reinforced plastic stiffens frame for greater measurement accuracy.
- High-efficiency LED (solid-state Light Emitting Diode) illumination system, which floods arc and drum with soft light. The LED will last for the lifetime of the sextant. Batteries, which are included, will last up to 10 times longer than with regular bulbs. This is another Davis first! Positive "push-on" switching action, with vinyl boot water protection.
- Weighs 16.5 oz. (0.47 kg)

#025

11698 00250 4

**Extra Beam Converger and Index Mirror, Spring & Screw Kit #R025F**

011698 00272 6

### Both Davis Master Sextants feature professional specifications:

- 7" (18 cm) frame radius. Graduation 120° to -5°
- Index mirror rectangular, 1.98" x 1.49" (50 x 38 mm).
- Precision machined slow travel gear and worm mechanism.
- Highly visible, easy-to-read micrometer drum and vernier allowing readings to 2/10 minute of arc.
- Fully ribbed, three-circle sextant body for platform strength and stability.
- Large, contoured handle designed for sure, steady grip and angled back for added control.
- Seven large sunshades allow complete, independent adjustment of shading density for horizon and index mirrors.
- 3 x 27 mm star telescope with anti-reflective coated glass lenses, plus separate hooded sight tube for glare-free sun shots.
- Neck lanyard frees hand and protects sextant.
- Tough, fully padded, shock-resisting carrying case with compartments for extra batteries and mirror kits.

### MARK 15

- Large, easily adjusted mirrors using new instrument-quality glass and a special baked on salt-spray resistant backing. Both mirrors have protective housings. Horizon mirror is half-silvered. No adjustment wrenches required.
- High-impact, weather-resistant plastic.
- Weighs 14.5 oz. (0.41 kg)

#026

011698 00260 3



**Extra Mirrors, Spring and Screw Kit #R026H**

011698 00271 9

**TIP** A traditional split image mirror can easily be added to the Mark 25. Order a Mark 15 Extra Mirrors, Spring and Screw Kit, part #R026H.



For simple instructions how to change sextant mirrors, see the YouTube® video: <https://www.youtube.com/watch?v=vaaVKiaKmuU>



#011



#144

**Look for the DAVIS MARK 3 SEXTANT and our ARTIFICIAL HORIZON on page 30**

# Team™ Adjustable Boat Hooks

## The Most Dependable Twist Lock and Strongest Boat Hook End!

A tough boat hook is a valuable asset when launching, docking, mooring or retrieving your favorite hat. Team telescoping boat hooks adjust to 8' or 12' (240 and 370 cm). The threaded end accepts a deck brush, mop, squeegee and other accessories. A highly visible, soft vinyl orange tip covers the threads and protects the boat's finish when fending off. All Team boat hooks float. The hook of unbreakable Lexan® is lighter than (brittle) metal alloy ends. Durability GUARANTEED to last a lifetime. Don't settle for less! Tube diameters are between 1-1 1/4" (25-32 mm).

### PRACTICAL SAILOR Says It Best:

"Davis proves to be the best pole and the best value as well."  
 "Complicated hook designs (like Davis) are preferable to get a line to a dock or piling." "It's rare to find the best product is also the best buy."  
 "They (Davis hooks) float while some sink like stones, they're light to handle, the twist-lock joints withstood a lot of pressure, and we couldn't break the heads."

"Tug Tests Take 10 Boat Hooks to the Limits," *Practical Sailor*



#5141 Boat Hook, end only to replace most 1" (25 mm) boat hooks.

011698 00169 9

## TELESCOPING BOAT HOOKS



#4122 Telescoping Boat Hook 011698 41220 4  
 2 sections. Adjusts from 53 in. to 8 ft. (140 to 240 cm).



#4132 Telescoping Boat Hook 011698 41320 1  
 3 sections. Adjusts from 38 in. to 8 ft. (100 to 240 cm).



#4152 Telescoping Boat Hook 011698 41520 5  
 3 sections. Adjusts from 54 in. to 12 ft. (165 to 370 cm).



Davis features the strongest twist-lock mechanism. Some twist-locks begin slipping at 85 lbs. (Sea Dog); some go to 175 lbs. (West Marine). The Davis twist-lock holds up to 280 lbs.

Davis boat hooks float—sometimes up to a week!

## TELESCOPING PADDLES

Paddles are required by law in many states aboard PWCs and small boats. Team adjustable paddles stow easily and telescope to 3'9" (50 to 115 cm). Our Paddle/Boat Hook combination is great to have on board and at the launch ramp. The bright orange paddle end doubles as a signaling device. Made tough for years of hard use.



#4330 Telescoping Paddle 011698 43300 1  
 2 sections. Adjusts from 20 in. to 3 ft. 9 in. (50 to 115 cm).



#4372 Telescoping Paddle/Boat Hook Combination 011698 43720 7  
 2 sections. Adjusts from 32 in. to 5 ft. 6 in. (80 to 170 cm).

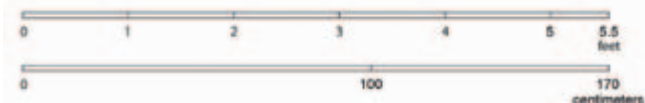

### OTHER BOAT HOOKS: Poor Value Proposition.



Garelick®  
 exploded at 150 lbs. (68 kg).



Sea Dog®  
 failed at 260 lbs. (118 kg).



Attwood®  
 exploded at 350 lbs. (159 kg).



West Marine®  
 snapped at 550 lbs. (249 kg).

These "cheaper" boat hooks all broke during recent pull testing. The Davis hook end was pulled to over 900 lbs. (408 kg) without failure.



# SHOCKLES®

## Shock Absorbing Solutions

Shockles are designed to absorb all shock loads at the dock, at anchor, on a mooring and on land. By absorbing shock loads, Shockles quiet anchor chain noise, and extend the life of dock lines and anchor lines by minimizing wear and chafe. When rigged properly, jarring from tidal surge and wind waves is eliminated increasing both comfort and safety aboard.

Davis Instruments manufactures custom Shockles that are used to capture fixed wing drones. The Boeing/Insitu Scan Eagle drone is

seen using our capture bungees on these You Tube® videos:

<https://www.youtube.com/watch?v=hMKcyTLw1OM>

<https://www.smithsonianmag.com/videos/category/innovation/watch-the-scaneagle-drone-in-action/>

These are just two examples. If you search 'Scan Eagle' or 'Insitu Drone' you will find dozens more videos.

Shockles are also used by the US Navy to retrieve surveillance drones and to launch autonomous vessels from moving ships. MBARI (Monterey Bay Area Research Institute) uses Davis custom Shockles while exploring and researching the Monterey Bay National Marine Sanctuary.



Insitu Scan Eagle Launch and Capture

## SHOCKLES LINE SNUBBER™

**Minimizes stress on ALL lines—  
for use on any boat!**

LineSnubbers feature our **progressive tension design**—the more they stretch the more tension it takes to stretch them. This minimizes the return force and dampens shock loads better than traditional rubber snubbers. LineSnubbers attach to the line by using a traditional clove hitch knot, or by using an optional Davis LineGrabber. The Davis LineSnubber is easily adjusted for varying conditions, and it can be readily be moved from line to line, unlike rubber snubbers where the line is woven into the snubber.

One size fits all boats and all line from 3/8 to 3/4 inch (10–19 mm). LineSnubber can be attached to 1 inch rope (25 mm) by using a Davis LineGrabber #2460.



LineSnubber is stronger than most double-braided line. For example, SWL on 5/8 inch (16 mm) double-braid is 3500 lbs. (1590 kg). When properly rigged and LineSnubber reaches maximum stretch, the line bears the load, not LineSnubber. Internally, a **PATENTED Line Stretch Limiter** is combined with marine-grade elastomer for durability and strength. Hollow, UV resistant nylon webbing is sewn over the internal mechanism and two 316 stainless steel carabiners allow for quick and easy attachment.

Many LineSnubbers are going strong after ten years!

### For marine applications:

- LineSnubber reduces shock to any line, cleat or ground tackle, including bow rollers and rigging
- Attaches, adjusts or removes quickly; use a simple clove hitch or a pair of Davis #2460 LineGrabbers (see page 5)
- Reduces or eliminates noise from creaking, groaning dock lines or ground tackle—jarring is minimized, too
- Compensates for tidal surge and chop from wind and waves
- Rigged properly, LineSnubber keeps boats centered in the slip



Docking



Tender Towing



Boom Tie Down



Spinnaker Tack



Boom Preventer



Anchoring

Shockles are strong, but should always be rigged in-line with the load. Never allow them to bear a load alone. Allowing a maximum of eight inches (20 cm) of slack before the line bears the load will result in many years of service from LineSnubber.

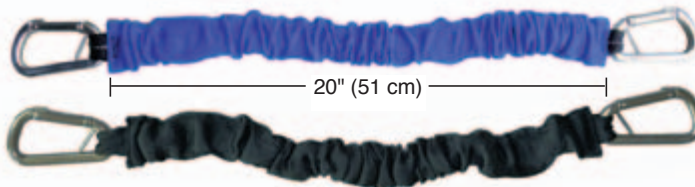

#2400 LineSnubber, blue

011698 01055 4

#2410 LineSnubber, black

011698 01956 1

PATENTED



# SHOCKLES® DOCKSHOCKLE™

**Smaller can be better.**

DockShockle was designed to prevent wear and tear on all lines on smaller, lighter boats up to 40 feet (12 m). The same **Progressive Tension Design** and **PATENTED Line Stretch Limiter** are used in this smaller version of our LineSnubber. DockShockle comes with a pair of Mini LineGrabbers and two 316 stainless steel carabiners. Use on line from 3/8 to 3/4" (10–19 mm). The webbing is 12" long (31 cm) in the relaxed position.



**Sailboats**



**Powerboats**



**Inflatables**

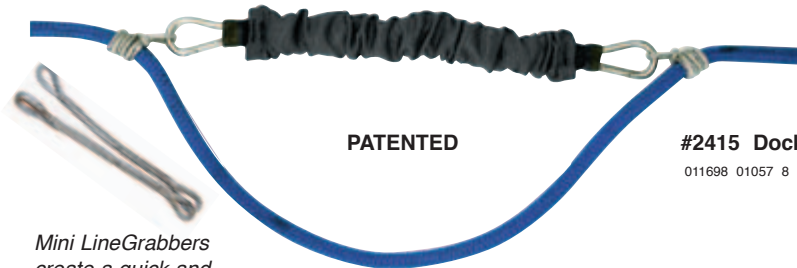

**PATENTED**

**#2415 DockShockle, black**

011698 01057 8

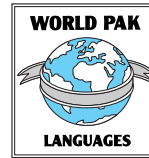

*Mini LineGrabbers create a quick and secure attachment loop by using a basic Prusik hitch.*

DockShockle should be set up with 3–6" (8–15 cm) of slack in the line to safely absorb and buffer shock loads caused by wind, waves, chop and tidal influences.

**TIP** Use DockShockle on floating docks as a stabilizer.

**TIP** Keep helical screw anchors set by using DockShockle to absorb constant, tugging loads.

## LINEGRABBER™

**Hundreds of uses!**

Made of 1/4" (6 mm) ultra-high molecular polyethylene fiber with a sewn loop at each end, LineGrabber measures just 9" (23 cm) overall length. Create a strong attachment loop in line from 3/8 to 1" (10–25 mm) by using a basic Prusik hitch. UHMP fiber rope is tough and durable enough to attach to anchor chain, toe rail, shackles, rails & pulpits, roof racks, etc. to create a secure attachment loop that will hold up to 2000 lbs. (900 kg) tensile strength.



- Toe Rail
- Cleat
- Grab Rail or Pulpit
- Vehicle Rack

LineGrabber safely carries loads to help solve challenges that pop up like a fouled jib sheet, loose anchor, missing dock cleat, or a bow eye that's too small. Sold in pairs.



**Create an Attachment**



**Unload a Sheet**



**Grab a Railing**



**Secure a Chain**



**#2460 LineGrabber, PAIR**  
9" end to end (23 cm)

011698 01079 0

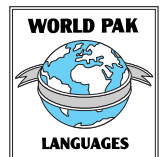

## STAINLESS STEEL HARDWARE

**Same high quality snaps used in our Shockles® products**

Polished 316 stainless steel stands up to the toughest marine and outdoor environments. Very competitive prices.



**#2470 Carabiner.** Captive, 3/8" stock (10 mm) by 3 7/8" long (10 cm). Safe working load 1200 lbs. (500 kg).

011698 01080 6

**#2480 Key Pin Halyard Shackle.** Captive, 5/16" stock (8 mm) by 3 1/16" long (8 cm). SWL 1500 lbs. (700 kg).

011698 01081 3

**#2490 Wire Gate Snap.** 1/4" stock (6 mm) by 2 3/8" long (6 cm). SWL 415 lbs. (188 kg).

011698 01082 0

**#2500 Wire Gate Snap.** 5/16" stock (8 mm) by 3 1/8" long (8 cm). SWL 968 lbs. (438 kg).

011698 01083 7

## MINISHOCKLE™

*What is your load worth?*

Featuring a stainless steel wire snap rated to 300 lbs. (136 kg) Safe Working Load, this is truly a bungee cord on steroids. Take MiniShockles boating, camping, fishing or hiking—anywhere you want to secure a load. We all carry valuable things on our boats, RVs, automobiles and off-road vehicles. And, we have all been disappointed by standard bungee cords with hook ends that often hold just 36 pounds (16 kg). UV resistant nylon webbing is sewn over marine-grade elastomer for durability and strength. Three sizes. Black.

**Minishockles—strong, tough, secure.**



**Sailing**



**Camping**



**Fishing**



**RVs**



*Stainless steel wire gate snap*



#2430 MiniShockle 12" (31 cm)  
011698 01059 2

#2440 MiniShockle 18" (46 cm)  
011698 01063 9

#2445 MiniShockle 24" (61 cm)  
011698 01067 7



## ANCHORSNUBBER™

*Keep your anchor set.*

AnchorSnubber quiets chain noise and helps keeps your anchor set by minimizing shock loads. Use directly on chain, anchor rode, or snubber line. Made with the same features employed in LineSnubber—**Progressive Tension Design** and **PATENTED Line Stretch Limiter**. Comes with two 316 stainless steel key pin shackles that can run through most bow rollers and compensate well for chain twist. Fits most anchor chain. Webbing is 20" (51 cm) long. Black.

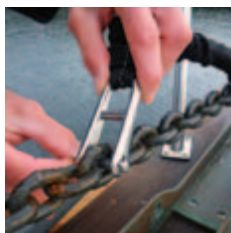
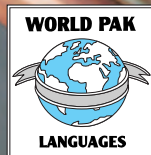
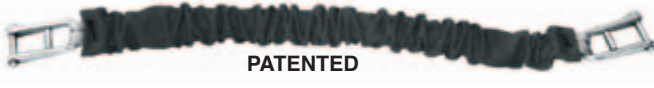

*Attach to the chain before the bow roller. The key pin shackle will run through most bow rollers. It's ideally suited to withstand side loads associated with chain twist. Always set up with slack in the chain. The slack only needs to be 4–6" (10–15cm) to take the load off the capstan and quiet chain noise.*

#2420  
**AnchorSnubber, black**

011698 01058 5

## FENDERFRIEND™

*Every fender needs a friend.*

FenderFriend is a fender whip, fender hanger and fender adjuster—all in one. Anyone can attach fenders quickly and easily. Attaches almost anywhere.

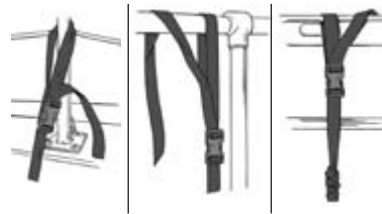

Stretches when fenders get pinched between the hull and the dock. Minimizes loads on stanchions, rails, cleats and lifelines. UV resistant nylon webbing is sewn over marine-grade elastomer with a Nexus® nylon buckle for superior strength. Strap adjusts from 16 to 72" (0.4–1.8 m). Trim strap to useful length with sharp scissors and heat-melt the trimmed strap end.

Two models to choose from; Twin-Eye or Center-Tube. Sold individually. Black.

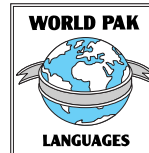

#2450 **FenderFriend, Twin-Eye, black**  
011698 01071 4



#2455 **FenderFriend, Center-Tube, black**  
011698 01075 2



**Built-in shock absorber stretches 12 inches (31 cm)!**



*Tighten or loosen strap to adjust fender height.*

*A little bit of stretch helps keep fenders in place.*

# ROCKER STOPPER™



A hydrodynamic device scientifically designed to stabilize a boat moored, anchored, or drifting.

**The more wind and waves, the better RockerStoppers work!**

With engines off or sails down, you feel the sea as you stop for meals, fishing, rest or sleep. Rocker Stopper is the solution—efficiently dampening the effects of waves and wake on a stationary boat. Designed for rugged use.

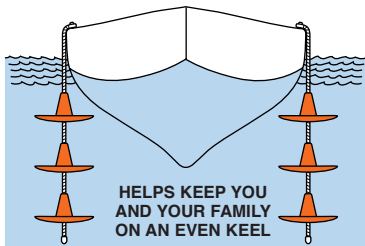

HELPS KEEP YOU AND YOUR FAMILY ON AN EVEN KEEL

For sailboats, powerboats, fishing boats, too!

Lightweight and molded of high-impact, virtually indestructible styrene. Can be deployed or retrieved in seconds. Salt water resistant, gentle to the sides of your boat. Units “nest” within each other, so storage is a breeze.

**TIP** Rocker Stoppers are excellent for slowing drift while fishing, and can also be used as a dock stabilizer.

### Number of Rocker Stopper Units Needed on Each Side of a Boat

Length of Boat	Length of Boat	Number of Units
Up to 26 feet	(0 – 8 m)	3
27 to 36 feet	(8 – 11 m)	4
37 to 42 feet	(11 – 13 m)	5
43 to 50 feet	(13 – 15 m)	8

#352 Rocker Stopper, individual unit

011698 03520 5

14" (36 cm) dia. 1 lb. (.45 kg) weight

# FENDER TENDER II™

The original! Grips all!



Use this Davis accessory to clip your fenders to rails, lifelines, side wing windows or cleats. Fender Tender II simplifies the handling and relocation of boat fenders. “Railing Lock” firmly grasps rails from 7/8" to 1" (22 to 25 mm) diameter. “Lifeline Lock” provides added safety. Use 1/4" to 3/8" (6 mm to 9 mm) diameter nylon line. Made of tough, sun-resistant plastic for many years of use. Helps tidy up your boat.

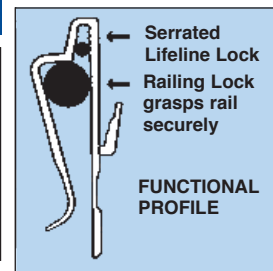
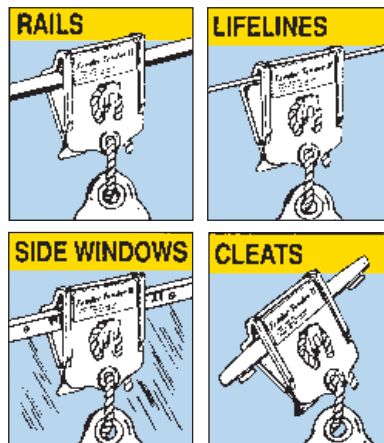

#393 Fender Tender II, PAIR

011698 03930 2

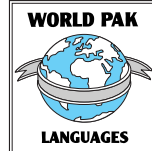

# SECURE CHAFE GUARDS



Now available in black

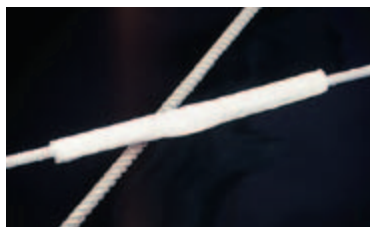

## Protect Your Lines with Removable/Adjustable Chafe Guards

Chafe protection is critical at the dock, at anchor or on a mooring. Davis offers a great solution to prevent chafing over a cleat, cap rail, where two lines cross or at the anchor roller. Dock lines can be expensive—extending their life with good chafe protection is not!

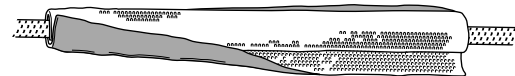

Velcro® hook fasteners along ENTIRE interior grip the line—no need for additional ties

Secure Removable Chafe Guards fit braided or twisted line from 3/8 to 1" (10–25 mm). They're easy to remove and adjust as lines stretch or chafe protection is needed elsewhere. Great for dock, mooring and anchor lines where wearing through a line could cost you the boat. The outside cover is made of tough, UV-stabilized nylon webbing. The inside is lined with 100% Velcro® to grip the rope.

#395 Secure Chafe Guards, White. Pair. 011698 03950 0

#397 Secure Chafe Guards, Black. Pair. 011698 01269 5

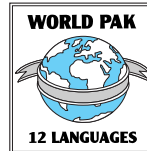

# Wheel-a-Weigh™

LAUNCHING WHEELS

**Get your small craft to and from the water quickly, safely, easily!**

Mounts wide on the transom to distribute the load and leave clearance for outboard motors.

The boat can be operated without removing the wheels in most cases.



**#1482 STANDARD**  
For loads up to 220 lbs. (100 kg)

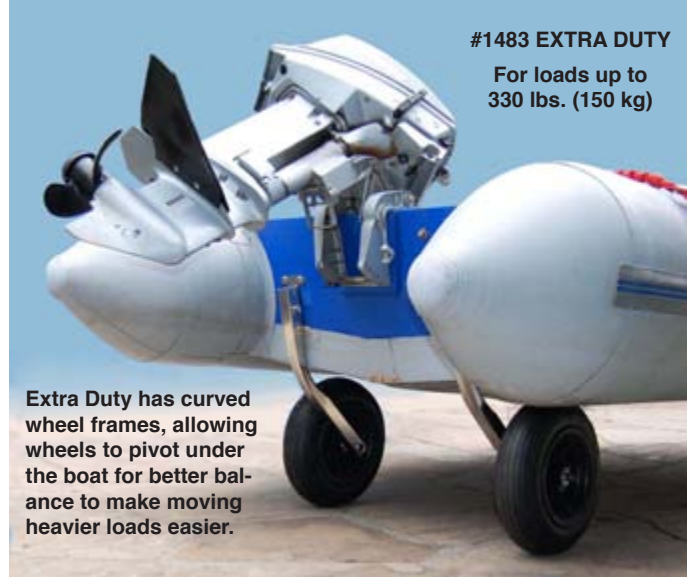

**#1483 EXTRA DUTY**  
For loads up to 330 lbs. (150 kg)

Extra Duty has curved wheel frames, allowing wheels to pivot under the boat for better balance to make moving heavier loads easier.

**Wheel-a-Weigh features:**

- Portable and removable
- 316 stainless steel frames and pivot brackets
- Inflatable tires
- Precision molded, non-corrosive wheel hubs
- Stainless steel installation hardware included
- Easy-to-follow instructions



Fully illustrated instructions make installation simple.

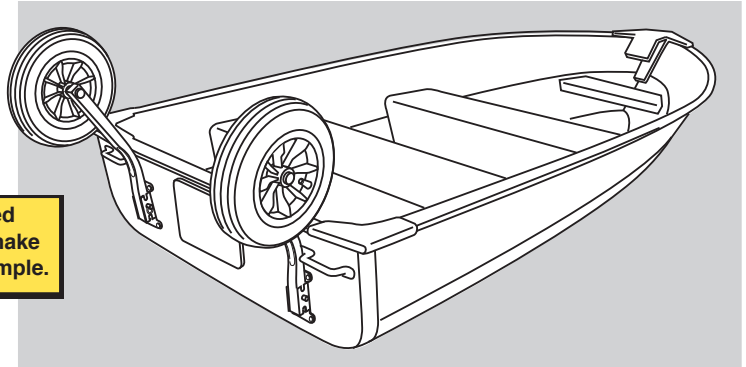

**INSTALLED ON ALUMINUM BOAT**

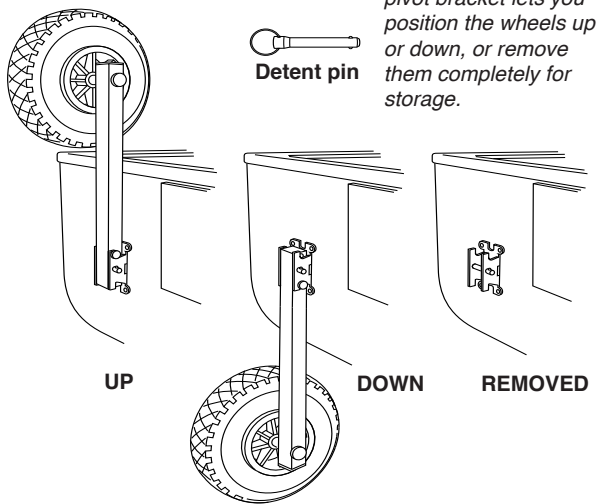

**#1482 Wheel-a-Weigh Standard** with 10" (26 cm) inflatable tires.

220 lb. capacity (100 kg) handles most boats with motors up to 10 HP.

Weighs 9 lbs. 4 oz. (4.2 kg).



**#1483 Wheel-a-Weigh Extra Duty** with 14" (36 cm) inflatable tires and roller bearings inside hub. Curved wheel frames pivot under the boat for better balance.

330 lb. capacity (150 kg).

Weighs 15 lbs. 11 oz. (7.2 kg).

Wheel-a-Weigh products are not designed to be towed behind a vehicle.





**Enjoy the ride! 100% Satisfaction Guaranteed**

Over three decades of testimonials and 1,000,000 customers agree that Doel-Fin delivers!

Doel-Fin is the original hydrofoil developed by an aeronautical engineer to **improve overall performance on boats with outboard motors or outdrive units**. Molded in two pieces of guaranteed unbreakable, high-strength plastic, each foil is designed to flex independently to absorb shock. The positive effects include greater stability, consistent planing at lower RPM, faster out-of-the-hole performance, steadier turns, higher top-end speeds and lower bow rise at all speeds.

- Doel-Fin improves overall performance— even on boats with well-designed hulls
- Save up to 30% on fuel consumption
- Faster out-of-the-hole for happier water-skiers
- Maintain lower planing speeds without constant throttle adjustments for wakeboarding, tubing or beginning skiers
- Less bow rise for better visibility and increased safety
- Simple 15-minute installation; hardware included

Doel-Fin is designed for use with small motors, big motors, and inflatable dinghies. Boats with small motors no longer “porpoise” with the bow-up when the throttle is applied and achieve planing at lower engine speeds. Big motors benefit from less stern suction, faster planing times and steadier turns. All these features add up to increased fuel efficiency.

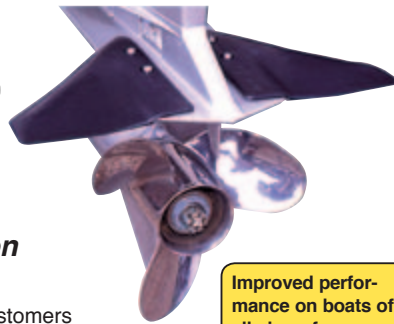

Improved performance on boats of all sizes, from small dinghies to large ocean cruisers!



**Balanced Performance**

Doel-Fin was designed to produce maximum lift while minimizing drag. Creating lift in the stern compensates for motor weight for smoother turns, better gas mileage and less stern drag.



#440  
**DOEL-FIN Stabilizer, set of left and right fins, black**

011698 00185 9

Fits all motors except Volvo Penta® 280 and 290 outdrives.

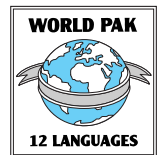

**Aluminum Stabilizer and Ski Boat Fin**



#448  
**WHALE TAIL XL Stabilizer & Ski Boat Fin**  
011698 00639 7

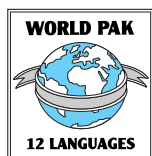

The **Whale Tail XL** unique hydrodynamic design extends behind the prop to utilize prop wash energy which is normally lost. Whale Tail transforms this energy into lift for immediate response when the throttle is applied. Use Whale Tail XL in fresh or saltwater.

**Improves performance in any I/O or outboard motor**

- Pops skiers up in less time
- Flattens wake for waterskiing; creates positive, skid-free turns
- Stabilizes bow-light boats
- With bow lowered, visibility and safety are improved
- Smooths out ride in rough water
- Reduces porpoising & cavitation
- Increases top speed and fuel savings in most applications
- Mounts on the anti-cavitation plate of all inboard/outboards and outboards
- Installs in 15 minutes with stainless steel hardware included
- Marine grade aluminum with durable anodized finish

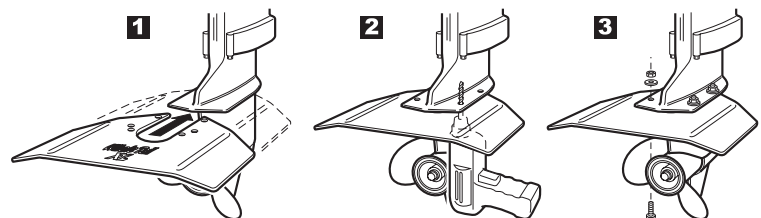

*It's simple! Position Whale Tail XL on the horizontal plate right above the propeller, clamp in position and drill, secure with bolts. See complete instructions included.*



# IT'S EASY TO PREVENT STEERING PROBLEMS!

KEEP WATER & DIRT OUT...

... PUT LUBRICANT IN!

THE ONLY PRODUCT THAT LUBRICATES STEERING CABLE

**CABLE BUDDY™**

#420

SEALS AND LUBRICATES STEERING ROD

**LUBE II™**

#425

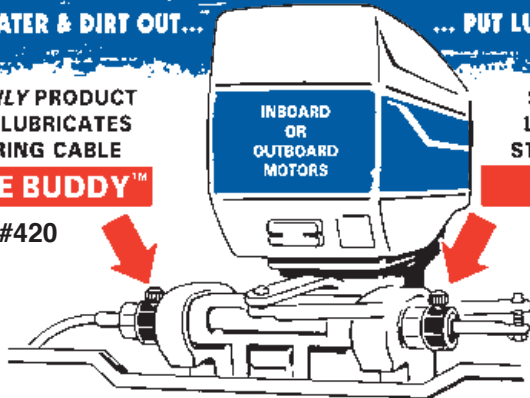

7/8" x 14 pitch threads fit U.S. and Japanese outboard motors



Max-Lube™ oiling-tube method (Lube II shown)



STEERING CABLE LUBRICATION SYSTEM



STEERING ROD SEALER & LUBRICATOR



EXTREME SERVICE LUBRICANT

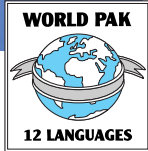

Cable Buddy is a complete steering cable lubrication system. Includes the stainless steel Cable Buddy nut with plug and sealing washer, oiling tube assembly, and Max-Lube, the ideal lubricant for steering cables. Works on inboards, outboards, and inboard/outboard steering cables. Fits all major U.S. and foreign motors (7/8" x 14 pitch threads). Seals moisture out, puts lubricant in. Prevents corrosion and freezing down to -40°F (-40°C). Cable Buddy lubricates and virtually eliminates all wear in the *inner* cable, where *most* problems occur. Easy to install (if you can take the cable off, you can install the Cable Buddy). Install the Cable Buddy now...or deal with the hassle and expense of replacing your steering cable later!

**#420 Cable Buddy**  
with 1 lube nut & Max-Lube  
011698 04200 5

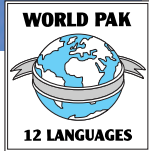

Lube II allows sticky, hard to move steering rods to be properly and easily lubricated for smooth, easy steering action. The system includes a stainless steel lubricating nut with an oil seal and a grease (zerk) fitting. This lubricator's unique design keeps moisture and contaminants *out* while enabling you to pour or pump several types of lubricant *in*. Your choice: (1) Max Lube (#422) synthetic lubricant with high water separation qualities and anti-corrosion protection. This is the best lubricant available for the purpose. (2) A high grade 90w synthetic gear oil. (3) High quality white lithium grease. Lube II helps correct and prevent steering problems. For both mechanical and hydraulic systems. Fits all major U.S. and foreign motors (7/8" x 14 pitch threads). Easy, 10 minute installation. Marine grade stainless steel for salt and fresh water use.

**#425 Lube II**  
011698 04250 0

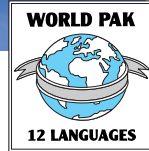

Max-Lube excels under pressure— anywhere oil is required. This proprietary synthetic film has many advantages over other synthetic and premium oils: superior rust and corrosion protection, rapid separation from water, greater stability at temperature extremes, 10–20% reduction in operating temperature, and 5 times greater load carrying. The net result is smoother, quieter, cooler and longer operation. Max-Lube is recommended for steering cables (all boat motors, fresh or salt water), sporting equipment (fishing reels, guns, bike chains), all gears regardless of type or size, and all metals.

**#422 Max-Lube**  
3 fl. oz. • 90 ml  
011698 04220 3

**DAVIS**

# HAPPY TROLLER®

For the Fisherman who *thinks* he has everything!

**Slows even big motors down to that "ever-so-slow" fish tantalizing speed**

**Happy Troller is the answer to correct trolling speed**

A significant advancement in the sport of troll fishing, **Happy Troller** mounts on the anti-cavitation plate to allow fine control of trolling speed. Your boat's stability is enhanced at cruising speed for a smoother ride in rough water, reduced porpoising and cavitation.

**Use it year-round in all boating activities—great for use in both salt and fresh water**

Made of highest quality stainless steel and marine aluminum, with clear anodized aluminum finish. Installs in 15 minutes with hardware included. Comes with full installation and operating instructions.

**Two Models:**

**Large** fits inboard/outboards plus all outboard motors 50 HP and larger.

**Small** fits outboards from 25 to 50 HP.

**#460 Large Happy Troller**

011698 00635 9

**#461 Small Happy Troller**

011698 00636 6



**Two sizes fit all I/Os and outboard motors**

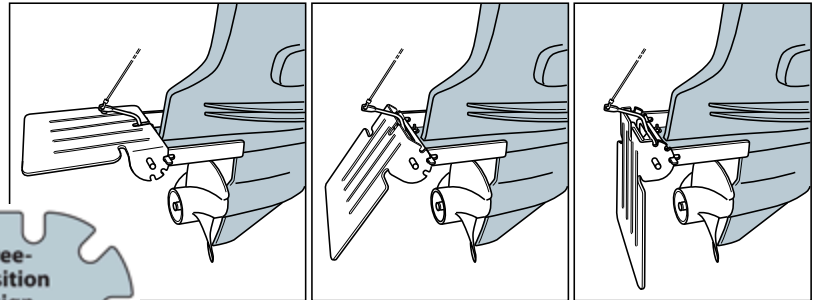

Three-position design for added flexibility

**Locks in "up" position for cruising, "down" for trolling, with middle position for ultimate trolling control!**

For motors under 25 HP, see Lil' Fella™ product #462.



# lil' fella™

Trolling Plate

Little brother to the Happy Troller®

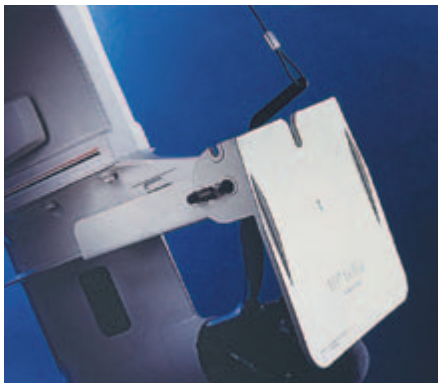

**A fisherman's answer to correct trolling speed**

- Fits all outboard motors up to and including 25 HP
- Locks "down" for trolling, "up" for cruising
- Made of highest quality polycarbonates with stainless steel hardware, included
- Comes with full installation and operating instructions

For motors above 25 HP see Happy Troller® products #460 and #461.



**#462 Lil' Fella Trolling Plate**

011698 00637 3



**Precisely Sets Your Trolling Depth!**

Great for SALMON, TROUT, STEELHEAD, WALLEYE, CRAPPIE and STRIPER.

**Turns over and surfaces when fish strikes**



Trolling at 2 MPH with Fish Seeker, you can choose any trolling depth from 5 to 80 feet (1.5 to 25 m). Simply choose the right setting for desired depth, let out enough line and troll at slow speed. For salt or fresh water fishing and 6–25 pound test line. A good replacement for outriggers or heavy lead ball sinkers. Not for use with deep diving lures.

**#510 FISH SEEKER, chartreuse**  
011698 00188 0

**#511 FISH SEEKER, hot pink**  
011698 00189 7

**#512 FISH SEEKER, clear**  
011698 00190 3

**How Fish Seeker's depth is controlled:** Using a chart supplied with the product, attach your rod line snap swivel to a lettered hole and your leader snap swivel to a numbered hole. Release the amount of line specified, and Fish Seeker will dive to the desired depth.





The Original

# Windscoop™ Ventilating Sail

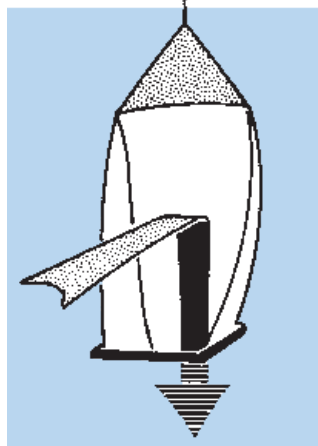

Put an end to hot, stuffy cabins and sleepless nights. The Windscoop Ventilating Sail is aerodynamically designed to force the slightest breeze into your cabin to keep you cool and comfortable. The versatile Windscoop can be hung from a halyard, boom or roller furling sheet. Fits any hatch or companionway up to 4 feet (120 cm) wide. Nothing to install. Since the Windscoop has no tie-downs, once you put it up, it will follow a variable wind. Works with most screens. Colors vary.

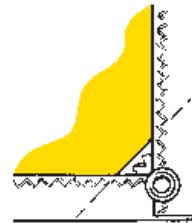

*Added material and strengthening in stress areas. Two battens are sewn in place. All seams are double-stitched.*

#291  
Windscoop  
011698 00176 7

Windscoop is packed in its own protective nylon storage bag.

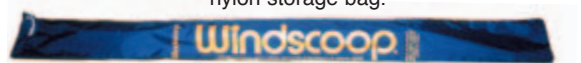

**POWERBOATERS!** It's easy and inexpensive to adapt WINDSCOOPS for powerboat use. Click "Instruction Manuals" on the Marine Support menu at our website.

## HANDI-MATE™ Outboard Extension Handle



**Handi-Mate** extends handle from 30 to 47" (.76 to 1.19 m). Easy to install—tough polycarbonate head quickly clamps over existing handle grip. Does not affect throttle tension adjustment. Depress button & align proper hole for desired length. Non-slip comfort grip, access hole for kill button.

**Fits Virtually All  
Twist Grip  
Outboard Motors!**

#1440  
**Handi-Mate extension handle**  
Straight steering unit.

0 11698 00641 0

- Lightweight—only 16 oz. (454 grams)
- Turn-locking knob makes securing & removing easy
- Anodized aluminum—no parts to rust or corrode
- Stainless steel hardware



**Protection for  
Propellers and  
People**



Prop Sox are socks for your prop. They protect your expensive propellers from road kickback when towing. Reflective hot dots alert drivers following too closely behind. People walking by a boat on a trailer can be cut without Prop Sox in place. The bright, molded plastic socks simply slip over each propeller blade and are held in place with a rubber shock cord strap. For use on boats out of water only.

#450 Prop Sox Set of 3

011698 00186 6

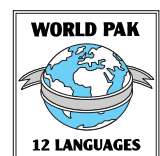

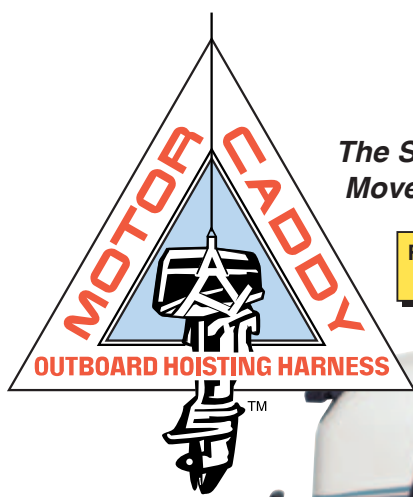

The Safe and Easy Way to Move an Outboard Motor

Fits 4-stroke motors up to 15 HP



**Motor Caddy** is sized to be quickly attached to most outboards from 2–15 horsepower. This improved design features a longer strap to fit 4-stroke motors and an added security strap for today's streamlined engine cases. Made of UV resistant materials that will endure the marine environment for those who prefer a semi-permanent installation. Glass filled Nexus® nylon buckles insure easy installation and removal. Makes lifting and moving cumbersome motors safer, simpler.

#430 Motor Caddy  
Outboard Hoisting Harness

011698 04300 2

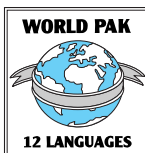

## RUDDER POSITION INDICATOR



Avoid Veering—  
and Collisions!

Awareness of the rudder angle is a most important safety factor. This is especially true while moving in and out of your berth, drawing alongside another boat, picking up a skier, mooring, or any other "close call" situation. Davis' Rudder Position Indicator gives instant visual reference of rudder angle. The pointer swings a full 30° with each revolution of the wheel. Mounts easily with its self-adhesive pad directly to your hub. Indicator is approximately 2" (5 cm) in diameter. Rugged, hermetically sealed, weatherproof and sunproof housing ensures long life. No cables, adjustments, or electricity required; gravity power makes it simple and service-free. Suitable for boats with mechanical and single station hydraulic steering systems.

#385  
Rudder Position Indicator

011698 03850 3

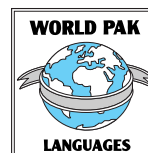

# SWIM STIRRUP™

The Safe Solution  
to a Slippery Situation



- Perfect for rowboats, ski boats, dinghies, sailboats
- Adjustable length to fit your boat
- Complete hardware and instructions included
- Easy to install, easy to use—it even floats!

#1466  
Swim Stirrup

011698 00649 6

The **Swim Stirrup** provides safe, easy access to small boats for swimmers or water skiers. Durable, reliable design attaches to gunwales, transoms, or open bows.

## Line Snubber™

A Shock Absorber  
for Your Lines



For fishing lines, too!

**Line Snubber** helps reduce stress and wear on your lines and cleats. They're available in 22" length (56 cm). Molded of highest quality rubber for years of service. Packaged in pairs.

Sailors, fishermen and other boaters will find many uses for Line Snubber, from anchor snubbing to trailering. Using them on parallel lines maximizes their effectiveness. Sailors can use them to lash a tiller, tie down a halyard or rig a boom preventer. Snub docking lines and mooring ropes. Reduce shock on fishing lines, too. Line Snubbers will secure a dinghy in place or keep one steady while being towed. Protect your lines, cleats, boat components and surfaces from wear with Line Snubber.

#1468 Line Snubber 22, PAIR

011698 00651 9

# LED MEGA LIGHT™

ENERGY EFFICIENT LIGHTING

**NEVER WORRY ABOUT POWER CONSUMPTION AGAIN!**

Campers, fishermen and boaters all face the same challenge when nighttime comes: limited battery capacity for general lighting. LEDs developed in recent years provide a solution. Mega-Light uses an energy efficient LED bulb and high output circuit board design. On a fully charged gear battery, Mega-Light could run continuously for 2000 hours or more. Your battery will hardly know it's there!

**The LED bulb consumes just 23 milliamps—1/50th of an amp!**



**Boating • Fishing • Travel • RVs • Camping**

Both **Mega-Light Utility** and **Mega-Light Masthead** include a light sensor that automatically switches the light on at night and off at dawn. Both models feature a dual-function Fresnel lens that projects light for up to two nautical miles (3.7 km). Hung upside down, the clear top of the lens provides area lighting in the cockpit or around the campsite.

Both **Mega-Lights** come with two easy-to-change light bulbs. A bayonet-type LED draws 23 milliamps and can be seen for up to two nautical miles. The other bulb, incandescent, is more than twice as bright. It draws 320 milliamps (0.32 amp). 100% waterproof O-ring seal.

**#3300 Mega-Light Utility**

011698 33000 3

**#3310 Mega-Light Masthead**

011698 33100 0

**#3330L Replacement Bulbs for all Mega-Lights.**

LED bulb draws less than 23 milliamps (1/50 amp). Lasts up to 10,000 hours. #1893 incandescent bulb provides "soft" lighting; draws 320 milliamps (0.32 amp).

011698 33300 4

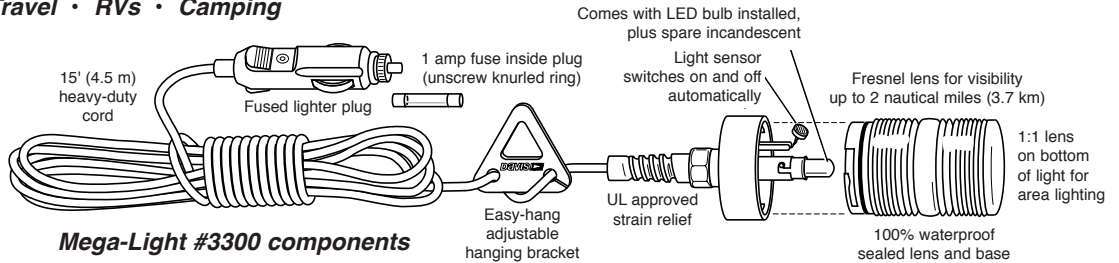

**Mega-Light #3300 components**

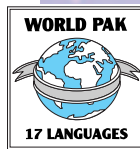

**Mega-Light Masthead** comes mounted to a stainless bracket for easy installation to a masthead, interior wall or bulkhead. Use as a masthead light to mark your moored or anchored boat. As a nighttime security light, it's ideal for stairways and entryways. Stainless steel bracket with six #10 holes and two key-way slots provides multiple installation options. Includes mounting hole for use with Davis Windex® wind indicators. Comes with 12" (30 cm) lead wire. On-off switch and fuse holder for hard-wire installation not included.

**SOLICHARGER-SP™**



**Solar charger, high output speakers, rugged carrying case—all in one!**

- Charges any iPhone®, GoPro®, tablet, MP3 player, cell phone, digital camera
- Rich sound from your mobile devices or laptop

Take along stored energy to recharge your cell phone or portable device on the go! You can charge the 2000 mAh internal battery from the sun, from a PC, or by plugging into any type of USB port. SoliCharger's tough Cordura® case also provides protective storage for devices like a Playstation, camera or cell phone. Use the powerful 3-watt stereo speakers to listen to music, enhance games, or make a hands-free conference call. Output rate is 300–500 mA, and you can use your phone or device while it is charging. LED charge indicator tells you how much charge is available.

Includes adapters for USB, USB Mini, USB Micro, and USB female for all iPhones 5 and above.

**#3480 SoliCharger-SP with speakers**

011698 01093 6

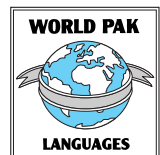

# FSR™ FIBERGLASS STAIN REMOVER

**THE BEST THERE IS!**

**Available in two convenient sizes**

FSR is a unique stain absorbing gel that serves a variety of purposes both ashore and afloat. It's ideal for removing oil, rust, exhaust, waterline and transom stains, yet it can also be used anywhere else fiberglass stains may crop up—shower stalls, furniture, etc. Use for removing road soil from trailered boats and recreational vehicles. Its non-abrasive quality means that it's safe to use on white painted surfaces as well as on gel-coat. Requires no sanding or compounding. Simply apply with a brush, sponge or cloth. Wait a few minutes and then wipe off or rinse. **USE ON SHOWERS AND SPAS, TOO.**

- Great for exhaust and waterline stains
- Removes rust from stainless steel stanchions and railings
- Excellent for removing "rust bleeders" from hull or deck
- Removes road dirt from RVs and trailer boats
- Removes rust stains from clothing, sail cloth, and other fabrics
- Safe on white painted surfaces



**APPROVED FOR USE BY THE U.S. NAVY**

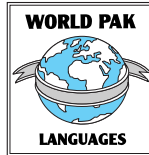

**TIP** Take FSR home to the kitchen to bleach and sanitize wooden cutting boards

**#790 FSR**  
16 fl. oz. • 1 pint  
0.47 liter  
011698 07900 1

**#792 FSR Big Job**  
67.8 fl. oz.  
2.0 liters  
011698 07920 9



Apply, wait a few minutes, rinse or wipe off. Waterline stains gone!

Test a small area first to be sure FSR will not damage finish



Use on stainless steel and enjoy the shine!



Rust stains on fiberglass gone!

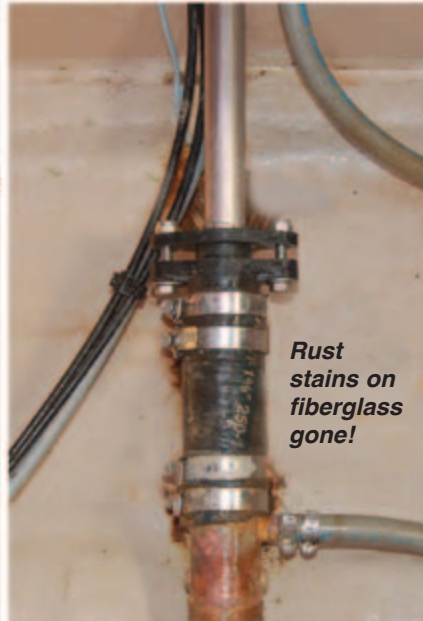

Use on showers and spas—the stain absorbing gel is non-abrasive.



**NEW**

**DAVIS**

# Scrubbis™

## BOAT HULL CARE

*Finally! A marine product that pays you back!*

All boats attract algae, grass, moss, barnacles and worm casings, whether in salt water or fresh. Depending on where you keep your boat, this bottom growth can be aggressive and "set" itself to your boat's hull in a short time.

That's why **Scrubbis** underwater hull cleaning is the boat owner's best friend. Regular maintenance with Scrubbis—typically twice a month, depending on conditions—reverses adverse built-up. Even if you hire a diver to clean your hull, Scrubbis means using that diver fewer times over the season. Just one of the ways Scrubbis pays you back. Your boat is considerably faster and uses less fuel with a clean hull.

More savings are realized as regular light cleaning with Scrubbis removes bottom growth with less paint loss than vigorous scouring. And Scrubbis foam heads with cleaning fins make the job easy. They're buoyant, adding pounds of effortless force to the scrubbing power of each upstroke. Use with Davis FSR stain absorbing gel for an even brighter result. FSR removes waterline stains with very little effort. Apply, wait a few minutes, rinse.



**The Scrubbis system is the easy, effective way to clean your hull and manage its care—while it's still in the water.**



Your boat with a clean hull is up to 30% faster



Fuel savings as much as 20%



Quick and easy—buoyant tools help scrub



No toxic chemicals, 100% recyclable



Motorboats



Sailboats



Salt or Freshwater

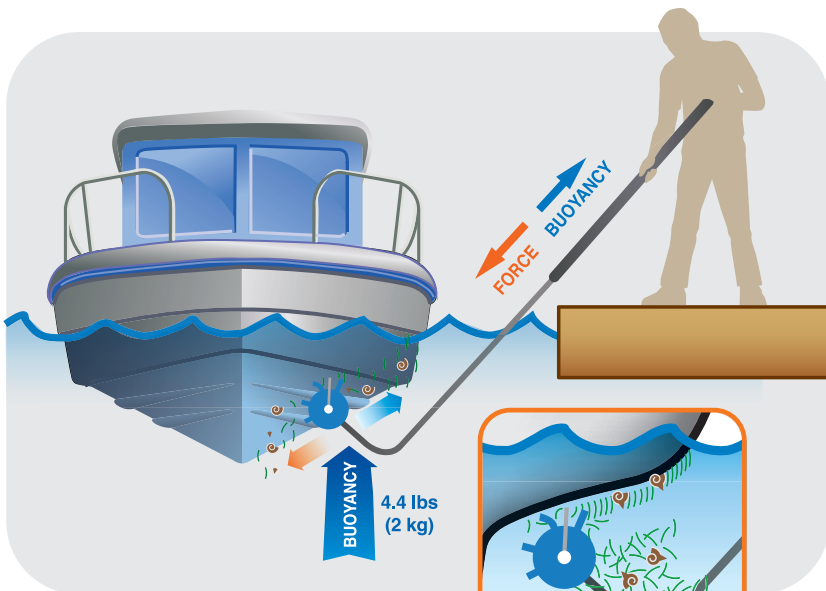

*"Bottom growth, algae and slime are a real drag."  
—Joe Boat*

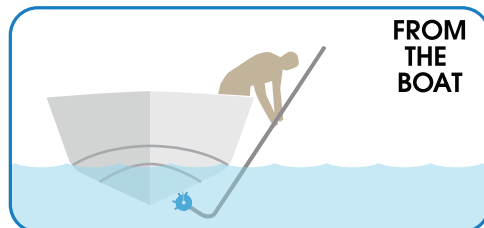

FROM THE BOAT

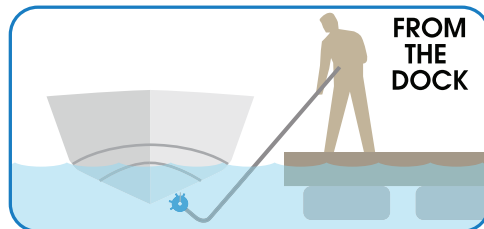

FROM THE DOCK

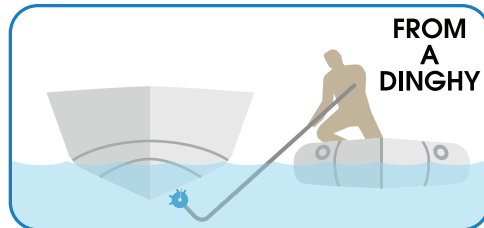

FROM A DINGHY



*Scrubbis—a complete hull care system*

**UNDERWATER HULL CLEANING KIT**

A complete kit for cleaning your boat hull. The buoyant foam head has both stiff and soft cleaning fins and provides 4.4 lbs. of buoyancy (2 kg) to power scrubbing on the upstroke. Head attaches to a curved ergonomic tube. Telescoping pole extends from 43–86 in. (1.1–2.2 m). Use extension pole to provide a total length of 126 in. (3.2 m). Entire kit weighs just 3.2 lbs. (1.5 kg). The clam-shell packaging is recyclable. When the replaceable cleaning head wears out, it can also be recycled.

**#4400 Underwater Hull Cleaning Kit**  
 Buoyant foam head, ergonomic tube, telescoping tube, extension tube.

011698 01347 0

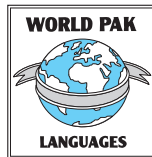

Link to demonstration video



**#4420 GROOVY SCRUBBIS**

For tough underwater fouling. This buoyant head is an add-on accessory for removing more bottom growth. 22 x 7 in. (56 x 18 cm), 1.0 lb. (.45 kg).

011698 01349 4



**#4410 WATERLINE BRUSH**

Provides soft cleaning of stains at the waterline. Quickly attaches to the telescoping pole included with the Hull Cleaning Kit, or buy a Replacement Telescoping Pole dedicated to the purpose. 16 inches long (41 cm), 0.3 lb. (0.14 kg).

011698 01348 7



**#790, 792 FSR FIBERGLASS STAIN REMOVER**

Two sizes. See product details on page 15.



**#R4400A REPLACEMENT HULL CLEANING HEAD**  
 20 x 5 in. (51 x 13 cm), 0.5 lb. (.23 kg).

011698 01350 0

**#R4400B REPLACEMENT TELESCOPING POLE**  
 43 x 1 in. (109 x 2.5 cm), 1.0 lb. (0.45 kg).

011698 01351 7



Attention: It is the user's responsibility to be sure that the use of this product complies with any laws and environmental regulations.

# Quick Fist™

One Piece Rubber Clamp

Securing your equipment just got a whole lot easier!

**Two Sizes Grip Anything**  
from 7/8 to 7 1/2" (22–191 mm)

**Quick Fist** is a rubber clamp that mounts easily to keep tools and equipment firmly in place. Ideal for boats, off-road trucks, military equipment, ATVs, or any vehicle. Quick Fist clamps are made of heavy duty transportation grade rubber. They're UV resistant and withstand extreme heat or cold. Mount easily with #10 (5 mm) bolts or screws. Terrific for marine use—Quick Fist will not rust or corrode. Available in standard or super sizes.



#540

#544



## Quick Fist

Standard **Quick Fist** is ideal for stowing or transporting tools. Can also be used as a pipe stand-off (do not use on exhaust pipes). Mounts easily with one #10 (5 mm) bolt or screw (not included). Can be mounted with strap facing any direction. To clamp, pull strap through jaw and lock into place. Sold in pairs. Multiple Quick Fists can hold larger tools.

- Holds objects from 7/8–2 1/4" in diameter (22–57 mm)
- Each clamp supports approximately 22 lbs. (10 kg)



**#540 Quick Fist Clamp** Package includes 2 clamps  
Mounting base measures 7/8 x 2 3/4" (22 x 70 mm)

011698 00821 6

## SUPER Quick Fist

**Super Quick Fist** is ideal for holding fire extinguishers, oxygen cylinders, CO<sub>2</sub> tanks, and other equipment. Mounts easily with three #10 (5 mm) bolts or screws (not included). Can be mounted with strap facing any direction. To clamp, pull strap through jaw and lock into place. Strap can be trimmed off for neat installation.



- Holds objects from 2 1/2–7 1/2" in diameter (64–191 mm)
- Each clamp supports approximately 50 lbs. (23 kg)

**#544 Super Quick Fist Clamp**  
1 clamp  
Mounting base measures 7/8 x 6" (22 x 152 mm)

011698 00822 3

## tiller-tamer™ Like having an extra crew member!

TILLER STABILIZER & LOCK



**Tiller-Tamer** maintains cruising course with no hands, in any weather or wind conditions. The tension is smoothly adjustable from fully locked to fully free. Tiller-Tamer gives improved control and feel to the tiller handle. Does not interfere with automatic steering systems. No loss of cockpit space. No need to lash the tiller when boat is moored or trailered. Equally adaptable to inboard rudder tillers, too!

**#2205 Tiller-Tamer**

011698 22050 2

## CABLE COVERS

Protect sails and sheets from chafe

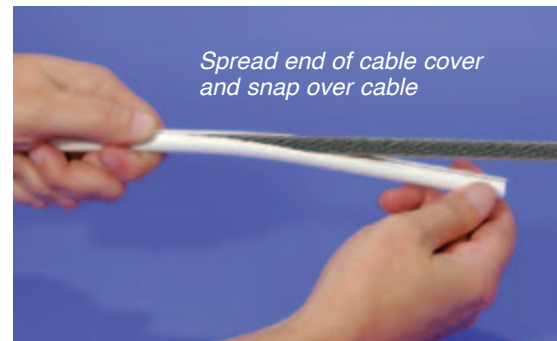

Spread end of cable cover and snap over cable

- Keep sails clean, prevent wear
- Slit along covers for quick "snap-on"
- Tough, durable plastic with more ultraviolet absorber than other brands—last longer!

### CABLE COVERS

Product No.	Fits Cable Size	Cable Cover Length
<b>252</b> 011698 02520 6	1/8" (3 mm)	6 ft. (180 cm)
<b>253</b> 011698 02530 5	5/32" (4 mm)	6 ft. (180 cm)
<b>254</b> 011698 02540 4	3/16" (5 mm)	6 ft. (180 cm)
<b>255</b> 011698 02550 3	1/4" (6 mm)	6 ft. (180 cm)
<b>256</b> 011698 02560 2	5/16" (8 mm)	6 ft. (180 cm)
<b>257</b> 011698 02570 1	3/8" (10 mm)	6 ft. (180 cm)

# SNAP TOOL • MULTI-KEY

**HANDY • UNIVERSAL • STAINLESS STEEL • STRONG**

A pocket-sized tool perfect for all outdoor activities, including boating. This deck plate key with an attitude is a serious tool for serious use outdoors:

*Fishing Climbing Biking Sailing Hiking Boating Camping Tailgating RV*

**19 tools in one!** The button snap and zipper pull features make working with canvas a "snap" instead of a chore. And this is a deck plate key that fits most deck plate caps. It's also a pocket-sized hex wrench and screwdriver with both slot and Phillips heads. The cutting blade is designed to cut fishing line and small cord—and the shackle key works on stainless or galvanized pin shackles. Made of corrosion resistant stainless steel, it's both thicker and stronger than other inexpensive deck keys—all at an affordable price. At five o'clock this new Snap Tool Multi-Key is ready to become your best friend!

**#382 Snap Tool • Multi-Key**

2.75 x 4.48" (7.0 x 11.4 cm)  
Unit weight 2.8 oz. (80 g) 011698 01271 8

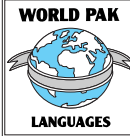

**NEW FEATURES**

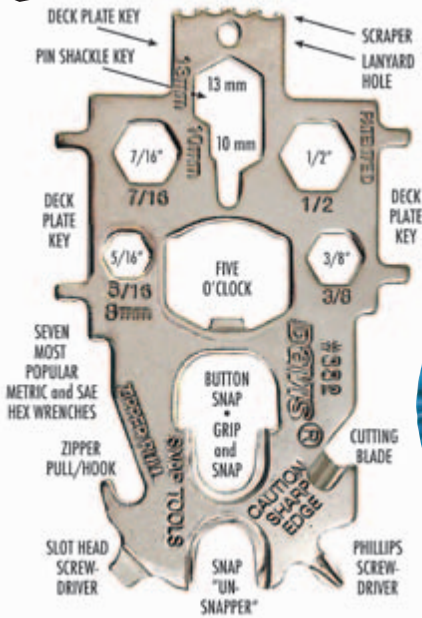

- 7 hex wrenches
- 3 deck plate keys
- 2 screwdrivers
- 2 button snap tools
- 1 scraper
- 1 cutting edge
- 1 zipper pull
- 1 shackle tool
- 1 bottle opener

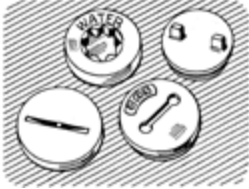

Canvas shrinks, button snaps corrode—no problem!

**PATENTED**



Weathered zippers are hard to pull—not anymore!

**TIP** Attach a Key Buoy self-inflating key ring #530 to the Snap Tool • Multi-Key to avoid losing your favorite tool in the water!

Constructed of specially hardened stainless steel. **Will not corrode or break...ever!**



Hook used to pull ring



Screwdriver



Shackle key

<p><b>Deck Plate Key</b> Fits most caps: water, fuel, waste</p>	<p><b>Un-Snap Canvas Snaps</b> Handling button snaps made easy, especially on shrunken canvas or corroded snaps</p>	<p><b>Snap Canvas Snaps</b></p>	<p><b>Zipper Puller</b> Tames stiff, sticky or oxidized zippers</p>	<p><b>Cutting Tool</b> Fishing line, paracord, webbing, cardboard boxes, emergency use</p>
<p><b>Hex Wrench</b> Popular sizes: 5/16, 3/8, 7/16, and 1/2 inch—plus 8 mm, 10 mm and 13 mm</p>	<p><b>Screwdrivers</b> Both Phillips and slot</p>	<p><b>Scraper</b> Removes labels, tape, dry paint</p>	<p><b>Pin Shackle Key</b> Tightens or loosens pins on most galvanized anchor shackles and stainless steel pin shackles</p>	<p><b>Bottle Opener</b> Enough said!</p>

# SELF-INFLATING KEY BUOY™

Never Lose Keys in  
the Water Again!



PATENTED

- When keys fall in the water, Key Buoy inflates to 14" (36 cm)
- Tube carries keys to the surface for easy retrieval
- Stays afloat for over an hour
- Suitable for items weighing up to 2.8 oz. (80 g) such as key sets and small tools
- A great gift!

Key Buoy is for single use only. Activator is sodium bicarbonate and tartaric acid, a mild irritant. Not a toy. Prevent contact with eyes and skin; avoid inhalation. Activated product should be promptly disposed.

#530  
KEY BUOY  
self-inflating  
key ring

011698 00877 3



## QUEAZ-AWAY™ TRAVELERS' WRISTBANDS

Fight the  
unpleasant  
effects of  
travel!

Queaz-Away is a non-drug aid that relieves the unpleasant effects of bumpy flights, choppy seas, winding roads, rocking trains, and spinning Ferris wheels. Queaz-Away wristbands exert gentle pressure on points on each wrist to minimize or eliminate the miserable effects



The "Tummy Tamer"



of nausea. Made of tough, long-lasting, washable materials. Safe and easy to use. Simply slip onto wrists, position, and enjoy your trip or outing. One size fits all! Handy carrying case included. Used throughout the world by yachtsmen, pilots, divers, physicians and hospitals.

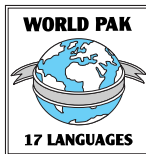

#400  
Queaz-Away,  
PAIR

011698 04000 1

## TURBO METER™

ELECTRONIC WIND SPEED INDICATOR

Measures Wind Speed from 0–99.9 MPH (0–44.8 meters/sec)  
Accurate to ±3% of Reading

- Responds to Lightest Winds
- Four Scales
- Easy to Read Day or Night
- Weather and Shock Resistant

The rotation of Turbo Meter's freely turning turbine, suspended on sapphire jewel bearings, is sensed by an infrared light beam. The resulting signal is processed electronically. The display has been made larger, brighter for excellent viewing in full sun or dark conditions. Auto Power-Off. Compact size (2.6 × 4.7 × 1.2", 7 × 12 × 3 cm) and lightweight (3 oz., 85 g). Wrist lanyard, protective case included.



SCALE	RANGE	RESOLUTION	THRESHOLD
Knots	0–87.9	0.1 Knot	0.9 Knot
Feet Per Minute	0–8790	10 FPM	90 FPM
Meters Per Sec.	0–44.8	0.1 m/s	0.5 m/s
Miles Per Hour	0–99.9	0.1 MPH	1 MPH

NIST

AVAILABLE

For intermittent use only above 12 MPH (1000 FPM).  
Requires 3 AAA alkaline batteries (not included).  
Redesigned for even longer battery life.

#271 TURBO METER

011698 02710 1

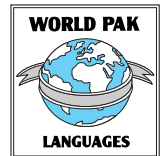

Turbo Meter is useful in many fields:

- Yachting • Boating • Windsurfing • Aviation • Sky Diving • Hang Gliding
- Hot Air Ballooning • Track & Field Events • Skiing • Mountaineering
- Archery • Shooting • Model Flying and Sailing • Kite Flying
- Meteorology • Air Flow Testing • Crop Dusting • Ventilation
- Wind Sensitive Construction and Spraying • Anywhere wind is a factor

## SAIL TRACK STOPS



When it's time to lower your sail, you can rely on Davis' SAIL TRACK STOPS to hold your sail and its slides in place on the mast and boom. Large knurled wheels are released with ease. Made of heavy-duty, black anodized aluminum and marine grade nickel plated brass. Flat stops come with lanyard holes.

#2350 ROUND .50" dia. × .875" (13 × 22 mm)  
011698 23500 1

#2351 FLAT .42 × 1 × .125" (11 × 25 × 3 mm)  
011698 23510 0

#2352 FLAT .75 × 1 × .125" (19 × 25 × 3 mm)  
011698 23520 9

# Air-Dryr™

**Say Goodbye to Mold, Mildew and Moisture**

**Air-Dryr** is a silent, inexpensive and effective way to combat moisture, cold drafts and corrosion. Designed to operate anywhere continuously 24 hours a day—just plug it into any 110/120 volt outlet and leave it on. It works best when placed low on the floor of any damp, enclosed space allowing Air-Dryr to draw in cool, moist air. The damp air is gently heated to the point where moisture is held in suspension (above the dew point), then released through the top vents of the device. As warm air rises, more damp air is drawn into the unit, where it too is heated. The resulting natural convection circulates the air and prevents moisture from settling. In a perfect situation, ventilation will remove the moisture laden air, replacing it with drier air.

Air-Dryr fights humidity with a different and simpler approach than dehumidifiers or chemicals that sometimes empty liquids into a sink (or onto the floor when spilled!). Silent, energy efficient operation costs no more to use than a single incandescent light bulb. Designed with a thermal cut-off switch to turn Air-Dryr off if air flow is impeded.

No switches or thermostats to set. Just plug it in and enjoy the results.



**Air-Dryr 1000**

**Air-Dryr 500**



**Use at Home or Office** Basements, closets, under desks, storage units, tack rooms, pump rooms, gun cabinets, pianos



**Use in RVs and Airplanes** Motor homes, trailers, cars, aircraft



**Use in Boats** Cabins, bilges, engine rooms, V-berths

**Features of both Air-Dryr models:**

- Attractive, neutral beige housing made of polycarbonate for strength and durability
- Slim and stable; can be placed out of the way in confined spaces
- Handle a high volume of air
- Low operating cost; designed to be left on 24 hours a day
- Silent in operation, safe to the touch
- Trouble free—no switch, fan, or thermostat
- Safe for marine use—no components which cause sparking
- Air-Dryr is equipped with a THERMAL CUTOFF to prevent overheating due to blocked vent holes, but continued caution is advised.



**CAUTION:** To prevent fire or damage to the unit, do not block vent holes. Keep out of water to avoid electrical shock. Do not touch hot surfaces. Unplug and allow the unit to cool before cleaning or storing. Do not place on or near a hot gas or electric burner, or in an oven.

**Two models**



**#1459 Air-Dryr 500** Handles up to 500 cubic feet of living space (14.2 cubic meters). Draws only 0.6 amps, 70 watts. Rectangular unit measures 13.5 x 5.5 x 4.25" high (34 x 14 x 11 cm high).

011698 00643 4

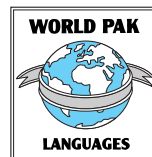

**#1458 Air-Dryr 1000** Handles up to 1000 cubic feet of living space (28.3 cubic meters). Draws only 1.1 amps, 130 watts. Circular unit measures 13.5" in diameter, 4.25" high (34 cm dia., 11 cm high).

011698 00642 7

# DAVIS ECHOMASTER™

**Ranked One of the World's Best Radar Reflectors!**

Giving ships a chance to see you in fog and low visibility conditions is a must for serious boaters.

Echomaster's full 12.5" (32 cm) diameter circular reflector plates provide 13.2 square yards (12 sq. meters) of maximum effective radar cross section in the X or 3 cm band (9–9.6 GHz frequency), based on optimum orientation between the reflector and radar. Offers equivalent radar cross section of a conventional triangular plate reflector with approximate 17" (43 cm) diagonal dimension.

Robust, marine-grade aluminum plates are sufficient thickness to minimize flexing; dimpled to minimize angular distortion. Tough injection-molded, captive corner latches assure minimum angle error. The 1 1/4" (32 mm) windage holes reduce aerodynamic drag and allow assembly of the reflector around a backstay. Easily assembled or demounted. Stows flat.

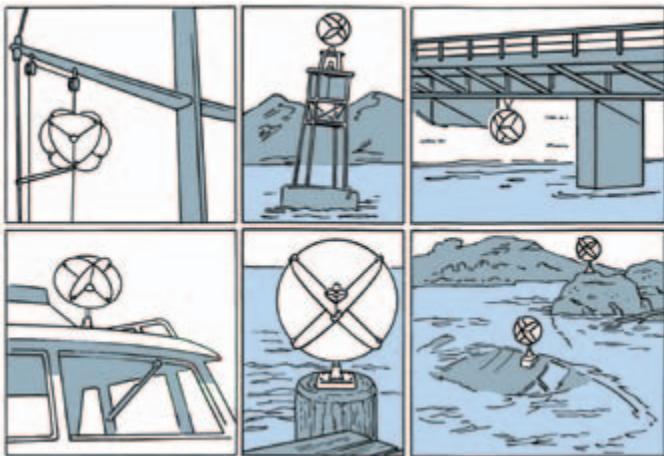

**Make your boat visible** to other vessels.

**Find your way home** in less than perfect conditions. Mount a radar reflector on a buoy or piling to help identify your dock or mooring.

**Mark hazards to navigation** to supplement official channel markings. Install radar reflectors on specific hazards—bridges, rocks, submerged trees, sunken boats.

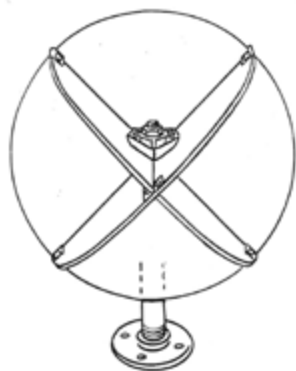

To **SURFACE MOUNT** an Echomaster, use the corner blocks from the #156 Hanging Mount System with five pipe fittings commonly found in hardware stores.

To order the Radar Reflector Booklet separately, contact customer service and ask for #R155E (\$3.00).

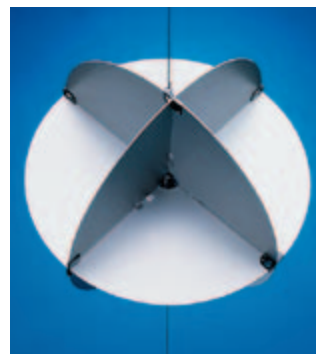
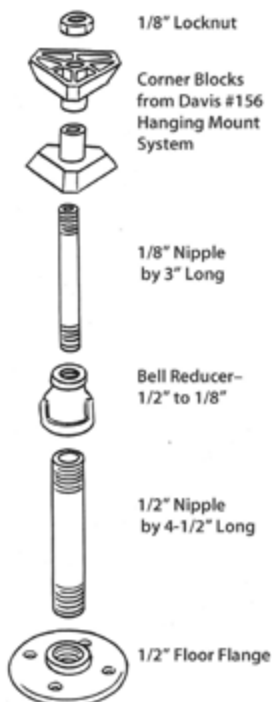

*Echomaster meets U.S. Coast Guard requirements for lifeboat and liferaft radar reflectors under SOLAS 74/83.*

## ECHOMASTER with Marine-Grade Aluminum Plates

12 square meters of radar cross section. Plates are made of sturdy, stamped 1.3 mm thick aluminum with riveted nylon corner latches for quick assembly or disassembly. Install around a backstay using corner blocks from #156 Mount System, or make your own hanging bridle as described in the 16-page Radar Reflector Booklet included with Echomaster.

**#152** 011698 01520 7

## HANGING MOUNT SYSTEM (no reflector)

Use the hanging mount system to suspend your Echomaster unit from a mast or rigging in the perfect "catch rain" position.

**#156** 011698 01560 3

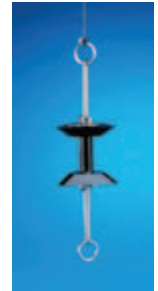

**Echomaster's proven superiority:**

- Ranked one of the best radar reflectors and one of the top ten sailing products by *Practical Sailor*.
- Rated "superior" by SRI after the most rigorous tests ever conducted on radar reflectors, some costing 10 times as much.
- Performance diagrams from the Admiralty weapons test, England, showed Echomaster's high response to incoming radar at all angles:



DAVIS ECHOMASTER #152

DAVIS EMERGENCY RADAR REFLECTOR #151

MOBRI RADAR REFLECTOR

FIRDELL BLIPPER

RADAR FLAG

*Strong peaks, narrow valleys, and 360° returns are desirable.*

## EMERGENCY RADAR REFLECTOR

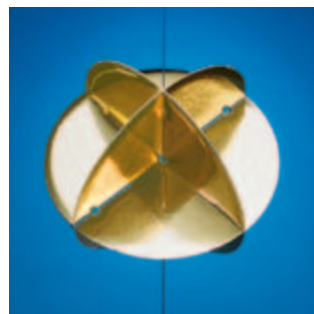

Excellent as a back-up aboard larger vessels or primary reflector on smaller boats that might not normally carry a radar reflector. Made of plastic-metal foil laminate. Opens in seconds and is very lightweight. 11.5" (29 cm) in diameter. Performs almost as well as Echomaster (see performance diagrams above). Economical enough for any boat. Stows flat.

**Recommended "Best Buy" by Practical Sailor!**

**#151  
Emergency Radar Reflector**

011698 01510 8

# Vantage Vue®: All-in-one weather station

Vantage Vue provides accurate, reliable weather monitoring in a self-contained, easy-to-install system. Sleek but tough, Vantage Vue gives you all the weather data you need.

- Inside & Outside Temperature
- Inside & Outside Humidity
- Barometric Pressure
- Wind Speed & Direction
- Dew Point
- Rainfall

Your outdoor Sensor Suite sets up in minutes and transmits data wirelessly to your console anywhere in your home, school, or business. In addition to displaying current weather conditions and trends, Vantage Vue also gives you the ability to view up to 50 different graphs and displays weather variables over the last 25 days.

## 6250 Vantage Vue

### Features:

- Up to 10× faster updates than the competition (every 2.5 seconds).
- Wireless transmission 3× farther than the competition (1,000 ft./ 300 m from station to console).
- Easy-to-read backlit screen.
- Glow-in-the dark keypad.



The Sensor Suite mounts on poles from 1.00" to 1.75" (2,54 cm to 4,45 cm) in diameter (pole not included).

#### 1. WIRELESS

Frequency-hopping spread-spectrum radio ensures consistent transmission up to 1,000 ft. (300 m) line-of-sight from Sensor Suite to console.

#### 2. RAIN COLLECTOR

Self-emptying tipping spoon measures rain in 0.01" increments. Metric version measures in 0,2 mm increments.

#### 3. ANEMOMETER

Wind tunnel-tested to 200 mph (320 km/h).

#### 4. WEATHER-PROOF HOUSING

Corrosion-resistant cover

provides durability in extreme conditions. Electronics are potted and overmolded for added moisture shielding.

#### 5. RADIATION SHIELD

Provides excellent protection from solar radiation and other sources of radiated and reflected heat for accurate temperature and humidity readings.

#### 6. TEMPERATURE & RELATIVE HUMIDITY

Provides outside temperature reading from -40° F to 150° F (-40° C to 65° C) and measures relative humidity from 1 to 100%.

#### 7. EASY INSTALLATION

Installs easily and quickly with included mounting hardware kit.

#### 8. WIND DIRECTION

Measures wind direction in compass points or degrees.

#### 9. SOLAR PANEL

Energizes the station during the day. Onboard supercapacitor provides power at night. Lithium battery provides backup when needed.

#### 10. BUILT-IN BUBBLE LEVEL

Allows for more accurate installation and better data collection.

#### 1. TIME & DATE

View the current time and date, or time of sunrise/sunset.

#### 2. MOON PHASE

Track the eight phases of the moon.

#### 3. FORECAST

Icons let you know to expect sun, partly cloudy, clouds, rain, or snow.

#### 4. TEMPERATURE & HUMIDITY

Console updates outside temperature every 10 seconds and inside temperature every minute. In addition, outside humidity updates every 50 seconds and inside humidity every minute.

#### 5. BAROMETER

Five-position trend arrow shows whether barometric pressure is rising, falling, or stable.

#### 6. VARIABLE DISPLAY OPTIONS

See heat index and wind chill to get a better "feel" for the outside environment.

#### 7. RAIN

Console updates rain every 20 seconds.

#### 8. USER-FRIENDLY KEYPAD

Domed buttons are easy to feel and press. Glow-in-the-dark keypad buttons give you access to weather information at night.

#### 9. GRAPHS

Graph the last 25 hours, days, or months. View up to 50 different graphs.

#### 10. ALARMS

Set 22 simultaneous, different alarms to warn of dangers such as high winds, freezing temperatures, rain rate, heat index, flood warning, and more.

#### 11. WIND SPRED

See wind speed updates every 2.5 seconds. Displays wind speed in miles per hour, meters per second, kilometers per hour, or knots. Provides the average and high wind speed for 2-minute and 10-minute intervals.



Pair with a data collection product (page 25) to access data anywhere, anytime, and on any device with the WeatherLink Cloud.



# Vantage Pro2™: Professional and rugged

Vantage Pro2 and Vantage Pro2 Plus offer the professional weather observer or serious weather enthusiast robust performance with a wide range of options and sensors. You'll get your own local forecast, highs/lows, totals or averages, and graphs for virtually all weather variables over the past 24 days, months or years—all on the console.

Vantage Pro2 uses frequency-hopping, spread-spectrum radio to transmit and receive data up to 1,000 ft. (300 m) line-of-sight. Vantage Pro2 is also an excellent choice for emergency professionals, farmers, educators, researchers, municipalities, and others to monitor wind and moisture conditions, irrigation requirements, and potential flooding.

**6152 Vantage Pro2 Station, wireless**

**6163 Vantage Pro2 Plus Station, wireless** (pictured)

See all available models: [www.davisinstruments.com/solution/vantage-pro2](http://www.davisinstruments.com/solution/vantage-pro2)

## Features:

- Up to 10× faster updates than the competition (every 2.5 seconds).
- Wireless transmission 3× farther than the competition (1,000 ft./300 m from station to console).
- UV/solar radiation and evapotranspiration updates (included with Vantage Pro2 Plus, optional for Vantage Pro2).
- Large, backlit 3.5" × 6" LCD screen (9 × 15 cm).

### 1. ANEMOMETER

Includes both wind speed and wind direction sensors. Rugged components stand up to hurricane-force winds, yet are sensitive to the lightest breeze. Wind-tunnel tested to 200 mph (320 km/h).

Anemometer can be installed separately using 40 ft. (12 m) cable, included.

### 2. RAIN COLLECTOR

The AeroCone Rain Collector meets the collection area guidelines of the World Meteorological Organization. Reads rainfall amounts in 0.01" increments. Metric versions measure in 0,2 mm increments.

### 3. PASSIVE RADIATION SHIELD

The most effective passive shelter available. Protects your Temperature/Humidity Sensor from solar radiation and other sources of radiated and reflected heat. Multi-plate construction for maximum airflow.

### 4. 24-HOUR FAN-ASPIRATED RADIATION SHIELD

Models with 24-Hour Fan-Aspirated Radiation Shields include additional radiation shield plates and a second solar panel to power the motor-driven fan.

### 5. TEMPERATURE & HUMIDITY SENSORS

Located inside the radiation shield, which protects the sensors from solar radiation and other sources of radiated and reflected heat.

### 6. SOLAR PANEL

Powers the wireless station during the day and charges the supercapacitor for night operation. Lithium battery provides backup on cloudy days.

### 7. WEATHER-RESISTANT SHELTER

Provides protection against the elements for the Sensor Suite's electronic components.

### 8. SOLAR RADIATION AND UV SENSORS (Vantage Pro2 Plus)

Includes sensors to track solar radiation, evapotranspiration and UV indices.



**6163 Wireless Vantage Pro2 Plus** »  
with 24-hour Fan-Aspirated  
Radiation Shield (pole not included).

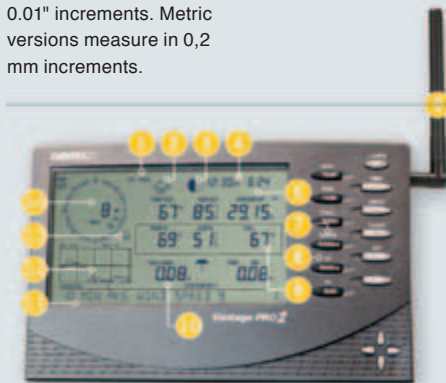

### 1. CURRENT & HISTORICAL DATA

View the current or highs and lows for up to 24 days, months, or years.

### 2. FORECAST

Icons let you know what to expect: sun, partly cloudy, rain, or snow.

### 3. MOON PHASE

Track the eight phases of the moon.

### 4. TIME & DATE

View the current time and date, time of sunrise/sunset, and time and date of highs/lows.

### 5. WIRELESS

Frequency-hopping spread-spectrum radio provides three times the transmission distance of the competition.

### 6. BAROMETER

Know whether barometric pressure is rising, falling, or steady.

### 7. SOLAR RADIATION

Included on Vantage Pro2 Plus. View solar radiation, highs for the day, month, and year, as well as evapotranspiration and Tem/Hum/Sun/Wind (THSW) index. Set alarms for high readings.

### 8. UV

Included on Vantage Pro2 Plus. View current UV index, UV index for the day; the daily, monthly, and yearly highs.

### 9. VARIABLE DISPLAY OPTIONS

View inside or additional temperatures, humidity, soil moisture, UV index, leaf wetness, wind chill, dew point, and two different heat indices. (Additional sensors or stations may be required).

### 10. RAIN

View last 24 storm totals with start and end dates. View daily, monthly, or yearly rainfall and rain rate.

### 11. TICKER-TAPE DISPLAY

Provides expanded forecast details.

### 12. GRAPHS

Graph the last 24 hours, days, or months of readings; or highs and lows. View over 80 graphs.

### 13. ALARMS

Set more than 70 alarms for multiple functions simultaneously.

### 14. WIND

Compass rose with 16 points shows current and dominant wind direction.



Pair with a data collection product (page 25) to access data anywhere, anytime, and on any device with the WeatherLink Cloud.



# Use the data collection device that's right for you



WeatherLink Live



WeatherLink USB



WeatherLink Serial



Vantage Connect

	WeatherLink Live	WeatherLink USB	WeatherLink Serial	Vantage Connect
Data transmission	Wi-Fi/Ethernet	USB	Serial	Cellular
Data upload to WeatherLink Cloud requires computer and software running 24/7	No	Yes	Yes	No
Streams live data within LAN	Yes	No	No	No
Typical installation location*	Indoor	Indoor	Indoor	Outdoor
Console or Weather Envoy required	No	Yes	Yes	No
Storage capacity**	180 days	26 days	26 days	26 days
Power source	AC/battery back-up	AC/battery via Console/Weather Envoy	AC/battery via Console/Weather Envoy	Solar/battery back-up
Annual service plan required	No	No	No	Yes
Product number	6100	6510USB	6510SER	6621, 6621C

\* Data loggers noted as indoor can be installed in a Solar Power Kit for use outdoors.  
 \*\* Based on data from one Sensor Suite at a 15-minute archive interval.

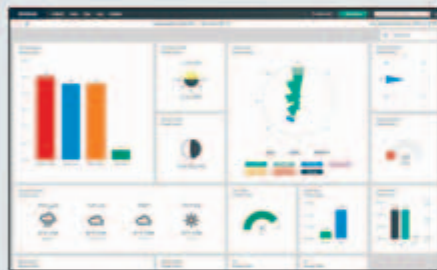

Build a custom weather view on the bulletin dashboard.

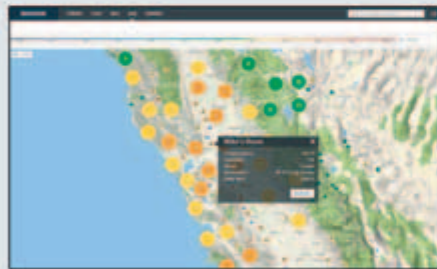

View current conditions bulletin dashboards from the global WeatherLink Network of public stations.



Use the chart feature to compare multiple weather data variables at the same time with Pro Upgrade.

## WeatherLink.com: All of your data, on the web

### WeatherLink Basic **FREE**

With the completely FREE WeatherLink Basic account you get a versatile tool to monitor current conditions at home or around the world.

- Create a custom bulletin dashboard of current conditions with 16+ different data types.
- Share a secure station URL for anyone to view your weather data. No account required to view.
- View local weather forecasts.
- Access the global WeatherLink Network of public stations on the map.
- Upload data to third-party sites, like Weather Underground, Globe, and CWOP.
- Get e-mails and text alerts with preset alarms.
- Use the API to access weather data in XML or JSON formats.

### WeatherLink Pro **\$3.95/month/device**

Enhance your WeatherLink experience by upgrading a weather station to Pro.

- Visualize multiple data points at once with historical data in charts.
- Analyze and download all raw data records.
- Increase data speeds for third-party uploads and API usage.
- Pro share a station to give Pro capabilities to up to six friends or colleagues.
- Use Mobilize web and mobile tools for smart farming and gardening.



## WeatherLink App **FREE**

View your current and forecast conditions from your station and the WeatherLink Network of public stations around the world, all from a mobile phone or tablet.

Search "Davis WeatherLink" on iOS and Android app stores.



WeatherLink  
iPhone app

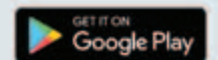

WeatherLink  
Android app



### Tough • Versatile • Sensitive

**Black Max** is a versatile, high performance wind direction indicator that attaches quickly to masts and booms on most small boats such as Lasers and Sunfish. The tough, high impact plastic vane is designed to withstand years of punishment and the abuse of small boat sailing. The stainless steel mounting arm and set screw, as well as a tough plastic mounting base, add to the system's durability. Wind vane length 8" (20 cm).

**#1295 Black Max**

011698 12950 8

Unique adjusting system fits masts or booms from 1.5 to 2.5" (38 to 64 mm)

**Extra Vane**

**#1452**

011698 14520 1

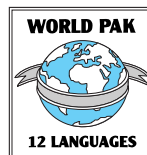

Black Max comes in its own *unbreakable* protective storage tube.



Black Max™ attached to a boom

## TELO-CAT™



A must for your Catamaran!

Designed especially for catamarans, the Davis **Telo-Cat** is durable and highly visible. Installs on the headstay bridle in seconds; easily removed for trailering (no tools required). Comes complete with high visibility 8" (20 cm) vane, adjustable tacking arms, and mounting hardware to fit most catamarans. Made of high impact plastic with a stainless steel shaft and tacking arms. The vane rides on a super sensitive nylon bearing system for extreme accuracy in light or heavy weather. Highly visible markings. Adjustable reference arms. Telo-Cat can take the abuse of catamaran sailing.

Wind vane length 8" (20 cm).  
Weight 2.9 oz (82 g).

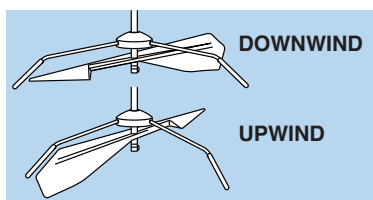

DOWNWIND

UPWIND

**#1450 Telo-Cat**

011698 14500 3

**#1452 Extra Vane**

011698 14520 1

Telo-Cat includes complete mounting instructions for the following catamarans: • Hobie 14, 16 • Supercat 15, 17 • Prindle models with turnbuckle forestay adjuster • NACRA 5.2 Telo-Cat will also fit other catamarans using forestay fittings similar to models above.

## RIGGING KNIFE

*High Quality, Sensibly Priced*

The Davis Deluxe Rigging Knife is made entirely of top quality stainless steel, with dura-edged blade. This tool features a marlin spike, slot head screwdriver, shackle key and a stainless steel loop to attach a lanyard. This is a sturdy, quality knife that a yachtsman will be proud to own—at an affordable, go-to price.

**GREAT FOR:**

- Sailors, powerboaters, fishermen
- A keep-aboard spare
- Emergency ditch bag
- Untying stubborn knots
- Loosening stainless and galvanized anchor shackles
- A unique gift

**#1551 Deluxe Rigging Knife**

- Marlin Spike
- Screwdriver
- Shackle Key

011698 15510 1



On top all over  
the world

# WINDEX® *The Standard on Mastheads around the World*

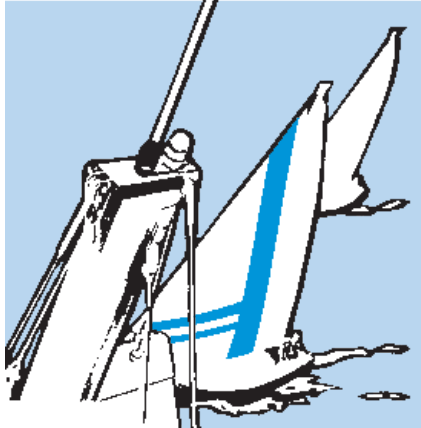

WINDEX wind vanes are well-suited for boats from 15–100 feet and above (4.6 to 30 meters). Every Windex features a sapphire jewel suspension bearing, vane with a large fin and low inertia, and an easy-to-read, fully adjustable tacking tab system. Reflector tape on the vane and tabs makes Windex highly visible in low levels of light—easy to see at night.

Windex vanes are sturdy and durable, wind-tunnel tested to wind speeds of 80 knots! Installed properly, they offer many years of hassle-free use. Windex is the sailing industry standard.

All sailors appreciate the accurate sensitivity, time-tested durability, and best value that Windex provides. Next time you're on the water, look up and see what most sailors choose....Windex!



- Sapphire jewel suspension bearing
- Large fin, low inertia vane molded of highly UV resistant plastic
- Adjustable tacking tabs
- Clearly visible reflectors on the tacking tabs and vane
- Optional LED Windex Light (#3200)
- Windex 15 includes bird-proof spike

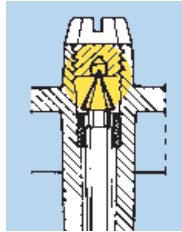

*The sapphire suspension bearing allows Windex to seek wind direction even in winds less than one knot*

No other wind vane in the world is as sensitive to super light air and small puffs—or as responsive when the breeze picks up.



10" wind vane  
#3120

## WINDEX® 10 -SPORT

*For Small Boats and Dinghies*

Sapphire suspension bearing, 10" vane (25 cm) and adjustable tacking arms with tabs. Vane and tabs feature reflectors for high visibility day and night. Includes glass reinforced polycarbonate J-Base for side, top or front of mast mounting on most dinghies, smaller boats and sport boats. Stands just 9.25" (23.5 cm) tall and weighs 1.2 ounces (31 g).

*Windex 10.Sport's J-Base allows mounting on side, top, or front of mast.*



#3120 Windex 10.Sport  
011698 00193 4

#3101 Spare Vane only  
011698 31010 4

## WINDEX® 15

*The Choice for Most Sailors*

Sapphire suspension bearing, 15" vane (38 cm) and adjustable tacking arms with tabs. Vane and tabs feature reflectors for high visibility day and night. Through-bolt or drill & tap mounting socket; 5/16"-18 stainless stud, washers and nut included. Windex 15 weighs just 3.9 ounces (111 g). Stands 12.75" (32 cm) tall. Bird-proof spike extends above vane to keep birds off your mast. Optional Windex Light #3200.

**TIP** Sailors concerned with weight aloft can shorten the bird-proof spike.

*The J-Base can be purchased separately for Windex 15 (#3155).*



#3150 Windex 15  
011698 31500 0

#3151 Spare Vane only  
011698 31510 9



15" wind vane  
#3150

*With Bird-Proof Spike*



## WINDEX AV

For Mounting to Most Whip Antennas



Windex AV™ installs onto most whip antennas, including Metz™ and Shakespeare™ brands, with a whip diameter less than 1/8" (3 mm). Combine two installations into one to reduce masthead clutter, weight and windage aloft. Rides on low-friction Teflon™ bearings. Complete with 15" (38 cm) vane, reflective tacking arms, hardware and instructions for easy installation. Antenna not included.

#3160 Windex AV

011698 31600 7

#3161 Spare Vane only

011698 31610 6



## WINDEX LIGHT

For Viewing Windex Indicators at Night



Light up the reflector tabs and vane on your Windex for easy viewing at night with LED Windex Light. Waterproof and non-corroding silver parts give long-life light at less than 100 ma current draw. Fits under Windex 15, Windex 10 or J-Base™ mounting socket.

#3200 Windex Light/LED

011698 32000 4

#R3201L Replacement LED Bulb

011698 00000 0

#R3200B Replacement Dome Lens

011698 00583 3

### Some tips for using your Windex:

- Always assemble your Windex with Loctite® or use silicone seal on the threads to eliminate the possibility of the unit unscrewing in use from vibration.
- Prior to unstepping your mast, take your Windex down first. Periodically check the assembly screws holding your Windex together.

## UNIVERSAL MASTHEAD MOUNT

Extend your Windex 10.Sport or Windex 15 vane away from masthead obstructions and turbulence. The 13" (33 cm) arm comes with hardware allowing side or top mounting and offset angles up to ±20 degrees. May be attached securely to flat, curved, vertical, horizontal, or inclined surfaces. Gain space aloft and improve mounting position of wind finders and other equipment. Mount on the back of the mast for easier viewing from the cockpit. The mount adapts to virtually every masthead situation.

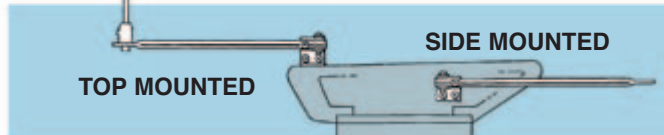

Length 13" (33 cm), weight 3.2 oz (90 g). Boom can be shortened if necessary; complete instructions included. Can be used with Windex Light #3200. Also accommodates Davis J-Base Mounts (using #10 stainless steel screws and nuts, not included).

#1705 Universal Masthead Mount

011698 17050 0

## J-BASE™ Versatile Mount for Windex 15 and Windex 10.Sport

Standard with Windex 10.Sport, J-Base can be ordered as an option for Windex 15. Allows for side, top or front mounting on most masts, on big boats or dinghies alike. J-Base is made of glass filled polycarbonate, 2" (5 cm) long. Includes stainless steel set screw and two #10 self-tapping screws. Reduces overall weight by 15 grams when substituted for standard Windex 15 mounting base.

#3155 J-Base for Windex 15

011698 00195 8

#3125 J-Base for Windex 10.Sport

011698 00194 1

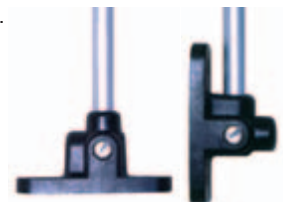

- Spare parts can be ordered from your local dealer or from Davis; identify which model you have before calling.
- Lubrication is never needed, but years of salt or dirt build-up should be rinsed off with fresh water occasionally.
- Use our Universal Masthead Mount, #1705, for installations requiring more room at the masthead. This mount extends Windex away from the masthead up to 12 inches (30 cm).
- Add an LED Windex Light #3200 for nighttime sailing.

# BLACKSMITH™ CARBON WIND VANES *Own the Wind!*

ALL DAVIS WIND VANES are precisely balanced. Vanes are effective and efficient from 0.8 to 40 knot wind conditions. Each unit is calibrated and tested. Each vane is made and balanced by hand.

**NEW**

## CRAZY KIDS

For Optimist and other small dinghies. Dimensions 7 x 11" (18 x 22 cm). Weight 0.5 oz. (14 g). Handmade of black fiber-glass and duraluminum. Carbon-free to satisfy Opti-class rules.

011698 01316 6 #3180

## SPORTBOAT

For boats 16–28 ft. (5–8.5 m). Dimensions 9 x 10" (23 x 25 cm). Weight 0.7 oz. (20 g). Handmade of 3D carbon and duraluminum. J-base included for side, top or front of mast mounting.

011698 01319 7 #3186

## OLYMPIC

For boats 13–20 ft. (4–6 m). Dimensions 9 x 9" (23 x 23 cm). Weight 0.5 oz. (14 g). Handmade of 3D carbon and duraluminum. J-base included for side, top or front of mast mounting.

011698 01318 0 #3184

J-BASE is standard with Olympic and Sport Boat

## HORIZONTAL

For Laser, Melges 14, Optimist, Finn and Sabot. Dimensions 12 x 7.8" (30 x 20 cm). Weight 0.8 oz. (23 g). Handmade of 3D carbon and duraluminum. Adjustable mast clamp.

011698 01321 0 #3188

**3D Carbon sheet, strong and lightweight, and super responsive to wind shift.**

**Duraluminum hard-coat anodizing for long lasting cosmetic wear.**



OPTIMIST MAST PIN SET

#3182 **\$1999**

011698 01317 3

## WIND-TELS™ *Fit All Shroud Sizes*



Utilizing port and starboard colored plastic vanes, **Wind-Tels** are ideal for saltwater sailing. The unique method of attachment prevents sliding or fouling of your Wind-Tels on the shrouds. Effective at any angle of heel in the lightest winds. Marine grade metal parts for durability.

#1260 Wind-Tels, 2 Pack

011698 12600 2

#1261 Extra Wind-Tel Vane Set

011698 12610 1

## AIR-FLOW TELS™

*You're Sailing Blind Without Them!*

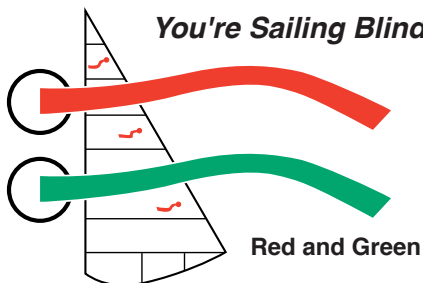

**Port and Starboard Colors**

#950  
14 TELS

011698 09500 1

Red and Green

Lightweight, ripstop nylon **Air-Flow Tels** attach to sails with waterproof adhesive locator discs. No holes required. Tels show the air flow across the sails, allowing you to trim sails for maximum performance. Each kit includes 14 Tels and full instructions on where to apply them and how to read them.

## The Original SPAR-FLY™



**America's Most Popular Wind Indicator!**

**Comes equipped with BOTH a top mount fitting and a quick-release side mount.**

The **Spar-Fly** combines needle bearing balance, high impact plastic, and marine grade metals for unsurpassed sensitivity and durability. Spoiler holes in the vane reduce lift and increase accuracy. Spar-Fly is unaffected by angle of heel. Easily seen from the deck because of its V-shaped silhouette and bright red color. Weighs only 1.25 oz. (35 grams).

#1310 Spar-Fly

011698 13100 6

#1311 Extra Spar-Fly Vane

011698 13110 5

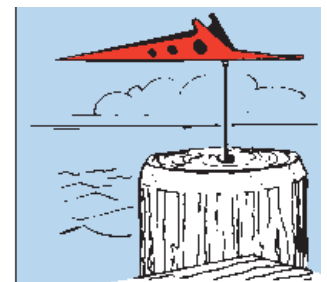

**TIP** Knowing wind direction makes docking easier. Install a Spar-Fly near your berth.

## MARK 3 SEXTANT

*Learn to Navigate!*

- Rugged, full-size instrument suitable for ocean navigation to any port in the world
- Used by professional, amateur and student navigators alike
- Sextant case with foam cushion can be purchased separately (#R014A)
- Instruction booklet included



#011  
Mark 3 Sextant

011698 00110 1

## ARTIFICIAL HORIZON

*Practice navigation without going to sea!*

*More accurate than a natural horizon...*

Use for backyard practice, finding exact position when inland, and making exact sextant shot on foggy mornings. To use, fill with water and read the angle of the reflected sun with your sextant. Half your sextant reading is the sun's angle above the true horizon. Windproof and corrosion resistant, the reflecting surface is completely enclosed. Comes with two sun shades, a lid and full directions. Compact 6 x 4 x 1 1/2" (15 x 10 x 4 cm).



#144  
Artificial Horizon

011698 01440 8

## CHARTING KIT

*Everything You Need for Chart Work!*

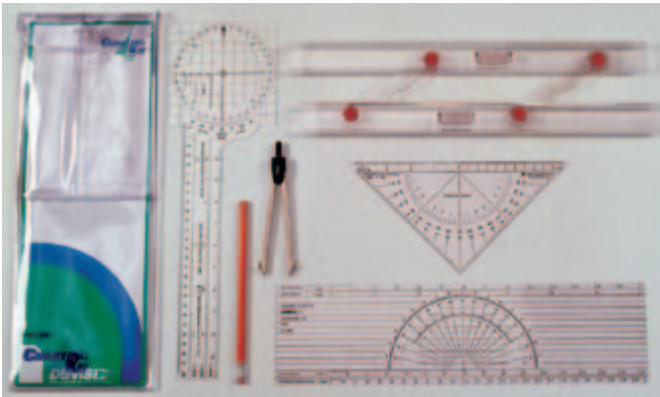

This handy kit makes chart work easy. A choice selection of navigational tools for cruisers and racers as well. Kit includes:

- **One-Arm Protractor**
- **Course Plotter**
- **Protractor Triangle**
- **Parallel Rules**
- **Professional Dividers**
- **Pencil**
- **Instruction Booklet**

All are conveniently organized in a 5 3/4" x 16 1/4" (15 x 42 cm) heavy gauge plastic carrying case. An excellent gift idea!

#083 Charting Kit

011698 00830 8

**Highest Quality Printing:**

Davis plotting tools feature sharp printing process, high gloss finish on front and back, and overlamination for durability.

## PARALLEL RULES



*The most basic plotting instrument*

Davis Parallel Rules are completely transparent with a clear optical finish for exact plotting. Each 15" (38 cm) blade features large, easy-to-grip handles. Smooth instrument action, non-slip cork pads. Precision molded for the most accurate straight line plotting money can buy!

#061 Parallel Rules 011698 00610 6

*Proven, Simple, Accurate*

## HAND BEARING COMPASS

- Cruising
- Sailing schools
- Navigation classes
- Sailboat racing
- Fishing
- Camping, hiking

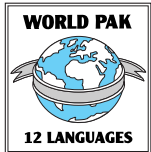

This precision marine instrument easily obtains quick magnetic bearings on shore or floating objects. Simply align front and rear sights on an object and read off bearing. Uses include quick bearing or position set, determination of angular gain or loss on the competition while racing, checking distance offshore, establishing lee-bow set while cruising or racing in currents, drift vectoring and plotting a line of position.



Grade school students using Davis Hand Bearing Compasses out in the Monterey Bay Sanctuary.



The stable, liquid-damped compass card is graduated in 5° segments, with bold graduations every 15° for easy reading. Instrument is lightweight, made of high impact plastic. Lanyard included. Solid-state LED illumination system floods the compass and sight vane with soft light. The LED will last for the lifetime of the compass. Batteries included. Complete instructions.

#215 Illuminated Hand Bearing Compass, grey

011698 02150 5

**Named "Best Buy" by PRACTICAL SAILOR:** "Simple and absolutely fool-proof, especially when you need an accurate bearing in a hurry." "What a bargain!"

# Quick Reference Cards



U.S. Coast Guard  
Auxiliary



U.S. Power  
Squadrons

Accurate Information at a Glance—Quicker than an Internet Search!

**Make your outing safer, easier... more fun!**

For quick decisions, get quick answers with Quick Reference Cards. They're efficiently formatted and full of great information. Take them along on your next outdoor adventure or classroom activity.

Cards sold separately

**All cards feature:**

- Full color both sides
- Punched for binder or bulkhead mounting
- Weatherproof high strength plastic
- Full 8 1/2 x 11" (22 x 28 cm) size

Quick Reference Cards were designed in close cooperation with the U.S. Coast Guard Auxiliary and U.S. Power Squadrons. They are standard equipment on many U.S. Coast Guard and state boating administration patrol boats.

## NAVIGATION RULES

**A Must for Safe Boating in an Easy to Use Format**

**#125** 011698 01250 3

A proven navigation tool used by the U.S. Coast Guard, U.S. Power Squadrons, and U.S. Coast Guard Auxiliary. Navigation Rules feature U.S. Buoyage System, inland and international rules, right-of-way, lights, sound signals, and bridge signals. All presented in graphic summary and easy to read. Complete, precise, accurate.



## COASTWISE PILOTING

**It's easy to forget the procedures and find yourself lost or in danger!**

**#126** 011698 01260 2

All the piloting information you need at your fingertips: dead reckoning basics, true and magnetic compass relationships, position finding, estimating distance off, current and leeway corrections. Helpful hints on chart reading, preparations and checklists, fog navigation, and depth soundings without a fathometer. Includes time, speed & distance calculator, relative bearing gauge for distance off calculations, common chart symbols.



## INTERNATIONAL NAV RULES

**The Latest Information Covering Oceans & Waterways of the World**

**#127** 011698 01270 12

A comprehensive guide incorporating the International Maritime Buoyage System and COLREGS. Clarifies differences between Cardinal and Lateral buoyage systems and buoyage regions, key to reducing confusion and danger when entering unfamiliar waters or busy harbors. Complete details on right-of-way, sound signals, entering and clearing a foreign port, lights and day shapes, collision prevention procedures, signal flags.



## BOATING GUIDE

**Small Craft Seamanship, Vital Boaters' Safety Information**

**#128** 011698 01280 0

Covers all the basic procedures and equipment. Includes predeparture checklist, recommended equipment & spare parts, fueling procedures, engine troubleshooting, radio use, trailering, launching, anchoring, water skiing hand signals. Gives rules of the U.S. Buoyage System and right-of-way. Helps in emergencies by covering distress signals, fire procedures, towing, weather warnings, first aid (hypothermia & CPR).



## WEATHER FORECASTING

**Making Marine Forecasts Using Nature's Own Signs**

**#131** 011698 01310 4

Shows the use of wind direction, barometric pressure and cloud type to predict the weather. Includes full listing of radio weather stations for official broadcasts. Has key information on navigation in fog, hazardous wave and surf conditions, storm warnings, hurricane avoidance, and more! "Time tested method...easy to understand. This is a complete guide for becoming 'weather wise.'"

—Ken Lilly Jr., CDR. NOAA (ret.), marine meteorologist



## CELESTIAL NAVIGATION

**Determine Location Using the Sun & Stars**

**#132** 011698 01320 3

A simplified, yet complete, Celestial Navigation system. Makes it easy, proving that lengthy instruction is not necessary to master celestial navigation. Includes everything you need: sextant use and corrections, starfinder for 18 stars, data entry form and step-by-step sight reduction and plotting procedures. May be scored and separated; large portion fits in sextant case for quick reference and, small part acts as a waterproof data reduction card.



Presorted  
 Standard  
 US Postage  
**PAID**  
 Davis Instruments

CHANGE SERVICE REQUESTED



**Davis Scrubbis™  
 Boat Hull Care**

The Scrubbis system is the easy, effective way to clean your hull while it's still in the water. No diving!  
 (p. 16)



**Blacksmith™  
 Carbon Wind Vanes**

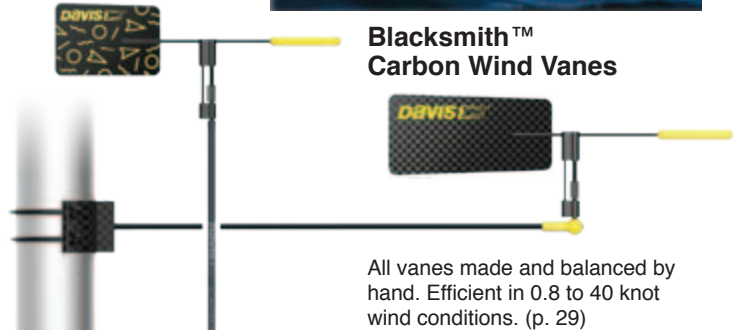

All vanes made and balanced by hand. Efficient in 0.8 to 40 knot wind conditions. (p. 29)

Davis is a proud member of . . .

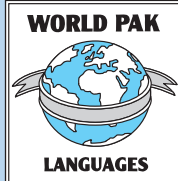

Look for the World Pak symbol indicating language translations printed on packaging and instructions. Some of these Davis products feature up to 17 languages in addition to English.

Can't find it at your local Davis retailer? Call 1 (800) 678-3669 or visit us on the web at [www.davisinstruments.com/marine](http://www.davisinstruments.com/marine).

**Customer Service Representatives** Our representatives can answer most questions, assist with your purchase, or provide product literature. Lines are staffed weekdays 7:00 a.m. to 5:00 p.m. Pacific Time. 1 (510) 732-9229

**Fax Line** Available day or night to place orders or submit questions: 1 (510) 670-0589

**Technical Support Representatives** For technical questions or trouble-shooting help (7:00 a.m. to 5:30 p.m., Pacific): 1 (510) 732-7814  
 Technical Support Fax Line: 1 (510) 670-0589

**E-Mail Directory**  
 Customer Service Department: [sales@davisinstruments.com](mailto:sales@davisinstruments.com)  
 Technical Support Department: [support@davisinstruments.com](mailto:support@davisinstruments.com)  
 For comments or general questions about Davis: [info@davisinstruments.com](mailto:info@davisinstruments.com)

**World Wide Web**  
 To locate our site: <http://www.davisinstruments.com>  
**Mailing Address** Send correspondence to:  
 Davis Instruments  
 3465 Diablo Ave., Hayward, CA 94545-2278 U.S.A.

**Attractive Displays** are free of charge to dealers.

**One-Year Warranty**  
 We warrant our products to be free of defects in material and workmanship for one year from the date of original purchase. Certain products are guaranteed unbreakable for the life of the product. Write for full warranty details.



Scan for more information on Davis products.