

*Where are we
cooking today?*

Catalogue
2024

Heritage

Born from a love of camping and outdoor living, coupled with a desire to always create and innovate, Campingaz® products are instinctive and inspired, simple yet clever solutions based on over 70 years of expertise.

Campingaz® stands for safe and reliable products that are made to stay with you. Be a part of our family!



1949
Stoves



1970's
Coolers



1980's
Valve Cartridges



1990's
Barbecues



2010's
Xcelerate™ Stoves



It's the simple things that count...



Often simple thoughts spark big ideas; in 1949, when a young man embarked on a camping holiday with his family, he could never have anticipated that his thoughts that day would change the way in which people camped for generations to come.

Frustrated by the alternatives available, he set about creating a revolutionary refillable cylinder; compact and convenient, economic and easy to use. The Campinggaz® brand was born...and life outdoors was liberated.

From the beach to the campsite, or from the garden to the hills, Campinggaz® innovations have changed the blueprint for outdoor cooking and adventure, each decade introducing revolutionary innovations.

With over 70 years as a leader in outdoor gas and gas appliances and 70 years experience as the Outdoor Cooking Expert®, Campinggaz® has created reliable products that also form lasting memories.

**2012
Planchas**



**2014
Barbecue Relaunch**



**2017
Master Series**



**2021
New Barbecue Range**



The simple pleasures are the best.

The flavour of food cooked outdoors. The warm glow of evenings by lantern light. These are the moments, the memories and the feelings that inspire us at Campingaz[®], and have done for 67 years.

Since 1949 we've enhanced people's experience of the outdoors, becoming part of their life. We continue to innovate and inspire our versatile products that suit all your outdoor needs or wherever your adventurous spirit takes you. All our products are designed with one aim in mind: to make outdoor freedom accessible to everyone.

Today we still believe in that combination of practicality and inspiration – whether in your own back garden, on a beach or camping far from home. We continue to innovate because we know there are always smarter ways to do things, but we retain the classic solutions you know and love.

Barbecues	4
Barbecue Accessories	62
Cartridges	72
Versatile Urban & Caravan Grilling	77
Coolers	106
Lanterns	122
DIY	127
Help Section	130
Legal	130



Barbecues

Smart technology embedded in appealing designs. Our extensive range of barbecues features the perfect model for every consumer.





Our Barbecue Range

The Campinggaz® BBQ range offers a wide selection of barbecues. Every enthusiastic sizzler, from the barbecue novice to the passionate gourmet griller, will find the perfect barbecue within the Campinggaz® assortment.

PREMIUM SERIES RANGE

Perfect for big families and hosting friends. Guaranteeing significantly less flare-ups, perfectly even heat distribution, stylish exterior and the revolutionary Campinggaz® InstaClean™ Aqua system. The new 4 & 3 Series is packed with benefits so you will want to barbecue all the time.



4 Series Onyx S



4 Series Premium S



3 Series Premium S

SELECT

Select the right BBQ! The new Select range is proudly made in Italy and delivers on quality and performance; catering to all of your barbecue needs.



Select 4 LX Plus



Select 3 LX Plus

COMPACT

Made in Italy, the Compact BBQ comes with 3 burners that deliver on performance, yet built for smaller backyards.



Compact 3 L



Compact 3 EXS

CLASSIC SERIES

Tried and tested, our Classic Series barbecues bring down-to-earth grilling pleasures to each and everyone.



4 Series LS Plus D



4 Series Classic LXS



4 Series Classic WLD



3 Series LS Plus D



3 Series LD Plus



3 Series WLD

2 SERIES

Great performance for folks with smaller backyards.



2 Series EXS Vario D



2 Series LX Vario



2 Series Classic L

XPERT

The Campingaz® XPERT range delivers high quality & performance for its class. Ideal for beginners and people looking to use smaller spaces.



Xpert 200L Vario



Xpert 100 L

ATTITUDE

The Campingaz® Attitude Series of table top barbecues pairs sleek, urban styling with pioneering precision cooking, all within a compact, portable package.



Attitude 2100 LX



Attitude 2 Go



A woman with curly blonde hair, wearing a white t-shirt, is smiling and looking towards the right. In the background, another woman is visible, and there are trees and a wooden deck. In the foreground, a barbecue grill is visible with a skewer of food on it.

PREMIUM AND ONYX BARBECUES

Cook up a feast for family and friends with our premium series barbecues. Featuring efficient and high-performance stainless steel burners with our efficient Blue Flame Power System that ensures significantly less flare ups by design and keeps your food nice and juicy. Together with a large, enamelled cooking surface these barbecues are perfect for preparing a wide range of al fresco meals. The included Campingaz® Culinary Modular System provides keen grillers with even greater cooking versatility. Cleaning is quick and hassle-free thanks to the Campingaz® InstaClean™ Aqua System. Our newest addition to the Campingaz® Barbecue range make for the perfect companion: Either for hungry families as a 4 Burner or for everyone who loves high quality barbecue as a space efficient 3 Burner.



BLUE FLAME POWER SYSTEM



Significantly less flare ups by design!



The new Blue Flame power system by Campingaz® offers accelerated pre-heating, optimal heat distribution and significantly less flare ups by design.

The new shaped burner cleverly distributes flames under the entire grilling surface offering a perfectly even heat distribution. The burner protection is integrated into the cast iron grids removing the burner protection layer below the cooking surface. Hot grease and juices

are thereby prevented from collecting and causing dangerous flames in the fire box. Water from the InstaClean™ Aqua further assists in keeping inflammation in check.

The new stainless steel burners of the Blue Flame power system come with a 5 year warranty.

The new Campingaz® Blue Flame power system; durable, powerful and efficient burners for the perfect sizzle!

Keep it juicy AND crispy!



There is nothing better than grilling fresh food on your barbecue. But how do you keep it juicy without sacrificing that delicious crunch?

The Campingaz® Blue Flame power system generates delicate water evaporation, that locks in the succulent moisture of your food without losing the crispy barbecued crust.

Similarly, to how crusty loaves of bread are made, the Blue Flame power system keeps your grilled food juicy & crispy, whether you are grilling or roasting.



* Third Party testing confirms the new Campingaz® BBQ Series with the Blue Flame power burner keeps food juicy and improves crispiness for an overall better grilling result, when compared to the traditional burner of the Campingaz® BBQ Classic Series. For more information visit campingaz.com/keepitjuicy

INSTACLEAN™ AQUA SYSTEM



No more scrubbing!



Effortless cleaning thanks to InstaClean™ Aqua System.

We love to grill – but cleaning is always a pain. Good news: Our Campinggaz® Instaclean™ system just got even better.

Integrated in our Series barbecues, the clever and effortless Campinggaz® Instaclean™ Aqua technology harnesses the power of water to make cleaning a piece of cake.

Water is filled into the front-loading grease drawers, preventing all residual grease and food waste, from baking into the material. Similarly, the small amount of resulting evaporation during your grilling session, also works as a grease repellent, preventing

grease and grime from burning into the firebox materials. When it's time to clean, thanks to this clever system, you can remove the greasy grill parts and simply wash them off. No scrubbing required!

The waste water in the grease drawer can simply be drained by removing a plug. Premium and Onyx models come fitted with a waste water container including a removable filter to separate dense grease, making waste water disposal even more convenient.

Quick, effortless and squeaky clean!

CAMPINGGAZ® CULINARY MODULARS



Unleash your grilling creativity with prolonged cooking versatility



Extend your kitchen outdoors with Campingaz® interchangeable cooking solutions!

Simply take out the inner ring of the cast iron modular, or remove/reverse the adjacent griddle and insert one of the various Campingaz® Culinary Modular Barbecue Accessories. (items sold separately)

Culinary Modular System integrated in all Campingaz® Master, Onyx, Premium and Select models. System integration can vary on Classic range.

The Campingaz® Culinary Modulares offer every option your gourmet barbecue heart desires.

ONYX AND PREMIUM SERIES

4 Series Onyx S

2000037288

3D



Reversible, enamelled cast iron griddle



InstaStart™ intuitive one-touch ignition with illuminated safety controls

Supports up to 13kg gas bottles within a fully enclosed trolley with streamlined design and integrated bodykit wheel chassis

All-Terrain caster wheels with brakes offer easy mobility across all surfaces and a secure stance

Powerful side burner for preparing sauces or boiling other side dishes

Improved storage solution with Campingaz® Push2Fold folding side tables

5 year warranty on the Campingaz® Blue Flame Power System and cooking surfaces



4 Series Premium S

2000037286



Reversible, enamelled cast iron griddle



Electric ignition offers convenient lighting with batteries are included

Supports up to 13kg gas bottles within a partly enclosed trolley with doors

Swivel castors with brakes offer convenient mobility and manoeuvrability

Improved storage solution with Campingaz® Push2Fold folding side tables

Integrated utensil hooks for easy access and convenient storage of grilling accessories

5 year warranty on the Campingaz® Blue Flame Power System and cooking surfaces

3 Series Premium S

2000037280



Reversible, enamelled cast iron griddle



Electric ignition offers convenient lighting with batteries are included

Supports up to 13kg gas bottles within a partly enclosed trolley with doors

Swivel castors with brakes offer convenient mobility and manoeuvrability

Improved storage solution with Campingaz Push2Fold folding side tables

Integrated utensil hooks for easy access and convenient storage of grilling accessories

5 year warranty on the Campingaz® Blue Flame Power System and cooking surfaces

Campingaz® Blue Flame Burners



Campingaz® InstaClean™ Aqua System



Campingaz® Culinary Modulars



Campingaz® Push2Fold side tables



Significantly less flare-ups by design



ONYX AND PREMIUM SERIES



	4 Series Onyx S	4 Series Premium S	3 Series Premium S
SKU	2000037288	2000037286	2000037280
EAN	3138522119294	3138522119270	3138522119218
Country of Origin	CN	CN	CN
Cooking Surface (cm ²)	3312	3312	2806
Cooking Dimensions (cm)	46 x 72	46 x 72	46 x 61
Burner Technology	New Blue Flame Power System in stainless steel	New Blue Flame Power System in stainless steel	New Blue Flame Power System in stainless steel
No of burners	4	4	3
Power (kW) breakdown per burner	13.6 + 2.3	13.6 + 2.3	10.2 + 2.3
Gas consumption breakdown	330 g/h + 167g/h	330 g/h + 167g/h	247g/h + 167g/h
Cleaning System	InstaClean™ Aqua Pro with grease drawers accessible from the front and integrated grease evacuation cups with filter in each door	InstaClean™ Aqua Pro with grease drawers accessible from the front and integrated grease evacuation cups with filter in each door	InstaClean™ Aqua Pro with grease drawers accessible from the front and integrated water cup with filter in door
Material	Porcelain enamelled cast iron	Porcelain enamelled cast iron	Porcelain enamelled cast iron
Cooking surface configuration	Grid + Rev. Griddle	Grid + Rev. Griddle	Grid + Rev. Griddle
Culinary Modular System	Yes	Yes	Yes
Warming Rack	(2) 17 x 35 cm	(2) 17 x 35 cm	17 x 62 cm
Rotisserie Option	Yes	Yes	Yes
Cooking Height	95 cm	93 cm	93 cm
Ignition	InstaStart™	Electronic	Electronic
Thermometer	Yes	Yes	Yes
Foldable side table(s)	Left side-table foldable	Left side-table foldable	Left side-table foldable
Side burner	Yes	Yes	Yes
Lid Material	painted steel + painted aluminium	painted steel + painted aluminium	painted steel + painted aluminium
Trolley Material	painted steel	painted steel	painted steel
Trolley chassis configuration	Doors closed sides closed back	Doors closed sides open back	Doors closed sides closed back
Number and type of Wheels	4x all terrain master castors	4x swivel castors	4x swivel castors
Gas bottle storage and usage compatibility	13kg	13kg	13kg
Weight kg	82	77	69
"Dimensions (W x D x H) in cm (open)"	157 x 70 x 150	157 x 69 x 148	146 x 69 x 148
"Dimensions (W x D x H) in cm (closed)"	135 x 64 x 121	135 x 60 x 119	124 x 60 x 121
Warranty	5 years on lid 5 years on burner 5 years on cooking surfaces	5 years on lid 5 years on burner 5 years on cooking surfaces	5 years on lid 5 years on burner 5 years on cooking surfaces
Optional cover	Premium Barbecue Cover XL (2000037292)	Premium Barbecue Cover XL (2000037292)	Premium Barbecue Cover L (2000037291)

SUGGESTED ACCESSORIES



Premium Barbecue Cover XL

2000037292
See page 70



Culinary Modular Pizza Stone and Pizza Cutter

2000014582
See page 66



Culinary Modular Mandarin Wok

2000038449
See page 63



Culinary Modular Poultry Roaster

2000014576
See page 66



Stainless Steel Tongs

2000014567
See page 67



BRUSH 3 IN 1

2000032608
See page 66

CAMPINGAZ® FEATURES*



Powerful stainless steel Blue Flame Power System ensures perfectly even heat distribution, significantly less flare ups and keeps your food juicy and crisp



5 year warranty on lid, stainless steel blue flame burners and on cast iron grids and griddles



Revolutionary Campingaz® InstaClean™ Aqua ensures smart and effortless cleaning



Intuitive one-touch InstaStart™ ignition



Maximise your cooking and grilling options with the Campingaz® Culinary Modularity



Illuminated safety controls signify when the gas is on



Integrated grease evacuation container included on all InstaClean™ Aqua Pro models (number of containers included varies per model)



Significantly less flare-ups by design



Number of people that can be comfortably served per grilling session

*Depending on model

SELECT

Select the right BBQ! The new Select range of BBQ's make it easy to find the right BBQ for you.

Whether its 3 or 4 burners for small and larger families, a cast iron cooking surface that includes the Culinary Modular System for those inspiring grillers or a steel cooking surface for those that want value for money. Now made in Italy, the new Select range has something for everyone.





CAMPINGGAZ® CULINARY MODULARS



Versatile cooking and grilling options are quick and convenient with Campingaz® Culinary Modulares



Extend your kitchen outdoors with Campingaz® interchangeable cooking solutions!

Simply take out the inner ring of the cast iron modular, or remove / reverse the adjacent griddle and insert one of the various Campingaz® Culinary Modular Barbecue Accessories. (items sold separately)

The Campingaz® Culinary Modulares offer every option your gourmet barbecue heart desires.

Cast iron Culinary Modular Grid is included on the following Select models: All 3 and 4 burner LX Plus and EXS models

EVEN TEMP™ TECHNOLOGY

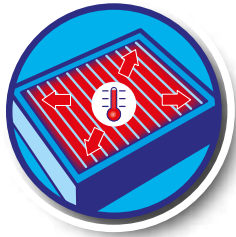

Even Temp™ Technology Guarantees Even Heat Distribution



Grill effectively and efficiently with our Even Temp™ Technology for perfectly even heat distribution

Campingaz® BBQs with Even Temp™ Technology cook your food evenly across the entire cooking surface of your barbecue.

Thanks to the patented Even Temp™ Technology, Campingaz® barbecues reach

more than 250°C on the cooking surface.

This system is featured on all 4 & 3 Series, Select and Attitude Barbecues and Master Plancha and Blue Flame Planchas

INSTACLEAN™ SYSTEM



**Discover the ease of BBQ
cleaning** with the Campingaz[®]
InstaClean™ System



**Quick and simple!
Let your dishwasher do the work!**

The system allows you to remove all dishwasher safe parts in less than 60 seconds. The dishwasher will help remove remaining oil and grease.

All parts are designed to fit a standard dishwasher for even easier cleaning

INSTACLEAN™ EASYFLOW

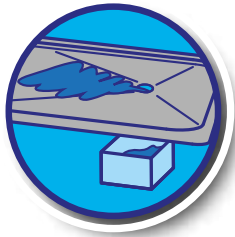

Making cleaning up even easier
The new Campingaz® InstaClean™ Easyflow



Keep your BBQ ready for action

The InstaClean™ EasyFlow grease tray directs grease into the grease collection container while cooking so that you can easily keep your barbecue clean and ready for action

The grease tray and container are easily removable from the barbecue and can be cleaned effortlessly after every grilling session.

Tip: fill your grease collection container with some water to prevent grease from sticking to the plastic and make it easier to clean.

SELECT 4

Select 4 LX Plus

2181083



Reversible, enamelled cast iron grille



Electric ignition offers convenient lighting with batteries that are included

InstaClean™ system, discover the ease of BBQ cleaning

Powerful and Durable **Stainless steel burners**

Even Temp™ Technology provides even heat distribution

Powerful side burner for preparing sauces or boiling other side dishes





Campingaz® InstaClean™
System



Campingaz® Culinary
Modulars



Campingaz® side
tables



Even Temp™
technology



SELECT



	Select 4 LX Plus	Select 3 LX Plus
SKU	2181084	2181071
EAN code	3138522128524	3138522128395
Country of Origin	IT	IT
Cooking Size (cm ²)	3000	2500
Cooking Dimensions (cm)	75 x 40	62.5 x 40
Burner	Stainless steel	Stainless steel
No of burners	4	3
Power (kW) total	12	9
Gas consumption total (g/h)	873	655
Cooking surface material	Semi Shiny Enameled Cast Iron	Semi Shiny Enameled Cast Iron
Cooking surface configuration	Grid / Griddle	Grid / Griddle
Warming Rack	Yes	Yes
Cooking height	87 cm	87 cm
Ignition	Electronic	Electronic
Thermometer	Yes	Yes
Side tables	Yes	Yes
Foldable side table(s)	2	2
Side Burner	No	No
Lid Material	Painted steel and painted Aluminium	Painted steel and painted Aluminium
Trolley Material	Steel	Steel
Trolley configuration	Doors + side panels	Doors + side panels
Wheels	2 x turf wheels + 2 x swivel castors	2 x turf wheels + 2 x swivel castors
Weight (kg)	54	50
Dimensions (WxDxH) in cm open	142,7 x 65,6 x 142,5	131 x 65,6 x 142,5
Dimensions (WxDxH) in cm closed	110 x 57 x 112,5	97,8 x 56,8 x 112,5
QT master carton (units)	1	1
Optional cover	Premium Barbecue Cover L (2182133)	Premium Barbecue Cover M (2182037)

SUGGESTED ACCESSORIES



Premium Barbecue Cover L

2182133
See page 70



Culinary Modular Pizza Stone and Pizza Cutter

2000014582
See page 66



Culinary Modular Mandarin Wok

2000038449
See page 67



Culinary Modular Poultry Roaster

2000014576
See page 66

CAMPINGAZ® FEATURES*



Discover the ease of BBQ cleaning with the Campingaz® InstaClean™ System



More cooking possibilities with a side burner that can be used with standard pots and pans.



Maximise your cooking and grilling options with the Campingaz® Culinary Modulares



3 year warranty on lid, stainless steel burners and on cast iron grids and griddles



Number of people that can be comfortably served per grilling session



Made in Italy



Even heat distribution and great results with our Even Temp™ Technology



Instaclean™ Easyflow grease tray directs grease into the grease container

*Depending on model

COMPACT

The latest Campingaz® Compact BBQ has been designed with the new Campingaz® signature in mind; giving you a sleek looking, optimal performing BBQ at great value. Not only has the Compact been designed in Europe but the Compact BBQ is now manufactured in Italy

The 3 powerful aluminized steel burners deliver 7500 watts that provide greater heat distribution and even temperature diffusion throughout, allowing you to utilize the full cooking surface making sure all your food is cooked evenly.

The newly developed Compact has fold down side tables allowing for easy storage in tight spaces and can be relocated effortlessly with the use of 2 large wheels.





COMPACT

Compact 3 EXS

2181063



Reversible, enamelled cast iron griddle



- Side table** folds down for easy storage
- Grease tray** is easily accessible
- Cast iron** cooking surface for perfectly grilled food
- Integrated side burner** for preparing vegetables or sauces while grilling
- Convenient thermometer** enables heat monitoring and control
- Convenient piezo ignition** for matchless lighting
- Trolley doors** to conceal gas bottle during storage





Traditional Tube Burners



Foldable Side Table(s) for flexible storage



Easily accessible grease tray



2 Wheels for Mobility



COMPACT



	Compact 3 EXS	Compact 3 L
SKU	2181063	2181054
EAN code	3138522128319	3138522128227
Country of Origin	IT	IT
Cooking Surface (cm ²)	2135cm ²	2135cm ²
Cooking Dimensions (cm)	61 x 35	61 x 35
Burner	Traditional Tube Burner	Traditional Tube Burner
No of burners	3	3
Power (kW) total	9.6	7.5
Gas consumption total (g/h)	699	546
Cooking surface material	Semi Shiny Cast Iron	Shiny Enameled Steel
Cooking surface configuration	Grid / Griddle	Grid/ Grid
Warming Rack	Yes	No
Cooking height	87 cm	87 cm
Ignition	Piezo	Piezo
Thermometer	Yes	Yes
Side tables	2	2
Foldable side table(s)	1	2
Side Burner	Yes	No
Lid Material	Double Painted steel + Painted aluminium	Double Painted steel + Painted aluminium
Trolley Material	Steel	Steel
Trolley configuration	2 Doors	100% steel front with integrated condiment shelf
Wheels	2	2
Weight (Kg)	39	32
Dimensions (WxDxH) in cm open	124,2 x 55 x 135	124,2 x 55 x 135
Dimensions (WxDxH) in cm closed	108 x 53 x 108	91 x 53 x 108
QT master carton (units)	1	1
Optional cover	Classic Barbecue Cover S (2182039)	Classic Barbecue Cover S (2182039)

SUGGESTED ACCESSORIES



Classic Barbecue Cover S

2182039
See page 70



Premium Barbecue Glove

2000035057
See page 68



3 in 1 Steel & Brass Bristled Brush

2000032608
See page 66

CAMPINGGAZ® FEATURES*



Made in Italy



Integrated thermometer in lid improves heat monitoring



More cooking possibilities with a side burner that can be used with standard pots and pans.



Piezo ignition ensures convenient and matchless lighting



Side tables fold down for space saving storage



Number of people that can be comfortably served per grilling session



Traditional tube burners

A photograph of a family of four (a woman, an older woman, and a man) sitting at a wooden picnic table outdoors. They are smiling and appear to be enjoying a meal. The woman in the foreground is leaning over the table, and the man is holding a corn on the cob. The background shows a large tree and a bright, sunny day.

CLASSIC SERIES

Cook up a feast for family and friends with our Classic Series barbecues. Featuring efficient and high-performance stainless steel tube burners together with a large, enamelled cooking surface these barbecues are perfect for preparing a wide range of al fresco meals. While the Even Temp[®] Technology offers perfectly even heat distribution. Cleaning is quick and hassle-free thanks to the Campingaz[®] InstaClean[™] System.



INSTACLEAN™ SYSTEM



Discover the ease of BBQ cleaning
with the Campingaz® InstaClean™ System



Quick and simple! Let your dishwasher do the work!

The system allows you to remove all dishwasher safe parts in less than 60 seconds. The dishwasher will help remove remaining oil and grease.

All parts are designed to fit a standard dishwasher for even easier cleaning,

This system is featured on 3 and 4 Series barbecues.

Now it's also available as an accessory - Renew your firebox !



EVEN TEMP™ TECHNOLOGY

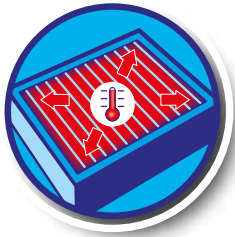

Even Temp™ Technology Guarantees Even Heat Distribution



Grill effectively and efficiently with our Even Temp™ Technology for perfectly even heat distribution

Campingaz® BBQs with Even Temp™ Technology cook your food evenly across the entire cooking surface of your barbecue.

This system is featured on all 4 & 3 Series, Attitude Barbecues and Master Plancha and Blue Flame Planchas

Thanks to the patented Even Temp™ Technology, Campingaz® barbecues reach more than 250°C on the cooking surface.



CAMPINGGAZ® CULINARY MODULARS



Versatile cooking and grilling options are quick and convenient with Campingaz® Culinary Modulares



Extend your kitchen outdoors with Campingaz® interchangeable cooking solutions!

Simply take out the inner ring of the cast iron modular, or remove / reverse the adjacent griddle and insert one of the various Campingaz® Culinary Modular Barbecue Accessories. (items sold separately)

The Campingaz® Culinary Modulares offer every option your gourmet barbecue heart desires.

Cast Iron Culinary Modular Grid included on the following models: all 3 and 4 Series EXS, all 3 and 4 Series LX, LXS, L Plus and LS Plus models

Cast Iron Culinary Modular Grid available as an upgrade and replacement for all 3 and 4 Series models, Master Series BBQs



STAINLESS STEEL TUBE BURNERS



Powerful and durable stainless steel burners for long lasting grilling dinners!



All Campingaz® 4/3/2 Series barbecues have a 3 year warranty on stainless steel tube burners

Enjoy great cooking performance with this smart burner system designed to perfectly grill all types of foods.

Specially designed burners create V-shaped flames that are directed towards the cooking grid and spread the heat evenly across the cooking surface.

The specifically designed burner protector, with protected ventilation slots, supports even heat distribution and prevents flare-ups.

CLASSIC SERIES



	4 Series LS Plus D	4 Series Classic LXS	4 Series Classic WLD	3 Series LS Plus D
Reference	2000031360	2000015647	3000006788	2000031359
EAN code	3138522097769	3138522070847	03138522099725	3138522097752
Country of Origin	CN	CN	IT	CN
Cooking surface (cm ²)	3,500	3,500	3,500	2,800z
Cooking Dimensions (cm)	78 x 45	78 x 45	78 x 45	61 x 45
Burner	Stainless Steel Tubes with 3 year warranty	Stainless Steel Tubes with 3 year warranty	Stainless Steel Tubes with 3 year warranty	Stainless Steel Tubes with 3 year warranty
Number of burners	4	4	4	3
Power	12.8 + 2.3 kW	12,8 kW + 2,3 kW	12.8 kW	9.6 kW + 2.3 kW
Gas consumption	931 + 167g/h	931 + 167g/h	931g/h	698 + 167g/h
Campingaz® InstaClean™ System	Yes	Yes	Yes	Yes
Cooking surface material	Enamelled Stamped Steel	Matt Enameled Cast Iron	Shiny Enameled cast iron	Matt Enameled Cast Iron
Cooking surface configuration	Grid / Griddle	Grid with insert / Griddle (turnable)	Grid with insert / Griddle (turnable)	Grid with insert / Griddle (turnable)
Ready for Culinary Modular Barbecue Accessories	Optional	Optional	Optional	Optional
Warming rack(s)	75 x 17 cm	Yes	75 x 17 cm	Yes
Rotisserie Option	Yes	Yes	Yes	Yes
Cooking height	90.5 cm	TBC	TBC	TBC
Ignition	Piezo	Electronic	Piezo	Piezo
Thermometer	Yes	Stainless steel frame, with probe	Yes	Stainless steel frame, with probe
Side table(s)	2	2	2	2
Folding side table(s)	1	Folding side table 1	1	1
Side burner	1	1	-	1
Lid material	Enamelled cast iron	Enameled Steel with aluminum die cast sides	Steel & aluminium die cast	Painted steel with aluminum die cast sides
Trolley material	Steel	Steel	Steel with wooden side tables	Steel
Trolley configuration	2 doors, sides closed	2 doors, sides closed	Closed front panel with integrated basket	2 doors, sides closed
Wheels	4 caster wheels	4 small wheels	2 large wheels	4 small wheels
Weight	57 kg	63,9 kg	52.2 kg	55,9 kg
Dimensions (L x W x H) in cm (open)	160,5 x 65,5 x 147	160,5 x 65,5 x 147	141,5 x 66 x 142	144 x 65,5 x 147
Dimensions (L x W x H) in cm (closed)	137 x 60,5 x 116	137 x 60,5 x 116	122 x 64,5 x 111	120,5 x 60,5 x 116
Qt. master carton (units)	1	1	1	1
Optional cover	Premium XL (2000037292) Classic XL (2000037297)	Premium XL (2000037292) Classic XL (2000037297)	Premium XL (2000037292) Classic XL (2000037297)	Premium L (2000037291) Classic L (2000037296)

SUGGESTED ACCESSORIES



3 Series LD Plus	3 Series Classic WLD
2000038738	3000006789
3138522124229	3138522104719
CN	IT
2,800	2,800
61 x 45	61 x 46
Stainless Steel Tubes with 3 year warranty	Stainless Steel Tubes with 3 year warranty
3	3
9.6 kW	9.6 kW
698g/h	698g/h
Yes	Yes
Shiny Enamelled Cast Iron Grid / Enamelled steel griddle	Enamelled Stamped Steel
Grid / Griddle	100% Grid + additional 1/3 plancha
Optional	Optional
60 x 17 cm	60 x 17 cm
Yes	Yes
86.5 cm	86.5 cm
Piezo	Piezo
Yes	Yes
2	2
2	2
-	-
Steel & aluminium die cast	Steel & aluminium die cast
Steel	Steel with wooden side tables
2 doors, sides closed	Closed front panel with integrated basket
4 caster wheels	2 large wheels
49.8 kg	43.3 kg
144 x 65.5 x 147	125 x 66 x 142
97 x 60.5 x 116	105.5 x 64 x 111
1	1
Premium L (2000037291) Classic L (2000037296)	Premium L (2000037291) Classic L (2000037296)



Premium Barbecue Cover L

2000037291
See page 70



Premium Barbecue Glove

2000035057
See page 68



Culinary Modular Poultry Roaster

2000014576
See page 66



Stainless Steel Tong

2000014567
See page 67

CAMPINGAZ® FEATURES*



Even heat distribution and great results with our Even Temp™ Technology



3 year warranty on stainless steel tube burners, providing strong performance and even heat



Improved Campingaz® InstaClean™ System ensures quick and effortless cleaning



Intuitive one-touch InstaStart™ ignition



Maximise your cooking and grilling options with the Campingaz® Culinary Modulares



Illuminated safety controls signify when the gas is on



Number of people that can be comfortably served per grilling session

2 SERIES

Proving that good things come in small packages, the 2 Series Classic features a compact design with folding side tables for easy storage. Perfect for budget-conscious food lovers, the 2 Series Classic can be stored compactly until needed and is ideal for impromptu outdoor meals. Powerful stainless steel burners (EXS) offer effective and even heat and the family-sized enamelled cooking surface makes cooking for smaller groups effortless!





2 SERIES

2 Series EXS Vario D

3000006591



Stainless steel burner ensures durability for many seasons

Integrated side burner for preparing vegetables or sauces while grilling

Utensil hooks for hanging cooking accessories

Convenient thermometer enables heat monitoring and control

Convenient piezo ignition for matchless lighting

Trolley doors to conceal gas bottle during storage





**Stainless Steel Burners
(included on EXS)**



**Foldable Side Table(s) for
flexible storage**



Warming Rack



2 Wheels for Mobility



2 SERIES



	2 Series EXS Vario D	2 Series LX Vario	2 Series Classic L
Reference	3000006591	3000005424	3000005439
EAN code	3138522070656	3138522103484	3138522103637
Country of Origin	IT	IT	IT
Cooking surface (cm ²)	2,100	2,100	2,100
Cooking Dimensions (cm)	60 x 35	60 x 35	60 x 35
Burner	Stainless Steel	Aluminised Steel	Aluminised Steel
Number of burners	2	2	2
Power	7.5 + 2.1 kW	7,5 kW	7.5 kW
Gas consumption	546 + 153g/h	546g/h	546g/h
Cooking surface material	Enamelled cast iron	Enameled stamped steel	Enamelled stamped steel
Cooking surface configuration	Grid /Griddle	Grid/Griddle	Grid
Warming rack(s)	56 x 15 cm	56 x 15 cm	56 x 15 cm
Cooking height	87 cm	TBC	87 cm
Ignition	Piezo	Piezo	Piezo
Thermometer	Yes	Yes	Yes
Side table(s)	2	2	2
Folding side table(s)	1	2	2
Side burner	1	-	-
Lid material	Steel	Painted Steel with die-cast handle holders	Steel
Trolley material	Steel	Steel	Steel
Trolley configuration	2 doors, sides closed	100% steel front with integrated condiment shelf	50% Steel front with integrated condiment shelf
Wheels	2	2	2
Weight	35 kg	31,8 kg	33.2 kg
Dimensions (W x D x H) in cm (open)	124.5 x 65.5 x 134.5	124.5 x 65.5 x 134.5	124.5 x 65.5 x 134.5
Dimensions (W x D x H) in cm (closed)	106 x 51 x 109	87 x 51 x 109	87 x 51 x 109
Qt. master carton (units)	1	1	1
Optional cover	Premium M (2000037290) Classic M (2000037295)	Premium M (2000037290) Classic M (2000037295)	Premium M (2000037290) Classic M (2000037295)

SUGGESTED ACCESSORIES



Premium Barbecue Cover M

2000037290
See page 70



3 in 1 Steel & Brass Bristled Brush

2000032608
See page 68



Premium Plancha Spatula

2000035410
See page 67



Stainless Steel Tongs

2000014567
See page 67



Premium Barbecue Glove

2000035057
See page 68

CAMPINGGAZ® FEATURES*



Stainless steel burners (included on EXS)



Integrated thermometer in lid improves heat monitoring



More cooking possibilities with a side burner that can be used with standard pots and pans.



Piezo ignition ensures convenient and matchless lighting



Side tables fold down for space saving storage



Number of people that can be served per grilling session

*Depending on model

XPERT

The Campingaz® Xpert range has been designed with a modern, fresh style, offering great value for money and is perfect for couples or smaller families. The Xpert barbecues are available in 2 different sizes.

Each model of the Campingaz® Xpert range comes with a steel cooking lid and two burners, while reliable piezo ignition makes for a fuss-free start to your barbecue.



XPERT

Xpert 200L Vario

3000005548



Piezo ignition ensures quick and convenient matchless ignition

Foldable side tables with utensil hooks for hanging cooking accessories

Thermometer to control the temperature

Steel front with integrated shelf for easy storage of condiments and seasoning

Two big wheels to ensure mobility also on uneven surfaces

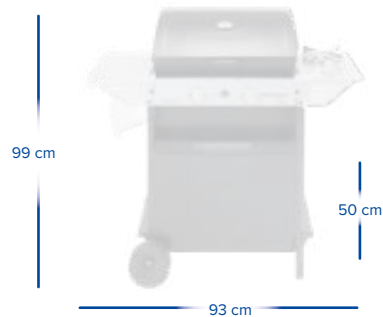
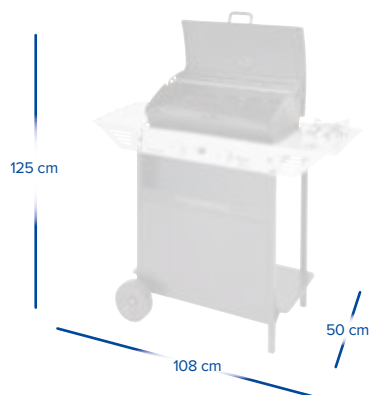



Double Burner



Foldable Side Table



Cooking Lid with integrated thermometer



Integrated condiment shelf



XPERT



	Xpert 200 L Vario	Xpert 100 L
Reference	3000005548	3000004820
EAN code	3138522104665	3138522096267
Country of Origin	IT	IT
Cooking surface (cm ²)	1800	1500
Cooking Dimensions (cm)	54 x 34 cm	45 x 34 cm
Burner	Aluminised Steel	Aluminised Steel
Number of burners	2	2
Power	71 kW	71 kW
Gas consumption	515 g/h	515 g/h
Cooking surface material	Enamelled Stamped Steel	Chromed Wire Grid
Cooking surface configuration	Grid/Griddle	Grid
Cooking height	86cm	86cm
Ignition	Piezo	Piezo
Thermometer	Yes	-
Side table(s)	2	2
Folding side table(s)	2	2
Side burner	-	-
Lid material	Painted Steel	Painted Steel
Trolley material	Steel	Steel
Trolley configuration	Front panel with integrated basket, side/back open	100% Textile screen, side/back open
Wheels	2	2
Weight	23 kg	15.4 kg
Dimensions (W x D x H) in cm (open)	109 x 50 x 124.5	98 x 50 x 124.5
Dimensions (W x D x H) in cm (closed)	76 x 50 x 99	66.5 x 50 x 99
Qt. master carton (units)	1	1
Optional cover	Classic S (2182039)	Classic S (2182039)

SUGGESTED ACCESSORIES



Classic Cover S

2182039
See page 70



Lava Rocks

205637
See page 68



3 in 1 Steel & Brass Bristled Brush

2000032608
See page 68



Premium Plancha Spatula

2000035410
See page 67



Stainless Steel Tongs

2000014567
See page 67



Premium Barbecue Glove

2000035057
See page 68

CAMPINGGAZ® FEATURES*



Aluminised steel burners



Integrated thermometer in lid improves heat monitoring



More cooking possibilities with a side burner that can be used with standard pots and pans.



Piezo ignition ensures convenient and matchless lighting



Side tables fold down for space saving storage



Number of people that can be served per grilling session

*Depending on model

ATTITUDE

The Campingaz[®] Attitude range of table top barbecues pairs sleek, urban styling with pioneering precision cooking, all within a compact, portable package. The new Campingaz[®] Attitude 2go brings BBQ pleasures to all who want to stay flexible.

Intuitively designed for effortless barbecuing, you benefit from even heat distribution thanks to the Campingaz[®] Blue Flame burner system.

The elegant lid of our Attitude 2100 models, opens to reveal a split cast iron grid and griddle, while the Culinary Modular Accessories allow you to unleash your cooking creativity with options from pizza to paella. When you're done, InstaClean[™] ensures cleaning couldn't be easier - parts just pop in the dishwasher.



CAMPINGAZ® CULINARY MODULARS



Campingaz® Culinary Modulares One System, Endless Possibilities!



Redefine urban outdoor cooking with Campingaz® Culinary Modular accessories and the Campingaz® Attitude!

Simply take out the inner ring of the cast iron modular and insert one of the various Campingaz® Culinary Modular Barbecue Accessories. (items sold separately - not compatible with Campingaz® Wok)

Cast Iron Culinary Modular Grid included on the Attitude 2100 LX and EX models.

EVEN TEMP™ TECHNOLOGY

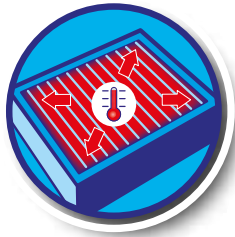

Even Temp™ Technology Guarantees Even Heat Distribution



Grill effectively and efficiently with our Even Temp™ Technology for perfectly even heat distribution

Campingaz® BBQs with Even Temp™ Technology cook your food evenly across the entire cooking surface of your barbecue.

Thanks to the patented Even Temp™ Technology, Campingaz® barbecues reach more than 250°C of the cooking surface.

This system is featured on all 4 & 3 Series, Attitude Barbecues, and Master Plancha and Blue Flame Planchas



ATTITUDE

Attitude 2100 LX

2000035660



BLUE FLAME
Performance & Efficiency



Perfectly even heat distribution enabled by durable Campingaz® Blue Flame burner system

Pre-assembled table top grill – no screwdriver required!

Blue Flame Burner design ensures efficient and economic gas consumption

Pioneering digital temperature display measures the heat on the cooking surface for perfect and precise heat management

Split cast iron grid and reversible griddle configuration offer all the right cooking surfaces to suit your BBQ favourites

Front loading grease tray and InstaClean™ dishwasher safe parts ensure quick and simple cleaning

Clever nickel chrome plated warming rack enables versatile and indirect grilling

10 year warranty on the die cast aluminum lid.



ATTITUDE

Attitude 2go CV

2000036952

3D



BLUE FLAME
Performance & Efficiency



Perfectly even heat distribution enabled by durable Campingaz® Blue Flame burner system

Pre-assembled table top grill – no screwdriver required!

Blue Flame Burner design ensures efficient and economic gas consumption

Front loading grease tray dishwasher part which ensures quick and simple cleaning

10 year warranty on the die cast aluminum lid

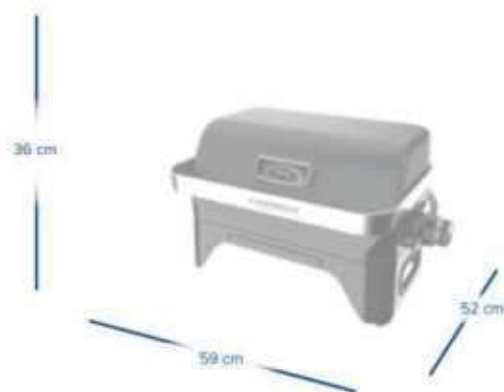

Patented Blue Flame Technology



CV cartridge and holder



Grease Tray



Piezo Ignition



ATTITUDE

3D



3D



Attitude 2100 LX

Attitude 2go CV

Reference	2000035660	2000036952
EAN code	3138522114282	3138522117917
Cooking surface (cm ²)	2100	1200
Cooking Dimensions (cm)	58 x 36	48 x 26 cm
Burner	Blue Flame Burner System (Aluminised Steel)	Blue Flame Burner System (Stainless steel)
Number of burners	2	1
Power	5 kW	2.4 kW
Cooking surface material	Enamelled cast iron	Enamelled cast iron
Cooking surface configuration	Modular Grid / Griddle	Grid
Warming Rack	-	-
Illuminated knobs	-	-
Ignition	Electronic ignition	Piezo
Thermometer	Yes	Yes
Lid material	Matt black die cast aluminium	Matt black die cast aluminium
Weight	24.5 kg	13 kg
Dimensions (W x D x H) in cm (open)	65 x 69 x 73	59 x 47 x 61
Dimensions (W x D x H) in cm (closed)	65 x 52 x 36	59 x 52 x 36 cm
QL master carton (units)	1	1
Optional cover	Attitude 2100 Premium Cover (2000035417)	Attitude 2go Premium Cover (2000037464)

SUGGESTED ACCESSORIES



Attitude 2100 Premium Cover
2000035417
See page 70



Culinary Modular Pizza Stone and Pizza Cutter
2000014582
See page 66



CV470 Plus
2179821
See page 75



Attitude 2go Premium Cover
2000037464
See page 70



3 in 1 Steel & Brass Bristled Brush
2000032608
See page 68



Premium Barbecue Glove
2000035057
See page 68

CAMPINGAZ® FEATURES*



Powerful patented Blue Flame burners for even heat distribution and great results with our Even Temp® Technology



10 year warranty on ton the die cast aluminium lid and 5 year warranty on grids and griddles



Campingaz® InstaClean™ System ensures quick and effortless cleaning



Number of people that can be served per grilling session



Experience various cooking and grilling options with the Campingaz® Culinary Modulares



No screwdriver required. All Attitude grills come completely pre-assembled.

*Depending on model

CAMPINGAZ®



A man in a white shirt and a woman in a striped shirt are sitting at a wooden table outdoors. The table is set with various dishes, including corn on the cob, bread, and meat. There are also grilling tools like tongs and a knife on the table. The background is a dark, textured wall.

Barbecue Accessories

Improve your grilling experience from cooking to cleaning, with our recommended accessories.

Easily upgrade your barbecue with our Culinary Modulares and transform traditional grilling into a discovery of new flavors.

OUR COOKING SURFACES

Campingaz® cooking surfaces are engineered to provide you with all the tools needed for successfully cooking any recipe on our barbecues.

From grids to griddles that protect the grilled food from direct exposure to flames and even heat distribution. You'll find that cooking, grilling, or even baking are possible with Campingaz's® multiple cooking surfaces.



Grid: Steaks, sausages or larger pieces of meat should be grilled on a grid. Especially, if you want to achieve the characteristic BBQ grid pattern.



Griddle: The griddle is mainly used for delicate grill items, such as fish, vegetables, fruits or strips of meat. A griddle protects the grill items from direct exposure to flames and distributes heat more evenly. Most of our cast iron griddles are reversible and have a flat and ridged side for multiple cooking options.



Warming Rack: Different foods take different lengths of time to cook. A warming rack is a smaller second grill that's positioned above the main grill. The warming rack can keep food that has already been cooked hot without cooking it further allowing other slower-cooking food to catch up. It can also be used as an additional grilling surface when using the barbecue like an oven for dishes such as stuffed tomatoes or baked potatoes.



Plancha: Plancha-style embraces low-fat, high-heat cooking on a flat surface for delicious and easy-made dishes in a southern European flair. Grill a steak to perfection with an accompanied sautéed sauce. Or cook some Huevos Rotos con tortas at your next dinner party, followed by caramelized bananas. Cleaning is simple on our enamelled cast iron griddle.



OUR COOKING MATERIALS

Campingaz® surface materials are engineered and tested to resist corrosion. In addition the materials used play a direct role in heat conduction and heat accumulation for even temperature distribution.



Enamelled Cast Iron: Enamelled cast iron grids and griddles conduct heat more intensively and sustainably than other materials. The pre-heating time of barbecues with cast iron cooking surfaces is slightly longer due to the thickness of the grids and griddles. The cast iron cooking surfaces are porcelain enamelled, protecting the cooking surface material from corrosion. They are produced in either a shiny/glossy look or in a textured, matte appearance. Grilled food doesn't stick as easily to the surface which aids cleaning and extends the lifetime of the cooking surface. We recommend to oil the cooking surface, regardless of the material, to avoid food from sticking to the surface.



Enamelled Stamped Steel Cooking Surfaces: These cooking surfaces are lightweight, easy to handle and easy to clean. The enamelling prevents residue from burning into the material and sticking to the cooking surface. They are dishwasher-safe, but can also be easily cleaned with a sponge and detergent.

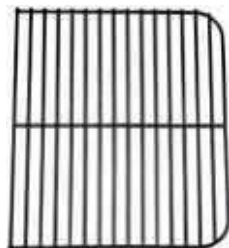

Enamelled Wire: Used on Xpert models and as warming rack in the Master Series. Compared to chromed wire grids, the Enamelled surface is easier to clean and protects the chrome. The grids are dishwasher-safe, but can also easily be cleaned with a sponge and detergent.



Chromed Wire: This material is often used for warming racks. The grids are very light but need special care as grill residues might burn into the material. Generally, chromed grids are dishwasher-safe, but we recommend a manual pre-cleaning with washing-up liquid and a sponge.



CAMPINGAZ® CULINARY MODULAR BARBECUE ACCESSORIES

Along with the Culinary Modular Cast Iron Grid, you have the ability to use all Culinary Modular cooking inserts listed below. Simply remove the inner ring for use with the Pizza Stone, Wok, Poultry Roaster, Paella Pan. Please see page 66 for more information.



Culinary Modular Pizza Stone and Pizza Cutter

Ref: 2000014582
EAN: 3138522069711

Compatible with Campingaz® Culinary Modular System. Serve up a pizza at your next barbecue! Simply roll the pizza dough onto the stainless steel plate & transfer to the ceramic pizza stone insert over the grill. Grill with lid closed for a perfect result! Please see page 12 & 15 for more information.



Culinary Modular Paella

Ref: 2000015104
EAN: 3138522071301

Compatible with Campingaz® Culinary Modular System. The stainless steel, non-stick coated modular Paella pan fits directly into your cast-iron grid to ensure that heat is distributed evenly. Please see page 12 & 15 for more information.



Culinary Modular Poultry Roaster

Ref: 2000014576
EAN: 3138522069650

Compatible with Campingaz® Culinary Modular System. Simply fill the inner compartment with your favorite cooking liquid: beer, wine, broth, or any combination of oils and seasoning and place poultry directly on top of the cylinder. Please see page 12 & 15 for more information.



All Campingaz® materials for cooking surfaces are certified to be used with food according to the EN 1935/2004. Additionally they have all passed a sensorial check to make sure that the material does not impact the taste of your recipe.



Stainless Steel Tongs

Ref: 2000014567
EAN: 3138522069568

The long handles of the tongs ensure you won't get any nasty burns and the serrated ends ensure a good grip while you easily and effortlessly turn food.



Premium Plancha Spatula

Ref: 2000035410
EAN: 3138522113858

Campingaz® stainless steel spatula with comfortable handle, specifically designed to easily mix vegetables, meat or seafood on your plancha or barbecue. Also aids plancha surface cleaning and removal of grill residue.



Culinary Modular Mandarin Wok

Ref: 2000038449
EAN: 3138522122720

Compatible with Campingaz® Culinary Modular System.

Carbon steel wok with non-stick coating, perfect for Asian dishes made directly on the grill. Please see page 13 for more information.

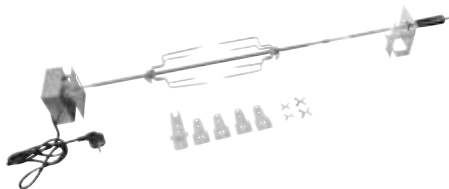

Premium Rotisserie Kit

Ref: 2181640
EAN: 3138522128654

Compatible with all Campingaz® 3&4 burner barbecues (excl. Adelaide & 4 Series RBS)

Kit composed of 1 electric motor, 1 spit, and two double forks. The heavy duty kit is dedicated to rotisserie cooking lovers. Its heavy duty spit and forks support a weight up to 3 kilograms!



BARBECUE ACCESSORIES

Benefit from Campingaz®'s barbecue upgrades and replacement burner covers, grids, and InstaClean™ kits to bring new life into your loved barbecue.



3 in 1 Brush

Ref: 2000032608
EAN: 3138522104078

One brush for three actions: scraping off grease with the metal scraper, rubbing away sticky food with the abrasive nylon pad and cleaning between the grill grates with the strong, brass bristled brush. Sold in 18 piece PDQ



Premium Barbecue Glove

Ref: 2000035057
EAN: 3138522112349

Give your hand full mobility with a glove that can withstand heat up to 350°C. Use the Premium Barbecue Glove to easily lift modular units in and out of your barbecue (culinary modulars found on page 48)



Genuine Lava Rocks

Ref: 205637
EAN: 3138522056377

- Replacement pack
- Natural product with a porous surface
- Sufficient for a 1500cm² cooking surface



BARBECUE ACCESSORIES

Grilling multiple burgers, sausages or fish at the same time? Simplify rotating food and avoid singed arms with these handy grids and baskets.

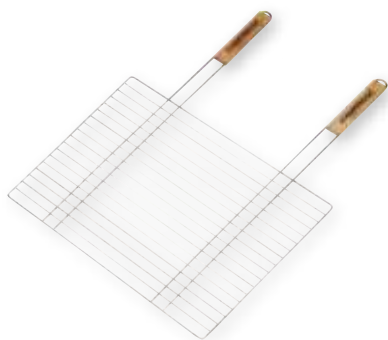

Rectangular Single Grid Basket

Ref: 205704 53x39cm
EAN: 3138522057046

Chrome plated double grid with wooden handles.



Double Grid Basket

Ref: 205703 40x29cm
EAN:3138522057039

Chrome plated grid with wooden handle.



PREMIUM BARBECUE COVERS

These covers don't just keep the rain out, they force condensation out too, using our water-resistant, breathable technology. Combine that with an included storage bag, and you've got a compact, unobtrusive and highly effective range of covers.

XL Cover

Ref: 2000037292
EAN: 3138522119331

Dimensions: 159 x 65 x 118 cm

L Cover

Ref: 2000037291
EAN: 3138522119324

Dimensions: 146 x 65 x 118 cm

M Cover

Ref: 2000037290
EAN: 3138522119317

Dimensions: 136 x 62 x 102 cm

Attitude 2100 Cover

Ref: 2000035417
EAN: 3138522113926

Dimensions: 66 x 51 x 35 cm

Attitude 2go

Ref: 2000037464
EAN: 3138522119799

Dimensions: 59 x 39 x 36 cm



CLASSIC BARBECUE COVERS

Covers to fit to wide range of Campingaz® barbecues, resistant to sun, rain and cold. Made of polyester, a robust, PVC-free high quality material providing your barbecue with great coverage.

XL Cover

Ref: 2000037297
EAN: 3138522119386

Dimensions: 159 x 65 x 118 cm

L Cover

Ref: 2000037296
EAN: 3138522119379

Dimensions: 146 x 65 x 118 cm



M Cover

Ref: 2000037295
EAN: 3138522119362

Dimensions: 136 x 62 x 102 cm

S Cover

Ref: 2182039
EAN: 3138522128845

Dimensions: 122 x 62 x 102 cm

- Material: Black polyester 200 D
- Ties and cord locks for secure fitting

Barbecue Accessories

COMPATIBILITY OF BARBECUE COVERS

		PREMIUM COVERS					CLASSIC BARBECUE COVERS			
		M	L	XL	Attitude 2100	Attitude 2go	S	M	L	XL
SKU		2000037290	2000037291	2000037292	2000035417	2000037464	2182039	2000037295	2000037296	2000037297
Dimensions (LxWxH) in cm		136x62x102	146x65x118	159x65x118	66x51x35	59x39x36	122x62x102	136x62x102	146x65x118	159x65x118
Attitude	Attitude 2 Go					✓				
	Attitude 2100 LX				✓					
2-Series	Classic L, EXS Vario	✓						✓		
3-Series	Woody or Classic L, LS, LS Plus, LX, Premium		✓						✓	
4-Series	Woody or Classic L, L Plus, LS, LS Plus, LX, LXS, Premium S, Onyx S			✓						✓
Xpert Series	Xpert 100 L, Xpert 200 L						✓			



CAMPINGAZ®

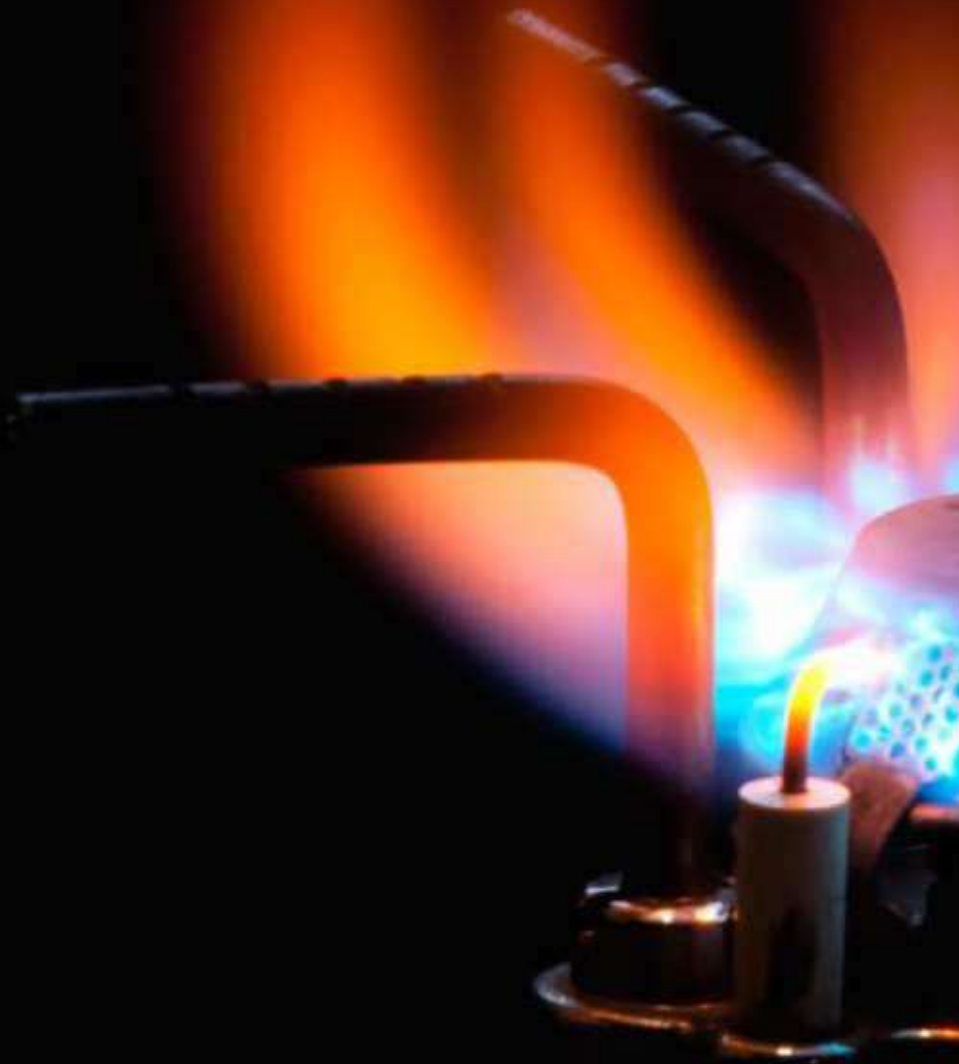



Cartridges

Energy for your outdoor-living!

Powerful & convenient.

From lightweight stoves on backpacking adventures to powerful cookers at your favourite campsite; from gardening equipment to your hobby or DIY devices; our cartridges are your source of energy. Easy to handle, safe and efficient!

WHY YOU CAN RELY ON CAMPINGAZ®

Campingaz® is one of the European pioneers when it comes to portable energy solutions. Since 1949 Campingaz® branded products enable people to enjoy living and cooking outdoors.

The Campingaz® cartridges

- Available as Butane and Butane/Propane blend
- Available as a pierceable cartridge with innovative Gas Lock system (as of 2014)
- 100% quality controlled in Europe
- Available with the patented Easy Clic™ Plus valve system for utmost consumer comfort
- Dedicated cartridge solutions for distinct products like table top stoves and DIY tools
- Available all over Europe and beyond



With Campingaz® you never run out of gas!

CHOOSE THE RIGHT GAS...



Valve cartridges

Featuring a self-sealing valve, they can be disconnected and reconnected even when not empty!



Pierceable cartridges

Economical single use cartridges that cannot be disconnected from a product until the cartridge is empty.

2 SECURE CONNECTION TYPES



Easy Clic™ Plus

An even more convenient system made for valve cartridges – simply rotate 45° to get connected!

The Easy Clic™ Plus connection is the most simple and technically sophisticated connection which allows the fixing of a valve cartridge on a stove or on a lantern with a simple 45° rotation.



1- Fix

Applying a small amount of pressure on the device with the cartridge is enough



2- Turn

Apply a 45° left turn on the device and you're connected!



Screw in system for the cylinder connection



1- Insert

Insert the device in the valve head of the cylinder



2- Turn

Turn right to screw it in and connect, turn left to unscrew

Butane/Propane mix
Recommended for better performance
at low temperatures.



VALVE CARTRIDGES

Our range of valve cartridges have a high security self-sealing valve giving them all the advantages of being resealable – so they can be disconnected and reconnected even when they're not empty. Ideal for periodic, moderate use.

Butane/Propane mix

Recommended for better performance at low temperatures.



CV300 Plus

2179842
3138522128135

Contains 240g Butane/Propane mix (80/20)

Size (without cap) ø 9 x 10.5 cm

Weight 410 g



CV470 Plus

2179821
3138522128111

Contains 450g Butane/Propane mix (80/20)

Size (without cap) ø 11 x 14 cm

Weight 710 g



CP250

For Bistro™ type stoves
2000033971
3138522109271

Contains 220g of Butane/Isobutane mix

Size (without cap) ø 6.9 x 18 cm

Weight 315 g

* Not Made In France

PIERCEABLE CARTRIDGES



Pierceable cartridges can't be disconnected once they've been plugged into an appliance, so they're suitable for more intensive or longer use – they're also our most economical and widely available cartridges.

C206 GLS

The cartridge has an integrated leakage limiter, the Gas Lock System, which is compliant to the European standard EN 417:2012 legislation. The system prevents the majority of residual gas from escaping the cartridge when accidentally disconnecting it from the appliance, thereby also preventing flare-ups.



C206 GLS

3000002290 - Butane
3138522069179

Ref: 3000002295 - Butane/Propane mix
3138522069216

Contains 190g Butane or Butane/Propane mix (80/20)

Size ø 9 x 9.5 cm

Weight 280 g



C206

3000006403 - Butane
3138520182009

Contains 190g Butane

Size ø 9 x 9.5 cm

Weight 280 g

This C206 cartridge does not include the Gas Lock System and will be kept available only for markets not following the EN417:2012 standard.



A person in a floral dress stands on a balcony with a grill and food. The balcony has a metal railing and a view of a city with trees and buildings under a blue sky with clouds. The person is holding a wooden spatula. On the balcony, there is a grill with a plate of food, a bowl, a glass of water, and a small jar. The background shows a cityscape with trees and buildings under a blue sky with clouds.

Versatile Urban & Caravan Grilling

Whether you are looking for a space saving grill for your city balcony or practical cooking gear for your caravan kit, we've got the right grills for you.

Explore our wide range of grill and stove combos perfect for small urban outdoor spaces or cozy evenings while on a caravanning adventure. All grills and stoves are supported by our globally available range of gas cartridges and cylinders. Whichever you choose, you can be sure that they're reliable, safe and practical.

MULTI-COOKING OPTIONS

The Campingaz® cooking world - a world of multi-cooking options!

Whether camping with family and friends, for long or short periods, for a day on the beach or a simple picnic in a park, Campingaz® offers a wide range of portable stoves that enable all cooking possibilities. There is no need to compromise, even when outdoors, you have all the options to prepare your favourite meals, like at home.

Why not prepare an English breakfast with beans, sausages and toast? Or perhaps grill some fresh fish whilst cooking some pasta? Alternatively, you may prefer to bake a pizza? All these tasty dishes are possible with the Campingaz® gas stove range.

Cooking



Grilling



Toasting



Spit style roasting



CHOOSE THE RIGHT STOVE...

Make sure you choose the right stove for your needs.

1. Cartridge or cylinder?

Cylinder stoves are designed to run for much longer and produce more power for intensive use. Refillable cylinders are heavy and not very practical if you're going hiking. For portability, a cartridge stove is the way to go! Each of our two burner cylinder stoves can run off either Campingaz® R904/907 gas cylinders or any standard butane or propane 6kg gas cylinder.

2. Single or multi-burner?

A single-burner stove is lighter and more compact but only allows you to cook one thing at a time. Two burner stoves give you more options for your cooking and often come with a stand but can be a little less handy and more heavy than a single-burner stove.

3. Burner and grill?

Ask yourself what kind of cooking you would like to do. If you intend on mainly making a cup of tea or heating baked beans, one burner may be enough. If you want to cook a full breakfast, consider a burner and grill combination.

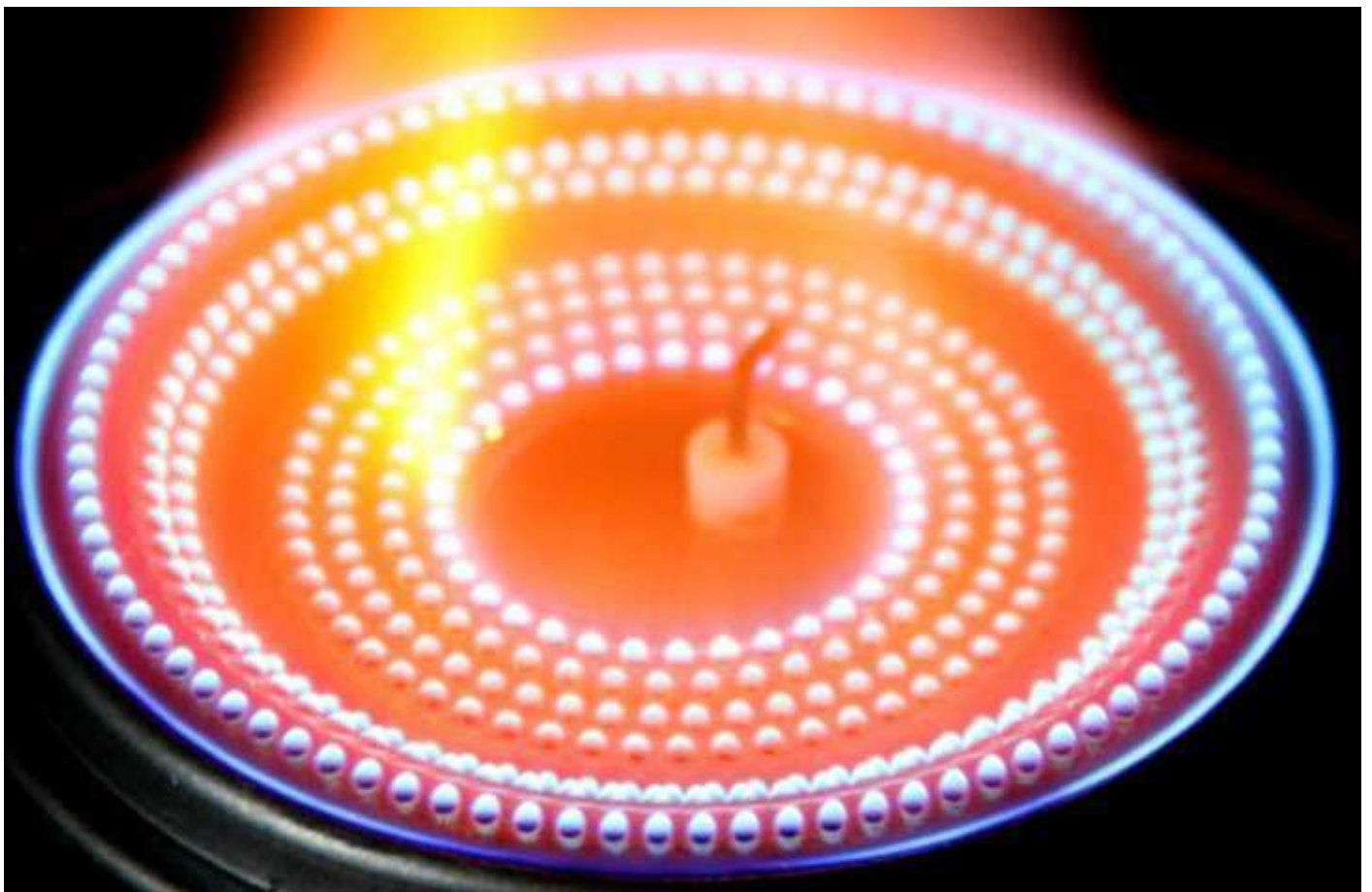

360 GRILL RANGE

Introducing the very first table-top style gas grill with a flat design that can be grilled on from 360° while comfortably sitting at the table. The Campinggaz® 360 Grill offers extensive grilling and cooking versatility with an included ribbed griddle, flat plancha as well as a pan support for stove cooking. The practical grill

comes completely pre-assembled and the sexy, yet simple design ensures it will harmoniously integrate into both close to home urban settings as well as on any caravan adventure. Light, compact and convenient to take along with you wherever the road takes you.



Reference
EAN
Country cluster
Power
Burner technology
Cooking dimension/size
Configuration
Cooking material
Ignition
Gas consumption
Usage & run time
Fuel source
Carry & storage bag
Dimensions (LxWxH)
Weight
Qt. Master carton

360 Grill CV
2000038776 (Anthracite)
3138522124540
FR/ES/PT/DE/IT/CZ/SK/RO/HR/PL/SI/HU/BG/LT/LV/EE/NL/NO/SE/DK/FI/IS/GR/GB/AR/RU
2400W
360 ring burner
30cm Ø
Reversible griddle + pan support
Non-stick die-casted aluminium
Push N Turn ignition
175 g/h
2 hrs & 30mins on CV470
Campinggaz CV 470 cartridges
Included
Material: Polyester
35 x 35 x 16 cm
5.1 kg
1

360 Grill CV
2000038778 (Copper)
3138522124564
FR/ES/PT/DE/IT/CZ/SK/RO/HR/PL/SI/HU/BG/LT/LV/EE/NL/NO/SE/DK/FI/IS/GR/GB/AR/RU
2400W
360 ring burner
30cm Ø
Reversible griddle + pan support
Non-stick die-casted aluminium
Push N Turn ignition
175 g/h
2 hrs & 30mins on CV470
Campinggaz CV 470 cartridges
Included
Material: Polyester
35 x 35 x 16 cm
5.1 kg
1

CAMPINGGAZ® FEATURES*



Easy Clic™ Plus: Simple method for attaching a valve cartridge



Power adjustable: Fully adjustable power.



No assembly required



3 year warranty on lid, stainless steel burners and on cast iron grids and griddles



Push & Turn Piezo ignition



Easy clean: Can be washed and cleaned easily.



Convenient cartridge table support



Easy to clean



Fully adjustable power



Integrated EasyClic™ Plus system for easy connection and disconnection of cartridge



PARTY GRILL™ RANGE

Cooking on the go, on your balcony or wherever you go was never so easy. The Party Grill™ 400 and 200 is available in different powers, sizes and gas formats. The models feature multiple cooking surfaces including a direct stove for pan cooking, grill, griddle, plancha,

and the lid even doubles as a wok or oven*. Lighting the stove is simple, based on the piezo ignition and cleaning the grill is easy thanks to its collect and tip-away cleaning system.

**Not all models feature all cooking surfaces.*



	Party Grill™ 400	Party Grill™ 200	Party Grill™
Reference	2000035499	2000023716	203403
EAN	3138522085124	3138522085100	3138522034030
Country cluster	GB-FR-DE-NL-IT-ES-PT-FI-DK-SE-NO-GR-PL-SI-CZ-SK-RO-EE-AR	FR-GB-DE-AT-IT-ES-PT-BE-NL-LU-CH-SE-NO-DK-FI-CZ-IE-SK-PL-EE-SI-GR-AR-TR	GB-FR-DE-NL-SE-IT-ES-PT-TR-CZ-PL-SI-HU-RU-BG-RO-SK-HR
Power	2000 W	2000 W	1350 W
Gas consumption	145 g/h	145 g/h	99 g/h
Boil time	6 min 5 sec	4 min 18 sec	5 min 40 s
Ignition	Push & Turn Piezo	Piezo	Piezo
Runtime	19 hrs and 30 min. on R907 12 hrs and 30 min. on R904	3 hrs on CV470 1 hr and 40 min on CV300	4 hrs and 30 min on CV470 2 hrs and 40 min on CV300
Fuel source	R904, R907, butane or propane cylinder	CV470+ CV300+	CV470+ CV300+
Weight	4.92 kg	2.84 kg	2.3kg
Dimensions (LxWxH)	Ø 36 x 42 cm (on stand)	Ø 32 x 33 cm	Ø 32 x 25 cm
Carry Bag	Included. Material: Polyester	Not Included	Not Included
Qt. Master carton	2	4	5

CAMPINGGAZ® FEATURES*



Easy Clic™ Plus: Simple method for attaching a valve cartridge



Grease collecting: Grease collecting system for healthier cooking.



Push & Turn Piezo ignition



Easy clean: Can be washed and cleaned easily.



Power adjustable: Fully adjustable power.



Non-stick cooking surface



Fully adjustable power



Fully adjustable power



Integrated EasyClic™ Plus system for easy connection and disconnection of cartridge



CAMPING KITCHEN™ 2 SERIES

Gives you space to cook for all family and friends...



Easy to set up...

To ignite...



To clean...

And to carry.



EVEN TEMP™ TECHNOLOGY

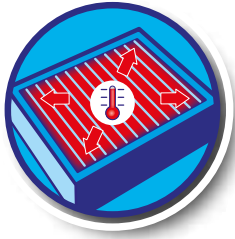

Even Temp™ Technology Guarantees Even Heat Distribution



Grill effectively and efficiently with our Even Temp™ Technology for perfectly even heat distribution

The Camping Kitchen 2 Grill & Go with Even Temp™ Technology cook your food evenly across the entire cooking surface. Thanks to

the Even Temp™ Technology, griddles reach more than 250°C on the cooking surface.



**Heat distribution testing done per internal process*

CAMPING KITCHEN™ 2

Camping Kitchen™ 2 Multi-Cook

2197176

NEW



With Flame Guard™ technology you'll get cooking fast under windy conditions. 1 liter of water achieves 90 degrees celsius boiling time, with up to 3m/s wind, in under 12 minutes.

The new Flame Guard™ technology is designed for optimal flame protection and less gas consumption.



Flame Guard™ technology for **optimal flame protection** even with wind up to 3m/s

Independent **piezo ignition**

Compact, all-in-one portable stove

Optimal heat diffusion with tube burner set along entire width of the die-casted aluminum griddle

Removable pan supports for quick and **easy cleaning**

3 cooking zones with **individual heat control**



Food Preparation

The Camping Kitchen™ 2 Multi-Cook stove combines cooking and grilling in one, with three independent burners allowing to individually control your heat. Simultaneously boil, saute', and toast for a hot and timely served meal. Even when the weather is unpredictable, the burners' Flame Guard™ Technology is designed for optimal flame protection for the best outdoor cooking

experience. Not only is cooking all-in-one, but so is portability. With reinforced hinges connecting the lid to base, the entire stove becomes its own case for clean and quick packing before and after your trip. Pan supports and grilling plate are all removable for easy clean-up.

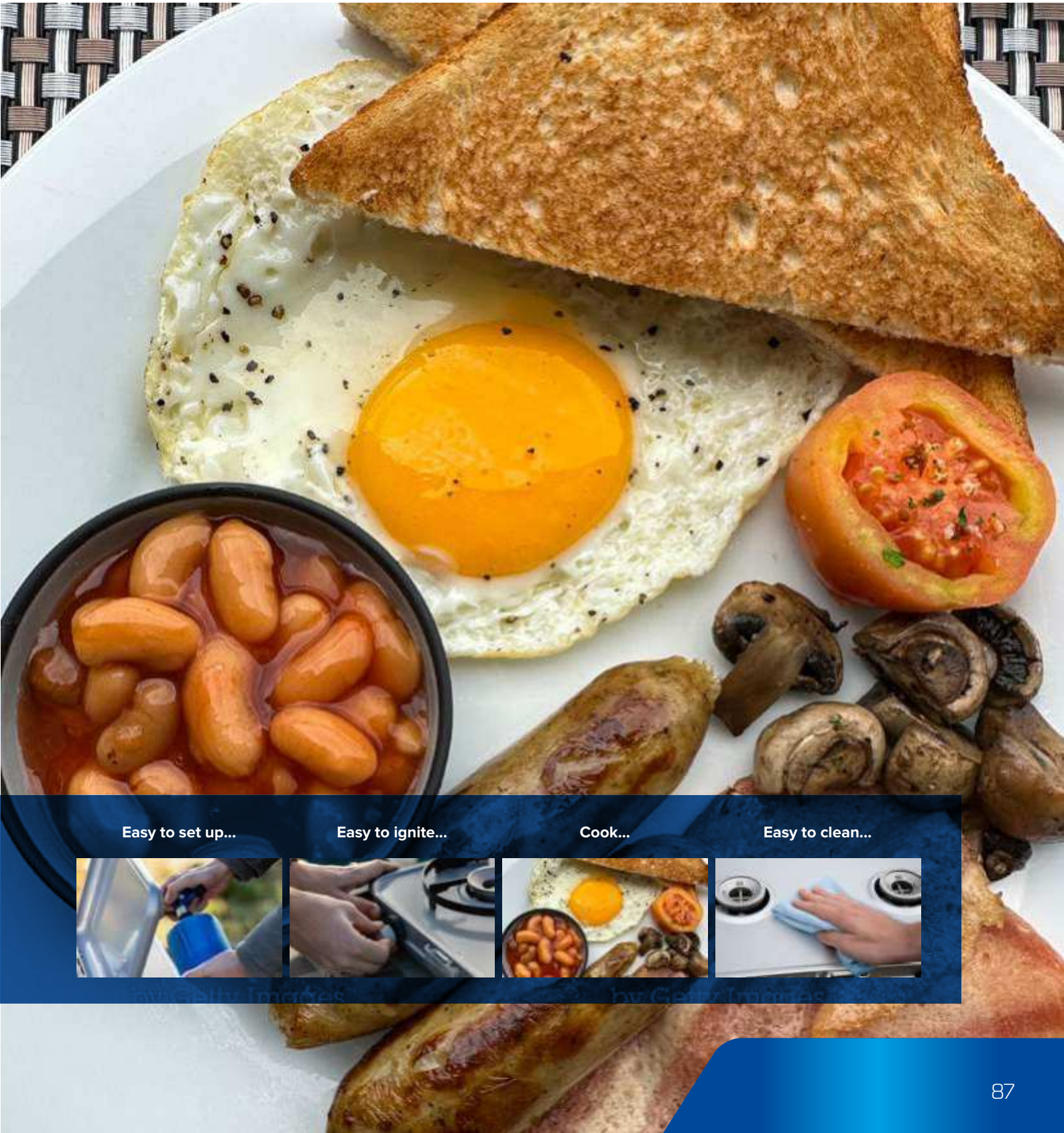

Easy to set up...

Easy to ignite...

Cook...

Easy to clean...



by Getty Images

by Getty Images

CAMPING KITCHEN™ 2

Camping Kitchen™ 2 Maxi

NEW

2197173



With Flame Guard™ technology you'll get cooking fast under windy conditions. 1 liter of water achieves 90 degrees celsius boiling time, with up to 3m/s wind, in under 12 minutes.

The new Flame Guard™ technology is designed for optimal flame protection and less gas consumption.



Flame Guard™ Technology for **optimal flame protection** even with wind up to 3m/s

Large cook-top for pans & pots up to **28cm Ø**

Independent **piezo ignition**

Compact, all-in-one portable stove

Removable pan supports for quick and **easy cleaning**



Food Preparation

The Camping Kitchen™ 2 Maxi stove features two independent burners to individually control your heat. When cooking for larger families or groups, the large pan supports allowing up to 28 cm offer flexibility to use your everyday kitchen pots and pans. Even when the weather is unpredictable, the burners' Flame Guard™ Technology is designed for optimal flame protection for

the best outdoor cooking experience. With reinforced hinges connecting the lid to base, the entire stove becomes its own case for clean and quick packing, before and after your trip. Pan supports are removable for easy clean-up at the campsite.



Easy to set up...



Easy to ignite...



Cook...



Easy to clean...



CAMPING KITCHEN™ 2



NEW



NEW

	Camping Kitchen™ 2 Multi-Cook	Camping Kitchen™ 2 Maxi
Fuel Source	Only Cylinders	Cartridges CV470 or Cylinders
Sku	2197176	CV: 2197172
Ignition	Piezo ignition (incl. tube burner)	Piezo ignition
Pressure	Regulated pressure	Direct and regulated pressure
Material	Body in painted steel High temperature paint	Body in painted steel High temperature paint
Pan support material	Enameled steel (black)	Enameled steel (black)
Max pans & pots Ø	20 cm	28 cm
Griddle material	Die casted aluminium Non-stick PTFE coating	-
Grilling surface dimension	14 x 24,5 cm	-
Valve / Knobs	3	2
Dimensions closed (LxWxH)	60 x 35 x 10.8 cm	53 x 36 x 10.8 cm
Dimensions open (LxWxH)	60 x 38.8 x 36 cm	53 x 40 x 38.8 cm
Product Weight	5,4 kg	4,4 kg

SUGGESTED ACCESSORIES



Camping Kit

2197185
See page 102



Kettle

2197186
See page 102



Trekking Kit

2197184
See page 102

CAMPINGGAZ® FEATURES*



Integrated windshield system



Easy clean: Can be washed and cleaned easily.



The new FLAMEGUARD technology is designed for optimal flame protection and less gas consumption.



Independent piezo ignition



Large cook-top for pans & pots up to 28 cm Ø*



Easy closing lid with all elements inside for carefree transportation

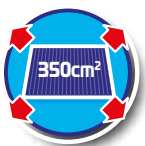

350 cm² GRIDDLE : grill and toast**

*Only available on the Camping Kitchen™ 2 Maxi

** Only available on the Camping Kitchen™ 2 Multi-Cook

CAMPING KITCHEN™ 2

The Camping Kitchen™ 2 is the perfect companion stove for any family trip, either for a quick weekend away or for a longer stay. Campinggaz® Camping Kitchen™ 2 is a light and easily portable, two burner stove that is available

both in a cartridge and cylinder version depending on the length of your vacation. It also features heat resistant side panels with enameled steel pan supports that doubles as wind protection.



	Camping Kitchen™ 2	Camping Kitchen™ 2 CV	Camping Kitchen™ 2 CV PZ
Reference	2000035521	2000035522	2000035941
EAN code	3138522114015	3138522114022	3138522114749
Power	2 x 2000W	2 x 2000W	2 x 2000W
Gas consumption	2 x 145 g/h	2 x 145 g/h	2 x 145 g/h
Boil time	5 min 45 sec	6 min 30 sec	6 min 30 sec
Ignition	Manual	Manual	Piezo
Runtime	9 h 30 min on R907 6 h 10 min on R904	1h30m on CV470 +	1h30m on CV470 +
Lid material	Painted Steel	Painted Steel	Painted Steel
Fuel source	R904, R907, Butane or Propane Cylinder	CV 470+	CV 470+
Weight	3.5 kg	3.8 kg	3.8 kg
Dimensions open (LxWxH)	49 x 38 x 35 cm	49 x 45 x 33 cm	49 x 45 x 33 cm
Dimensions closed (LxWxH)	49 x 35 x 10 cm	49 x 35 x 10 cm	49 x 35 x 10 cm
Qt. Master carton (units)	5	5	5

CAMPINGGAZ® FEATURES*



Regulator and hose included



Easy to carry: Convenient carrying and easy storage.



Easy Clic™ Plus: Simple method for attaching a valve cartridge



Two burner stove with two powerful burners



Easy clean: Can be washed and cleaned easily.



Power adjustable: Fully adjustable power.

CAMPING KITCHEN™ 2 GRILL & GO

The new Camping Kitchen™ 2 Grill & Go is a compact and versatile cooking & grilling companion. The 2 burner stove with interchangeable searing grids and plancha gives you the flexibility to support all food preparation

needs. Whether life takes you on an adventure or relaxing with family and friends in the comfort of your home, the carefully designed carry bag gives you the ability to cater when grilling inspiration hits.



	Camping Kitchen™ 2 Grill & Go CV	Camping Kitchen™ 2 Grill & Go
Reference	2176805	2181856
EAN code	3138522127800	3138522128760
Power	4000 W	4000 W
Gas consumption	2 x 145 g/h	2 x 145 g/h
Boil time	6 min 30 s	5 min 45 s
Ignition	Piezo	Piezo
Runtime	1 h 30 m on CV470 +	9 h 30 min on R907 6 h 10 min on R904
Fuel source	CV 470 +	R904, R907, Butane or Propane Cylinder
Weight	5.5 kg	5.3 kg
Dimensions open (LxWxH)	49 x 38 x 35 cm	49 x 38 x 35 cm
Dimensions closed (LxWxH)	49 x 35 x 10 cm	49 x 35 x 10 cm
Qt. Master carton (units)	3	3

CAMPINGGAZ® FEATURES*



Regulator and hose included



Independent piezo ignition



Easy Clic™ Plus: Simple method for attaching a valve cartridge



Even Temp™ Technology: Even heat distribution across the entire cooking surface



Easy clean: Can be washed and cleaned easily

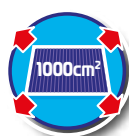

1000 cm² cooking surface



Easy to carry: Convenient carrying and easy storage



Two burner stove with two powerful burners

CAMPING COOK CV

The Camping Cook is a great entry stove for those first time campers. This robust, no frills, camping stove offers excellent performance and portability. No need for any setup or additional accessories as the hose and

regulator already come firmly attached. Simply connect your easy clic cartridge and you are good to go. With two 1800W independently adjustable burners you can cook up a meal for friends and family in no time.



Camping Cook CV

Reference	2000037217
EAN code	3138522118815
Country Cluster	FR-GB-DE-ES-PT-IT-NL-NO-SE-FI-DK-PL-CZ-SK-HU-SI-HR-RO-BG-EE-LT-LV
Power	3600 W
Gas consumption	261 g/h
Boil time	6 m 45 s
Ignition	Manual
Runtime	1 h 40 min on CV470
Lid material	TBC
Fuel source	CV470
Weight	1.9kg
Dimensions open (LxWxH)	45 x 30 x 9.6 cm
Dimensions closed (LxWxH)	45 x 30 x 9.6 cm
Qt. Master carton (units)	5

Hose and regulator with easy clic connection comes included and attached

Two removable, dishwasher-safe pan supports

Push and turn knobs for full flame control

CAMPINGGAZ® FEATURES*



Regulator and hose included



Two burner stove with two powerful burners



Easy Clic™ Plus: Simple method for attaching a valve cartridge



Power adjustable: Fully adjustable power.



Easy clean: Can be washed and cleaned easily.



CAMP' BISTRO STOVES



	Camp' Bistro 3	Camp' Bistro 2
Reference	2000038753	2000030424
EAN Code	3138522124403	3138522095376
Country Clusters	FR-GB-NL-DE-IT-ES-PT-DK-NO-SE-FI-CZ-PL-HU-SI-SK-HR-EE-LT-LV-GR-RO-BG-IS	FR, GB, DE, NL, IT, ES, PT, SE, NO, DK, FI, GR, PL, SK, SI, HU, HR, CZ, RU, AE, RO, BG, TR
Power	2200W	2200 W
Gas Consumption	160g/h	160 g/h
Outdoor boiling time	6 min 25 s	5m30s
Ignition	Integrated piezo	Integrated piezo
Runtime	1h20	1 hr 15 min
Fuel source	CP 250	CP250
Valve / Knobs	Progressive opening	Progressive opening
Dimensions	34,3 x 28,4 x 13,3	33 x 28 x 9 cm
Product Weight	1,6 kg	1,43kg
Accessories	Carry Case	Carry Case
Qt. Master carton	6	6

CAMPINGAZ® FEATURES*



Power adjustable: Fully adjustable power.



Easy to carry: Convenient carrying and easy storage.



Push & Turn Piezo ignition



Valve cartridge CP250



Easy clean: Can be washed and cleaned easily.



Stopgaz System The Stopgaz System is a built-in flame safety device that stops gas from flowing when there is no flame. This feature is included in the 2000039195 Camp'Bistro DLX Stopgaz version.



BISTRO™ GRILL

Bistro™ Grill

NEW

2197182



Grilling surface: 1000 cm², die casted aluminum with non-stick coating

Removable components for easy cleaning : griddle, grease tray and grease drainer.

Piezo ignition with **heat**

Over 1.5 hours of cooking time with **CP250** (max. power)

Dual **safety system**

Pre-assembled: Ready to grill after 6 minutes preheating



Hard plastic carry case included



Food Preparation

The legendary Bistro™ is making an entrance in the extra-mobile barbecue world, to be your grilling companion for every occasion: at home on your balcony or in your garden; camping or on the road. The new Bistro Grill, with its large non-stick grilling surface, needs only 6 minutes to preheat and you're ready to start cooking. The grilling plate offers a ridged surface for cooking

grease to flow downward and into a removable, grease tray. The grill runs on a CP250 gas cartridge and has a dual safety system installed to cut the gas flow and disconnect the cartridge in case of any overheating. Packing for travel will remain hassle-free with its 100% recycled plastic, travel case, keeping all components organized.



BISTRO™ GRILL

NEW



BISTRO™ GRILL

Reference	2197182
EAN Code	3138522131968
Country Clusters	GB-IE-FR-BEL-DE-AT-IT-MLT-ES- PT-NL-DK-LUX- CH-SE-NO-FI-GR-CYP-CZ-SK-EE-ARA-ZA
Power	2000W
Gas Consumption	140g/h
Outdoor boiling time	
Ignition	Piezo ignition
Pressure	Direct pressure
Material	Body in painted steel / Firebox in zinc plated steel
Griddle material	Die casted aluminum with non-stick coating
Grilling surface dimensions	33.5 x 28 cm
Cooking surface	940cm ²
Runtime	1h 30m
Fuel source	Cartridges CP250
Valve / Knobs	1
Dimensions	43 x 28 x 11 cm
Product Weight	5,2 kg
Accessories	Carry Case Included
Qt. Master carton	3

SUGGESTED ACCESSORIES



CP 250 cartridge

2000033971
See page 75

CAMPINGAZ® FEATURES*

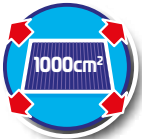

Grilling surface: 1000 cm²



No assembly required



Grease collecting tray for healthier cooking



Independent piezo ignition



100% recycled hard plastic carry case All our Bistro stove are delivered with a transport and storage carry case, made out of 100% recycled plastic.



Power adjustable: Fully adjustable power.

CAMPING COOKING ACCESSORIES



NEW



NEW



NEW

	Camping Kit	Trekking Kit	Kettle
Reference	2197185	2197184	2197186
Composition	2x Pots + 2x Lids + 1x Pan	1x Pot + 1x Lid + 1x Pan	1x Kettle
Material	Stainless Steel (AISI 304) + handle silicone	Stainless Steel (AISI 304) + handle silicone	Stainless Steel (AISI 304) + handle silicone
Dimensions	Pots: 18 X 9 and 16 X 8 cm Pan : 17.5 x 4 cm	Pot: 14.5 x 6.5 cm Pan: 15.5 x 3 cm	1,5L

COLEMAN® COOKING STAND

NEW

For the ultimate European Camper, the Cooking Stand kitchen designed by Coleman®, but with Campinggaz® stoves in mind. The Cooking Stand portable kitchen is your compact kitchen companion with all the features needed to set-up your kitchen. Easily folds and portable, the Cooking Stand features standard counter height for cooking comfortably with your stove, plus a bottom shelf to hold either a cylinder or cooking supplies. An easily accessible hanging trash bag compartment and an additional gas cartridge holder is integrated into the fold-out Cooking Stand. The attached, and sturdy side table makes cooking convenient from food prepping, directly to cooking on the stove-top. The side table has a protective antimicrobial lining to prevent bacterial growth, mould, and mildew. A hanging textile cupboard with shelving attachment to store additional cooking or food supplies keeps your campsite organized and tidy.



Coleman® Cooking Stand

SKU	2199743
EAN code	3138522132248
Open size	141 x 60 x 98.5 cm
Folded size	80 x 48 x 14 cm
Material - Table top	Top & Middle table - Steel (Side Table Aluminium)
Material - frame	Steel
Product weight	14.5 kg
Carry bag	Yes
Features	Cartridge & Cylinder storage, Storage Cupboard, Food Prep Area, Waste bin Holder

CAMPINGGAZ® COMPATIBLE STOVES

Camping Chef	✓	Camping Kitchen™ 2 MAXI CV	✓
Camping Chef CV	✓	Camping Kitchen™ 2 Multi-Cook	✓
Camping Cook CV	✓	Base Camp	✓
100 S CV Kit	✓	3-in-One	✓
200 S	✓	Camp Bistro range	✓
400 S	✓	3-in-One CV	✓
400 S Kit	✓	360 Grill	✓
400 SG/600 SV	✓	360 Grill CV	✓
400 ST	✓	Bistro™ Grill	✓
Camping Kitchen™ 2	✓	Tour & Grill (without windshield)	✓
Camping Kitchen™ 2 CV	✓	Attitude 2 GO (without windshield)	✓
Camping Kitchen™ 2 MAXI	✓	Attitude 2 GO CV (without windshield)	✓



CARTRIDGE & CYLINDER STOVES



Bivouac™

203044

3138522030445

AT-BE-CH-DK-DE-ES-FI-FR-GR-IE-IT-LU-NL-NO-SE-PT-MEA

2600 W

190 g/h

3 min 10 s

Piezo

1 hr 15 min on CV300+
2 hrs 20 min on CV470+

CV300+, CV470+

950g

Ø 17.5 x 24 cm

Included. Material: Polyester

6



Twister™ Plus PZ

204190

33138522041908

AT-CH-DE-ES-FR-IT-GR-PT-TR-MEA

2900 W

210 g/h

3 min 45 s

Piezo

1 hr 10 min on CV300+
2 hrs on CV470+

CV300+, CV470+

215g

Ø 12 x 11 cm

-

10

Reference
EAN code
Country cluster
Power
Gas consumption
Boil time
Ignition
Runtime
Fuel source
Weight
Dimensions (LxWxH)
Carry Bag
Qt. Master carton



Bleuët™ Micro Plus

204184

3138522041847

BE-DK-FI-GB-IE-LU-NL-NO-SE-IS

1250 W

90 g/h

5 min 30 s

Manual ignition

2 hrs 40 min on CV300+
5 hrs on CV470+

CV300+, CV470+

175g

Ø 13 x 9 cm

24

2184543

3138522129040

FR-DE-AT-IT-ES-PT-CH-GR-RU-CZ-CR-HU-SL-PL-SK-RO-BG-EE-LT-LAV-TR



Camping 206 S

40470

5012832549324

FR-DE-AT-IT-ES-PT-BE-NL-LU-CH-CZ-HU-PL-IE-MEA-RUS

1250 W

90 g/h

5 min 30 s

Manual ignition

2 hrs

C206GLS

280g

Ø 13.5 x 19 cm

10

Reference
EAN code
Country cluster
Power
Gas consumption
Boil time
Ignition
Runtime
Fuel source
Weight
Dimensions (LxWxH)
Qt. Master carton

CYLINDER STOVES

Robust stoves designed to hold large, heavy pans and to operate for longer periods using Campingaz® R904 and R907 refillable cylinders. Easy to use, they screw directly onto the cylinders without the need for a hose or regulator.



	Super Carena R	1 Feu R
Reference	2000033792	27127ZCL
EAN code	3138520314837	3138520271277
Country cluster	IT-ES-PT-GR AT-BE-CH-DE-FR-IE-LU-NL-CZ-GR-MEA	FR-DE-AT-CH-IT-ES-PT-BE-NL-LU-DK-GR-MEA
Power	3000 W	1350 W
Gas consumption	220 g/h	99 g/h
Boil time	4 min	6 min
Ignition	Manual ignition	Manual ignition
Runtime	8 hrs on R904 12 hrs on R907	18hrs on R904 27hrs 45 min on R907
Fuel source	R904, R907	R904,R907
Weight	600 g	235 g
Dimensions (LxWxH)	Ø 19 x 11 cm	20 x 11 cm
Qt. Master carton	5	20

CAMPINGAZ®





Coolers

Cold, hot, large, small, rigid, soft, electric, traditional, funky, plain... we've got them all.

All our coolers are built to last and offer high performance at great value. Whether you're camping or just out in the countryside for the day, keeping your food and drink chilled is a basic luxury, and with a wide selection available, you'll find the right cooler for all occasions.

THE RIGHT COOLER...

Whether you are on a campsite, travelling by car or undertaking a spontaneous day trip - the Campinggaz® cooler ranges cover all your needs for different occasions, just choose the right one:



**ANTIMICROBIAL
LINER
PROTECTION
LIMITED TO PRODUCT**

An antimicrobial additive is melted down into the plastic before it's moulded into the liner to ensure that it's "there for life" and cannot be scratched off or weakened over time.



Thermoelectric coolers

Thanks to an integrated cooling system, Thermoelectric coolers offer a longer, excellent performance for your camping holiday and are treated with an antimicrobial liner. They can be plugged into:

- A car cigarette lighter
- A 230Vac via a transformer (integrated or sold separately)



Hard coolers

The Campinggaz® hard coolers are perfect for a weekend trip to keep your food and drinks fresh.

A wide range covers your individual needs and offers performance for your camping holiday:

- Antimicrobial treated lining only on Icetime Plus Extreme coolers
- Excellent insulation
- Superior quality supported by numerous tests



Soft coolers

A great combination of superior insulation, lightweight textiles and attractive designs for outings and short trips:

- Antimicrobial treated lining on all The Office and Jasmin soft cooler ranges
- Easy to carry thanks to its lightness
- Easy storage due to foldable system and flexible shoulder strap
- Easy to clean thanks to seamless inner liner and fabrics used
- Different designs ranging from 'Classic' to 'Fashion' meeting your individual desires



Freeze'Pack™ will increase your cooling performance



Flexi Freeze'Pack™ will increase your cooling performance



CAMPINGAZ

A guide to the new Campingaz® TE and passive cooler ranges

CAMPINGAZ® THERMOELECTRIC AND HARD-SIDED COOLERS

Campingaz® lineup of stylish & sleek, high performance electric and passive coolers, jam-packed with brand new features from the lid to the base! With the long-standing tradition and heritage for cooling performance from

Campingaz®, campers, picnic-goers, and vacationers alike can rest assured their food and drinks will stay cool for the whole journey!



FOUR MODE ADJUSTABLE COOLING PERFORMANCE

The Campingaz® Powerbox™ Plus AC/DC hard cooler features a control dial with 4 modes, allowing you to choose the performance and efficiency level. The coolers can be turned off by putting the dial on “OFF” mode without the need to unplug the cord.

To reduce the noise level of the fan switch to “NIGHT” mode. The internal fan operates at a 36db level, which is quieter than the suggested night noise level by WHO (World Health Organization)

For an efficient, yet environmental friendly operation, the “ECO” mode can be used, giving an A++ energy rating.

“MAX” mode is available for the ultimate cooling performance.



THICK, PREMIUM PU HARD COOLER INSULATION

Tests show that cooling loss is significant through the base of coolers.

Campingaz® models feature an increased insulation base and have two integrated, rounded feet providing the perfect amount of space for air to flow.

All Campingaz® hard coolers are constructed with Polyurethane (PU) insulation material, the highest quality insulation material available on the market — utilising more insulation on each of our new coolers than competitors!

Prior to assembling, the PU is injected into the casing of the cooler; whereas most competitors use Expanded Polystyrene – EPS which is 20% less effective than our PU insulated coolers.

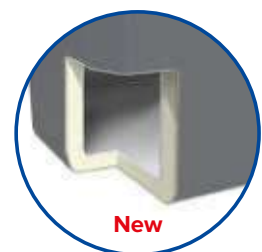
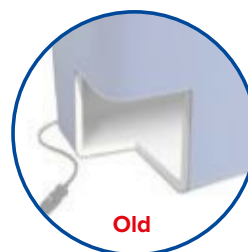

Increasingly more PU insulation compared to prior and competitor models.

SOFT COOLER INSULATION

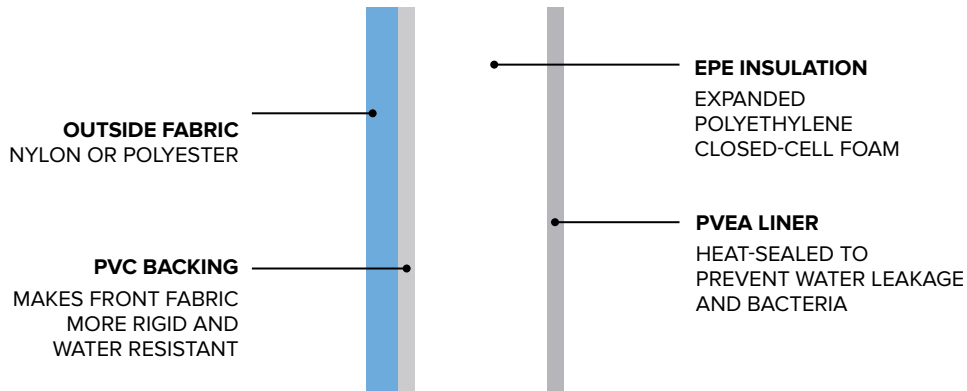

ANTIMICROBIAL LINER PROTECTION LIMITED TO PRODUCT

Campingaz® was the first TE cooler on the market to contain an antimicrobial liner which resists the formation of mould, mildew, and unpleasant odours which may develop from bacteria inside a cooler.

Our non-toxic, safe to use, antimicrobial effect is obtained from an additive which is melted down into the plastic before it's moulded into the liner and it's a lifetime treatment. It cannot be scratched off or weakened over time.

FREEZE GUARD

An integrated sensor protects cooler contents from being frozen.

Includes: Powerbox™ Plus 12V/230V

BATTERY SAVER

An electronic chip senses when a car battery does not have enough charge to start ignition and shuts off power to the TE cooler.



NEW HINGED LIDS AND WIDE LID OPENING

Snug fit handle for convenient storage, wide mouth for easy filling.

Includes: All new Campingaz® Passive and Electric coolers.





THERMOELECTRIC COOLERS

The Campinggaz® Powerbox™ Plus AC/DC active cooler range operates off a 12V car plug-in or a 230V electrical outlet (both cables included), combined with the high-performance injected PU foam, the coolers will keep contents at 19°C below the ambient temperature. They feature a control dial with 4 modes, allowing you to choose the performance and efficiency level. The

coolers can be turned off by putting the dial on “OFF” mode without the need to unplug the cord. To reduce the noise level of the fan switch to “NIGHT” mode, and for an efficient, yet environmental friendly operation, the “ECO” mode can be used, giving an A++ energy rating. “MAX” mode is available for the ultimate cooling performance. Assembled in Italy.



ANTIMICROBIAL LINER PROTECTION LIMITED TO PRODUCT

Inhibiting the ability of microorganisms to grow, many Campinggaz® coolers feature an Antimicrobial Liner, a powerful protection ensuring resistance to mould and mildew growth inside the coolers and it also blocks unpleasant odours from developing.

An antimicrobial additive is melted down into the plastic before it's moulded into the liner to ensure that it's “there for life” and cannot be scratched off or weakened over time.

The coolers can be turned off by putting the dial on “OFF” mode without the need to unplug the cord. To reduce the noise level of the fan switch to “NIGHT” mode, and for an efficient, yet environmental friendly operation, the “ECO” mode can be used, giving an A++ energy rating. “MAX” mode is available for the ultimate cooling performance



Powerbox™ Plus 36L 12/230V

Reference	2000037448
EAN code	3138522119751
Capacity	36L
Fit	10
Features	Thick, premium PU insulation, runs off a 12V car plug-in or a 230V wall outlet, built in transformer, four mode adjustable cooling performance, locking lid that 'clicks' on close, antimicrobial liner, two side handles, assembled in Italy
Insulation	PU
Insulation performance (+/- 1°C)	19 degrees below ambient temperature
Weight	5.2kg
Outer Dimension (LxHxW)	55.9 x 40.4 x 34.8 cm
Inner Dimension (LxHxW)	46.7 x 29 x 27.5 cm
Qt. Master carton	1



THERMOELECTRIC COOLERS

The Campingaz® thermoelectric cooler range is packed with 30% more premium insulation than its predecessor. When plugged into your car or into the main electricity port via a transformer, they keep their contents 20°C below the ambient temperature. The improved and very quiet fan emits a maximum of 39 dB, that won't wake you up at night! The power cord and plug can also be easily removed and conveniently stored inside the cooler during non-use. The 12V easily removable cord can be quickly stored inside the cooler when not in use.

The Campingaz® thermoelectric coolers also have a breakthrough, antimicrobial liner that resists odour, mould and mildew. The antimicrobial additive is injected into the plastic of the liner, meaning it's there for the life of the cooler – it can never be scratched off or removed. With a new and modern shape built from strong and thick polypropylene these coolers stay cool for hours even when unplugged.



ANTIMICROBIAL LINER PROTECTION LIMITED TO PRODUCT

Inhibiting the ability of microorganisms to grow, many Campingaz® coolers feature an Antimicrobial Liner, a powerful protection ensuring resistance to mould and mildew growth inside the coolers and it also blocks unpleasant odours from developing.

An antimicrobial additive is melted down into the plastic before it's moulded into the liner to ensure that it's "there for life" and cannot be scratched off or weakened over time.



	Powerbox™ Plus 36L	Powerbox™ Plus 28L	Powerbox™ Plus 24L
Reference	2000037448	2000024956	2000024955
EAN code	3138522119751	3138522087104	3138522087098
Capacity	36L	28L	24L
Fit	10	6	5
Features	Thick, premium PU insulation, runs off a 12V car plug-in, locking lid that 'clicks' on close, antimicrobial liner, two side handles, assembled in Italy	Thick, premium PU insulation, runs off a 12V car plug-in, locking lid that "clicks" on close, antimicrobial liner resists odour, mould & mildew, bail handle for easy transportation on 24/28, modern Campingaz® look and design, assembled in Italy	Thick, premium PU insulation, runs off a 12V car plug-in, locking lid that "clicks" on close, antimicrobial liner resists odour, mould & mildew, bail handle for easy transportation on 24/28, modern Campingaz® look and design, assembled in Italy
Insulation	PU	PU	PU
Insulation performance (+/- 1°C)	19 degrees below ambient temperature	20° delta versus outside ambient temperature	20° delta versus outside ambient temperature
Weight	5.2kg	3.7kg	3.6kg
Outer Dimension (LxHxW)	55.9 x 40.4 x 34.8 cm	40.8 x 46.9 x 32.3 cm	40.8 x 42.3 x 32.3 cm
Inner Dimension (LxHxW)	46.7 x 29 x 27.5 cm	32.8 x 34.8 x 24.3 cm	32.8 x 31 x 24.3 cm
Qt. Master carton	1	1	1

ICETIME™ PLUS COOLERS

Sporting a modern style from Campingaz®, the Icetime™ Plus coolers are perfect for a day-long picnic or a trip to the beach. With a tough outer shell and packed with premium PU insulation, this cooler will keep your

contents fresh all day long! The convenient bail handle design makes transportation a breeze no matter how much content you put in your cooler. Recommended for use with Campingaz® Freez'Packs™. Made in Italy.



	Icetime™ Plus 38L	Icetime™ Plus 30L	Icetime™ Plus 26L
Reference	2000024960	2000024963	2000024962
EAN code	3138522087142	3138522087173	03138522087166
Capacity	38L	30L	26L
Fit	9	6	6
Features	Thick, premium PU insulation, bail handle for easy transportation on 24/28, locking side handles for 36L, modern, refreshed Campingaz® look and design, made in Italy	Thick, premium PU insulation, bail handle for easy transportation on 24/28, locking side handles for 36L, modern, refreshed Campingaz® look and design, made in Italy	Thick, premium PU insulation, bail handle for easy transportation on 24/28, locking side handles for 36L, modern, refreshed Campingaz® look and design, made in Italy
Insulation	PU	PU	PU
Insulation performance (+/- 1°C)	30 hours	27 hours	24 hours
Weight	3.6kg	2.6kg	2.4kg
Outer Dimension (LxHxW)	55.9 x 40.4 x 34.8 cm	40.8 x 46.9 x 32.3 cm	40.8 x 42.3 x 32.3 cm
Inner Dimension (LxHxW)	46.7 x 30.1 x 27.5 cm	32.8 x 36.6 x 24.3 cm	32.8 x 32.9 x 24.3 cm
Qt. Master carton	1	1	1

ISOTHERM EXTREME COOLERS

The Isotherm Extreme coolers keep contents cool all day thanks to high quality insulation and an integrated airtight seal. A tough outer shell offers increased durability and

it includes a built in storage tray and rack for efficient packing. An incorporated drain makes it easy to clear out and a sturdy handle doubles up as a safety locking device.



	Icetime™ 13L
Reference	39401ZCL
EAN code	3138520394013
Capacity	13 L
Fit	7 x 0.5 L vertically
Features	
Insulation	
Insulation performance (+/- 1°C)	17 hrs with Freez'Pack™ units (1x M10 + 1x M20) (sold separately)
Weight	1.9 kg
Dimension (LxHxW)	29 x 18 x 39 cm
Qt. Master carton	1



ETHNIC RANGE

Stay stylish and cool for summer with our Ethnic Range of soft coolers. Your food will be cool and you'll look fashionable at a picnic, on the beach, or even strolling through the city. Find the model that suits your needs – range varies in terms of size and appeal.



	Shopping Cooler 15L	Day Bacpac 9L	Bottle Cooler 1.5L
Reference	2000033080	2000032469	2000032468
EAN code	3138522092856	3138522103958	3138522103941
Capacity	15.7L	9.2L	1.5L
Insulation	3/2mm EPE closed-cell foam insulation	6mm EPE closed-cell foam insulation	6mm EPE closed-cell foam insulation
Fit	5 x 1.5L	2 x 1.5L	1 x 1.5L
Features	2 handles	Foldable cooler, Central cooling pocket with large opening, One front and 2 side pockets	Foldable cooler
Insulation performance (+/- °C)	10 hrs with Freez'Pack™ units (sold separately)	10 hrs 30 min with Freez'Pack™ units (sold separately)	4 hrs with Freez'Pack™ units (sold separately)
Weight	390g	480g	210g
Dimensions (LxHxW)	35.5 x 32 x 18 cm	30 x 48 x 45 cm	34.3 x 12 cm
Qt. Master carton	12	6	12



	MiniMaxi 29L	MiniMaxi 19L	MiniMaxi 9L	MiniMaxi 4L
Reference	2000032467	2000032466	2000033082	2000033081
EAN code	3138522103934	3138522103927	3138522092849	3138522092832
Capacity	29L	19L	9L	4L
Insulation	6mm EPE closed-cell foam insulation	6mm EPE closed-cell foam insulation	6mm EPE closed-cell foam insulation	6mm EPE closed-cell foam insulation
Fit	8 x 1.5L	6 x 1.5L	12 x 0.33L cans or 8 x 0.5L bottles	6 x 0.33L cans or 4 x 0.5L bottles
Features	Foldable cooler, adjustable shoulder strap, side pocket	Foldable cooler, side pocket	Foldable cooler, side pocket	Foldable cooler, side pocket
Insulation performance (+/- °C)	13 hrs 40 min with Freez'Pack™ units (sold separately)	12 hrs with Freez'Pack™ units (sold separately)	9 hrs with Freez'Pack™ units (sold separately)	7 hrs with Freez'Pack™ units (sold separately)
Weight	840g	550g	350g	270g
Dimensions (LxHxW)	37 x 36 x 19.5 cm	27.5 x 37 x 19.5 cm	30.5 x 20.5 x 16 cm	22 x 15.5 x 14 cm
Qt. Master carton	8	6	8	12



CAMPINGAZ

CLASSIC SOFT COOLERS

Our classic soft coolers are comfortable to carry and come in a variety of shapes and sizes. When you're finished, many of them fold up to be stored away easily.



	Fold'N Cool 30L	Fold'N Cool 20L	Fold'N Cool 10L
Reference	2000011725	2000011724	2000011723
EAN code	3138522063177	3138522063160	3138522063153
Capacity	30L	20L	10L
Insulation	6mm EPE closed-cell foam insulation	6mm EPE closed-cell foam insulation	6mm EPE closed-cell foam insulation
Fit	Holds 9 x 1.5L bottles vertically and 12 x 1.5L horizontally	Holds 6 x 1.5L bottles vertically and 5 x 1.5L horizontally	Holds 8 x 0.5L bottles vertically and 10 x 0.5L horizontally
Features	16 hrs with Freez'Pack™ units (sold separately)	14 hrs with Freez'Pack™ units (sold separately)	13 hrs with Freez'Pack™ units (sold separately)
Insulation performance (+/- °C)	Foldable cooler, adjustable shoulder strap	Foldable cooler, adjustable shoulder strap	Foldable cooler, adjustable shoulder strap
Weight	488g	376g	270g
Dimensions (LxHxW)	24.9 x 39.2 x 38.2 cm	19.6 x 32.2 x 37 cm	17.9 x 31.3 x 24.5 cm
Qt. Master carton	8 -1 x merch of 8	12 -2 x merch of 6	16 -2 x merch of 8



	Fold'N Cool 5L	Bottle 1.5L
Reference	2000011722	2000011727
EAN code	3138522063146	3138522063191
Capacity	5L	1.5L
Insulation	6mm EPE closed-cell foam insulation	6mm EPE closed-cell foam insulation
Fit	Holds 6 x 0.33L bottles vertically or horizontally	1 x 1.5L
Features	8 hrs with Freez'Pack™ units (sold separately)	Foldable cooler, adjustable shoulder strap
Insulation performance (+/- °C)	Foldable cooler, adjustable shoulder strap	5 hrs with Freez'Pack™ units (sold separately)
Weight	196g	210g
Dimensions (LxHxW)	15.5 x 23.4 x 19.2 cm	11.4 x 34.4 x 21 cm
Qt. Master carton	12 -1 x merch of 12	12 -1 x merch of 12



ACCESSORIES

Our Freez'Pack™ units can be used in every cool box or soft cooler to keep food and drinks cooler for longer. They're available in a range of sizes and shapes, and the bigger they are, the longer they stay cool.

	Freez'Pack™			
	M5 x 2	M 10	M 20	M 30
Reference	39040	9377ZCL	9378	21628ZCL
EAN code	3138520390404	3138520093770	3138520093787	3138520216285
Features	For keeping drinks, food or medicines cool for longer in your passive hard or soft cooler. Food-safe materials, dishwasher proof, reusable, components: water, carboxymethylcellulose, acticide and blue colorantv			



	Flexi Freez'Pack™ M
Reference	2000010674
EAN code	3138522061098
Size	L19.5 x H24 x W1.8cm
Weight	300g
Features	Maximise the use of internal space in your cooler. This Freez'Pack™ stays flexible even when frozen, and wraps like a blanket around the contents of your freezer. Designed for coolers between 11L and 18L (M)



	Frozen Food Bag	
	Small	Large
Reference	205281	205282
EAN code	3138522052812	3138522052829
Features	The excellent insulated bag keeps food cold and prevents thawing of frozen food. <ul style="list-style-type: none"> • Material: PE low density • 2 strong resistant plastic handles • Available in Small or Large 	



	Basic Cooler 15L
	Red
Reference	203160
EAN code	3138522031602
Capacity	15 L
Weight	364 g
Features	Two attractive colour options. <ul style="list-style-type: none"> • Holds 5x 1.5L bottles vertically • Large central opening • 2 long side handles • Cooling performance: 10h with Freez'Pack™ units (sold separately)





CAMPINGAZ®



Lanterns

Our Campingaz® lanterns brighten your outdoor adventures and camping trips.

Explore our great range of cylinder and cartridge lanterns and find what suits your individual needs best.

VALVE CARTRIDGE LANTERNS

We offer a complete range of valve cartridge appliances covering most consumer uses. They're equipped with a high security self-sealing valve, so they can be easily and safely disconnected and reconnected whether they're empty or not.



Camping 206 L

Reference	2000035218
EAN code	03138522113261
Country cluster	GB-FR-IE-DE-AT-CH-NL-IT-BE-LU-GR-CY-CZ-UA-ARA
Power	80 W
Gas consumption	38 g/h
Ignition	Manual ignition
Runtime	5 hrs
Fuel source	C206GLS
Weight	470g
Dimensions (LxWxH)	Ø 12 x 26 cm
Qt. Master carton	10

LANTERN ACCESSORIES

Campingaz® lantern accessories include globes and mantles that help to extend the life of Campingaz® products and are compatible with all of our lanterns.

Gas mantle Size S

Ref: 68221

EAN: 3138520682219

Pack of 3 mantles
for Campingaz® lanterns



BRAND	SKU	NAME	MANTLE S	MANTLE M
CURRENT MODELS				
Campingaz®	204193/204194	LUMOGAZ™ PLUS LANTERN	✓	
Campingaz®	204195/2000035224	LUMOSTAR™ PLUS PZ LANTERN	✓	
Campingaz®	2000035218	LANTERN CAMPING 206	✓	
PAST MODELS				
Campingaz®	204191/2000010182	LUMOSTAR™ PLUS LANTERN	✓	
Campingaz®	204683	CAMPING 206 LANTERN	✓	
Campingaz®	204687	SUPER LUMO 206 PZ	✓	
Campingaz®	204696	BLEUET™ CV300 LANTERN	✓	
Campingaz®	204697	BLEUET™ CV300 PZ LANTERN	✓	
Campingaz®	na	BIVOUAC™	✓	
Campingaz®	na	L 470		✓
Campingaz®	na	LUMOGAZ 270, N 206, T 206, R, RPZ, 470	✓	
Campingaz®	na	LUMOSTAR C, M	✓	
Campingaz®	na	MINIGAZ™ 106	✓	
Campingaz®	na	MONT BLANC™	✓	
Campingaz®	na	RHAPSODY™ 470		✓
Campingaz®	na	SOLEIO™	✓	
Campingaz®	na	SOLEIO™ R		✓
Campingaz®	na	SUN FORCE™		✓
Campingaz®	na	SUPER LUMOGAZ™ 206	✓	
Campingaz®	na	SYMPHONY™, SUPER SYMPHONY™		✓

CAMPINGAZ®





CAMPINGAZ.
PT 2000

DIY

Whether you want to work in and around the house, tidy up weeds and light bonfires, we'll help you enjoy your time in your house and the garden. Campingaz® products for DIY are designed to make life easier.

You can use blowtorches on a whole range of jobs, from stripping paint to clearing weeds or even just starting a bonfire.

PIERCEABLE CARTRIDGE BLOWTORCHES

The Pierceable blowtorches, in particular the Soudogaz® X2000 and the Soudogaz® X2000 PZ, are our bestsellers among blowtorches, they are our icon products and well-known for years. They are extremely versatile tools, ideal for many types of DIY jobs. The Soudogaz® X2000 models are equipped with a metal housing, for a greater

protection of the cartridge and for longer durability. The cartridge can be easily loaded and connected. The nozzle is in brass and it can be easily removed; it is compatible with separately sold multifunction accessories. The blowtorches have a comfortable grip and the power can be adjusted precisely.



	Soudogaz® X2000 PZ	Soudogaz® X2000	PT2000
SKU	2000026177	202921	2000026173
EAN Code	3138522089047	3138522029210	3138522089009
Country Cluster	Fr De At Ch It Gr Ru Ro Bg Tr	Fr De At Ch It Gr Ru Ro Bg Tr	FR GB DE NL IT ES PT DK SE NO FI CZ PL HU GR RU TR
Cartridge type	C206	C206	C206
Cartridge included	No	No	No
Ignition	Piezo	Manual	Manual
Flame Temperature in C°	1800	1800	1750
Power in Watt	1650	1650	1650
Gas Consumption	120 g/h	120 g/h	120 g/h
Dimensions	25 x 11 x 19 cm	25 x 11 x 19 cm	26 x 12 x 15 cm
Weight	500g	480g	400g
Nozzle	X1700	X1550	X1400
Compatible Nozzle Accessories	XP1650, X1650	XP1650, X1650	XP1650, X1650
Qt. master carton (units)	10	10	10

LABOGAZ

Heating of solutions in beakers, flasks and test tubes. Varnish/Paint drying, cooking glue. Bending of small pipes.
Field of applications: Laboratories, schools, Jewellery/Optics, handycraft work.



	Labogaz 206
SKU	2000020656
EAN Code	03138522081195
Country Cluster	GB, FR, DE, NL, IT, ES, PT, DK, NO, SE, FI, CZ, PL, SK
Cartridge type	Pierceable cartridge C 206 GLS
Cartridge included	No
Ignition	Manual
Flame Temperature in C°	max. 1500 °C
Power in Watt	0,76 kW
Gas Consumption	55g/h
Dimensions	11.8 x 9.4 x 16 cm (l x w x h)
Weight	380g
Qt. master carton (units)	12

CAMPINGAZ®





Help section

- Pictograms recap
- Glossary

CARTRIDGES FEATURES

Valve cartridges: Featuring a self-sealing valve, they can be disconnected and reconnected even when not empty!



CV300 Plus



CP250



CV470 Plus

Pierceable cartridges: Single use cartridge with the exclusive Clip & Go™ system makes cartridge connection and replacement very easy and user friendly.



C206



C206 GLS



Easy Clic™ Plus: Simple method for attaching a valve cartridge



1. Click.
Simply press the appliance into the valve cartridge.



2. Rotate.
Twist the appliance 45° to the left to secure cartridge.

COOLER FEATURES



A non-toxic and safe antimicrobial treatment on the liners to stop mildew, mould, and odour-forming bacteria.



12Vdc: Runs off 12Vdc car cigarette lighter.



12Vdc/230Vac: Can be used in 230Vac mode with an 230Vac/12Vdc transformer.



Capacity: Capacity of the cooler, indicated by the amount of litres that the cooler can hold.



Capacity: Capacity of the cooler, indicated by numbers of bottles that the cooler can hold.



Cooling performance: Guarantees 17 hours (numbers will vary) temperatures below 15°C (with Freez'Pack).



Cooling function: The outside temperature minus 18 degrees Celsius (number varies between products) equals the temperature inside the cooler.



WARRANTY APPLICATION TERMS AND CONDITIONS: Please refer to the Instruction Manual. To find out more about our warranty visit www.campinggaz.com and view the After Sales section.

TYPE OF IGNITION



Piezo ignition: In a traditional piezo ignition, a small hammer hits against a crystal which creates a small spark that is used to ignite the gas. This always happens with an easily recognizable sound. Sometimes it needs more than one push to successfully ignite the gas with a piezo ignition.



Electronic ignition: Easy start due to a battery-powered circuit. A battery-powered tension is used to create a spark. The typical noise here is a silent clicking.



InstaStart™ ignition: This special type of electronic ignition is a convenient push and turn-button lighting system designed specifically for our BBQ grills. Pushing the button creates a spark. Turning the same button starts the flow of gas, that then ignites the spark to become a flame.



Push & Turn Piezo ignition: This special type of ignition is a convenient push and turn-button lighting the system designed specifically for our gas stoves. Pushing the button creates a spark. Turning the same button starts the flow of gas, that then ignites the spark to become a flame.

BBQ FEATURES



Stainless steel burners



Standard burners



Patented blue flame burner



Side burner: More cooking possibilities with a side burner that can be used for pots and pans.



Even Temp™ Technology: Even heat distribution across the entire cooking surface.



Less flare ups: Designed for healthier cooking with less flaring from the burners.

BBQ FEATURES



Campingaz InstaClean™ System:
Removable dishwasher safe parts.



Easy clean: Can be washed and cleaned easily.



Campingaz™ Culinary Modulars:
Experience different cooking possibilities with exchangeable inserts.



Thermometer



Durable cast iron grilling grid with integrated resistance protection reducing the risk of flare-ups



Foldable side tables: Fold away for space saving storage.



Slidable side tables: Slide away for space saving storage.



Number of people that can be served per grilling session



Illuminated control knobs

STOVE FEATURES



Power adjustable: Fully adjustable power.



Boiling time: Takes 3min and 3sec until boiling (numbers will vary)



Quick cooking: Quick cooking using a powerful burner.



Stopgaz: for added safety, the gas cuts off automatically if the flame is blown out.



Weight: Product weight.



Regulator and hose included



Easy to carry: Convenient carrying and easy storage.



Fat collecting: Fat collecting system for healthier cooking.



Stable and tough base for better stability when cooking and working on uneven surfaces

GR UA CY RS MEA IN TR

**Application Des Gaz
Export**

BP 55 – route de Brignais
69563 SAINT GENIS LAVAL
FRANCE
Tel : +33 (0) 4 78 86 87 00
iexport@newellco.com

ISO 9001**Quality Management System Approved by LRQA**

Over the years, Campingaz® has demonstrated its commitment to customer satisfaction by focusing on the quality and safety of its products. Application des Gaz (Saint Genis Laval, France) and Camping Gaz Italia (Centenaro di Lonato, Italia) have both been awarded Iso 9001 certificates in recognition of their quality assurance programmes which are applied to every stage of product design, manufacturing, quality control, development and delivery.

The Quality Management System is applicable to design, inter-company purchasing or sourcing, industrialization, manufacturing, storage and distribution of gas appliances and other outdoor leisure and camping products, barbecue and accessories. LPG cartridges, gas cylinders, DIY appliances and accessories under the Campingaz® brand name.



Due to our policy of continuous improvement, Application des Gaz reserves the right to alter or change the specifications of models shown. Some articles may vary in availability and specification from country to country. Please check with your local Campingaz® organization for further details. All pictures are non-contractual. All trademarks contained herein are the property of their respective owners.