

BLC

Ventilatori centrifughi / Centrifugal electric blowers

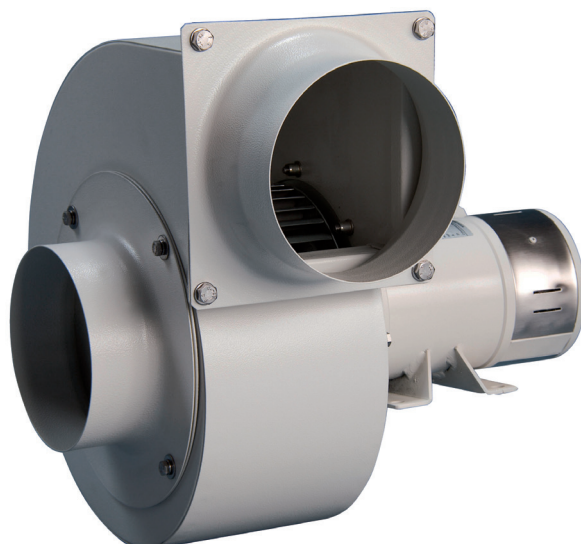

BLC

DESCRIZIONE E APPLICAZIONI

Ventilatori centrifughi largamente utilizzati sulle imbarcazioni per l'aspirazione e la ventilazione di aria nei locali chiusi (WC, cucine, sala macchine, ecc.).

CARATTERISTICHE COSTRUTTIVE

- Carcassa: a spirale in acciaio verniciato.
 - Ventola: in acciaio a pale inclinate in avanti, dinamicamente e staticamente bilanciata.
- Nota: i ns. ventilatori sono forniti di serie con le flange portatubo in aspirazione e in mandata e la rete di protezione in aspirazione.

MOTORE ELETTRICO

- **Corrente Continua:**
Motore elettrico a magneti permanenti 12/24V, protezione IP 23+44, Classe di Isolamento F, Servizio continuo (S1).
- **Corrente Alternata:**
Motore elettrico asincrono 230V monofase (M) / 230+400V trifase (T), 50Hz, protezione IP44+55, Classe di Isolamento F, Servizio continuo (S1).

ORIENTAMENTO

Attenzione: deve essere necessariamente indicato in fase di ordine

- **RD:** direzione destra
- **LD:** direzione sinistra

DESCRIPTION AND USE

Centrifugal electric blowers widely used on board for extraction and ventilation of air in closed environments (WC, kitchens, engine rooms, etc.).

CONSTRUCTION FEATURES

- *Spiral casing: made of painted steel.*
 - *Fan: steel forward blade, dynamically and statically balanced.*
- Note: our blowers are supplied of series with flanged fittings in the inlet and outlet side and a safety grid in the inlet side.*

ELECTRIC MOTOR

- **Direct Current:**
Permanent magnets motor 12/24V, Protection IP 23+44, Insulation Class F, Continuous Duty (S1).
- **Alternating Current:**
Induction electric motor, 230V single-phase (M) / 230+400V three-phase (T), 50Hz, Protection IP44+55, Insulation Class F, Continuous Duty (S1).

ORIENTATION

Attention: the orientation of the blower must be stated when the ordering

- **RD:** right direction
- **LD:** left direction

Standard

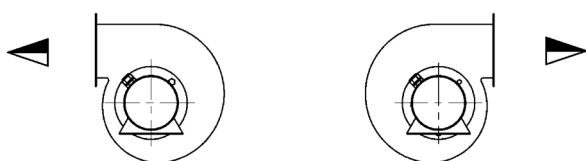

LD 90°
Direzione SINISTRA
LEFT direction

RD 90°
Direzione DESTRA
RIGHT direction

Esecuzioni a richiesta Executions on request

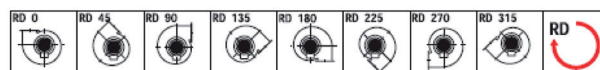

Rotazione oraria - Clockwise rotation sense

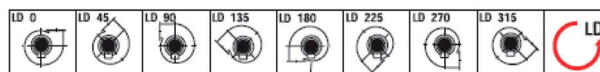

Rotazione anti-oraria - Anti-Clockwise rotation sense

Vista lato motore View from motor side

PRESTAZIONI / PERFORMANCES

Modello Type	Voltaggio Voltage (V)	Potenza Power		Assorbimento Absorption (A)	Giri/min. RPM	dBA	Portata Max. Max. delivery (m ³ /min.)	Pressione Max. Max. pressure (mmH ₂ O)
		HP	kW					
BLC 002	12	0,12	0,09	3,2	2800	47	4,5	22
	24	0,12	0,09	1,6	2800	47	4,5	22
	230M	0,12	0,09	0,8	2800	47	4,5	22
	230+400T	0,12	0,09	0,5+0,3	2800	47	4,5	22
BLC 003	12	0,25	0,18	8	2800	55	10	45
	24	0,25	0,18	4	2800	55	10	45
	230M	0,25	0,18	1	2800	60	10	45
	230+400T	0,25	0,18	0,9+0,6	2800	60	10	45
BLC 004	12	0,15	0,12	6	2500	56	12	47
	24	0,15	0,12	3	2500	56	12	47
	230M	0,35	0,25	2,2	2800	65	15	60
	230+400T	0,35	0,25	1,3+0,8	2800	65	15	60
BLC 015	12	0,35	0,25	24	1400	55	24	34
	24	0,35	0,25	12	1400	55	24	34
	230M	0,35	0,25	2,2	1400	55	24	34
	230+400T	0,35	0,25	1,3+1,8	1400	55	24	34
BLC 028	12	0,4	0,3	26	2800	65	24	84
	24	0,4	0,3	14	2800	65	24	84
	230M	0,5	0,37	2,8	2800	65	24	84
	230+400T	0,5	0,37	1,5+0,9	2800	65	24	84
BLC 023	12	0,75	0,55	30	2000	70	37	64
	24	0,75	0,55	22	2000	70	37	64
	230M	1,5	1,1	7	2800	76	58	130
	230+400T	1,5	1,1	5+2,9	2800	76	58	130
BLC 025	24	0,75	0,55	30	1400	70	50	55
	230M	0,75	0,55	5,2	1400	70	50	55
	230+400T	0,75	0,55	3,6+2,2	1400	70	50	55
BLC 030	230M	1,5	1,1	7,2	1400	74	66	80
	230+400T	1,5	1,1	5+2,9	1400	74	66	80
BLC 035	230M	3	2,2	13,5	1400	79	90	100
	230+400T	3	2,2	9,2+5,4	1400	79	90	100
BLC 036	230+400T	4	3	11,6+7	1400	79	133	100
BLC 040	230+400T	7,5	5,5	21+11,5	1400	82	190	140
BLC 045	400+690T	15	11	22,3+12,9	1400	86	265	180

12V-24V: CORRENTE CONTINUA / DIRECT CURRENT

230M, 50Hz: corrente alternata monofase / single-phase alternating current

230+400T/400+690T, 50Hz: corrente alternata trifase / three-phase alternating current

A richiesta disponibili altri voltaggi a 50Hz e 60Hz / Available on request other voltages at 50Hz and 60Hz.

CORRENTE CONTINUA (c.c.) / DIRECT CURRENT (d.c.)

PRESTAZIONI / PERFORMANCES

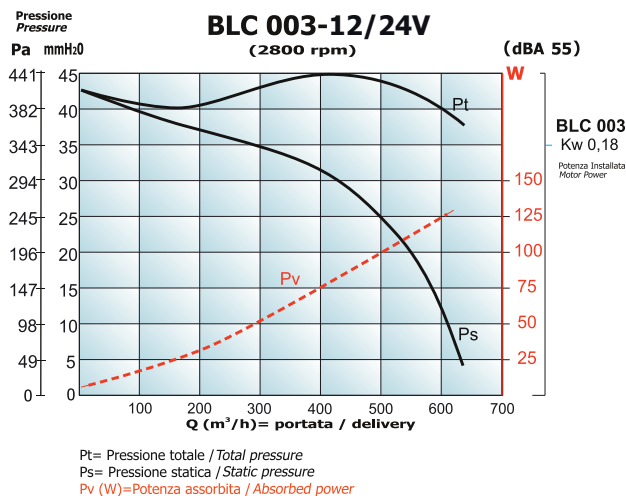
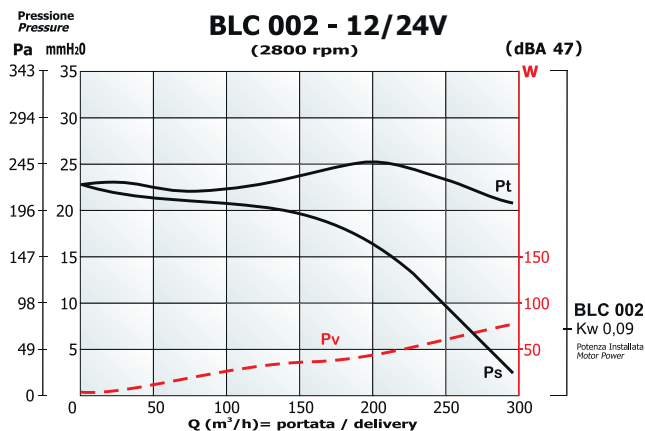

Modello Type	Voltage (V)	Potenza / Power		Assorbimento Absorption (A)	Giri/min. RPM	dBA	Pressione totale Total pressure	Pa	225	226	235	245	225	206
		HP	kW					mmH ₂ O	23	22,5	24	25	23	21
BLC 002	12	0,12	0,09	3,2	2800	47	Portata Delivery (m3/h)	50	100	150	200	250	300	
	24	0,12	0,09	1,6	2800	47		50	100	150	200	250	300	

Modello Type	Voltage (V)	Potenza / Power		Assorbimento Absorption (A)	Giri/min. RPM	dBA	Pressione totale Total pressure	Pa	397	397	421	441	431	392
		HP	kW					mmH ₂ O	40,5	40,5	43	45	44	40
BLC 003	12	0,25	0,18	8	2800	55	Portata Delivery (m3/h)	100	200	300	400	500	600	
	24	0,25	0,18	4	2800	55		100	200	300	400	500	600	

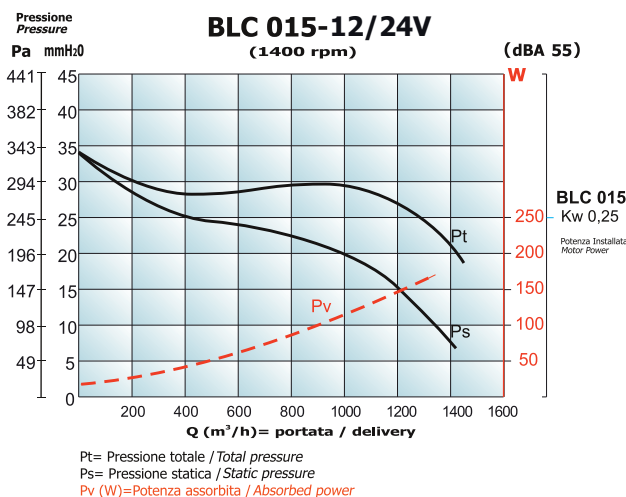
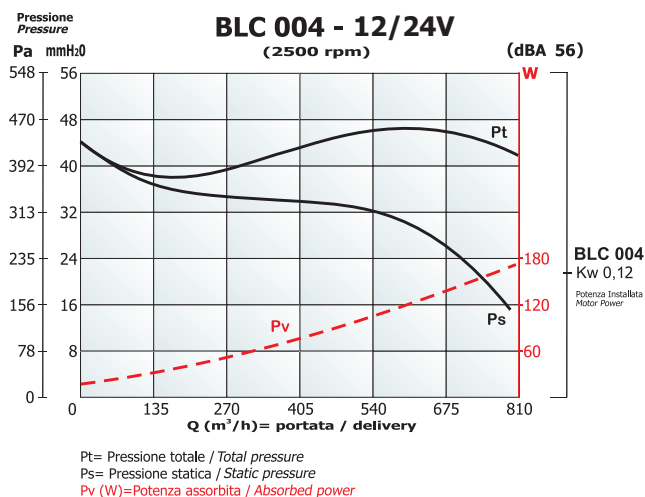

Modello Type	Voltage (V)	Potenza / Power		Assorbimento Absorption (A)	Giri/min. RPM	dBA	Pressione totale Total pressure	Pa	382,2	392	441	461	461	402
		HP	kW					mmH ₂ O	39	40	45	47	47	41
BLC 004	12	0,15	0,12	6	2500	56	Portata Delivery (m3/h)	135	270	405	540	675	810	
	24	0,15	0,12	3	2500	56		135	270	405	540	675	810	

Modello Type	Voltage (V)	Potenza / Power		Assorbimento Absorption (A)	Giri/min. RPM	dBA	Pressione totale Total pressure	Pa	294	284	284	294	294	265	196
		HP	kW					mmH ₂ O	30	29	29	30	30	27	20
BLC 015	12	0,35	0,25	24	1400	55	Portata Delivery (m3/h)	200	400	600	800	1000	1200	1400	
	24	0,35	0,25	12	1400	55		200	400	600	800	1000	1200	1400	

CORRENTE CONTINUA (c.c.) / DIRECT CURRENT (d.c.)

PRESTAZIONI / PERFORMANCES

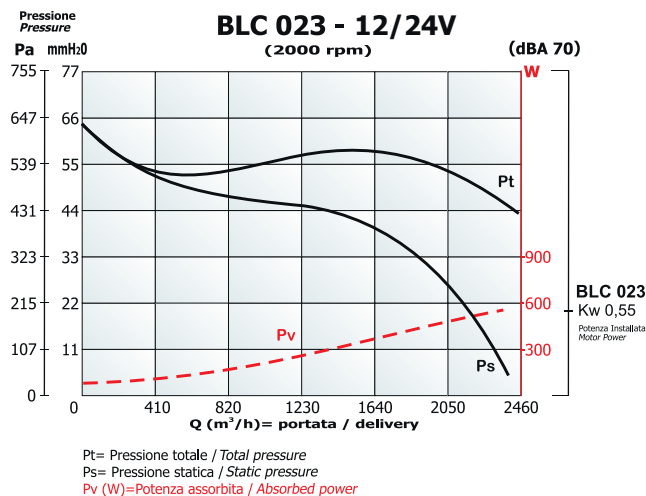
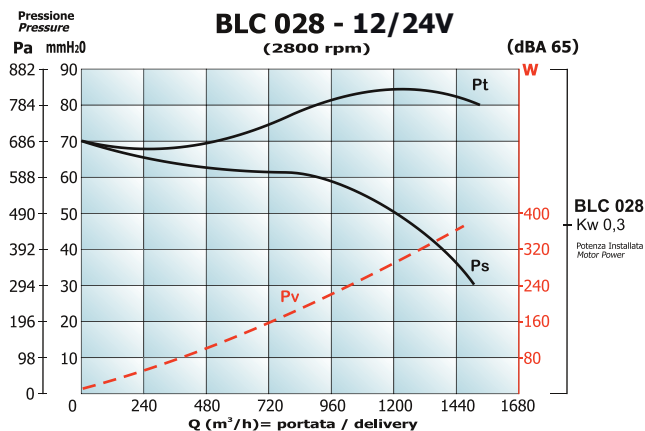

Modello Type	Voltaggio Voltage (V)	Potenza / Power		Assorbimento Absorption (A)	Giri/min. RPM	dBA	Pressione totale Total pressure	Pa	676,2	686	735	784	833	784
		HP	kW					mmH ₂ O	69	70	75	80	85	80
BLC 028	12	0,4	0,3	26	2800	65	Portata Delivery (m ³ /h)	240	480	720	960	1200	1440	
	24	0,4	0,3	14	2800	65		240	480	720	960	1200	1440	

Modello Type	Voltaggio Voltage (V)	Potenza / Power		Assorbimento Absorption (A)	Giri/min. RPM	dBA	Pressione totale Total pressure	Pa	519	529	549	559	519	431
		HP	kW					mmH ₂ O	53	54	56	57	53	44
BLC 023	12	0,75	0,55	30	2000	70	Portata Delivery (m ³ /h)	410	820	1230	1640	2050	2460	
	24	0,75	0,55	22	2000	70		410	820	1230	1640	2050	2460	

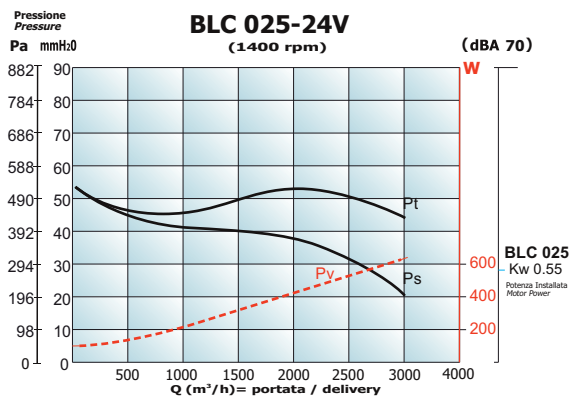

Modello Type	Voltaggio Voltage (V)	Potenza / Power		Assorbimento Absorption (A)	Giri/min. RPM	dBA	Pressione totale Total pressure	Pa	441	441	490	539	490	441
		HP	kW					mmH ₂ O	45	45	50	55	50	45
BLC 025	24	0,75	0,55	30	1400	70	Portata Delivery (m ³ /h)	500	1000	1500	2000	2500	3000	

CORRENTE CONTINUA (c.c.) / DIRECT CURRENT (d.c.)

DIMENSIONI E PESI / DIMENSIONS AND WEIGHTS

BLC

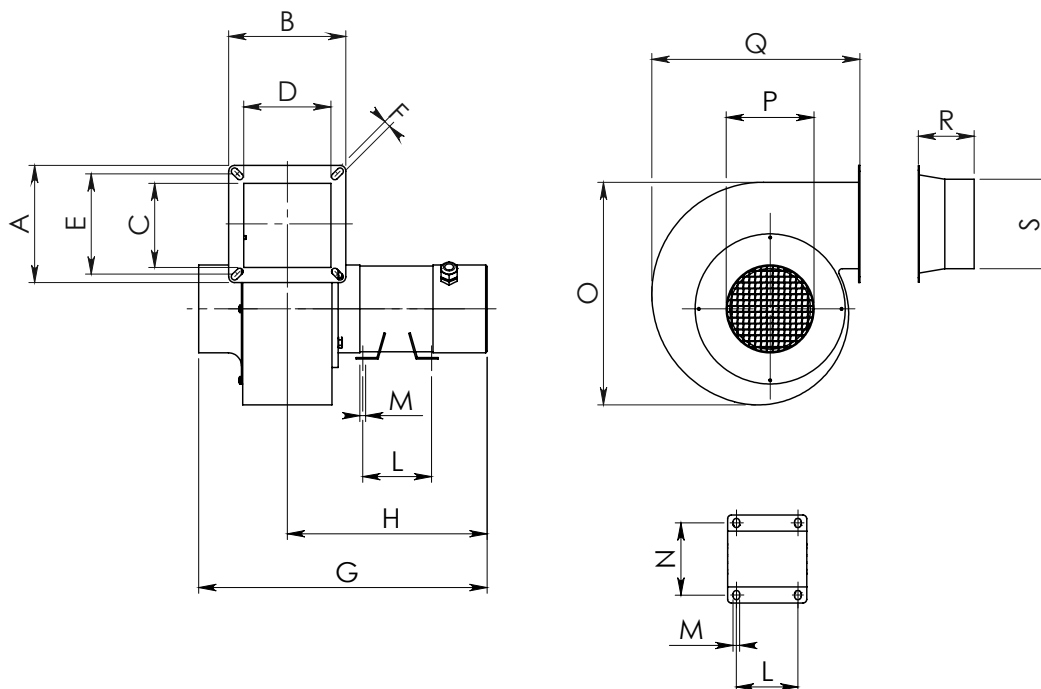

SUPPORTO MOTORE
(MOTOR SUPPORT)

Modello Type	Corrente Current	A	B	C	D	E	F	G	H	L	M	N	O	P	Q	R	S	Peso Weight (kg)
BLC 002	c.c - d.c.	105	110	60	70	90	7	295	210	80	7	100	190	58	168	50	58	3,5
BLC 003	c.c - d.c.	140	140	85	85	110	7	370	255	80	7	100	270	98	225	60	98	5,5
BLC 004	c.c - d.c.	130	155	85	110	110	9	370	255	80	7	100	270	98	225	75	98	6
BLC 028	c.c - d.c.	160	160	110	110	135	9	390	270	90	8	112	322	118	273	75	98+118	10
BLC 015	c.c - d.c.	190	190	140	140	135	9	415	275	90	8	112	405	148	338	75	148	14
BLC 023	c.c - d.c.	215	215	160	160	192	N° 8 x Ø 11	530	340	90	8	112	420	200	340	150	160	18
BLC 025	c.c - d.c.	255	255	200	200	232	N° 8 x Ø 11	570	370	90	8	112	510	250	420	150	200	23

Misure in millimetri (mm), dimensioni non impegnative / Measures in millimeter (mm), dimensions approximated

CORRENTE ALTERNATA (c.a.) / ALTERNATING CURRENT (a.c.)

PRESTAZIONI / PERFORMANCES

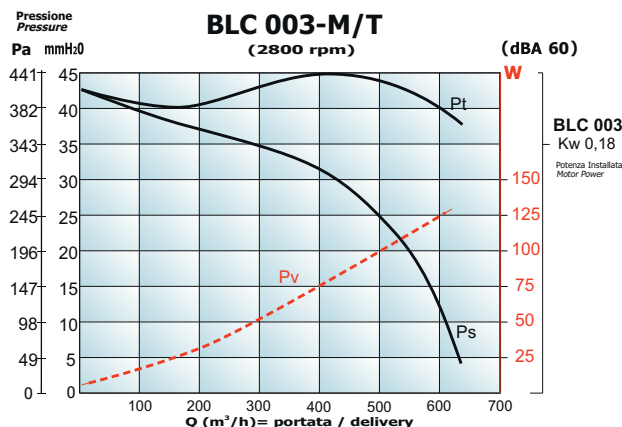
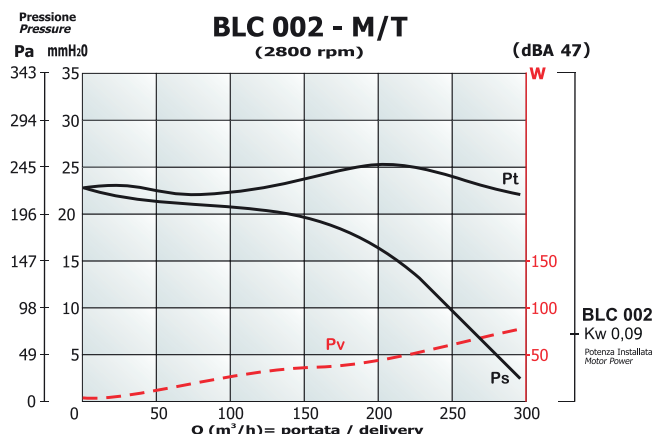

Modello Type	Voltage (V)	Potenza / Power		Assorbimento Absorption (A)	Giri/min. RPM	dBA	Pressione totale Total pressure	Pa	225	226	235	245	235	217
		HP	kW					mmH ₂ O	23	22,5	24	25	24	22
BLC 002	230M	0,12	0,09	0,8	2800	47	Portata Delivery (m3/h)	50	100	150	200	250	300	
	230+400T	0,12	0,09	0,5+0,3	2800	47		50	100	150	200	250	300	

Modello Type	Voltage (V)	Potenza / Power		Assorbimento Absorption (A)	Giri/min. RPM	dBA	Pressione totale Total pressure	Pa	397	397	421	441	431	392
		HP	kW					mmH ₂ O	40,5	40,5	43	45	44	40
BLC 003	230M	0,25	0,18	1	2800	60	Portata Delivery (m3/h)	100	200	300	400	500	600	
	230+400T	0,25	0,18	0,9+0,6	2800	60		100	200	300	400	500	600	

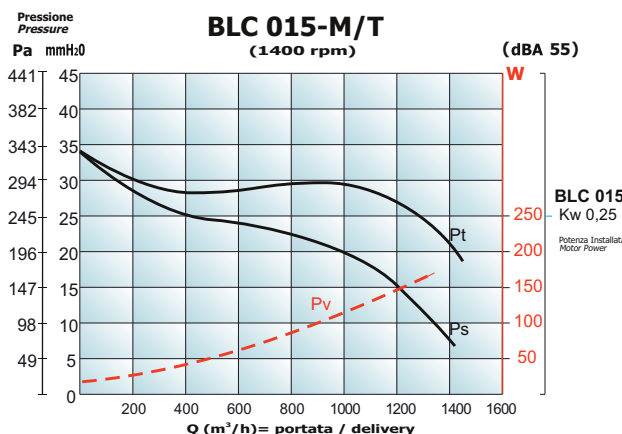
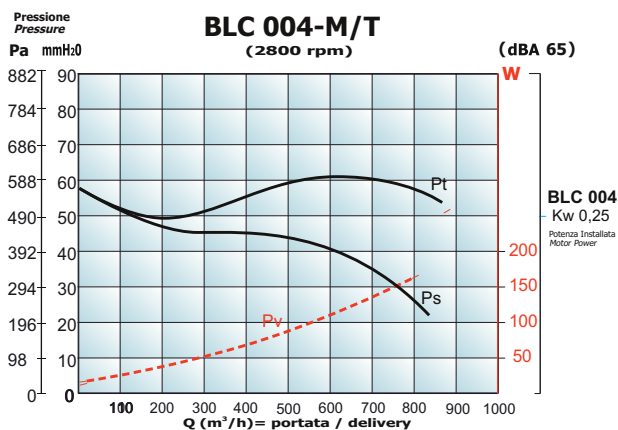

Modello Type	Voltage (V)	Potenza / Power		Assorbimento Absorption (A)	Giri/min. RPM	dBA	Pressione totale Total pressure	Pa	490	490	495	539	588	588	588	578	539
		HP	kW					mmH ₂ O	50	50	50,5	55	60	60	60	59	55
BLC 004	230M	0,35	0,25	2,2	2800	65	Portata Delivery (m3/h)	100	200	300	400	500	600	700	800	850	
	230+400T	0,35	0,25	1,3+0,8	2800	65		100	200	300	400	500	600	700	800	850	

Modello Type	Voltage (V)	Potenza / Power		Assorbimento Absorption (A)	Giri/min. RPM	dBA	Pressione totale Total pressure	Pa	294	284	284	294	294	265	196
		HP	kW					mmH ₂ O	30	29	29	30	30	27	20
BLC 015	230M	0,35	0,25	2,2	1400	55	Portata Delivery (m3/h)	200	400	600	800	1000	1200	1400	
	230+400T	0,35	0,25	0,3+0,8	1400	55		200	400	600	800	1000	1200	1400	

CORRENTE ALTERNATA (c.a.) / ALTERNATING CURRENT (a.c.)

PRESTAZIONI / PERFORMANCES

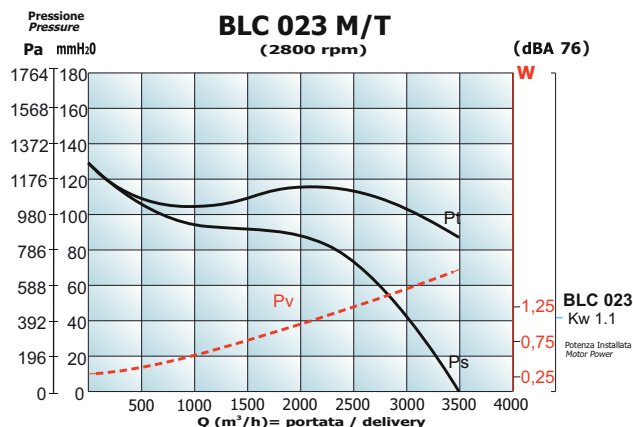
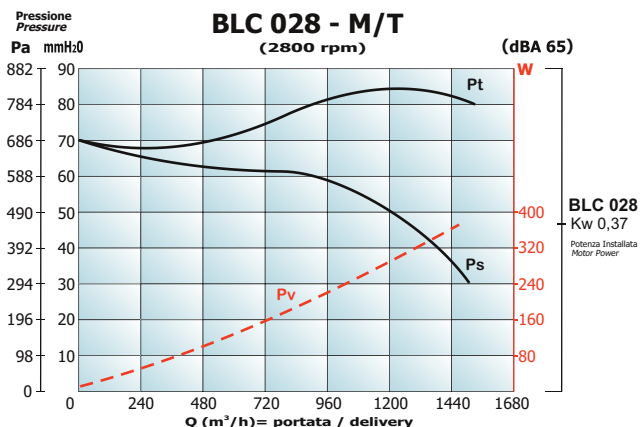

Modello Type	Voltaggio Voltage (V)	Potenza / Power		Assorbimento Absorption (A)	Giri/min. RPM	dBA	Pressione totale Total pressure	Pa	676,2	686	735	784	833	784
		HP	kW					mmH ₂ O	69	70	75	80	85	80
BLC 028	230M	0,5	0,37	2,8	2800	65	Portata Delivery (m ³ /h)	240	480	720	960	1200	1440	
	230+400T	0,5	0,37	1,5+0,9	2800	65		240	480	720	960	1200	1440	

Modello Type	Voltaggio Voltage (V)	Potenza / Power		Assorbimento Absorption (A)	Giri/min. RPM	dBA	Pressione totale Total pressure	Pa	1078	1029	1078	1127	1127	980	833
		HP	kW					mmH ₂ O	110	105	110	115	115	100	85
BLC 023	230M	1,5	1,1	7	2800	76	Portata Delivery (m ³ /h)	500	1000	1500	2000	2500	3000	3500	
	230+400T	1,5	1,1	5÷2,9	2800	76		500	1000	1500	2000	2500	3000	3500	

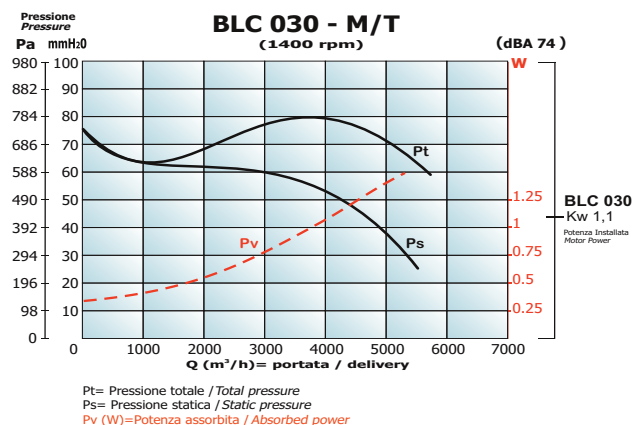
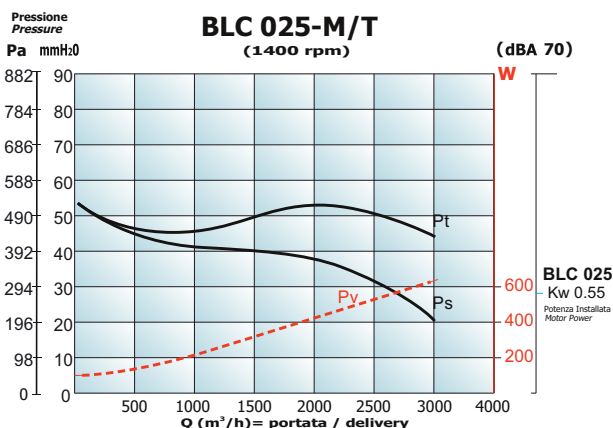

Modello Type	Voltaggio Voltage (V)	Potenza / Power		Assorbimento Absorption (A)	Giri/min. RPM	dBA	Pressione totale Total pressure	Pa	441	441	490	539	490	441
		HP	kW					mmH ₂ O	45	45	50	55	50	45
BLC 025	230M	0,75	0,55	5,2	1400	70	Portata Delivery (m ³ /h)	500	1000	1500	2000	2500	3000	
	230+400T	0,75	0,55	3,6÷2,2	1400	70		500	1000	1500	2000	2500	3000	

Modello Type	Voltaggio Voltage (V)	Potenza / Power		Assorbimento Absorption (A)	Giri/min. RPM	dBA	Pressione totale Total pressure	Pa	637	686	774	784	686	588
		HP	kW					mmH ₂ O	65	70	79	80	70	60
BLC 030	230M	1,5	1,1	7,2	1400	74	Portata Delivery (m ³ /h)	1000	2000	3000	4000	5000	5500	
	230+400T	1,5	1,1	5÷2,9	1400	74		1000	2000	3000	4000	5000	5500	

CORRENTE ALTERNATA (c.a.) / ALTERNATING CURRENT (a.c.)

PRESTAZIONI / PERFORMANCES

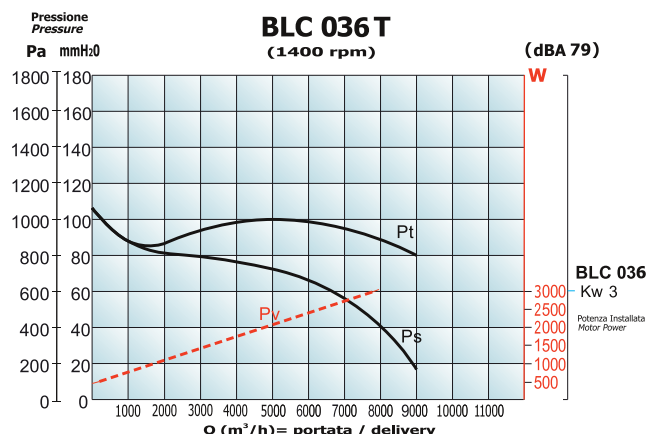
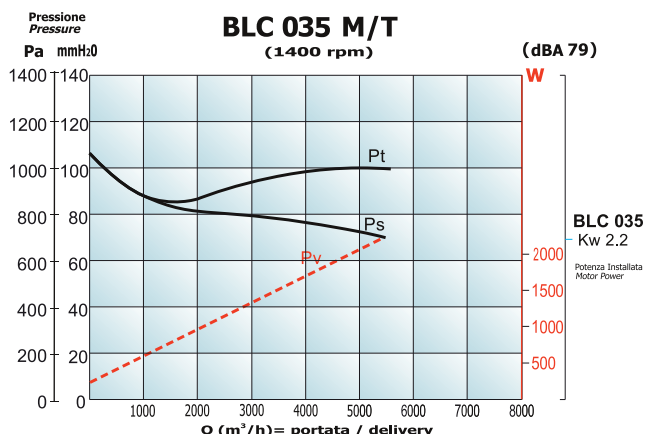

Modello Type	Voltage (V)	Potenza / Power		Assorbimento Absorption (A)	Giri/min. RPM	dBA	Pressione totale Total pressure	Pa	833	882	931	931	960	980
		HP	kW					mmH ₂ O	85	90	95	95	98	100
BLC 035	230M	3	2,2	13,5	1400	79	Portata Delivery (m3/h)	1000	2000	3000	3500	4500	5500	
	230+400T	3	2,2	9,2+5,4	1400	79		1000	2000	3000	3500	4500	5500	

Modello Type	Voltage (V)	Potenza / Power		Assorbimento Absorption (A)	Giri/min. RPM	dBA	Pressione totale Total pressure	Pa	882	931	980	980	931	882
		HP	kW					mmH ₂ O	90	95	100	100	95	90
BLC 036	230+400T	4	3	11,6+7	1400	79	Portata Delivery (m3/h)	1000	3000	4000	5000	7000	8000	

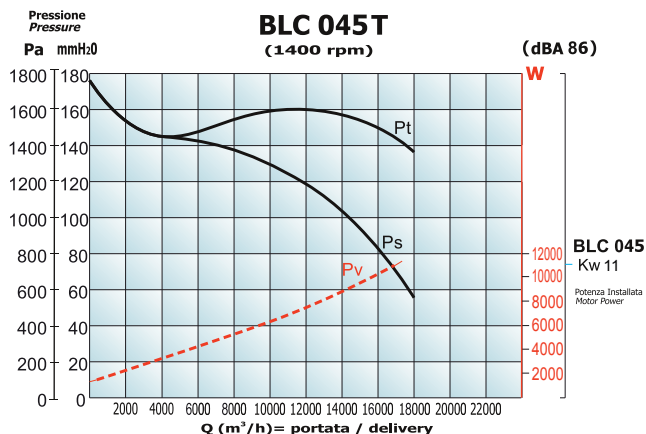
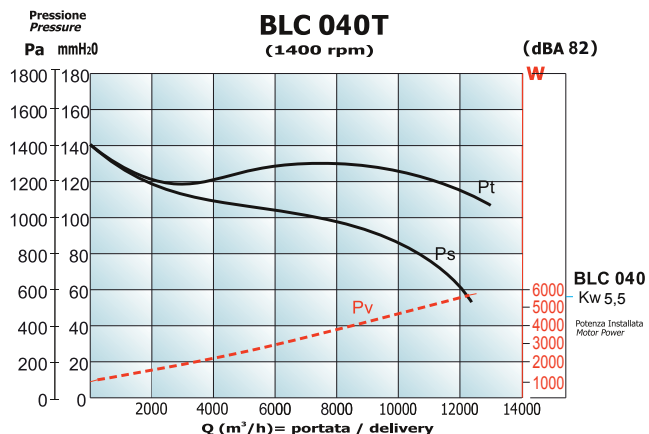

Modello Type	Voltage (V)	Potenza / Power		Assorbimento Absorption (A)	Giri/min. RPM	dBA	Pressione totale Total pressure	Pa	1274	1176	1176	1274	1323	1225	1176
		HP	kW					mmH ₂ O	130	120	120	130	135	125	120
BLC 040	230+400T	7,5	5,5	21+11,5	1400	82	Portata Delivery (m3/h)	1000	2000	4000	6000	8000	10000	11500	

Modello Type	Voltage (V)	Potenza / Power		Assorbimento Absorption (A)	Giri/min. RPM	dBA	Pressione totale Total pressure	Pa	1568	1470	1421	1470	1519	1568	1568	1548	1519	1470
		HP	kW					mmH ₂ O	160	150	145	150	155	160	160	158	155	150
BLC 045	400+690T	15	11	22+12,6	1400	86	Portata Delivery (m3/h)	1000	2000	4000	6000	8000	10000	12000	14000	15000	16000	

CORRENTE ALTERNATA (c.a.) / ALTERNATING CURRENT (a.c.)

DIMENSIONI E PESI / DIMENSIONS AND WEIGHTS

BLC

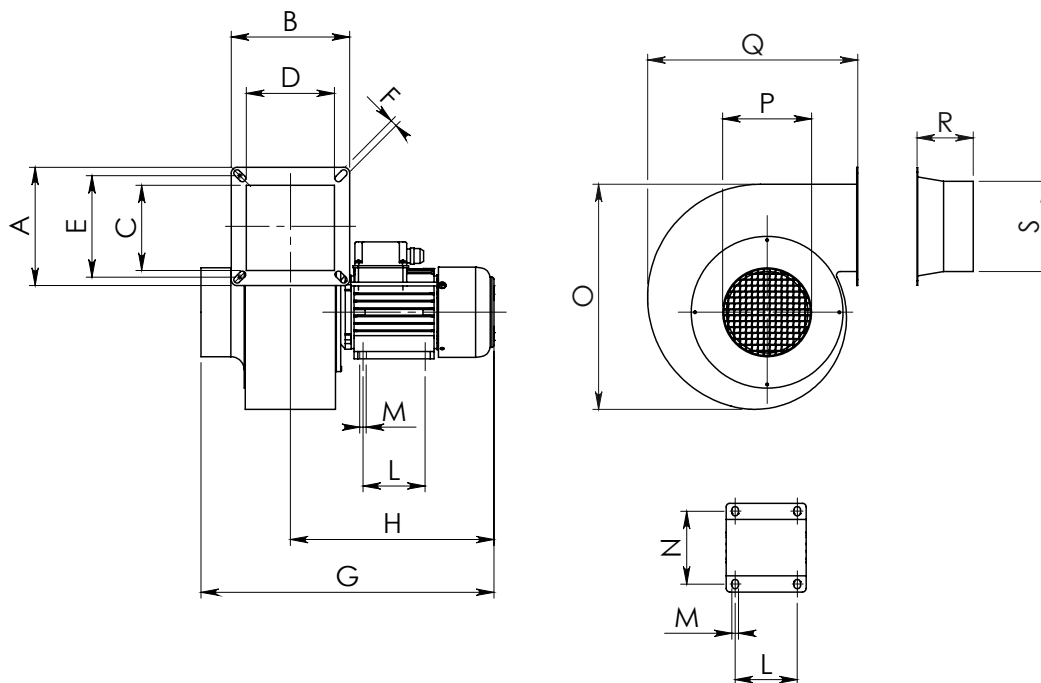

SUPPORTO MOTORE
(MOTOR SUPPORT)

Modello Type	Corrente Current	A	B	C	D	E	F	G	H	L	M	N	O	P	Q	R	S	Peso Weight (kg)
BLC 002	c.a. - a.c.	105	110	60	70	90	7	270	185	/	/	/	190	58	168	50	58	3
BLC 003	c.a. - a.c.	140	140	85	85	110	7	320	225	80	7	100	270	98	225	60	98	5,5
BLC 004	c.a. - a.c.	130	155	85	110	110	9	345	235	80	7	100	270	98	225	75	98	6
BLC 028	c.a. - a.c.	160	160	110	110	135	9	360	260	90	8	112	322	118	273	75	118	8
BLC 015	c.a. - a.c.	190	190	140	140	135	9	385	265	80	7	100	405	148	338	75	148	12
BLC 023	c.a. - a.c.	215	215	160	160	192	N°8 Ø11	480	280	100	10	125	420	200	340	150	160	22
BLC 025	c.a. - a.c.	255	255	200	200	232	N°8 Ø11	520	320	100	10	125	510	250	420	150	200	28
BLC 030	c.a. - a.c.	295	295	240	240	272	N°12 Ø11	580	355	125	10	140	610	300	500	200	240	38
BLC 035	c.a. - a.c.	345	345	280	280	318	N°12 Ø11	680	434	140	12	190	715	350	580	200	280	62
BLC 036	c.a. - a.c.	345	345	280	280	318	N°12 Ø11	680	434	140	12	190	715	350	580	200	280	62
BLC 040	c.a. - a.c.	385	385	320	320	358	N°12 Ø11	812	546	178	12	216	830	400	660	200	320	112
BLC 045	c.a. - a.c.	425	425	360	360	400	N°16 Ø11	955	667	254	15	254	920	450	740	200	360	195

Misure in millimetri (mm), dimensioni non impegnative / Measures in millimeter (mm), dimensions approximated

