

Springfield Marine

About Springfield Marine

Springfield Aluminum Company was founded in 1952 by Garnett Carnahan as an aluminum foundry and quickly found itself in a new emerging marine market that developed across the USA. By the late 1970's, the marine industry was the primary customer base that allowed Springfield Marine to develop as a brand of marine seating hardware. Springfield Marine has pioneered the marine seating industry with innovative designs that have allowed numerous patents and design acknowledgments that still hold the brand strong today. Springfield Marine continues to develop products to meet the growing needs of the marine industry while maintaining durability for safety, stability, and comfort.

Springfield Marine Company has been doing business in China since 1990. Our state of the art facility in Jiangsu offers nearly 70,000 M² of in-house product designs and manufacturing, molding, and logistic services. To ensure quality and customer satisfaction, we have continuously obtained the following authentications:

- Certificate of type approval of China Classification Society (CCS)
- DNV Business Assurance Management System Certificate (DNV)
- Type Approval Certificate (BV)
- EC Type-Examination Certificate
- ABYC H-31 Classifications (USA)

Our goal is to establish long term relationships to help grow and increase your market shares, as well as provide top of the line products that offer the comfort and safety your customers demand.

Warranty Information



HARDWARE: 5 Year Limited Warranty: Hardware (Pedestals, Mounts & Accessories)

For a period of 5 years from the date of sale to the first use purchaser, SPRINGFIELD MARINE CO. will repair or replace, at our discretion, any product which proves to have manufacturer's defect in materials and workmanship under normal and proper usage.



SEATING: 1 Year Limited Warranty: Upholstery & Cushions.

(Upholstery & cushions) For a period of 1 year from the date of sale to the first use purchaser, SPRINGFIELD MARINE CO. will repair or replace, at our discretion, any upholstered product which proves to have manufacturer's defect involving vinyl, fabric, leather or foam components in materials and workmanship under normal and proper usage.



SEATING: 5 Year Limited Warranty: Frame & Substrate.

(Frame & substrate) For a period of 5 years from the date of sale to the first use purchaser, SPRINGFIELD MARINE CO. will repair or replace, at our discretion, any seating product which proves to have manufacturer's defect involving frame or substrate components in materials and workmanship under normal and proper usage.

THIS WARRANTY DOES NOT EXTEND TO CONSEQUENTIAL DAMAGES. (Some states do not allow the exclusion or limitation of incidental or consequential damages, so the above limitation or exclusion may not apply to you.)

The foregoing is the only warranty or representation made, express or implied, and specifically there is NO WARRANTY OF MERCHANTABILITY and NO WARRANTY OF FITNESS FOR A PARTICULAR PURPOSE.

SPRINGFIELD MARINE CO. is not liable for improper installation or improper use of the product or any failure or problems from lack of reasonable maintenance, racing activities, or commercial applications.

THIS WARRANTY SHALL BE CONSIDERED VOID IF, The seat or any accessory/equipment has been altered, modified, changed or reworked, subjected to abuse, neglect, or accident, including abnormal use, the seat is installed in a manner that would subject the seat to abnormal use. THIS WARRANTY IS VOID IF MIXING SPRINGFIELD MARINE COMPONENTS WITH NON-SPRINGFIELD MARINE PARTS.

In order to obtain service under the warranty, the customer must notify our customer service department to obtain a return authorization, Phone: (417) 725-2667

SPRINGFIELD MARINE CO.
Attn: Returns (Your RA#)
1093 N. Cynthia Drive
Nixa, MO 65714

Our dealers and distributors are not authorized to modify the warranty in any respect.

SPRINGFIELD MARINE's continuing program of product development and improvement makes specifications, colors, standard features, designs, prices and availability subject to change without notice or obligation. See your Springfield Marine dealer for current information.

These products are not designed or warranted for racing or high performance use.

NOTE: COMMERCIAL USE RESTRICTIONS APPLY. CONTACT US FOR DETAILS.

Customers are responsible for paying return freight as well as the freight on a new order if you are making an exchange. Springfield Marine is not responsible for lost items in return shipping so please insure your package.

Product Catalog

Table of Contents

Seating	4 - 31
<small>FOLDING SEATS • STAND-UP SEATS • MOLDED SEATS • UPHOLSTERED SEATS • HELM SEATS</small>	
KingPin™	32 - 39
<small>PACKAGES • SEAT MOUNTS • POSTS • BASES • ACCESSORIES</small>	
Taper-Lock™	40 - 44
<small>PACKAGES • SEAT MOUNTS • POSTS • BASES • ACCESSORIES</small>	
Plug-In™	45 - 50
<small>PACKAGES • SEAT MOUNTS • POSTS • BASES • ACCESSORIES</small>	
Thread-Lock™	51 - 53
<small>PACKAGES • SEAT MOUNTS • POSTS • BASES • ACCESSORIES</small>	
Spring-Lock™ & Clip-Lock	54 - 59
<small>PACKAGES • SEAT MOUNTS • POSTS • BASES • ACCESSORIES</small>	
2-3/8" Series	60 - 65
<small>PEDESTAL PACKAGES • SLIDES & SWIVELS • PEDESTALS</small>	
2-7/8" Series	66 - 72
<small>PEDESTAL PACKAGES • SLIDES & SWIVELS • PEDESTALS</small>	
4" Series	73 - 76
<small>PEDESTAL PACKAGES • SLIDES & SWIVELS • PEDESTALS</small>	
Wave Dampening	77 - 79
<small>EZ-RIDE PEDESTALS • SHOCKER PEDESTALS • GRAMMER AVENTO SYSTEMS</small>	
Mounting Systems	80 - 87
<small>MOUNTING SLIDES • MOUNTING SWIVELS • MOUNTING RAILS • MOUNTING POSTS</small>	
Barbecue Grills & Tables	88 - 99
<small>BARBECUE GRILLS • TABLE PACKAGES • TABLE TOPS • MOUNTS • POSTS • BASES</small>	
Accessories	100 - 110
<small>ARMRESTS • FOOTRESTS • DECK PLATES • SKI TOWS • MOTOR MOUNTS</small>	

Please note that the actual products may differ slightly from specifications and/or the pictures contained in our catalog, web site, viewing areas or order forms. Thus, Springfield Marine is not responsible for typographical, pricing, product information, advertising or shipping errors.

SEATING SYSTEMS
KNIGPIN™
TAPER-LOCK™
PLUG-IN™
THREAD-LOCK™
SPRING-LOCK™ & CLIP-LOCK
2-3/8" SERIES
2-7/8" SERIES
4" SERIES
WAVE DAMPENING
MOUNTING SYSTEMS
BARBECUE GRILLS & TABLES
ACCESSORIES
PART NUMBER INDEX

Seating Systems

ABOUT SEATING SYSTEMS

Springfield Marine knows that comfort is important in marine seating. Whether behind the wheel for long passages in rough water, dropping a line in a quiet creek, or anywhere in between. Springfield Marine offers a wide range of configurations and options.

Quality, comfort, and strength add up to value, and value is an important consideration in choosing the best seating system that's right for you. Our wide variety of chairs and even greater choice of seating hardware provide an array of combinations second to none.

Matching the chair with the correct seating hardware is also an important consideration in product selection. So whether selecting one of our seating packages or making your own combinations, Springfield Marine offers the right product to meet a wide range of needs.

FOLDING SEATS • STAND-UP SEATS • MOLDED SEATS • UPHOLSTERED SEATS • HELM SEATS



Seating Systems

FISH PRO II HIGH BACK

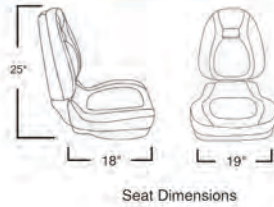

Image	Part Number	Description	Pack Quantity
A.	1041883	Fish Pro II, High-Back - Gray & Black	1 Pack
B.	1041819	Fish Pro II, High-Back - Navy & White	1 Pack
C.	1041800-SF	Fish Pro II, High-Back - Substrate & Foam	10 Pack

Premium upholstery and cushions are designed to provide maximum comfort and quality. Backrest is fitted with ergonomically molded cushions and extended sides for extra support. Durable injection molded shell with hinge allows seat to fold down flat.

- High Back - Folds down easily
- Weather resistant marine grade vinyl
- Universal mounting pattern 5" x 12"



Folded Position

Folding Seats

FISH PRO II LOW BACK

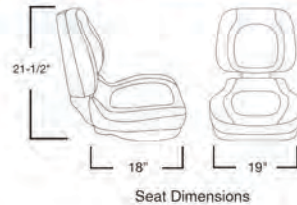
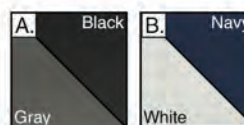

Image	Part Number	Description	Pack Quantity
A.	1041983	Fish Pro II, Low-Back - Gray & Black	1 Pack
B.	1041919	Fish Pro II, Low-Back - Navy & White	1 Pack
C.	1041900-SF	Fish Pro II, Low-Back - Substrate & Foam	10 Pack

Premium upholstery and cushions are designed to provide maximum comfort and quality. Backrest is fitted with ergonomically molded cushions and extended sides for extra support. Durable injection molded shell with hinge allows seat to fold down flat.

- Low Back - Folds down easily
- Weather resistant marine grade vinyl
- Universal mounting pattern 5" x 12"



Folded Position

FISH PRO HIGH BACK

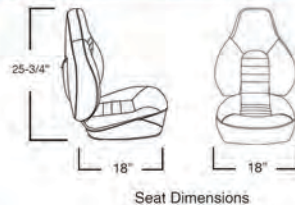

D: Foam & Substrate Only

Image	Part Number	Description	Pack Quantity
A.	1041602	Fish Pro, Folding Seat - Black	1 Pack
B.	1041603	Fish Pro, Folding Seat - Gray	1 Pack
C.	1041606	Fish Pro, Folding Seat - White	1 Pack
D.	1041620	Fish Pro, Substrate & Foam Only	1 Pack
E.	1041631	Fish Pro, Folding Seat - Blue & Gray	1 Pack
F.	1041633	Fish Pro, Folding Seat - Charcoal & Gray	1 Pack
G.	1041635	Fish Pro, Folding Seat - Red & Gray	1 Pack

Exceptional high back contour lumbar cushion cradles your back for maximum support. Designed for style, comfort, and durability. Optional armrests can be added (sold separately). Deep pocket on back of seat.

- Concealed pinch proof hinges
- Weather resistant marine grade vinyl
- Universal mounting pattern: 5" x 5" & 5" x 12"

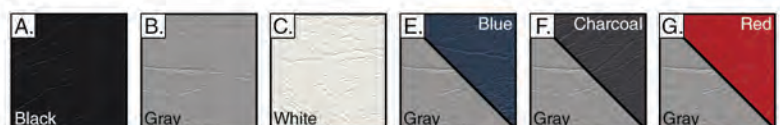

Seating Systems

Folding Seats

FISH PRO LOW BACK

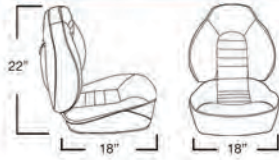

Seat Dimensions

Image	Part Number	Description	Pack Quantity
A.	1041636	Fish Pro Mid Back, Folding Seat - White	1 Pack
B.	1041731	Fish Pro Mid Back, Folding Seat - Blue & Gray	1 Pack
C.	1041733	Fish Pro Mid Back, Folding Seat - Charcoal & Gray	1 Pack

Contour lumbar cushion cradles your back for maximum support. Designed for style, comfort, and durability. Deep mesh pocket on back of seat.

- Folds down easily
- Concealed pinch proof hinges
- Weather resistant marine grade vinyl
- Universal mounting pattern: 5" x 5" & 5" x 12"

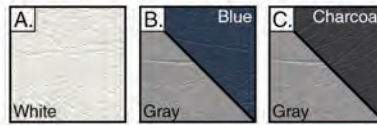

Folded Position

SKIPPER PREMIUM HB



Seat Dimensions

Image	Part Number	Description	Pack Quantity
A.	1061061	Skipper High Back, Folding Seat - Mossy Oak™ Duck Blind	1 Pack
B.	1061065	Skipper High Back, Folding Seat - Ozone & Meteor	1 Pack
C.	1061067	Skipper High Back, Folding Seat - Charcoal & Gray w/ Meteor	1 Pack
D.	1061069	Skipper High Back, Folding Seat - Blue & Gray w/ Meteor	1 Pack

External injection molded frame for structural support. Premium high quality upholstery and cushions for maximum support and comfort. Subtle curves provide lumbar support. Weather resistant marine grade vinyl.

- Premium High Back seat
- Folds down easily
- Optimal UV protection
- T-nuts installed into seat for better mounting durability
- Universal Mounting Pattern: 5" x 5" & 5" x 12"

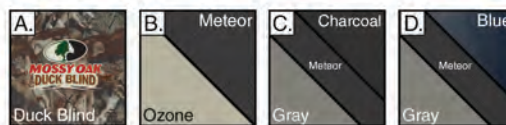

SKIPPER PREMIUM LB



Seat Dimensions

Image	Part Number	Description	Pack Quantity
A.	1061071	Skipper Low Back, Folding Seat - Mossy Oak™ Duck Blind	1 Pack
B.	1061075	Skipper Low Back, Folding Seat - Ozone & Meteor	1 Pack
C.	1061077	Skipper Low Back, Folding Seat - Charcoal & Gray w/ Meteor	1 Pack
D.	1061079	Skipper Low Back, Folding Seat - Blue & Gray w/ Meteor	1 Pack

External injection molded frame for structural support. Premium high quality upholstery and cushions for maximum support and comfort. Subtle curves provide lumbar support. Weather resistant marine grade vinyl.

- Premium Low Back seat
- Folds down easily
- Optimal UV protection
- T-nuts installed into seat for better mounting durability
- Universal Mounting Pattern: 5" x 5"

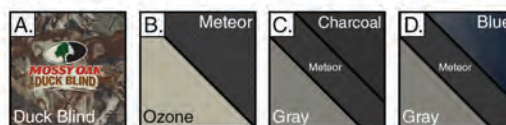

SKIPPER DELUXE SEATS

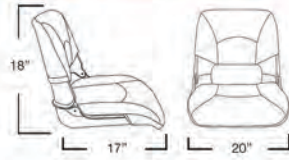

Seat Dimensions

Image	Part Number	Description	Pack Quantity
A.	1061045	Skipper, White Shell w/ Brown & White Cushions	1 Pack
B.	1061057	Skipper, Gray Shell w/ Charcoal & Gray Cushions	1 Pack

Injection molded seats with interlocking hinge for greater structural support. Extra wide seat with high quality synthetic boat fabric for all day comfort.

- Folds down easily
- Universal mounting pattern: 5" x 5", & 5" x 12"
- T-nuts installed into seats for better mounting durability

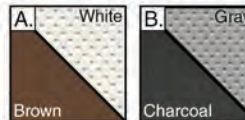

SKIPPER STANDARD

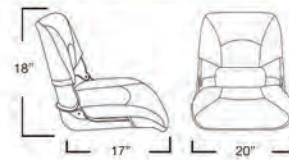

Seat Dimensions

Image	Part Number	Description	Pack Quantity
A.	1061016	Skipper, White Shell w/ White & Blue Cushions	1 Pack
B.	1061017	Skipper, Gray Shell w/ Gray & Charcoal Cushions	1 Pack
C.	1061018	Skipper, Gray Shell w/ Gray & Red Cushions	1 Pack
D.	1061019	Skipper, Gray Shell w/ Gray & Blue Cushions	1 Pack
E.	1061025	Skipper, White Shell w/ White Cushions	1 Pack

Injection molded seats with interlocking hinge for greater structural support. Extra wide seat with high quality upholstery for all day comfort.

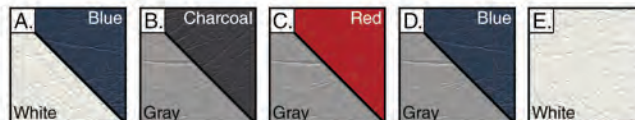

SKIPPER CAMO

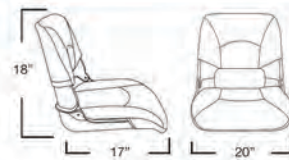

Seat Dimensions

Image	Part Number	Description	Pack Quantity
A.	1061020	Skipper, Black Shell w/ Mossy Oak™ Break-Up Cushions	1 Pack
B.	1061021	Skipper, Black Shell w/ Mossy Oak™ Duck Blind Cushions	1 Pack

Injection molded seats with interlocking hinge for greater structural support. Extra wide seat with premium high quality camouflage upholstery.



SKIPPER SHELLS

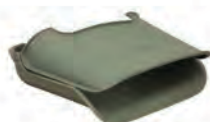

Folded Position

Image	Part Number	Description	Pack Quantity
A.	1061015-S	Skipper, Fold Down Shell - Gray	1 Pack
B.	1061015-SB	Skipper, Fold Down Shell - Black	1 Pack
C.	1061015-SG	Skipper, Fold Down Shell - Green	1 Pack
D.	1061015-SW	Skipper, Fold Down Shell - White	1 Pack
A.	1061015-M	Skipper, Fold Down Shell - Gray	10 Pack
E.	1061015-MS	Skipper, Fold Down Shell - Sand	10 Pack

Injection molded seats with interlocking hinge for greater structural support.

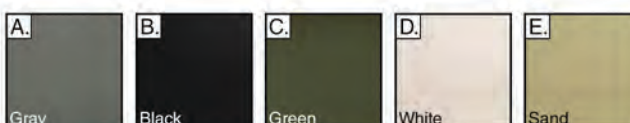

Seating Systems

Folding Seats

TRAVELER MULTI COLOR

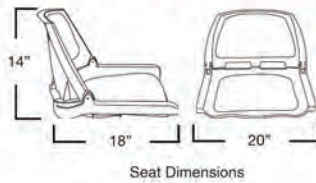
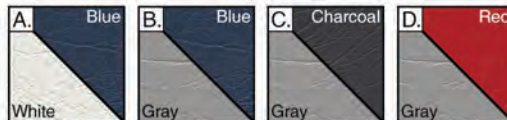

Image	Part Number	Description	Pack Quantity
A.	1061117-C	Traveler, White Shell w/ White & Blue Cushions	2 Pack
B.	1061121-C	Traveler, Gray Shell w/ Blue & Gray Cushions	2 Pack
C.	1061123-C	Traveler, Gray Shell w/ Charcoal & Gray Cushions	2 Pack
D.	1061125-C	Traveler, Gray Shell w/ Red & Gray Cushions	2 Pack

Super strong copolymer frame with extra wide contoured seat and curved back.

- Durable strap holds seat closed when folded down
- Universal mounting pattern: 5.25" x 5.25"



TRAVELER STANDARD

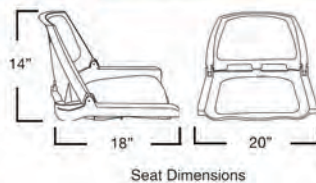

Image	Part Number	Description	Pack Quantity
A.	1061100-C	Traveler, Gray Shell w/ Gray Cushions	2 Pack
B.	1061101-C	Traveler, Brown Shell w/ Tan Cushions	2 Pack
C.	1061103-C	Traveler, Black Shell w/ Black Cushions	2 Pack
D.	1061104-C	Traveler, White Shell w/ White Cushions	2 Pack
E.	1061105-C	Traveler, Green Shell w/ Green Cushions	2 Pack
F.	1061112-C	Traveler, Gray Shell w/ Blue Cushions	2 Pack
G.	1061113-C	Traveler, Gray Shell w/ Charcoal Cushions	2 Pack
H.	1061114-C	Traveler, Gray Shell w/ Red Cushions	2 Pack



TRAVELER CAMO

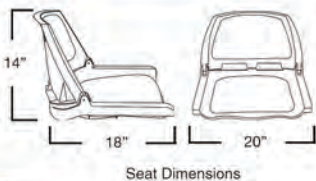

Image	Part Number	Description	Pack Quantity
A.	1061106-C	Traveler, Green Shell w/ Mossy Oak™ Break-Up Cushions	2 Pack
B.	1061107-C	Traveler, Green Shell w/ Mossy Oak™ Duck Blind Cushions	2 Pack
C.	1061108-C	Traveler, Brown Shell w/ Mossy Oak™ Break-Up Cushions	2 Pack



TRAVELER SHELLS



Image	Part Number	Description	Pack Quantity
A.	1061100-S	Traveler, Fold Down Shell - Gray	2 Pack
B.	1061101-S	Traveler, Fold Down Shell - Brown	2 Pack
C.	1061103-S	Traveler, Fold Down Shell - Black	2 Pack
D.	1061104-S	Traveler, Fold Down Shell - White	2 Pack
E.	1061105-S	Traveler, Fold Down Shell - Green	2 Pack

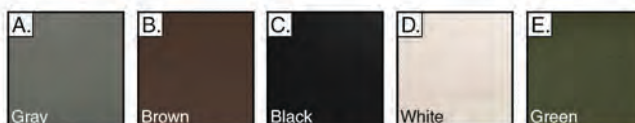

OEM SERIES FOLDING

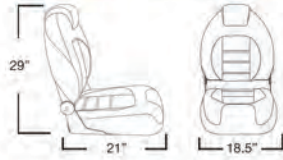

Seat Dimensions

Image	Part Number	Description	Pack Quantity
A.	1062583	OEM Series, Folding Seat - Charcoal & Tan	1 Pack

Premium high quality upholstery and cushions with rigid injection molded frame.

- Folds down easily
- Heavy-duty pinchless hinges
- Weather resistant marine grade vinyl

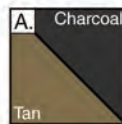

Heavy-Duty Pinchless Hinge



Folded View

PREMIUM WAVE

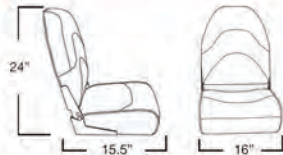

Seat Dimensions

Image	Part Number	Description	Pack Quantity
A.	1062031	Premium Folding - Gray w/ Blue & Meteor Stripe	1 Pack
B.	1062034	Premium Folding - Gray w/ Meteor Stripe	1 Pack
C.	1062089	Premium Folding - Ozone White w/ Meteor Stripe	1 Pack

Premium high quality upholstery and cushions with rigid injection molded frame for maximum support and comfort. Durable strap with snap keeps seat closed when folded down.

- Folds down easily
- Pinchless hinges
- Weather resistant marine grade vinyl
- Optimal UV protection

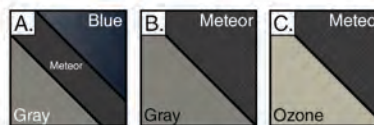

Folded View

PREMIUM STANDARD

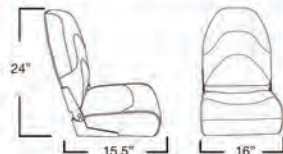

Seat Dimensions

Image	Part Number	Description	Pack Quantity
A.	1062131	Premium Folding - Gray & Blue	1 Pack
B.	1062134	Premium Folding - Gray & Meteor	1 Pack

Premium high quality upholstery and cushions with rigid injection molded frame for maximum support and comfort. Durable strap with snap keeps seat closed when folded down.

- Folds down easily
- Pinchless hinges
- Weather resistant marine grade vinyl
- Optimal UV protection

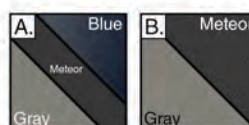

Folded View

Seating Systems

Folding Seats

HIGH BACK MULTI COLOR



Seat Dimensions

Image	Part Number	Description	Pack Quantity
A.	1040661	High Back, Folding Seat - Gray & Blue	1 Pack
B.	1040663	High Back, Folding Seat - Gray & Charcoal	1 Pack
C.	1040665	High Back, Folding Seat - Gray & Red	1 Pack
D.	1040667	High Back, Folding Seat - White & Blue	1 Pack
E.	1040668	High Back, Folding Seat - Sand & Brown	1 Pack

Now a comfortable cushioned high back seat to support your backside. Rigid injection molded frame. Durable strap to keep seat secure when folded down

- Folds down easily
- Weather resistant marine grade vinyl
- Heavy-duty powder coated hinges
- Universal mounting pattern: 5" x 5"

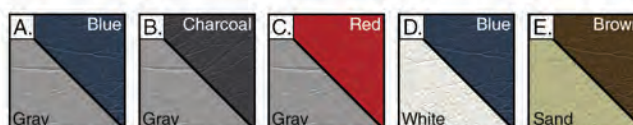

HIGH BACK STANDARD



Seat Dimensions

Image	Part Number	Description	Pack Quantity
A.	1040634	High Back, Folding Seat - Charcoal	1 Pack
B.	1040636	High Back, Folding Seat - Brown	1 Pack
C.	1040642	High Back, Folding Seat - Green	1 Pack
D.	1040643	High Back, Folding Seat - Gray	1 Pack
E.	1040649	High Back, Folding Seat - White	1 Pack

Now a comfortable cushioned high back seat to support your backside. Rigid injection molded frame. Durable strap to keep seat secure when folded down

- Folds down easily
- Weather resistant marine grade vinyl
- Heavy-duty powder coated hinges
- Universal mounting pattern: 5" x 5"

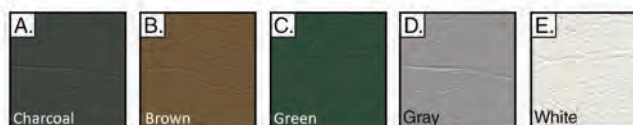

HIGH BACK CAMO



Seat Dimensions

Image	Part Number	Description	Pack Quantity
A.	1040646	High Back, Folding Seat - Mossy Oak™ Break-Up	1 Pack
B.	1040647	High Back, Folding Seat - Mossy Oak™ Duck Blind	1 Pack

Now a comfortable cushioned high back seat to support your backside. Rigid injection molded frame. Durable strap to keep seat secure when folded down

- Folds down easily
- Weather resistant marine grade vinyl
- Black e-coat hinges
- Universal mounting pattern: 5" x 5"



Folded View

ECONOMY MULTI COLOR



Seat Dimensions

Image	Part Number	Description	Pack Quantity
A.	1040651	Economy, Folding Seat - Gray & Blue	1 Pack
B.	1040653	Economy, Folding Seat - Gray & Charcoal	1 Pack
C.	1040655	Economy, Folding Seat - Gray & Red	1 Pack
D.	1040658	Economy, Folding Seat - Sand & Brown	1 Pack

Comfortable cushioned seat to support your backside. Strap with snap to keep seat secure when folded down. Rigid injection molded frame.

- Folds down easily
- Heavy-duty powder coated hinges
- Universal mounting pattern: 5" x 5"

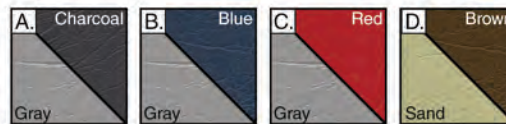

ECONOMY STANDARD

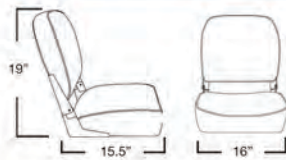

Seat Dimensions

Image	Part Number	Description	Pack Quantity
A.	1040611	Economy, Folding Seat - Light Blue	1 Pack
B.	1040616	Economy, Folding Seat - Brown	1 Pack
C.	1040621	Economy, Folding Seat - Blue	1 Pack
D.	1040622	Economy, Folding Seat - Green	1 Pack
E.	1040623	Economy, Folding Seat - Gray	1 Pack
F.	1040624	Economy, Folding Seat - Charcoal	1 Pack
G.	1040625	Economy, Folding Seat - Red	1 Pack
H.	1040628	Economy, Folding Seat - Tan	1 Pack
I.	1040629	Economy, Folding Seat - White	1 Pack

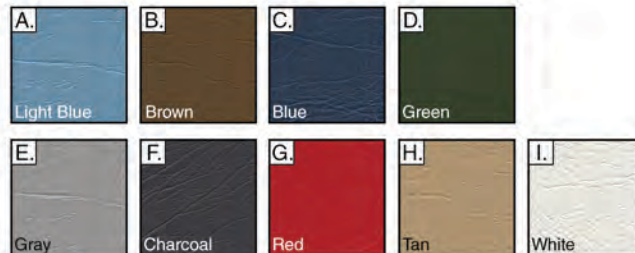

ECONOMY CAMO

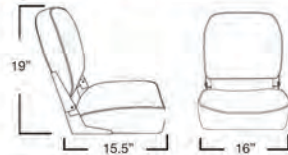

Seat Dimensions

Image	Part Number	Description	Pack Quantity
A.	1040626	Economy Camo, Folding Seat - Mossy Oak™ Break-Up	1 Pack
B.	1040627	Economy Camo, Folding Seat - Mossy Oak™ Duck Blind	1 Pack

Comfortable cushioned seat to support your backside. Strap with snap to keep seat secure when folded down. Rigid injection molded frame.

- Folds down easily
- Black e-coated hinges
- Universal mounting pattern: 5" x 5"



Folded View

Seating Systems

Folding Seats

XXL FOLDING SEAT

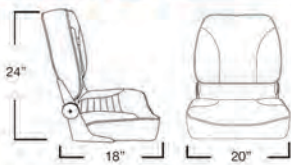

Seat Dimensions

Image	Part Number	Description	Pack Quantity
A.	1040691	XXL, Folding Seat - Gray & Navy	1 Pack
B.	1040693	XXL, Folding Seat - Charcoal & Gray	1 Pack
C.	1040697	XXL, Folding Seat - Mossy Oak™ Duck Blind	1 Pack

Designed for the plus size body frames. Marine grade vinyl with plush foam padding. Heavy-duty powder coated hinges. Strap with snap to keep seat secure when folded down.

- Folds down easily
- Extra wide seat
- Heavy-duty pinchless hinges
- Optional armrests: 1041004 (sold separately)

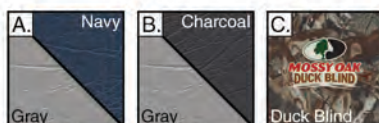

Heavy-Duty Pinchless Hinge

SKIPPER PACKAGE



Rated ABYC Class H-31 AD



Seat Dimensions

Image	Part Number	Description	Pack Quantity
A.	1001003	Skipper Chair Package w/ Cushions	1 Pack

Skipper Chair Package Includes:

- Skipper injection molded seat with cushions
- 15" fixed height pedestal with 9" floor base, anodized finish
- Locking Trac-Lock™ swivel, rotates 360°

Dimensions are from deck to top of pedestal, and may vary slightly.



Skipper Folding Seat



Trac-Lock™ Locking Swivel (AD)



Second Generation Locking Pedestal

TRAVELER PACKAGE



Rated ABYC Class H-31 B



Seat Dimensions

Image	Part Number	Description	Pack Quantity
A.	1061100	Traveler Chair Package w/ Cushions	1 Pack

Traveler Chair Package Includes:

- Traveler fold down seat with cushions
- 15" fixed height pedestal with 9" floor base, anodized finish
- KingPin™ seat mount with e-coat finish and rotates 360°

Dimensions are from deck to top of pedestal, and may vary slightly.



Traveler Folding Seat



KingPin™ Seat Mount (B)



Explorer Non-Locking Pedestal

DECK CHAIR CLASSIC



Seat Dimensions

Image	Part Number	Description	Pack Quantity
A.	1080021	Deck Folding Chair - Standard	1 Pack
B.	1080021-EMB	Deck Folding Chair - Embroidered Sail Fish	1 Pack
C.	1080022	Deck Folding Chair - With Gimbal	1 Pack

Take these chairs wherever you go. Perfect for picnics, decks, docks or the action station for the fighting fisherman. Folds down easily for transportation.

- Durable plastic substrate
- Heavy-duty aluminum tubing
- Weather resistant marine grade vinyl
- Hand embroidered sail fish (EMB only)

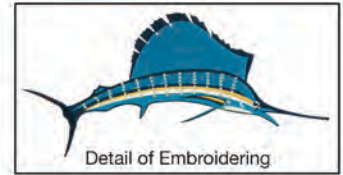

Detail of Embroidering

Deck Seats

DECK CHAIR STAINLESS

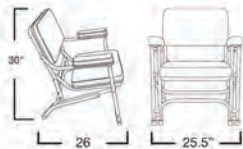

Seat Dimensions

Image	Part Number	Description	Pack Quantity
A.	1080021-SS	Deck Folding Chair - Stainless Steel Tubing	1 Pack
B.	2100300	Bolt On Gimbal	1 Pack

Dual 1" stainless steel tubing, eight legged frame with rubber capped feet for extra stability. Folds down easily for transportation.

- Durable plastic substrate
- Stainless steel tubing
- Weather resistant marine grade vinyl



Bolt on Gimbal 2100300
Fits Any Deck Chair (Available Separate)

DECK CHAIR EURO



Seat Dimensions

Image	Part Number	Description	Pack Quantity
A.	1080121	Deck Folding Chair - European Style	1 Pack

Folds flat, locking bar keeps legs locked in place for extra stability. Can be used with or without cushions. Includes back and seat cushions.

- Cushions are removable
- Weather resistant marine grade vinyl
- Plastic armrests



Shown with cushions removed

Seating Systems

STAND-UP SEATS

Stand-Up Seats

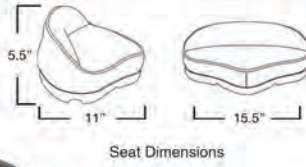

Seat Dimensions



Pro Stand-Up Seat



Stand-Up Seat

Image	Part Number	Description	Pack Quantity
A.	1040211	Pro Stand-Up Seat - Blue	1 Pack
B.	1040212	Pro Stand-Up Seat - Black	1 Pack
C.	1040213	Pro Stand-Up Seat - Gray	1 Pack
D.	1040214	Pro Stand-Up Seat - Tan	1 Pack
E.	1040215	Pro Stand-Up Seat - Red	1 Pack
F.	1040216	Pro Stand-Up Seat - White	1 Pack
G.	1040217	Pro Stand-Up Seat - Mossy Oak™ Duck Blind	1 Pack
H.	1040219	Pro Stand-Up Seat - Charcoal	1 Pack
B.	1040212-NS	Stand-Up Seat, Economy - Black	1 Pack
C.	1040213-NS	Stand-Up Seat, Economy - Gray	1 Pack
F.	1040216-NS	Stand-Up Seat, Economy - White	1 Pack
I.	1030200	Stand-Up Seat, Substrate Only	1 Pack

Bicycle style seat comes with foam padding covered in marine grade vinyl. Plastic substrate; no more wood to rot out! Compact desing allows for more room when standing up to fish. Whether you sit or lean against this seat, it provides comfort and stability.

- Available in a variety of colors
- Universal mounting pattern: 5" x 5"

Pro Stand-Up seats include external cover for comfort.

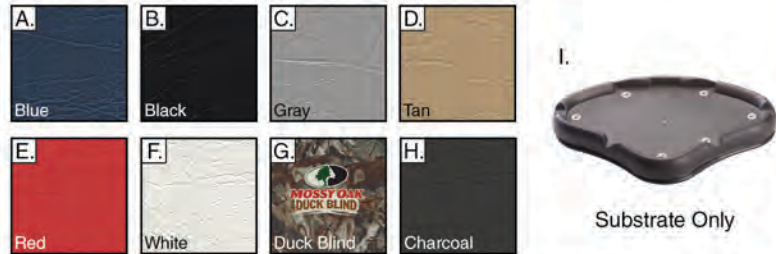

CONTROL POSTS



Image	Part Number	Description	Pack Quantity
A.	1040350-SL	Spring-Lock™ Control Post, Charcoal Gray Seat	1 Pack
A.	1040351-SL	Spring-Lock™ Control Post, Mica Tan Seat	1 Pack
B.	1040352-PIC	Plug-In™ Control Post, Charcoal Gray Seat	1 Pack
B.	1040352-PIM	Plug-In™ Control Post, Mica Tan Seat	1 Pack
C.	1040353-TLC	Taper-Lock™ Control Post, Charcoal Gray Seat	1 Pack
C.	1040352-TLM	Taper-Lock™ Control Post, Mica Tan Seat	1 Pack
D.	1040355-KPC	KingPin™ Control Post, Charcoal Gray Seat - Threaded	1 Pack
D.	1040355-KPM	KingPin™ Control Post, Mica Tan Seat - Threaded	1 Pack
E.	1040357-KPC	KingPin™ Control Post, Charcoal Gray Seat - Standard	1 Pack
E.	1040357-KPM	KingPin™ Control Post, Mica Tan Seat - Standard	1 Pack

From a completely flat position to 90° upright, the Control Post adjusts in every direction for complete comfort during even the longest days on the water.

Packed in box for retail presentation.



Rated ABYC Class H-31 B

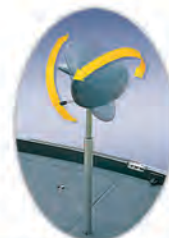

FIRST MATE *MOLDED*



Seat Dimensions

Image	Part Number	Description	Pack Quantity
A.	1061014-S	First Mate, Molded Seat - Gray	6 Pack
B.	1061014-SG	First Mate, Molded Seat - Green	6 Pack

First Mate molded seats are one piece molded shells, made from PP plastic. Durable and lightweight, for years of carefree use.

- Durable plastic
- Universal mounting pattern: 5" x 5"
- Stack for retail presentation

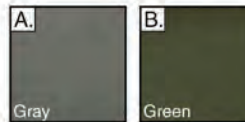

Molded Seats

ROTATIONAL *MOLDED*

One piece white molded shell, made from LLDPE plastic with UV inhibitors for years of carefree use. Available in a variety of shapes and styles.

For proper support use mounting plate #3100207 or any Trac-Lock™ slide (sold separately).

Seat cushions are available in off white for each seat style. Cushions are made from plush foam padding covered with marine grade vinyl. Designed with heat seal channels and quick dry construction. Cushions snaps easily to the seat.



Cushions

Mounting Plate



Mold #	#1	#2	#3	#4	#13	#16
1 Pack	Newport	Commodore	Yachtsman II	Seafarer	Bluewater	Admiral
Seat Shell Only:	1060002-S	1060206-S	1060410-S	1060610-S	1061205-S	1061405-S
Seat Shell w/ Cushion & Mounting Plate:	-	1060204-C	1060407-C	1060605-C	1061201-C	-
Seat Shell w/ Mounting Plate:	1060004	1060204	1060407	1060605	1061201	1061403
10 Pack OEM:	1060002-M	1060206-M	1060410-S	1060610-M	1061205-M	1061405-M
White Cushions:	1045014	1045020	1045028	1045014	1045035	1045036
Dimensions:	18"Hx20"Wx16"D	19"Hx20"Wx16"D	17"Hx21.5"Wx16"D	17"Hx16"Wx14"D	19.5"Hx25"Wx17"D	17"Hx19"Wx16"D

Seating Systems

Molded Seats

NEWPORT PACKAGE



Image	Part Number	Description	Pack Quantity
A.	1060100	Newport Adjustable Package	1 Pack

Package Includes:

- Newport molded seat with off white cushions
- 2-3/8" locking Trac-Lock™ swivel, rotates 360°
- Manual adjustable pedestal with 9" floor base, satin finish

Dimensions are from deck to top of swivel, and may vary slightly.



Rated ABYC Class H-31 AD

COMMODORE PACKAGE



Adjustable



Fixed Height

Image	Part Number	Description	Pack Quantity
A.	1000202	Commodore Adjustable Package	1 Pack
B.	1000205-L	Commodore Fixed Height Package	1 Pack

A. Package Includes:

- Commodore molded seat with off white cushions
- 2-3/8" locking Trac-Lock™ swivel, rotates 360°
- Manual adjustable pedestal with 9" floor base, satin finish

B. Package Includes:

- Commodore molded seat with off white cushions
- 2-7/8" locking Trac-Lock™ slide & swivel, rotates 360°
- Slide travels 5-1/4" fore and aft
- 15" fixed height pedestal with 9" round floor base, anodized finish

Dimensions are from deck to top of swivel, and may vary slightly.



Rated ABYC Class H-31 AD

YACHTSMAN PACKAGE



A.



B.

Image	Part Number	Description	Pack Quantity
A.	1001414-L	Yachtsman Fixed Height Package	1 Pack
B.	1001414	Deluxe Yachtsman Package	1 Pack

A. Package Includes:

- Yachtsman molded seat with off white cushions
- 2-7/8" locking Trac-Lock™ slide & swivel, rotates 360°
- Slide travels 5-1/4" fore and aft
- 15" fixed height pedestal with 9" round floor base, anodized finish

B. Package Includes:

- Yachtsman molded seat with off white cushions
- 2-7/8" locking Trac-Lock™ swivel, rotates 360°
- 15" fixed height pedestal with 9" round floor base, anodized finish

Dimensions are from deck to top of swivel, and may vary slightly.



Rated ABYC Class H-31 AD

SEAFARER PACKAGE



Image	Part Number	Description	Pack Quantity
A.	1000605-L	Seafarer Fixed Height Package	1 Pack

A. Package Includes:

- Seafarer molded seat with off white cushions
- 2-7/8" locking Trac-Lock™ swivel, rotates 360°
- 15" fixed height pedestal with 9" round base, anodized finish

One of our smallest molded seats! Cushions are made with plush foam padding covered in marine grade vinyl and snap easily onto seat.

Dimensions are from deck to top of swivel, and may vary slightly.



Rated ABYC Class H-31 AD

Molded Seats

BLUEWATER PACKAGE



Image	Part Number	Description	Pack Quantity
A.	1001204-L	Bluewater Adjustable Package	1 Pack

A. Package Includes:

- Bluewater molded seat with off white cushions
- 2-3/8" locking Track-Lock™ air-ride slide & swivel, rotates 360°
- Slide travels 5-1/4" fore and aft
- Air-powered adjustable mainstay with 9" round base, anodized finish

One of our largest molded seats! Cushions are made with plush foam padding covered in marine grade vinyl and snap easily onto seat. Designed for the plus size body frame

Dimensions are from deck to top of swivel, and may vary slightly.



Rated ABYC Class H-31 AD

ADMIRAL PACKAGE



Image	Part Number	Description	Pack Quantity
A.	1001408-L	Admiral Fixed Height Package	1 Pack

A. Package Includes:

- Admiral molded seat (cushions sold separately)
- 2-7/8" locking Trac-Lock™ swivel, rotates 360°
- 15" fixed height pedestal with 9" round base, anodized finish

Dimensions are from deck to top of swivel, and may vary slightly.



Rated ABYC Class H-31 AD

Seating Systems

Upholstered Seats

FLIP BACK SEAT

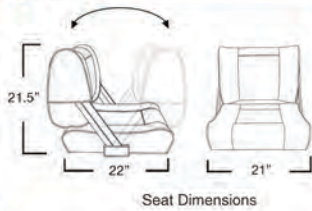
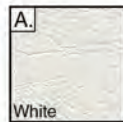

Image	Part Number	Description	Pack Quantity
A.	1042046	Flip Back Seat - White w/ Slide Bench Mount	1 Pack
B.	1042047	Flip Back Seat - White w/o Slide	1 Pack

Conveniently flips in either direction for your boating needs. Can use two seats for side by side seating. Constructed with heavy-duty marine grade vinyl over plush foam padding.

- Back moves fore and aft
- Off white upholstery
- Weather resistant marine grade vinyl
- Universal mounting pattern: 5" x 12"



Back View

BENCH DOUBLE BUCKET

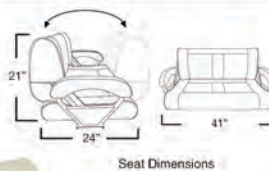
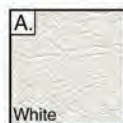

Image	Part Number	Description	Pack Quantity
A.	1042050	Double Bucket Seat	1 Pack

Bench seating for two. Unique flip back feature allows for fore and aft seating. Thick foam padding covered in marine grade vinyl over a high-strength composite substrate. Works with pedestal or box style mounting.

- Provides 35.5" of seating area
- Back moves fore and aft
- Off white upholstery
- Use with seat mount 3100545-W (sold separately)



Back View

TWIN 46 FLIP-UP SEAT

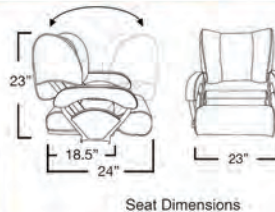
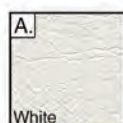

Image	Part Number	Description	Pack Quantity
A.	1043001	Twin 46 Flip-Up Seat	1 Pack

Lots of versatility with this seat. A comfortable seat or flip-up bolster for leaning and standing position, or flip the chair back for the fore and aft position. Foam padding covered with weather resistant marine grade vinyl.

- Flip-up bolster
- Back moves fore and aft
- Off white upholstery
- Universal mounting pattern: 5" x 12"



Lean Position

DELUXE SPORT FLIP-UP

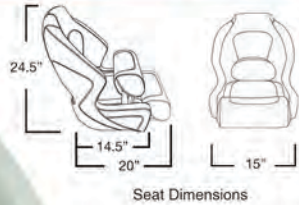
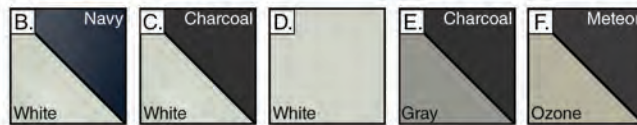

Image	Part Number	Description	Pack Quantity
A.	1043250-SFB	Deluxe Sport Flip-Up Seat - Sub, Foam, & Bolster Only	2 Pack
B.	1043251	Deluxe Sport Flip-Up Seat - Navy & White	1 Pack
C.	1043253	Deluxe Sport Flip-Up Seat - Charcoal & White	1 Pack
D.	1043259	Deluxe Sport Flip-Up Seat - White	1 Pack
E.	1043263	Deluxe Sport Flip-Up Seat - Charcoal & Gray	1 Pack
F.	1043295	Deluxe Sport Flip-Up Seat - Ozone White & Meteor Gray	1 Pack

Comfort and support seat, flip-up bolster for standing or leaning positions. Blow molded frame, with molded foam. Premium high quality upholstery with marine grade vinyl.

- Flip-up bolster
- Light weight blow molded frame
- Weather resistant marine grade vinyl
- Universal mounting pattern: 5" x 12"



A. Substrate & Foam

DELUXE SPORT BUCKET

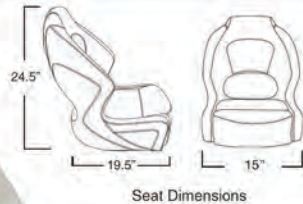
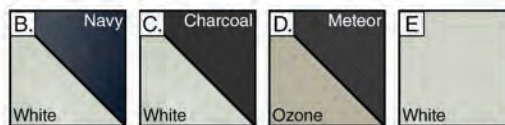

Image	Part Number	Description	Pack Quantity
A.	1043250-SF	Deluxe Sport Seat - Substrate & Foam Only	1 Pack
B.	1043691	Deluxe Sport Seat - Navy & White	1 Pack
C.	1043693	Deluxe Sport Seat - Charcoal & White	1 Pack
D.	1043695	Deluxe Sport Seat - Ozone White & Meteor Gray	1 Pack
E.	1043699	Deluxe Sport Seat - White	1 Pack

Premium upholstery and cushions are designed to provide maximum comfort and quality. Durable blow molded frame with ergonomically molded cushions and extended sides for extra support.

- Folds down easily
- Weather resistant marine grade vinyl
- Universal mounting pattern: 5" x 12"



A. Substrate & Foam

BUCKET SEAT

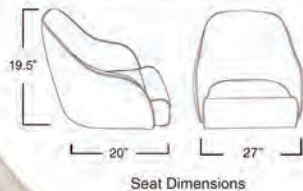
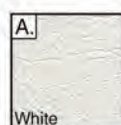

Image	Part Number	Description	Pack Quantity
A.	1040407	Bucket Seat - White	1 Pack

Spacious and attractive, Roto molded high-strength composite shell with high density foam padding covered by heavy-duty marine grade vinyl. This seat is made to last.

- Rotational molded composite shell
- Weather resistant marine grade vinyl
- Optimal UV protection
- Universal mounting pattern: 5" x 12"



Side View

Seating Systems

Upholstered Seats

COBRA FLIP-UP

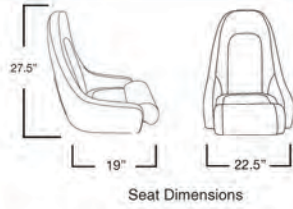
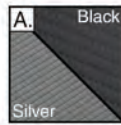

Image	Part Number	Description	Pack Quantity
A.	1040732	Cobra, Sport Flip-Up Seat - Silver & Black	1 Pack

Premium high quality upholstery and cushions with rigid injection molded frame for maximum support and comfort. Flip-up bolster for standing or leaning positions.

- Flip-up bolster
- Large mesh pocket on back of seat
- Weather resistant marine grade vinyl



Mesh Pocket on Back

OZARK BASS SEATS



Image	Part Number	Description	Pack Quantity
A.	1003224	Ozark, 3-Piece Bench - Charcoal & Meteor Gray	1 Pack
B.	1043224	Ozark, Bass Seat - Charcoal & Gray	1 Pack
C.	1043224-SF	Ozark, Bass Seat - Substrate & Foam Only	2 Pack
D.	1043200-SFB	Ozark, Bass Flip-Up - Substrate, Foam, & Bolster Only	2 Pack
E.	1043224-B	Ozark, Bass Flip-Up Seat - Charcoal & Gray	1 Pack
F.	1043224-CS	Ozark, Center Folding Seat - Charcoal & Gray	1 Pack
G.	1040224	Ozark, Casting Seat - Charcoal & Gray	1 Pack
H.	1049624	Ozark, Folding Seat - Charcoal & Gray	1 Pack

The Ozark Bass seat is available in a variety of options and styles, with premium high quality upholstery and cushions and a rigid injection molded frame for maximum support and comfort.

- Premium Upholstery
- Weather resistant marine grade vinyl
- Universal mounting pattern: 5" x 5" & 5" x 12"

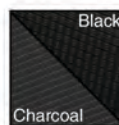
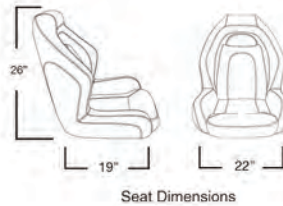

SPORT BUCKET SEAT

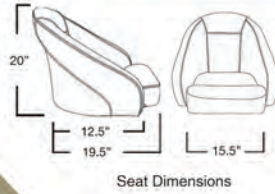
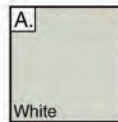

Image	Part Number	Description	Pack Quantity
A.	1043501	Sport Bucket Flip-Up Seat - White	1 Pack

Comfort and smooth riding on this seat. Plush foam padding covered in marine grade vinyl. Flip-up bolster converts easily from sit down to stand up leaning support. Rugged aluminum tubing bent and welded with molded foam.

- Flip-up bolster
- Heavy-duty aluminum frame
- Weather resistant marine grade vinyl
- Universal mounting pattern: 5" x 12"



ROYAL FLIP-UP SEAT

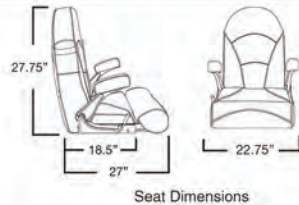
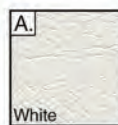

Image	Part Number	Description	Pack Quantity
A.	1040800	Royal Flip-Up Seat - White	1 Pack

Comfortable full size helm or captain's seat when flipped down. Flip-up the bolster for standing or leaning position. Armrest also flip-up and out of the way. Heavy-duty marine grade vinyl over plush foam padding.

- Flip-up bolster
- Large dry pocket on back of seat
- Weather resistant marine grade vinyl
- Use with short Cam-Lock, PN: 3100932 (sold separately)
- Mounting pattern: 5.25" x 9"



OCEAN FLIP-UP SEAT

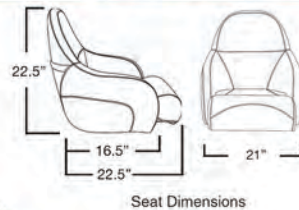
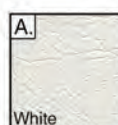

Image	Part Number	Description	Pack Quantity
A.	1040900	Ocean Flip-Up Seat - White	1 Pack

Comfortable runabout seat or flip-up the bolster for standing or leaning position. Roto molded high-strength composite shell with high density foam padding covered in marine grade vinyl.

- Flip-up bolster
- Large dry pocket on back of seat
- Weather resistant marine grade vinyl
- Universal mounting pattern: 5" x 12"



Seating Systems

Upholstered Seats

THIGH RISE FLIP-UP

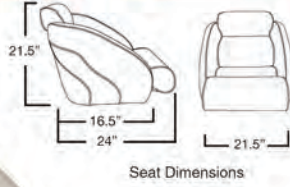
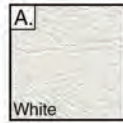

Image	Part Number	Description	Pack Quantity
A.	1042505	Thigh Rise Flip-Up Seat - White	1 Pack

Comfortable runabout seat or flip-up the bolster for standing or leaning position. Roto molded high-strength composite shell with high density foam padding covered in marine grade vinyl.

- Flip-up bolster
- Rotational molded composite shell
- Weather resistant marine grade vinyl
- Universal mounting pattern: 5" x 12"



Lean Position

DELUXE UPHOLSTERED

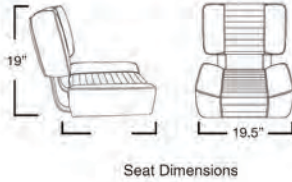

Image	Part Number	Description	Pack Quantity
A.	1040809	Deluxe Upholstered Seat - White	1 Pack
B.	1040002	Deluxe Captain's Seat - Seat w/ Armrests Only	1 Pack

Perfect for comfortably riding out rough conditions. High density foam cushions covered in marine grade vinyl for maximum comfort and durability.

- Anodized aluminum back support bars.
- (B.) Armrest supports and cushions
- Plastic durable substrate
- Optional armrests: 1041007 (sold separately)
- Universal mounting pattern: 5" x 5" and 5" x 12"



Side View



DELUXE CHAIR STANDS



Image	Part Number	Description	Pack Quantity
A.	1020003	Deluxe Captain's Chair Package	1 Pack
B.	1020004	Deluxe Captain's Chair Package With Gimbal	1 Pack
C.	1080018	Deluxe Captain's Chair Stand With Swivel	1 Pack

Seat rotates 360°. Chair stand has 1" anodized legs with rubber tip guards. Legs are 24.5" apart to provide a stable ride. (B. & C.) 28-3/8" from floor to top of seat cushion.

- Anodized aluminum arms and back support bars.
- Plastic durable substrate
- Bolt-on Gimbal



Deluxe Chair Package with Gimbal



Deluxe Chair Stand with Swivel

LADDER BACK SEATS



Image	Part Number	Description	Pack Quantity
A.	1061301	Ladder Back Seat - w/ White Cushions	1 Pack
B.	1061302	Ladder Back Seat - w/ White Cushions & Gimbal	1 Pack
C.	1061311	Ladder Back Seat - w/o Cushions	1 Pack
D.	1001311-NA	Ladder Back Seat - w/o Cushions & Armrests	1 Pack

2 piece plastic injection seat cover with a UV-stabilized polypropylene substrate for durability. Molded armrests with polished aluminum brackets.

- Molded grab handle on back of seat
- Removable snap on cushions
- Universal mounting pattern: 5" x 12"

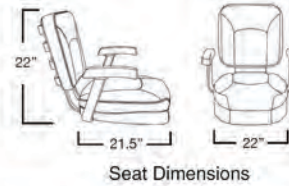

Upholstered Seats

LADDER BACK CHAIR PACKAGES



Image	Part Number	Description	Pack Quantity
A.	1001303	Ladder Back Chair Package	1 Pack
B.	1001304	Ladder Back Chair Package w/ Gimbal	1 Pack

A. Package Includes:

- 2 piece plastic injection seat with armrests and white cushions
- 2-7/8" Trac-Lock™ slide/swivel (locking) rotates 360° & travels 5-1/4" fore and aft
- 18" fixed height pedestal with 9" round base, anodized finish

B. Package Includes:

- 2 piece plastic injection seat with armrests, gimbal, and white cushions
- 2-7/8" Trac-Lock™ slide/swivel (locking) rotates 360° & travels 5-1/4" fore and aft
- 18" fixed height pedestal with 9" round base, anodized finish



Rated ABYC
Class H-31 AD

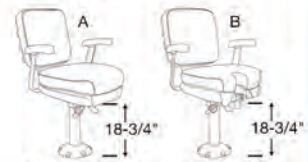

Dimensions are from top of deck to top of slide & swivel and may vary slightly

BAR STOOL PACKAGES



Stainless Steel

Aluminum

Image	Part Number	Description	Pack Quantity
A.	1081224-G	24" Stainless Steel Bar Stool Package	1 Pack
B.	1081224-GAL	24" Aluminum Bar Stool Package	1 Pack
A.	1081230-G	30" Stainless Steel Bar Stool Package	1 Pack
B.	1081230-GAL	30" Aluminum Bar Stool Package	1 Pack
C.	1081233	Bar Stool Seat - Gray	1 Pack

Durable 15" round bar stool seat with thick plush cushion provides support and comfort. 2-7/8" pedestal, available in 316 mirror finish stainless steel or high strength aluminum.

- Stainless steel arched back support
- Chrome Trac-Lock™ swivel
- 14" Round stainless steel or aluminum footrest

Rated ABYC
Class H-31 AP



15" Round
Bar Stool Seat

Seating Systems

Upholstered Seats

LEANING POST



Image	Part Number	Description	Pack Quantity
A.	1045070	Seat Cushion Only - White	1 Pack
B.	1080080	Leaning Post - With Seat Cushion	1 Pack
C.	1080080-NC	Leaning Post - Frame Only	1 Pack
D.	1080085	Backrest With Cushion	1 Pack
E.	1080088	Rod Holders	1 Pack

High-strength aluminum bent and welded frame. Thick foam padding covered with marine grade vinyl. Leaning post packed in a box the size of cushion for shipping and storage.

- Easy assembly and installation
- Optional rod holders and back support
- Mounting hardware included

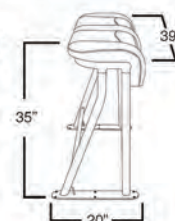

COOLER SEAT



Image	Part Number	Description	Pack Quantity
A.	1042010	Cooler Flip Back Seat - White	1 Pack
B.	1042010-SF	Cooler Flip Back Seat - No Upholstery	1 Pack

Back rest conveniently flips in either direction. Thick foam padding covered in marine grade vinyl. Seat/Lid opens up to cooler keeping your drinks and food fresh all day.

- 72 quarts
- Aluminum rails with stainless steel hardware
- Dimensions: 37" H x 32" W x 18-1/2" D
- Seating height: 20-1/2" H



DOCK BENCH



Image	Part Number	Description	Pack Quantity
A.	1099050-2	Aluminum Dock Bench	1 Pack
B.	1099050-2A	Aluminum Dock Bench - With Armrests	1 Pack

Strong anodized aluminum frame with extruded aluminum support legs.

- Easy to assemble
- Heavy duty design
- Weather resistant for harsh marine environment
- Packs neatly into box (19" W x 42" L x 5" D)





VINYL & FABRIC FAMILY GROUPS

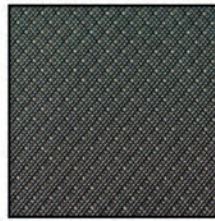

LEGACY - 197

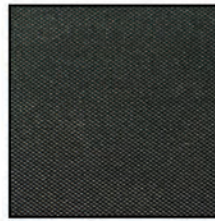

SEDONA - 102



HERITAGE - 290



IMPERIAL - 215



GRANDEUR
219



BELLWETHER
041



SORRENTO
007



SORRENTO
PEARL - 007



COACHMAN
447



COACHMAN LX
122



OPULENCE
186

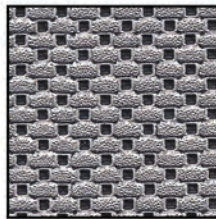

REGAL - 160

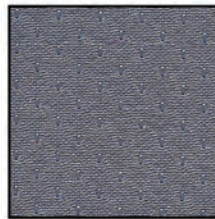

ORNATE - 189

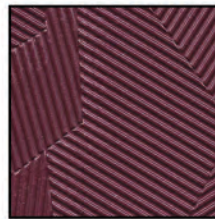

MOSAIC - 261



CLASSIC WEAVE
263



RATTAN - 264

Vinyl Collection



SPRINGFIELD MARINE'S
VINYL & FABRIC COLLECTION

AVAILABLE IN A VARIETY OF COLORS AND STYLES

Seating Systems

Helm Seats

MARINER HELM

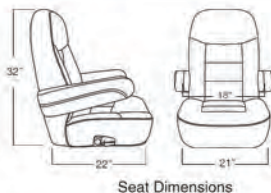

Seat Dimensions

Image	Part Number	Description	Pack Quantity
A.	1042080-B	Mariner Helm Chair - Black	1 Pack
B.	1042080-W	Mariner Helm Chair - White	1 Pack
C.	1042081-BC	Mariner Helm Chair - Black/Charcoal	1 Pack

Luxury helm seat with plush foam padding covered in marine grade vinyl and heavy-duty powder coated steel frame.

- Back reclines 45 degrees
- Armrests flip up - out of the way
- Universal mounting pattern: 5" x 12"

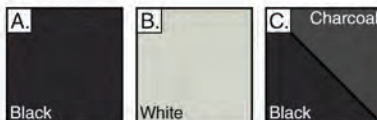

WHEELHOUSE HELM



(A.) Seat Dimensions

Image	Part Number	Description	Pack Quantity
A.	1042120-XLB	Wheelhouse XL Helm Seat - Black	1 Pack

Wheelhouse Helm seat offers a heavy-duty powder coated steel shock absorbing suspension seat frame with 9" thick foam cushions covered in marine grade vinyl.

- Back reclines 45 degrees
- Armrests flip up - out of the way
- Universal mounting pattern: 5" x 12"



CHARTSMAN 2 HELM

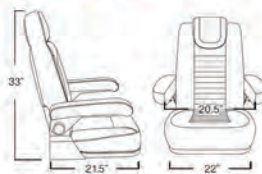

Seat Dimensions

Image	Part Number	Description	Pack Quantity
A.	1042030-B2	Chartsman 2 Helm Seat - Black	1 Pack

Chartsman 2 Helm seat has plush foam padding covered in quality marine grade vinyl. Durable aluminum frame. Headrest extends for maximum comfort.

- Back reclines 45 degrees
- Armrests flip up - out of the way
- Polished stainless steel armrest adjuster
- Universal mounting pattern: 5" x 12"



HELMSMAN HELM

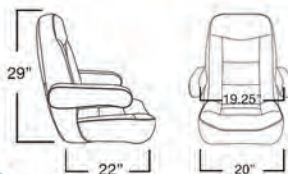

Seat Dimensions

Image	Part Number	Description	Pack Quantity
A.	1042110-B	Helmsman Reclining Pilot Seat - Black	1 Pack

Helmsman Pilot seat offers a heavy-duty powder coated steel shock absorbing suspension seat frame. 6" thick foam cushions covered in marine grade vinyl.

- Back reclines 45 degrees
- Armrests flip up - out of the way
- Designed for 5" x 12" slide - no mounting plate required



NORWEGIAN HELM

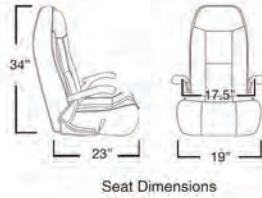
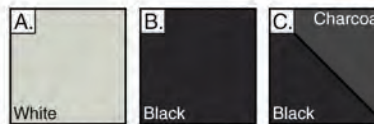

Image	Part Number	Description	Pack Quantity
A.	1042064	Norwegian Helm Seat - White	1 Pack
B.	1042066	Norwegian Helm Seat - Black	1 Pack
C.	1042093	Norwegian Helm Seat - Black / Charcoal	1 Pack

Luxury Helm seat provides maximum comfort for long rides. Plush foam padding covered with heavy-duty marine grade vinyl. Light weight aluminum frame.

- Back reclines 45 degrees
- Armrests flip-up - out of the way
- Weather resistant marine grade vinyl
- Universal mounting pattern: 5" x 12"



DIAMONDBACK RECLINE

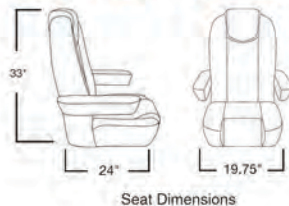
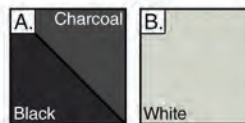

Image	Part Number	Description	Pack Quantity
A.	1042224	Diamondback Recline Seat - Black / Charcoal	1 Pack
B.	1042294	Diamondback Recline Seat - White	1 Pack

Designed for style and durability. Large high back, reclines for maximum comfort. Plush foam padding covered with heavy-duty marine grade vinyl. Light weight aluminum frame.

- Armrests flip-up - out of the way
- Weather resistant marine grade vinyl
- Universal mounting pattern 5" x 12"



ALUMINUM FRAME



Image	Part Number	Description	Pack Quantity
A.	1042140-F	Aluminum High Back - Frame Only	1 Pack
B.	1042140-FA	Aluminum High Back - Frame & Armrests	1 Pack
C.	1041242-C	Aluminum High Back - Upholstered Helm Seat	1 Pack

Image	Part Number	Description	Pack Quantity
A.	1042150-F	Aluminum Low Back - Frame Only	1 Pack
B.	1042150-FA	Aluminum Low Back - Frame & Armrests	1 Pack
C.	1042150-PR	Aluminum Low Back - Armrests (Pair)	1 Pack
D.	1042159	Aluminum Low Back - Bolster Plate	1 Pack

Aluminum Frame Helm seat, available as high back or low back.

- Light weight aluminum construction
- Removable armrests (sold separately)
- Reclines back easily

Seating Systems

Helm Seats

NORWEGIAN PACKAGE

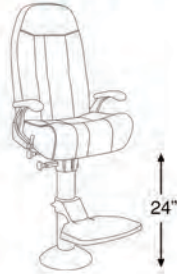

Image	Part Number	Description	Pack Quantity
A.	1002062	Fixed Height Norwegian Helm Package	1 Pack

Package Includes:

Norwegian helm seat, heavy-duty 4" Workhorse slide & swivel 24" fixed height brite dip pedestal with 12" round floor base, Helmsman flip-up footrest.



HELMSMAN PACKAGE



Image	Part Number	Description	Pack Quantity
A.	1002110	Adjustable Helmsman Helm Package	1 Pack

Package Includes:

Helmsman pilot helm seat, heavy-duty 4" air-ride Mariner II slide & swivel, 4" brite dip pedestal with 12" round floor base, adjusts from 18" to 28". Seat mounting footrest offers adjustable height and flips-up out of the way.



MARINER PACKAGE



Image	Part Number	Description	Pack Quantity
A.	1002083	Adjustable Mariner Helm Package	1 Pack

Package Includes:

Mariner helm seat, heavy-duty 4" air-ride Mariner II slide & swivel, 4" brite dip pedestal with 12" round floor base, adjusts from 18" to 28". Seat mounting footrest offers adjustable height and flips-up out of the way.



OFFSHORE 2-7/8" PACKAGE



Pedestal Adjusts 25-1/4" to 32-3/4"

Overall Height 26-1/2" to 34"

Part Number	Description	Pack Quantity
1252140	Adjustable Heavy-Duty Mainstay Helm Package	1 Pack

Package Includes:

2-7/8" locking air-ride Prestige slide & swivel, Mainstay pedestal with 3.5" outer post and 2-7/8" inner post, 12" round floor base with anodized finish. Helmsman flip-up footrest and 3.5" bushing.

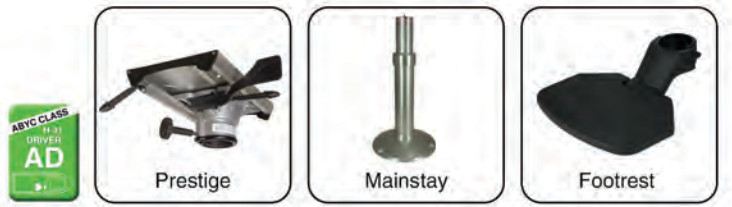

OFFSHORE 4" PACKAGE



24" Fixed Height Pedestal.

Overall Height 27-1/2"

Part Number	Description	Pack Quantity
1457545	4" Fixed Height Helm Pedestal Package	1 Pack

Heavy-duty 4" Workhorse slide & swivel, anodized finish. 4" fixed height brite dip pedestal with 12" round floor base. Helmsman flip-up footrest, flips-up out of the way.

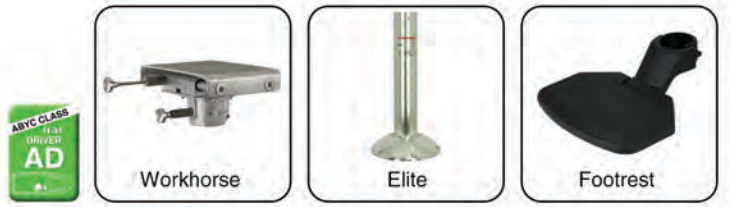

OFFSHORE 4" ADJUSTABLE



Pedestal Adjusts 18" to 26"

Overall Height 22" to 30"

Part Number	Description	Pack Quantity
1276548	4" Air-Ride Helm Pedestal Package	1 Pack

Heavy-duty 4" air-ride Mariner II slide & swivel, anodized finish. 4" brite dip pedestal with 12" round polished floor base. Seat mounting footrest offers adjustable height and flips-up out of the way.



Seating Systems

Helm Seats

INSHORE LE1 PACKAGE



Pedestal Adjusts
13-1/2" to 19"

Overall Height
20" to 27"

Part Number	Description	Pack Quantity
1255595-NC	Inshore LE1 Pedestal Package	1 Pack

Heavy-duty adjustable Mainstay package, adjusts from 13-1/2" to 19". Includes locking Trac-Lock™ air-ride slide & swivel. Half-round stainless steel footrest, 316 electro polished stainless steel. Black powder coated 5 legged deck base.



INSHORE RS2 PACKAGE



18" Fixed Height
Pedestal

Overall Height
25-1/2"

Part Number	Description	Pack Quantity
1455580-NC	Inshore RS2 Pedestal Package	1 Pack

Locking Workhorse swivel mount, anodized finish. 4" fixed height pedestal with 12" round floor base and high-strength polished aluminum finish. 316 electro polished stainless steel 28" round footrest. Black powder coated 5 legged deck base.



INSHORE LX2 PACKAGE



Pedestal Adjusts
13-1/2" to 18"

Overall Height
23" to 27-1/2"

Part Number	Description	Pack Quantity
1275580-NC	Inshore LX2 Pedestal Package	1 Pack

Air-ride locking Workhorse swivel mount, anodized finish. 4" pedestal with 12" round floor base, and high-strength polished aluminum finish. 28" round footrest, 316 electro polished stainless steel. Black powder coated 5 legged deck base.



Passenger Vessel Seating

The Passenger Vessel assortment has been developed in partnership with Modell Møbler Marine Seating, an international innovator in the field of marine furniture. With focus on leisure craft and passenger ferries, quality designs ensure that passengers enjoy a pleasant trip with a high degree of comfort.

From cabin seating and comfort seating, all the way to crew seating, Springfield Marine has it all! Including top of the line, easy to customize passenger accessories for all your seating applications.

Passenger & Commercial catalogs now available

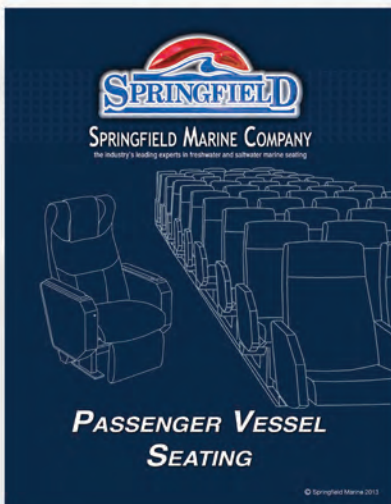

Senja High - Recline



Bahama Turn Up



Officially Licensed By

MODELL MØBLER
 marine seating

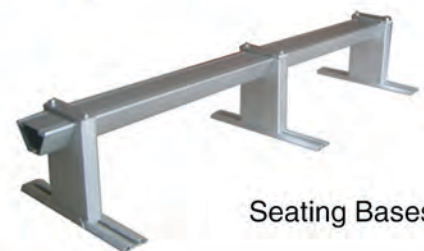

Seating Bases

KingPin™ Series

ABOUT KINGPIN™

Springfield Marine's first generation removable pedestal, the KingPin™ is still the most popular seating system among freshwater boaters. The centerpiece of the KingPin™ system is the Hi-Lo pedestal. In the Hi position, the pedestal is a comfortable fishing seat. Remove the post and insert the seat mount into the base for the Lo position - ideal for compact storage to provide maximum visibility for the driver while the boat is underway.

It's simple... a 3/4" E-Coated steel pin extends from the bottom of the pedestal as well as from the bottom of the seat mount. And each pin fits into the socket of the KingPin™ deck base.

Springfield Marine offers the KingPin™ system in a choice of two styles... Standard and Threaded. The Standard pin, with its high-strength composite clip, is designed to prevent unintentional detachment. Threaded has a threaded pin at the bottom of the post which can simply and easily be threaded into the base. Both systems provide an effective, safe, and secure boating experience, that meet the ABYC H-31 standard for fishing positions.

Posts have been updated to Anodized for corrosion resistance and visual appeal.

System meets ABYC H-31 B Rating.

PACKAGES • SEAT MOUNTS • PEDESTALS • BASES • ACCESSORIES



Standard



Threaded

Products in the KingPin™ series are
DESIGNED FOR RECREATIONAL USE ONLY

Hi-Lo 3-Piece Package

Retail					
Image	Part Number	Description	Unit Height	Pack Quantity	ABYC
A.	1615431-1	Standard Hi-Lo 3-Piece Package	13-1/2"	1 Retail	B
A.	1615433-1	Standard Hi-Lo 3-Piece Package	15-1/2"	1 Retail	B
B.	1630401-1	Threaded Hi-Lo 3-Piece Package	13-1/2"	1 Retail	B

Retail packed in box with 4 color label

Hi-Lo 3-Piece set (A.) includes the following parts:

- Standard KingPin™ 11" or 13" post (#1610411-A or 1610413-A)
- KingPin™ Hi-Lo swivel, e-coat finish (#1615201-EC)
- Standard KingPin™ 7" x 7" base, stainless steel with satin finish (#1620001)

Hi-Lo 3-Piece set (B.) includes the following parts:

- Threaded KingPin™ 11" post (#1630411-A)
- KingPin™ Hi-Lo swivel, e-coat finish (#1615201-EC)
- Threaded KingPin™ 7" x 7" base, stainless steel with satin finish (#1630001)

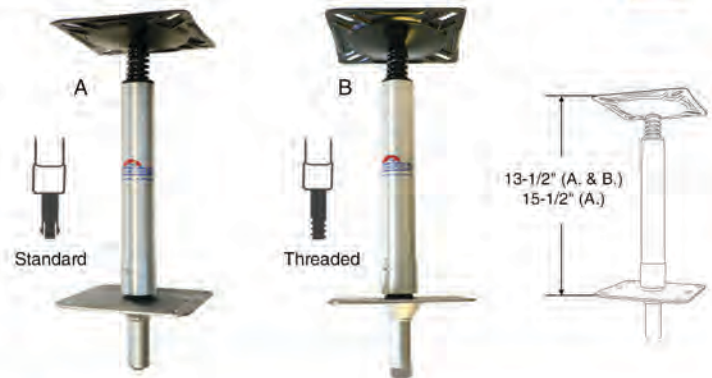

KingPin™ Sets Are Rated ABYC Class H-31 B



KingPin™

Power-Rise Stand-Up Posts

Retail						
Image	Part Number	Pin	Adjusts	Finish	Pack Quantity	ABYC
A.	1612402-A	Standard	23-1/2" to 30-1/2"	Anodized	1 Retail	B
B.	1632013-A	Threaded	23-1/2" to 30-1/2"	Anodized	1 Retail	B

OEM						
Image	Part Number	Pin	Adjusts	Finish	Pack Quantity	ABYC
A.	3612402-A	Standard	22-1/2" to 29-1/2"	Anodized	1 Bulk	B
B.	3632013-A	Threaded	22-1/2" to 29-1/2"	Anodized	2 Bulk	B
B.	3631013-PSS	Threaded	22-1/2" to 29-1/2"	Brite Dip	20 Bulk	B
B.	3632013-EC	Threaded	22-1/2" to 29-1/2"	E-Coat	20 Bulk	B

Retail packages are packed in clamshell with 4 color label

Power-Rise Stand-Up posts adjust from 22-1/2" to 29-1/2"
Use with standard or threaded KingPin™ base (sold separately).

Pedestals listed as PSS are brite dip (P) with stainless steel pin (SS)

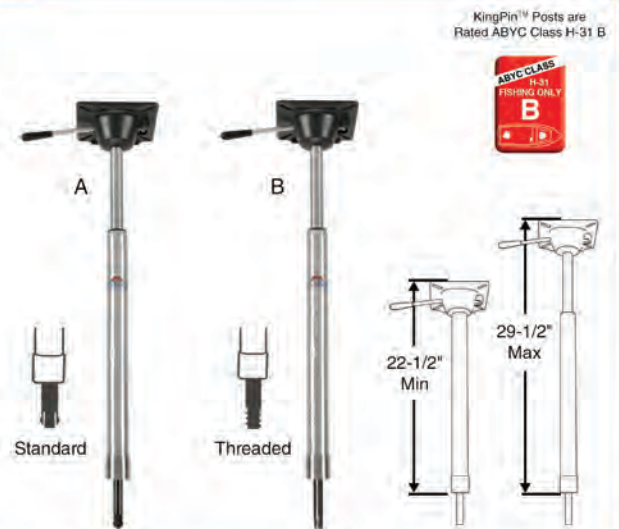

KingPin™ Posts are Rated ABYC Class H-31 B



Power-Rise Sit down Posts

Retail						
Image	Part Number	Pin	Adjusts	Finish	Pack Quantity	ABYC
A.	1612401-A	Standard	16" to 22-3/8"	Anodized	1 Retail	B
B.	1632012-A	Threaded	16" to 22-3/8"	Anodized	1 Retail	B

OEM						
Image	Part Number	Pin	Adjusts	Finish	Pack Quantity	ABYC
A.	3612401-A	Standard	16" to 22-3/8"	Anodized	1 Bulk	B
B.	3631012-PSS	Threaded	16" to 22-3/8"	Brite Dip	10 Bulk	B
B.	3632012-A	Threaded	16" to 22-3/8"	Anodized	2 Bulk	B

Retail packages are packed in clamshell with 4 color label

Power-Rise Stand-Up posts adjust from 16" to 22-3/8"
Use with standard or threaded KingPin™ base (sold separately).

Pedestals listed as PSS are brite dip (P) with stainless steel pin (SS)



KingPin™ Posts are Rated ABYC Class H-31 B



KingPin™ Series

KingPin™

Power-Rise Stand-Up Posts

Retail					
Image	Part Number	Description	Pin	Pack Quantity	ABYC
A.	1611433	Power-Rise Stand Up Package	Standard	1 Retail	B
B.	1631037	Power-Rise Stand Up Package	Threaded	1 Retail	B

Retail packed in box with 4 color label

Stand-Up package (A.) includes the following parts:

- Standard Power-Rise Stand-Up post (#1611431-A)
- Quik-Tilt seat mount (#1615254-EC)
- Gray Pro Stand-Up seat (#1040213)

Stand-Up package (B.) includes the following parts:

- Threaded Power-Rise Stand-Up post (#1633013-A)
- Quik-Tilt seat mount (#1615254-EC)
- Gray Pro Stand-Up seat (#1040213)

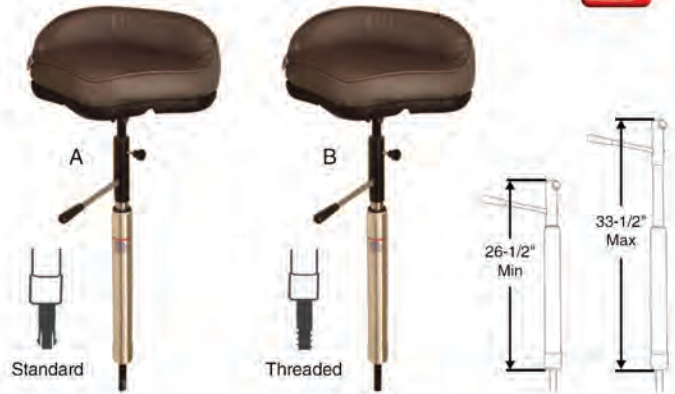

KingPin™ Posts are Rated ABYC Class H-31 B



Power-Rise Stand-Up Posts

Retail						
Image	Part Number	Description	Finish	Pin	Pack Quantity	ABYC
A.	3611431-A	Power-Rise Post Only	Anodized	Standard	1 Bulk	B

Retail packages are packed in box with 4 color label

OEM						
Image	Part Number	Description	Finish	Pin	Pack Quantity	ABYC
B.	3633011-SSA	Power-Rise Post Only	Anodized	Threaded	10 Bulk	B
B.	3633013-A	Power-Rise Post Only	Anodized	Threaded	10 Bulk	B
B.	3633013-SSA	Power-Rise Post Only	Anodized	Threaded	10 Bulk	B

Power-Rise Stand-Up posts adjust from 26-1/2" to 32-1/2" unless otherwise noted. Use with standard or threaded KingPin™ bases (sold separately). Easy stow for Rod Lockers.

Pedestals listed as SSA have a Stainless Steel Pin and Anodized post.

Sit Down Power-Rise Post: 3633011-SSA adjusts from 15-1/2" to 18-1/2"

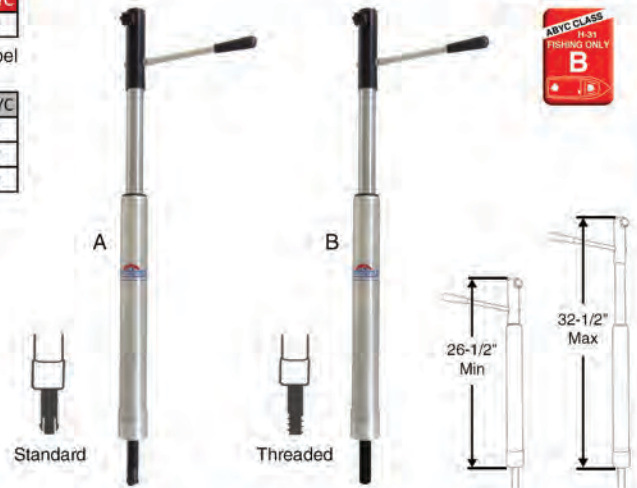

KingPin™ Posts are Rated ABYC Class H-31 B



Quik-Tilt Seat Mount

Retail					
Image	Part Number	Description	Finish	Pack Quantity	ABYC
A.	1615254-EC	Quik-Tilt Seat Mount	E-Coat	6 Retail	B

OEM					
Image	Part Number	Description	Finish	Pack Quantity	ABYC
A.	3615254-EC	Quik-Tilt Seat Mount	E-Coat	20 Bulk	B

Retail packages are packed in clamshell with 4 color label

Unintentional detachment to comply with ABYC. E-coat rust resistant finish swivel, rotates 360° 4 snap-in angles (0°, 30°, 60°, 90°) Use with any KingPin™ post (sold separately).



KingPin™ Seat Mounts are Rated ABYC Class H-31 B



7" x 7" Swivel Seat Mount

Retail					
Image	Part Number	Description	Finish	Pack Quantity	ABYC
A.	1614201-PP	Seat Mount With Spring	Polished	6 Retail	B
A.	1615201-EC	Seat Mount With Spring	E-Coat	6 Retail	B
B.	1615204-EC	Seat Mount No Spring	E-Coat	6 Retail	B
B					
OEM					
Image	Part Number	Description	Finish	Pack Quantity	ABYC
A.	3614201-PP	Seat Mount With Spring	Polished	20 Bulk	B
B.	3614204-PP	Seat Mount No Spring	Polished	20 Bulk	B
A.	3615201-EC	Seat Mount With Spring	E-Coat	20 Bulk	B
B.	3615204-EC	Seat Mount No Spring	E-Coat	20 Bulk	B

Retail packages are packed in clamshell with 4 color label

Unintentional detachment to comply with ABYC. E-coat or polished passivated rust resistant finish. Polished passivated swivels are stainless steel. Fits bolt pattern 4.5" x 5.5" square. Swivel rotates 360°. Seat mount has 3° tilt. Use with any KingPin™ post (sold separately).



KingPin™ Seat Mounts are Rated ABYC Class H-31 B



7" x 7" Hi-Rise Seat Mount

OEM					
Image	Part Number	Description	Pin	Pack Quantity	ABYC
A.	3615207-ECB	7" x 7" Hi-Rise Seat Mount	E-Coat	20 Bulk	B

Unintentional detachment to comply with ABYC. Aluminum cast powder coat finish, swivel rotates 360°. Use with any KingPin™ post (sold separately).

Swivel adds 2-11/16 to height of post. Seat mount has 3° tilt.



KingPin™ Seat Mounts are Rated ABYC Class H-31 B



Manual Adjustable Posts

Retail						
Image	Part Number	Pin	Adjusts	Finish	Pack Quantity	ABYC
A.	1613401-EC	Standard	22" to 31"	E-Coat	6 Retail	B
A.	1613402-A	Standard	22" to 31"	Anodized	6 Retail	B
B.	1630801-A	Threaded	22" to 31"	Anodized	6 Retail	B
B.	1630801-EC	Threaded	22" to 31"	E-Coat	6 Retail	B
OEM						
Image	Part Number	Pin	Adjusts	Finish	Pack Quantity	ABYC
A.	3613401-EC	Standard	22" to 31"	E-Coat	20 Bulk	B
B.	3613402-A	Standard	22" to 31"	Anodized	20 Bulk	B
B.	3630801-A	Threaded	22" to 31"	Anodized	20 Bulk	B
B.	3630801-EC	Threaded	22" to 31"	E-Coat	20 Bulk	B

Retail packages are packed in clamshell with 4 color label

Manually adjustable posts adjusts from 22" to 31" in 1" increments. Posi-Lock lever secures post at desired height. Available in anodized or e-coat finish. Use with any KingPin™ seat mount (sold separately).

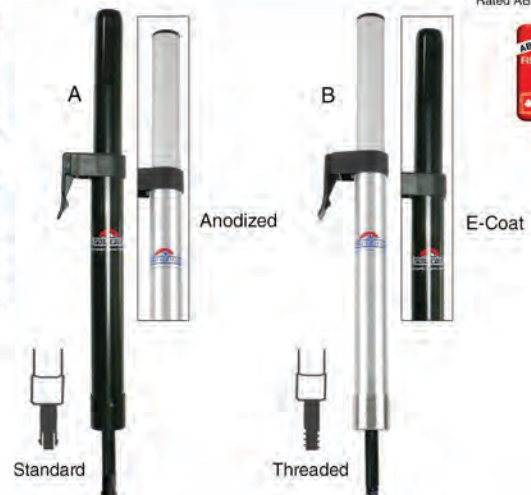

KingPin™ Posts are Rated ABYC Class H-31 B



KingPin™

KingPin™ Series

KingPin™

Standard Fixed Height Posts

Image	A.	B.	C.	Retail	
Height	Anodized	E-Coat	Brite Dip	Pack Quantity	ABYC
11"	1610411-A	1610411-EC	-	6 Retail	B
13"	1610413-A	1610413-EC	-	6 Retail	B
15"	1610415-A	-	-	6 Retail	B
25"	1610425-A	-	-	6 Retail	B

Image	A.	B.	C.	OEM	
Height	Anodized	E-Coat	Brite Dip	Pack Quantity	ABYC
11"	3610411-A	3610411-EC	3610411-P	20 Bulk	B
13"	3610413-A	3610413-EC	3610413-P	20 Bulk	B
15"	3610415-A	-	3610415-P	20 Bulk	B
25"	3610425-A	3610425-EC	3610425-P	20 Bulk	B

Retail packages are packed in clamshell with 4 color label

Hefty 1-3/4" diameter post and reinforcement ring.

Available in a variety of lengths and finishes.

Use with any KingPin™ seat mount (sold separately).

Use with any standard KingPin™ base (sold separately).



Threaded Fixed Height Posts

Image	A.	B.	C.	Retail	
Height	Anodized	E-Coat	Brite Dip	Pack Quantity	ABYC
11"	1630411-A	-	-	6 Retail	B
13"	1630402-A	1630402-EC	-	6 Retail	B
15"	1630423-A	-	-	6 Retail	B
25"	1630415-A	-	-	6 Retail	B

Image	A.	B.	C.	OEM	
Height	Anodized	E-Coat	Brite Dip	Pack Quantity	ABYC
11"	3630411-A	-	-	20 Bulk	B
13"	3630402-A	3630402-EC	3630402-P	20 Bulk	B
15"	3630423-A	-	3630423-P	20 Bulk	B
25"	3630414-A	3630414-EC	-	20 Bulk	B

Retail packages are packed in clamshell with 4 color label

Hefty 1-3/4" diameter post and reinforcement ring.

Available in a variety of lengths and finishes.

Use with any KingPin™ seat mount (sold separately).

Use with any threaded KingPin™ base (sold separately).



Fixed Height Posts With Stainless Steel Pins

Brite Dip Post With Stainless Steel Pin

Image	A.	B.	OEM	
Height	Standard	Threaded	Pack Quantity	ABYC
13"	3610413-PSS	3630402-PSS	20 Bulk	B

Stainless Steel Post & Pin

Image	C.		OEM	
Height	Standard	Threaded	Pack Quantity	ABYC
13"	-	3630413-SS	20 Bulk	B

(A. & B.) Hefty 1-3/4" diameter post and reinforcement ring.

(C.) 13" Stainless steel 1-3/4" diameter post with reinforcement ring and stainless steel threaded pin.

Use with any KingPin™ seat mount (sold separately).

Use with any standard or threaded KingPin™ base (sold separately).

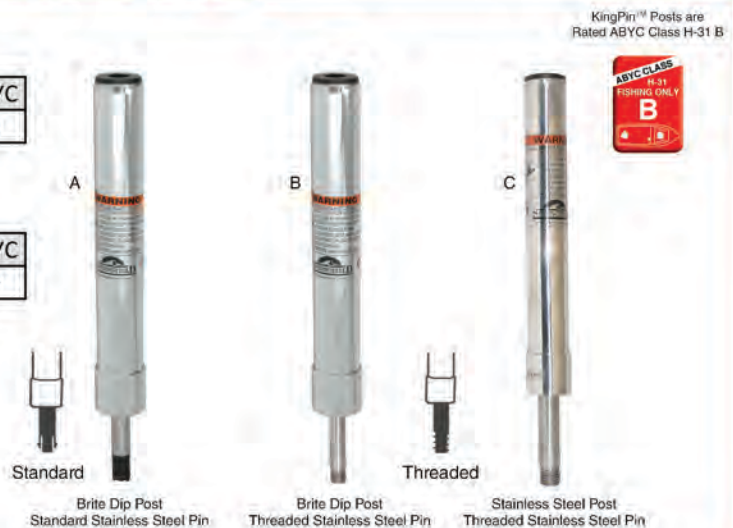

Salt Water Approved

Offset Posts

Retail						
Image	Part Number	Height	Pin	Pack Quantity	ABYC	
A.	1610413-OSS	13"	Standard	6 Retail	B	
B.	1630402-CSS	13"	Threaded	6 Retail	B	

OEM						
Image	Part Number	Height	Pin	Pack Quantity	ABYC	
A.	3610413-OSS	13"	Standard	20 Pack	B	
B.	3630402-CSS	13"	Threaded	20 Pack	B	

Retail packages are packed in clamshell with 4 color label

13" hefty 1-3/4" diameter stainless steel post with mild steel e-coat pin. Provides a full 5" of offset extension.

Use with any KingPin™ seat mount (sold separately).
Use with any standard or threaded KingPin™ base (sold separately).

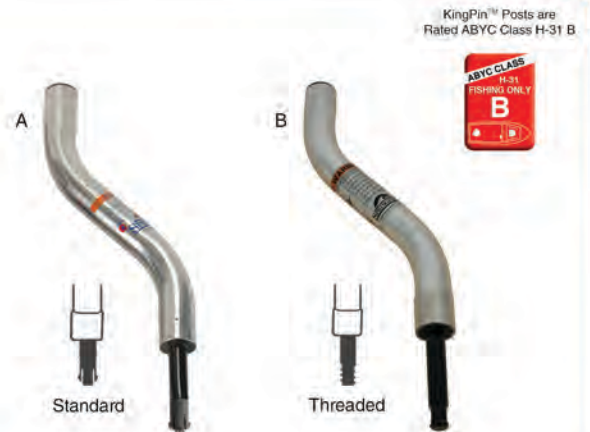

Standard Square Steel Bases

Retail							
Image	Part Number	Base Size	Material	Finish	Bushing	Pack Quantity	ABYC
A.	1620001	7" x 7"	Stainless Steel	Satin	Nylon	6 Retail	B
C.	1620003	7" x 7" Offset	Stainless Steel	Satin	Nylon	6 Retail	B

OEM							
Image	Part Number	Base Size	Material	Finish	Bushing	Pack Quantity	ABYC
A.	3620001	7" x 7"	Stainless Steel	Satin	Nylon	20 Pack	B
B.	3620001-P	7" x 7"	Stainless Steel	Polished	Nylon	20 Pack	B
C.	3620003	7" x 7" Offset	Stainless Steel	Satin	Nylon	20 Pack	B
D.	3620011	7" x 7"	Mild Steel	E-Coat	Nylon	20 Pack	B
E.	3620018	7" x 7"	Mild Steel	Black Krinkle	Nylon	20 Pack	B

Retail packages are packed in clamshell with 4 color label

Standard square bases, available in stainless steel or mild steel with a variety of finishes. 3" cup depth. Below the deck mount (requires a 2-1/2" hole in deck).

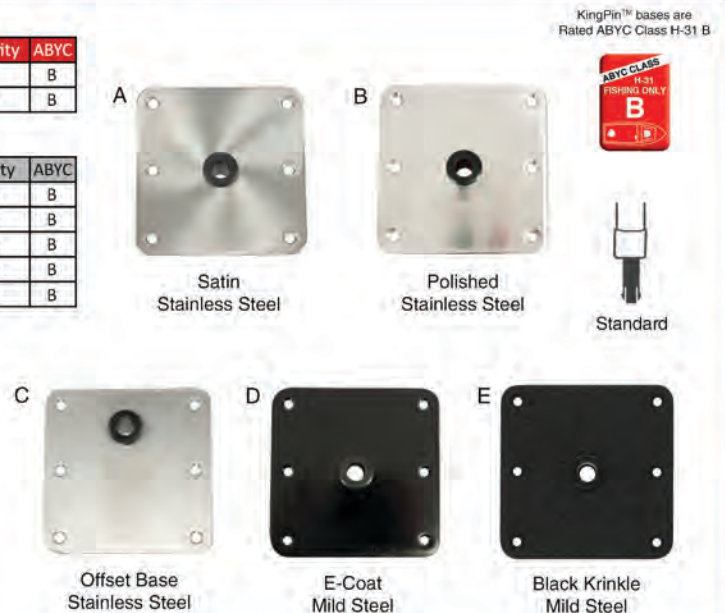
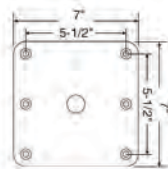

Standard Rectangular Steel Bases

Retail							
Image	Part Number	Base Size	Material	Finish	Bushing	Pack Quantity	ABYC
A.	1620004	6" x 8"	Stainless Steel	Satin	Nylon	6 Retail	B
B.	1620005	4" x 8"	Stainless Steel	Satin	Nylon	6 Retail	B

OEM							
Image	Part Number	Base Size	Material	Finish	Bushing	Pack Quantity	ABYC
A.	3620004	6" x 8"	Stainless Steel	Satin	Nylon	20 Pack	B
B.	3620005	4" x 8"	Stainless Steel	Satin	Nylon	20 Pack	B
C.	3620005-P	4" x 8"	Stainless Steel	Polished	Nylon	20 Pack	B

Retail packages are packed in clamshell with 4 color label

Standard rectangular bases, available in stainless steel or mild steel with a variety of finishes. 3" cup depth. Below the deck mount (requires a 2-1/2" hole in deck).

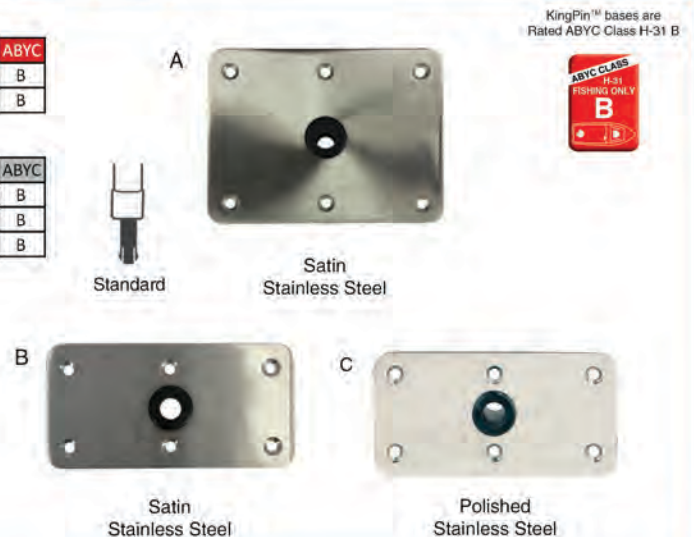

KingPin™ Series

Threaded Square Steel Bases

Retail

Image	Part Number	Base Size	Material	Finish	Bushing	Pack Quantity	ABYC
A.	1630001	7" x 7"	Stainless Steel	Satin	Nylon	6 Retail	B
B.	1630001-P	7" x 7"	Stainless Steel	Polished	Nylon	6 Retail	B
C.	1630003	7" x 7" Offset	Stainless Steel	Satin	Nylon	6 Retail	B

OEM

Image	Part Number	Base Size	Material	Finish	Bushing	Pack Quantity	ABYC
A.	3630001	7" x 7"	Stainless Steel	Satin	Nylon	20 Pack	B
C.	3630003	7" x 7" Offset	Stainless Steel	Satin	Nylon	1 Pack	B
D.	3630018	7" x 7"	Mild Steel	Black Krinkle	Nylon	20 Pack	B
E.	3630020	7" x 7"	Mild Steel	E-Coat	Nylon	20 Pack	B
F.	3630020-OS	7" x 7" Offset	Mild Steel	E-Coat	Nylon	20 Pack	B

Retail packages are packed in clamshell with 4 color label

Threaded square bases, available in polished or satin stainless steel, and mild steel with e-coat finish. 4" cup depth for use with threaded KingPin™ posts (sold separately). Below the deck mount (requires a 3-3/4" hole in deck).



Welded 3/4 x 10 stainless steel nut.

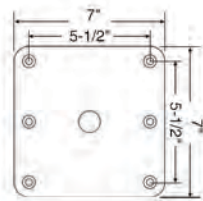

Threaded

KingPin™ bases are Rated ABYC Class H-31 B

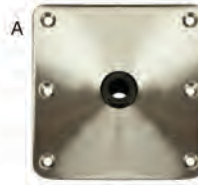

Satin Stainless Steel

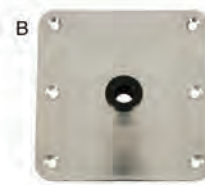

Polished Stainless Steel



Satin, Offset Bushing Stainless Steel

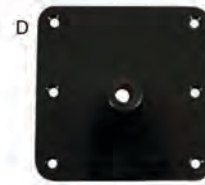

E-Coat Mild Steel



Black Krinkle Mild Steel



E-Coat, Offset Bushing Mild Steel

Threaded Rectangular Steel Bases

Retail

Image	Part Number	Base Size	Material	Finish	Bushing	Pack Quantity	ABYC
A.	1630004	6" x 8"	Stainless Steel	Satin	Nylon	6 Retail	B

OEM

Image	Part Number	Base Size	Material	Finish	Bushing	Pack Quantity	ABYC
A.	3630004	6" x 8"	Stainless Steel	Satin	Nylon	20 Pack	B
B.	3630004-BLK	6" x 8"	Mild Steel	Black Krinkle	Nylon	20 Pack	B
C.	3630004-EC	6" x 8"	Mild Steel	E-Coat	Nylon	20 Pack	B
D.	3630005	4" x 8"	Stainless Steel	Satin	Nylon	20 Pack	B
E.	3630005-P	4" x 8"	Stainless Steel	Polished	Nylon	20 Pack	B
F.	3630019	7" x 10"	Stainless Steel	Satin	Nylon	20 Pack	B

Retail packages are packed in clamshell with 4 color label

Threaded rectangular bases, available in stainless steel or mild steel with a variety of finishes. 4" cup depth. Below the deck mount (requires a 3-3/4" hole in deck).

Welded stainless steel nut for optimal support.



Threaded

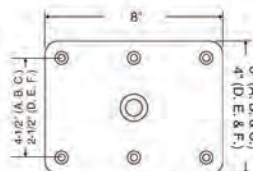

KingPin™ bases are Rated ABYC Class H-31 B



Satin Stainless Steel



Black Krinkle Mild Steel



E-Coat Mild Steel



Satin Stainless Steel



Polished Stainless Steel



Mill Finish Stainless Steel

Standard Square Aluminum Base

Retail							
Image	Part Number	Base Size	Material	Finish	Bushing	Pack Quantity	ABYC
A.	1620016	7" x 7"	Aluminum	Satin	Nylon	6 Retail	B

OEM							
Image	Part Number	Base Size	Material	Finish	Bushing	Pack Quantity	ABYC
A.	3620016	7" x 7"	Aluminum	Satin	Nylon	20 Pack	B

Retail packages are packed in clamshell with 4 color label

High-strength aluminum, satin finish, 3" cup depth.
Below the deck mount (requires a 2-1/2" hole in deck).
Use with any standard KingPin™ post (sold separately).

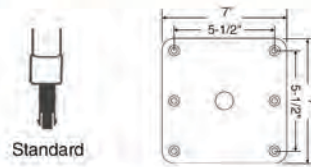

KingPin™ bases are Rated ABYC Class H-31 B



KingPin™ Round Base

Retail							
Image	Part Number	Base Size	Material	Finish	Bushing	Pack Quantity	ABYC
A.	1620017	8"	Aluminum	Powder Coat	Nylon	6 Retail	B
B.	1620017-S	8"	Aluminum	Satin	Nylon	6 Retail	B

OEM							
Image	Part Number	Base Size	Material	Finish	Bushing	Pack Quantity	ABYC
A.	3620017	8"	Aluminum	Powder Coat	Nylon	20 Pack	B
C.	3620025	5.5"	Stainless Steel	Polished	Nylon	20 Pack	B
D.	3620024	5" x 7" Oval	Stainless Steel	Polished	Nylon	20 Pack	B
D.	3630024	5" x 7" Oval	Stainless Steel	Polished	Nylon	20 Pack	B

Retail packages are packed in clamshell with 4 color label

Round bases, available in satin, powder coat, or polished finish. Below the deck mount, requires a 2-1/2" hole in deck.

Use with any standard KingPin™ post (sold separately).

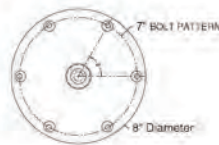

3630024 Threaded Base: Use with any threaded KingPin™ post (sold separately)

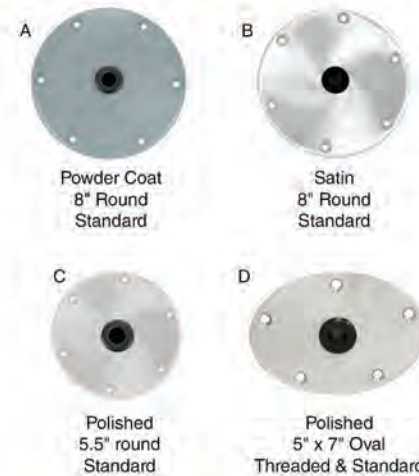

KingPin™ bases are Rated ABYC Class H-31 B



KingPin™ Accessories

Retail			
Image	Part Number	Description	Pack Quantity
A.	2100026	1-3/4" Stowable Post Clips	6 Pack
B.	2100032	Taper-Lock™ Adapter	6 Pack
C.	2100055	Nylon KingPin™ Bushing	6 Pack
D.	2100077	Brass KingPin™ Bushing	6 Pack
E.	2100094	Base Socket Cover	6 Pack

Retail			
Image	Part Number	Description	Pack Quantity
F.	2100175	KingPin™ Retention Clip	10 Pack
G.	3620760	Splash Guard for KingPin™ Bases	20 Pack

Provide convenient place to store your posts when not in use (sold in pairs as shown)



Inserts into Taper-Lock™ base to accept KingPin™ pedestals.



Nylon replacement bushing for KingPin™ bases



Brass replacement bushing for KingPin™ bases



Base socket cover



Plastic KingPin™ Retention Clip



Installed on base below deck to prevent water from entering into compartments below



Taper-Lock™ Series

ABOUT TAPER-LOCK™

Springfield Marine introduced the Taper-Lock™ pedestal system in 1982. Since then, over One Million units have been sold!

The design of the Taper-Lock™ provides the most stable, secure, and versatile systems in the industry. The slight taper of the high-strength composite bushing matches the corresponding taper in the socket of the pedestal base, thus creating a snug, secure fit that can be disengaged as needed. To prevent turning freely, the Taper-Lock™ bushing features a locking tab which also helps hold the pedestal firmly in place.

Ideal for fishing boats, the Taper-Lock™ has been widely used by many of the top-name boat builders in the industry for many years.



PACKAGES • SEAT MOUNTS • PEDESTALS • BASES • ACCESSORIES

Products in the Taper-Lock™ series are
DESIGNED FOR RECREATIONAL USE ONLY

Taper-Lock™

2-Piece Post Sets

Retail						
Image	Part Number	Description	Diameter	Finish	Pack Quantity	ABYC
A.	1600420	Hi-Lo 2-Piece Package	2-3/8"	Brite Dip	1 Retail	B
B.	1600607	Non-Locking 2-Piece Package	2-3/8"	Brite Dip	1 Retail	AP
C.	1600607-L	Locking 2-Piece Package	2-3/8"	Brite Dip	1 Retail	AD



2-Piece Sets are Rated
ABYC Class H-31 AD, AP, and B



2-Piece Hi-Lo set (A.) includes the following parts:

- Taper-Lock™ Hi-Lo polished post (#1600406)
- Taper-Lock™ Hi-Lo swivel (#1600205)

Use with any Taper-Lock™ base (sold separately)
16" from deck to top of swivel.

2-Piece set (B. & C.) includes the following parts:

- Taper-Lock™ 13" polished post (#1600406)
- Trac-Lock™ locking (C.) or non-locking (B.) 2-3/8" swivel

Use with any Taper-Lock™ base (sold separately)

This 2-position, 2-part system allows upright seating while fishing, OR compact storage and increased driver visibility while the boat is underway.



Taper-Lock™

Power-Rise Stand-Up Posts

Retail						
Image	Part Number	Description	Diameter	Finish	Pack Quantity	ABYC
A.	1602016	Stand-Up Post & Mount	2-3/8"	Brite Dip	1 Retail	B

OEM						
Image	Part Number	Description	Diameter	Finish	Pack Quantity	ABYC
B.	3601011	Stand-Up Post & Mount	2"	Brite Dip	2 Bulk	B

Retail packages are packed in clamshell with 4 color label

Adjusts from 22-1/2" to 29-1/2" and rotates 360°.
Brite dip finish. Available with or without seat mount.
Use with any Taper-Lock™ base (sold separately).



Taper-Lock™ Posts Are
Rated ABYC Class H-31 B



Power-Rise Sit Down Posts

Retail						
Image	Part Number	Description	Diameter	Finish	Pack Quantity	ABYC
A.	1601002-L	Locking Pedestal	2-3/8"	Brite Dip	1 Retail	B

OEM						
Image	Part Number	Description	Diameter	Finish	Pack Quantity	ABYC
B.	3601002	Non-Locking Pedestal	2-3/8"	Brite Dip	2 Bulk	B
A.	3601002-L	Locking Pedestal	2-3/8"	Brite Dip	2 Bulk	B

Retail packages are packed in clamshell with 4 color label

Adjusts from 13" to 19-1/8" and rotates 360°.
Use with any Taper-Lock™ base (sold separately)
Cam prevents free spinning while trailering
(on locking pedestals).



Taper-Lock™ Posts Are
Rated ABYC Class H-31 B



Taper-Lock™ Series

Power-Rise Stand-Up Packages

Retail					
Image	Part Number	Description	Pack Quantity	ABYC	
A.	1601037	Power-Rise Stand-Up Post Package	1 Retail	B	

Retail packed in box with 4 color label

Power-Rise set include the following parts:

- Power-Rise Stand-Up post
- Quik-Tilt seat mount (#1615254-EC)
- Gray Pro Stand-Up seat (#1040213)

Use with any Taper-Lock™ base (sold separately).



Taper-Lock™ Packages Are Rated ABYC Class H-31 B



Use as seat or leaning post adjusts from 25-1/2" to 32-1/2" (add 2-3/4" height for seat mount) (add 4-3/4" height for seat thickness) Rotates 360°, Quik-Tilt seat mount tilts in 4 snap-in angles (0°, 30°, 60°, 90°)

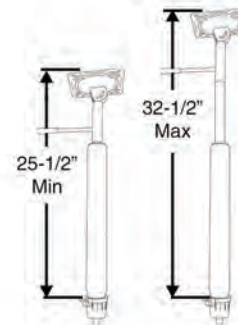

Taper-Lock™

Manual Adjustable Posts

Retail						
Image	Part Number	Adjusts	Diameter	Finish	Pack Quantity	ABYC
A.	1603824	21" to 31"	2-3/8"	Brite Dip	1 Retail	B
B.	1603825	13" to 16"	2-3/8"	Brite Dip	1 Retail	B

2-Piece sets include the following parts:

- 2-3/8" manual adjustable post (with posi-lock system)
- Trac-Lock™ non-locking 2-3/8" swivel (#1100031-1)

Use with any Taper-Lock™ base (sold separately).



Taper-Lock™ Posts are Rated ABYC Class H-31 B

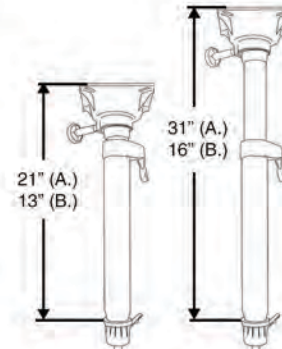

Trac-Lock™ Seat Mount For Taper-Lock™

Retail					
Image	Part Number	Description	Pack Quantity	ABYC	
A.	1100031-1	Non-Locking Trac-Lock™ Seat Mount	6 Retail	AP	
B.	1100031-L1	Locking Trac-Lock™ Seat Mount	6 Retail	AD	

OEM					
Image	Part Number	Description	Pack Quantity	ABYC	
A.	3100031-1	Non-Locking Trac-Lock™ Seat Mount	20 Bulk	AP	
B.	3100031-L1	Locking Trac-Lock™ Seat Mount	20 Bulk	AD	

Retail packages are packed in clamshell with 4 color label

High-strength aluminum with powder coat finish. Rotates 360°, 2-3/8" post mount with bushing for snug fit. Locking with centrally located locking handle, or non-locking swivel. Adds 3/4" to height of pedestal.

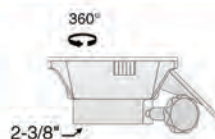
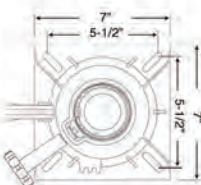

Trac-Lock™ Swivels Are Rated ABYC Class H-31 AD & AP

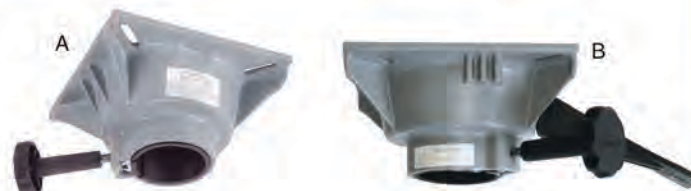

Hi-Lo Swivel

Retail						
Image	Part Number	Description	Pack Quantity	ABYC		
A.	1600205	Hi-Lo Swivel Seat Mount	6 Retail	B		

OEM						
Image	Part Number	Description	Pack Quantity	ABYC		
A.	3605205-EC	Hi-Lo Swivel Seat Mount	20 Bulk	B		

Retail packages are packed in clamshell with 4 color label

Aluminum cast powder coat finish.
Use with any Taper-Lock™ Hi-Lo post (sold separately).
Swivel adds 4" to height of post.

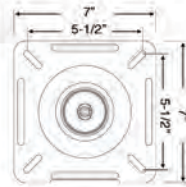

Hi-Lo Seat Mounts Are Rated
ABYC Class H-31 B



Fixed Height Hi-Lo Posts

Retail						
Image	Part Number	Fixed Height	Diameter	Finish	Pack Quantity	ABYC
A.	1600409	9"	2-3/8"	Brite Dip	6 Retail	B
A.	1600406	13"	2-3/8"	Brite Dip	6 Retail	B

OEM						
Image	Part Number	Fixed Height	Diameter	Finish	Pack Quantity	ABYC
A.	3600409	9"	2-3/8"	Brite Dip	20 Bulk	B
A.	3600406	13"	2-3/8"	Brite Dip	20 Bulk	B
B.	3600413	12"	2-3/8"	Anodized	20 Bulk	B

Retail packages are packed in clamshell with 4 color label

Use with seat mount #1600205 (sold separately)
Use with any Taper-Lock™ base (sold separately).
Contact us for additional post lengths.



Brite Dip



Anodized

Hi-Lo Posts Are Rated
ABYC Class H-31 B



Fixed Height Posts

Retail						
Image	Part Number	Description	Fixed Height	Finish	Pack Quantity	ABYC
A.	1600610	Non-Locking Post	13"	Brite Dip	6 Retail	AP
A.	1600611	Non-Locking Post	15"	Brite Dip	6 Retail	AP

OEM						
Image	Part Number	Description	Fixed Height	Finish	Pack Quantity	ABYC
A.	3600610	Non-Locking Post	13"	Brite Dip	20 Bulk	AP
B.	3600610-LD	Locking Post	13"	Brite Dip	20 Bulk	AD

Retail packages are packed in clamshell with 4 color label

Locking or non-locking 2-3/8" posts with brite dip finish.
Use with locking or non-locking Trac-Lock™ swivel (sold separately).
Use with any Taper-Lock™ base (sold separately).
Contact us for additional post lengths.



Fixed Height Posts Are Rated
ABYC Class H-31 AD & AP



Taper-Lock™ Series

9" Aluminum Bases

Retail

Image	Part Number	Size	Shape	Finish	Pack Quantity
B.	1600003	9"	Round Base	Satin	6 Retail
C.	1600005	9"	Flat Side Base	Satin	6 Retail
D.	1600008	9" x 5-1/8"	Double Flat Side	Satin	6 Retail
E.	1600010	9"	Round Surface Mount	Satin	6 Retail

OEM

Image	Part Number	Size	Shape	Finish	Pack Quantity
A.	3600002-A	9"	Round Base	Anodized	20 Bulk
B.	3600003	9"	Round Base	Satin	20 Bulk
C.	3600005	9"	Flat Side Base	Satin	20 Bulk
D.	3600008	9" x 5-1/8"	Double Flat Side	Satin	20 Bulk
E.	3600010	9"	Round Surface Mount	Satin	20 Bulk

High-strength aluminum to withstand all conditions. Below the deck mount -- requires a 3-1/2" hole in deck. 8" mounting hole pattern. Flat side bases for limited space applications. Use with any Taper-Lock™ post (sold separately).

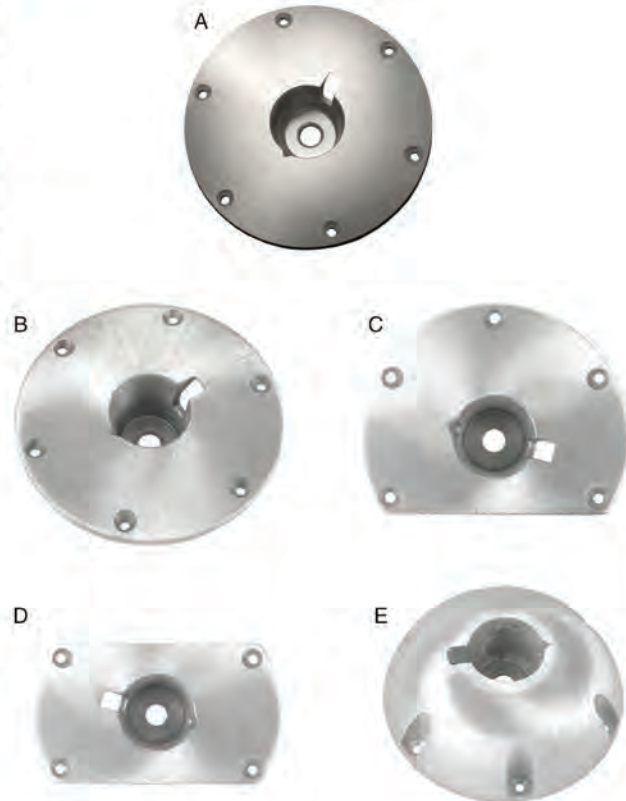
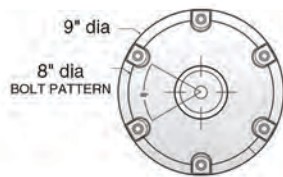

Taper-Lock™

Taper-Lock™ Accessories

Retail

Image	Part Number	Description	Pack Quantity
A.	2100031	Power Pedestal Repair Kit	6 Pack
B.	2171003	Seat Swivel Bushing	6 Pack
C.	2171004	Post Bottom Bushing	6 Pack
D.	2171032	2-3/8" Hi-Lo Bushing	6 Pack

All the parts needed to repair a worn or broken power pedestal



Replacement bushing for Taper-Lock™ swivels



Replacement bushing for Taper-Lock™ posts



Composite bushing for 2-3/8" Hi-Lo posts



ABOUT *PLUG-IN™*

Springfield Marine's removable pedestal series includes the Plug-In™. Stainless steel hardware, high-strength aluminum, and engineering grade plastics are used throughout to ensure the highest quality of all parts.

The Plug-In™ series features a unique notched and keyed design that provides security against rotation in the base and seat mount. Once the post is securely engaged into the base, the Plug-In™ provides a safe and stable seating system for your comfort.

This strong and sturdy interlocking design has continued to make the Plug-In™ series an ongoing popular choice of removable pedestal systems for boats used in punishing freshwater conditions.



PACKAGES • SEAT MOUNTS • PEDESTALS • BASES • ACCESSORIES



Plug-In™

Products in the Plug-In™ series are
DESIGNED FOR RECREATIONAL USE ONLY

Plug-In™ Series

2-3/8" 3-Piece Pedestal Sets

Retail					
Image	Part Number	Description	Unit Height	Pack Quantity	ABYC
A.	1300709-HL1	Hi-Lo 3-Piece Package	9"	1 Retail	B
A.	1300712-HL1	Hi-Lo 3-Piece Package	12"	1 Retail	B
A.	1300715-HL1	Hi-Lo 3-Piece Package	15"	1 Retail	B
B.	1300709-L1	Locking 3-Piece Package	9"	1 Retail	AD
B.	1300712-L1	Locking 3-Piece Package	12"	1 Retail	AD
B.	1300715-L1	Locking 3-Piece Package	15"	1 Retail	AD

Retail packages are packed in clamshell with 4 color label

Hi-Lo 3-Piece set (A.) includes the following parts:

- Plug-In™ Hi-Lo swivel seat mount (#1312700)
- Plug-In™ Hi-Lo fixed height post, anodized finish
- Plug-In™ 9" diameter base, satin finish (#1300751-1)

Locking 3-Piece set (B.) includes the following parts:

- Trac-Lock™ locking swivel seat mount (#1100031-L1)
- Plug-In™ fixed height post, anodized finish
- Plug-In™ 9" diameter base, satin finish (#1300750-1)

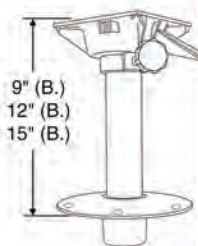
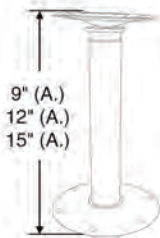

3-Piece Packages Are Rated
ABYC Class H-31 AD & B



Plug-In™

Power-Rise Stand-Up Posts

Retail					
Image	Part Number	Description	Pack Quantity	ABYC	
A.	1301037	3-Piece Power-Rise Stand-Up Package	1 Retail	B	
B.	1301038	2-Piece Power-Rise Stand-Up Package	1 Retail	B	

Retail packed in box with 4 color label

3-Piece set (A.) includes the following parts:

- Power-Rise Stand-Up post (#1303013)
- Quik-Tilt seat mount (#1615254-EC)
- Gray Pro Stand-Up Seat (#1040213)

2-Piece set (B.) includes the following parts:

- Power-Rise Stand-Up post (#1303013)
- Quik-Tilt seat mount (#1615254-EC)

High-strength aluminum pedestal.

Adjusts from 25-1/2" to 32-1/2"

Fits any 2-3/8" Plug-In™ base (sold separately).

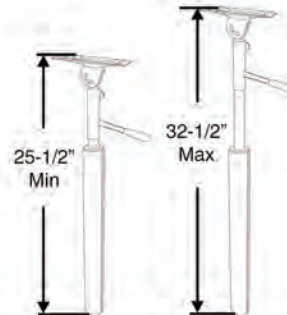

Plug-In™ Posts Are
Rated ABYC Class H-31 B



Power-Rise Air-Ride Posts

Retail					
Image	Part Number	Description	Adjusts	Pack Quantity	ABYC
A.	1300901	Locking Air-Ride Posts	14-1/4" to 21"	1 Retail	B
B.	1300902	Locking Air-Ride Posts	22-3/4" to 29-1/2"	1 Retail	B

OEM					
Image	Part Number	Description	Adjusts	Pack Quantity	ABYC
C.	3300900	Locking Air-Ride Posts	12-3/4" to 17-3/4"	2 Bulk	B
A.	3300901	Locking Air-Ride Posts	14-1/4" to 21"	2 Bulk	B
B.	3300902-AS	Locking Air-Ride Posts w/Sleeve	22-3/4" to 29-1/2"	2 Bulk	B

Retail packages are packed in clamshell with 4 color label

Posts can be locked in position to prevent rotating or unlocked to rotate freely. Provides safe, stable seating. Fits any 2-3/8" Plug-In™ base (sold separately).

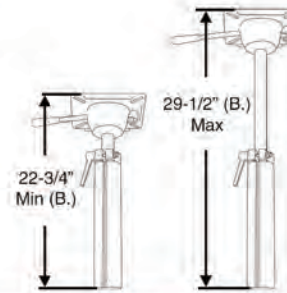
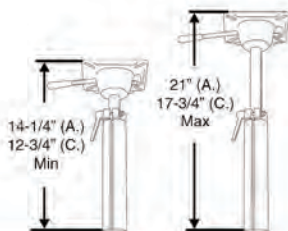

Plug-In™ Posts Are
Rated ABYC Class H-31 B



Power-Rise Air-Ride Package

Retail					
Image	Part Number	Description	Adjusts	Pack Quantity	ABYC
A.	1300601	Locking Trac-Lock™ Swivel	13-1/4" to 17-1/4"	1 Retail	AD
B.	1300601-AP	Non-Locking Trac-Lock™ Swivel	13-1/4" to 17-1/4"	1 Retail	AP



Plug-In™ Packages Are Rated ABYC Class H-31 AD & AP



OEM					
Image	Part Number	Description	Adjusts	Pack Quantity	ABYC
A.	3300601	Locking Trac-Lock™ Swivel	13-1/4" to 17-1/4"	2 Bulk	AD
B.	3300601-AP	Non-Locking Trac-Lock™ Swivel	13-1/4" to 17-1/4"	2 Bulk	AP

Retail packages are packed in box with 4 color label

High-strength aluminum post, adjusts from 13-1/4" to 17-1/4". Includes Trac-Lock™ locking or non-locking air-ride swivel. Fits any 2-3/8" Plug-In™ base (sold separately).



Trac-Lock™ Seat Mount For Plug-In™

Retail					
Image	Part Number	Description	Pack Quantity	ABYC	
A.	1100031-1	Non-Locking 2-3/8" Trac-Lock™ Swivel	6 Retail	AP	
B.	1100031-L1	Locking 2-3/8" Trac-Lock™ Swivel	6 Retail	AD	

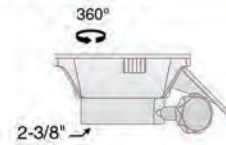

Trac-Lock™ Swivels Are Rated ABYC Class H-31 AD & AP



OEM					
Image	Part Number	Description	Pack Quantity	ABYC	
A.	3100031-1	Non-Locking 2-3/8" Trac-Lock™ Swivel	20 Bulk	AP	
B.	3100031-L1	Locking 2-3/8" Trac-Lock™ Swivel	20 Bulk	AD	

Retail packages are packed in clamshell with 4 color label

High-strength aluminum with powder coat finish. Rotates 360°, 2-3/8" post mount with bushing for snug fit. Locking with centrally located locking handle, or non-locking swivel. Adds 3/4" to height of pedestal.

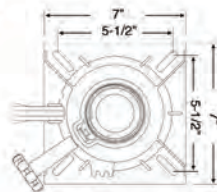

Hi-Lo Plug-In™ Seat Mount

Retail					
Image	Part Number	Description	Pin	Pack Quantity	ABYC
A.	1312701	Plug-In™ Hi-Lo Swivel	5" Pin	6 Retail	B

Plug-In™ Seat Mounts Are Rated ABYC Class H-31 B



OEM					
Image	Part Number	Description	Pin	Pack Quantity	ABYC
A.	3312701	Plug-In™ Hi-Lo Swivel	5" Pin	20 Bulk	B

Retail packages are packed in clamshell with 4 color label

Hi-Lo seat swivel adds 1-3/4" to height of post. Pin fits into Hi-Lo post for seating, or into Hi-Lo base for compact storage.



Seating Position

Storage Position

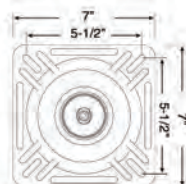

Plug-In™ Series

2-3/8" Locking Fixed Height Posts

Retail					
Image	Part Number	Description	Height	Pack Quantity	ABYC
A.	1300709	Locking 2-3/8" Post	9"	6 Retail	AD
A.	1300712	Locking 2-3/8" Post	12"	6 Retail	AD
A.	1300713	Locking 2-3/8" Post	13"	6 Retail	AD
A.	1300715	Locking 2-3/8" Post	15"	6 Retail	AD

OEM					
Image	Part Number	Description	Height	Pack Quantity	ABYC
A.	3300709	Locking 2-3/8" Post	9"	20 Pack	AD
A.	3300710	Locking 2-3/8" Post	10"	20 Pack	AD
A.	3300712	Locking 2-3/8" Post	12"	20 Pack	AD
A.	3300713	Locking 2-3/8" Post	13"	20 Pack	AD
A.	3300714	Locking 2-3/8" Post	14"	20 Pack	AD
A.	3300715	Locking 2-3/8" Post	15"	20 Pack	AD
A.	3300728	Locking 2-3/8" Post	28"	20 Pack	AD

Retail packages are packed in clamshell with 4 color label

Heights are from top of swivel to deck, when post is installed.
Anodized to withstand all conditions.
Fits into any 2-3/8" Plug-In™ base (sold separately).



Plug-In™ Posts Are Rated ABYC Class H-31 AD



Plug-In™

2-3/8" Locking Post With Latch

OEM					
Image	Part Number	Description	Height	Pack Quantity	ABYC
A.	3310708-L	Locking Post With Latch	8.5"	20 Bulk	AD
A.	3310709-L	Locking Post With Latch	9"	20 Bulk	AD
A.	3310712-L	Locking Post With Latch	12"	20 Bulk	AD
A.	3310714-L	Locking Post With Latch	14"	20 Bulk	AD
A.	3310715-L	Locking Post With Latch	15"	20 Bulk	AD

Locking 2-3/8" post with anodized finish.
Latch safely secures posts to base.
Heights are from top of swivel to deck, when post is installed.
Fits into any Plug-In™ base (sold separately).



Plug-In™ Posts Are Rated ABYC Class H-31 AD



2-3/8" Hi-Lo Posts

Retail					
Image	Part Number	Description	Height	Pack Quantity	ABYC
A.	1304012-HL	2-3/8" Hi-Lo Post	12"	6 Retail	B
A.	1304015-HL	2-3/8" Hi-Lo Post	15"	6 Retail	B

OEM					
Image	Part Number	Description	Height	Pack Quantity	ABYC
A.	3300709-HL	2-3/8" Hi-Lo Post	9"	20 Bulk	B
A.	3300712-HL	2-3/8" Hi-Lo Post	12"	20 Bulk	B
A.	3300713-HL	2-3/8" Hi-Lo Post	13"	20 Bulk	B
A.	3300715-HL	2-3/8" Hi-Lo Post	15"	20 Bulk	B

Retail packages are packed in clamshell with 4 color label

Available in a variety of heights with high-strength anodized aluminum finish.
Heights are from top of swivel to deck, when post is installed.
Use with Plug-In™ Hi-Lo seat mount (sold separately).
Use with 2-3/8" Plug-In™ bases (sold separately).



Plug-In™ Posts Are Rated ABYC Class H-31 B



Hole in top of post for Hi-Lo seat mount

9" Round Aluminum Bases

Retail					
Image	Part Number	Description	Size	Finish	Pack Quantity
A.	1300750-1	2-3/8" Base	9"	Satin	6 Retail
B.	1300750-A1	2-3/8" Base	9"	Anodized	6 Retail
C.	1300751-1	2-3/8" Hi-Lo Base	9"	Satin	6 Retail

OEM					
Image	Part Number	Description	Size	Finish	Pack Quantity
A.	3300750-1	2-3/8" Base	9"	Satin	20 Bulk
B.	3300750-A1	2-3/8" Base	9"	Anodized	20 Bulk
C.	3300751-1	2-3/8" Hi-Lo Base	9"	Satin	20 Bulk
D.	3300751-A1	2-3/8" Hi-Lo Base	9"	Anodized	20 Bulk
E.	3301750-1	2-3/8" Flush Mount	9"	Satin	20 Bulk
F.	3300764-PP1	2-3/8" Base	5.5"	Polished	20 Bulk

Retail packages are packed in clamshell with 4 color label

9" round aluminum base with 8" mounting hole pattern. Below the deck mount (requires a 3-3/4" hole in deck). Surface mount (E.) does not require a hole in deck. Use with any 2-3/8" Plug-In™ post (sold separately).

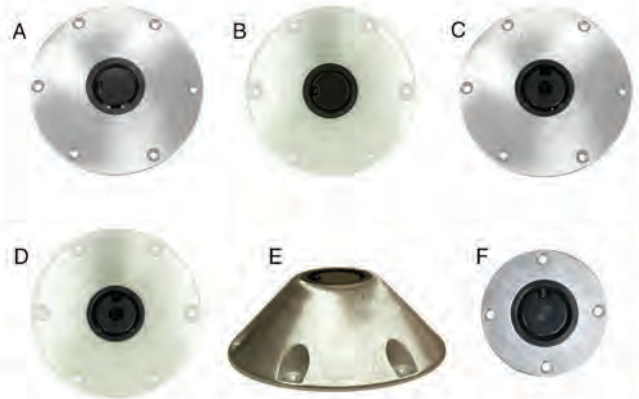

Flat Sided Aluminum Bases

Retail				
Image	Part Number	Description	Finish	Pack Quantity
A.	1300750-L1	Left Flat Sided Base	Satin	6 Retail
B.	1300750-R1	Right Flat Sided Base	Satin	6 Retail

OEM				
Image	Part Number	Description	Finish	Pack Quantity
A.	3300750-L1	Left Flat Sided Base	Satin	20 Bulk
B.	3300750-R1	Right Flat Sided Base	Satin	20 Bulk
C.	3300750-AR1	Right Flat Sided Base	Anodized	20 Bulk
D.	3300750-D1	Double Flat Sided Base	Satin	20 Bulk

Retail packages are packed in clamshell with 4 color label

- Left Flat (A.): 9" x 7", flat side is on same side as notch
- Right Flat (B. & C.): 9" x 7", flat side is on opposite side as notch
- Dbl Flat (D.): 9" x 5-1/4", both sides are flat

Use with any 2-3/8" Plug-In™ post (sold separately).

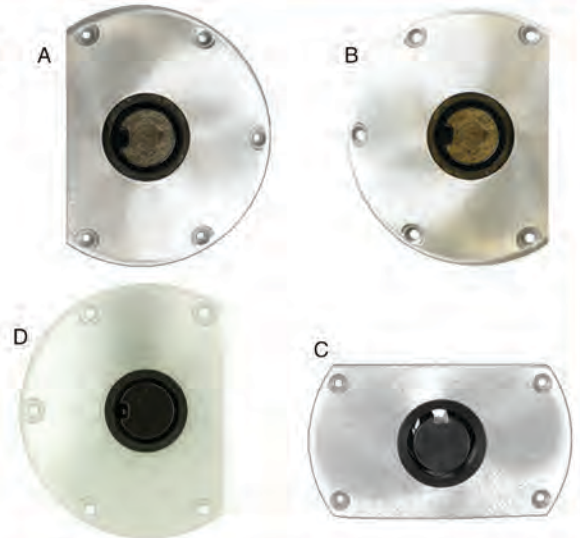

Square And Rectangular Bases

Retail					
Image	Part Number	Material	Size	Finish	Pack Quantity
A.	1300754-1	Stainless Steel	7" x 7"	Satin	1 Retail

OEM					
Image	Part Number	Material	Size	Finish	Pack Quantity
B.	3300753-1	Mild Steel	7" x 7"	E-Coat	20 Bulk
C.	3300752-CR1	Mild Steel	7" x 7"	E-Coat	20 Bulk
D.	3300752-D	Stainless Steel	5" x 7"	Satin	20 Bulk
E.	3300753-K1	Mild Steel	7" x 7"	Black Krinkle	20 Bulk
A.	3300754-1	Stainless Steel	7" x 7"	Satin	20 Bulk
F.	3300757-D1	Mild Steel	5" x 7"	E-Coat	20 Bulk
G.	3300758-1	Stainless Steel	7" x 7"	Mill	20 Bulk
H.	3300759-PP1	Stainless Steel	7" x 7"	Polished	20 Bulk

Retail packages are packed in clamshell with 4 color label

Made of stainless steel or mild steel. Below the deck mount (requires a 3-3/4" hole in deck). Suitable for above or under carpet applications. Use with any 2-3/8" Plug-In™ post. (sold separately).

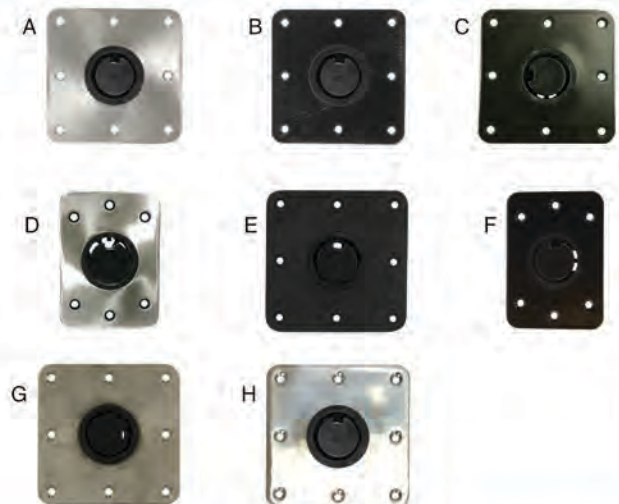

Plug-In™ Series

2-7/8" Trac-Lock™ Swivel

Retail				
Image	Part Number	Description	Pack Quantity	ABYC
A.	1100021-L1	Locking 2-7/8" Trac-Lock™ Swivel	6 Retail	AD

OEM				
Image	Part Number	Description	Pack Quantity	ABYC
A.	3100021-L1	Locking 2-7/8" Trac-Lock™ Swivel	20 Bulk	AD

High-strength aluminum with powder coat finish.
2-7/8" post mount with bushing for snug fit.
Locking with centrally located locking handle.

2-7/8" Trac-Lock™ Are
Rated ABYC Class H-31 AD

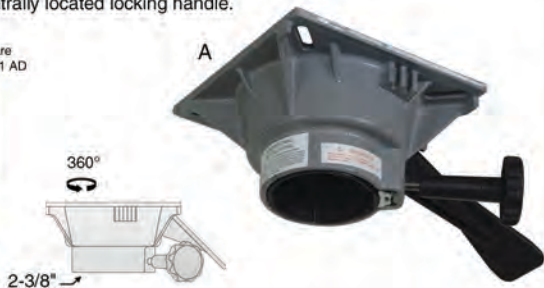

2-7/8" Locking Fixed Height Posts

OEM					
Image	Part Number	Description	Height	Pack Quantity	ABYC
A.	3301809	Locking 2-7/8" Post	9"	20 Bulk	AD
B.	3301812	Locking 2-7/8" Post	12"	20 Bulk	AD
C.	3301816	Locking 2-7/8" Post	16"	20 Bulk	AD
D.	3301818	Locking 2-7/8" Post	18"	20 Bulk	AD

Anodized finish to withstand all conditions.
Use with Trac-Lock™ locking swivel (sold separately).
Fits into 2-7/8" Plug-In™ Base (sold separately).
Heights are from top of swivel to deck, when post is installed.

Plug-In™ Posts Are
Rated ABYC Class H-31 AD



9" Round 2-7/8" Bases

OEM					
Image	Part Number	Description	Finish	Pack Quantity	ABYC
A.	3300850-A1	2-7/8" Round Plug-In™ Base	Anodized	20 Bulk	AD

High-strength aluminum, with satin or anodized finish.
9" diameter base with 8" mounting hole pattern.
Fits any 2-7/8" Plug-In™ post (sold separately).

2-7/8" Plug-In™ Bases Are
Rated ABYC Class H-31 AD

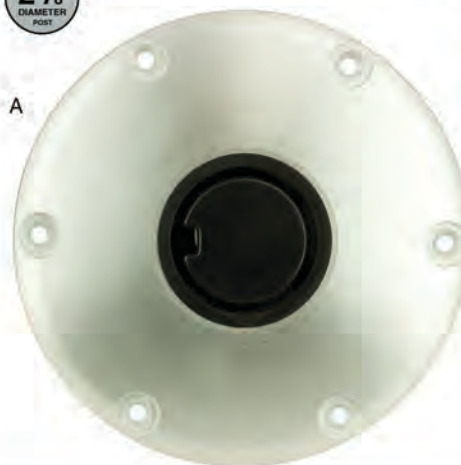

Plug-In™ Accessories

OEM			
Image	Part Number	Description	Pack Quantity
B.	3300760	2-3/8" Splash Guard Cup	20 Bulk
C.	3300762	2-7/8" Splash Guard Cup	20 Bulk
D.	3300766	2-3/8" Hi-Lo Replacement Bushing	20 Bulk
E.	3300767	2-3/8" Splash Guard Cup (use with drain hose)	20 Bulk



2-3/8" aluminum splash guard.



2-7/8" aluminum splash guard.



2-3/8" Hi-Lo replacement bushing.



2-3/8" aluminum splashguard with drain.

ABOUT THREAD-LOCK™

Springfield Marine originally introduced the Thread-Lock™ to be used as a table system. Soon we adapted our post-style grill to use the same attachment as the table.

The success of those two products made way for the redesign of the post and base for use as a seating system. A locking mechanism was added to the seat post to provide a secure and wobble free experience in both fishing models as well as underway models.

Thread-Lock's™ interchangeable parts allow the seating base to be used with the grill or table. The perfect base for a fishing deck... simply remove the seating post, install the grill or table, and enjoy. However, the seat post will not fit into the table base.

With the Thread-Lock™ system, attaching the post to the base is as easy as turning on a light bulb. And the locking collar gives you peace of mind that your post stays on the base... safe and secure.



Use On Pontoon Boats

PACKAGES • SEAT MOUNTS • PEDESTALS • BASES • ACCESSORIES

Thread-Lock™

Products in the Thread-Lock™ series are
DESIGNED FOR RECREATIONAL USE ONLY

Thread-Lock™ Series

3-Piece Pedestal Package

Retail					
Image	Part Number	Description	Unit Height	Pack Quantity	ABYC
A.	1793113	3-Piece Set (for fishing)	15-1/2"	1 Retail	B
B.	1793313	3-Piece Set (for use underway)	14"	1 Retail	AP

Retail packages are packed in clamshell with 4 color label



3-Piece Sets Are Rated
ABYC Class H-31 AP & B



3-Piece set (A.) includes the following parts:

- Thread-Lock™ 13" fixed height post (#3793213)
- KingPin™ swivel seat mount (#1615201-EC)
- Thread-Lock™ 9" base (#3790001-SL)

3-Piece set (B.) includes the following parts:

- Thread-Lock™ 13" fixed height post (#3793013-A)
- Trc-Lock™ non-locking swivel seat mount (#1100031-1)
- Thread-Lock™ 9" base (#3790001-SL)



Trac-Lock™ Seat Mount For Thread-Lock™

Retail					
Image	Part Number	Description	Diameter	Pack Quantity	ABYC
A.	1100031-1	Non-Locking Seat Mount	2-3/8"	6 Retail	AP

OEM					
Image	Part Number	Description	Diameter	Pack Quantity	ABYC
A.	3100031-1	Non-Locking Seat Mount	2-3/8"	20 Bulk	AP

Retail packages are packed in clamshell with 4 color label



Trac-Lock™ Seat Mounts Are
Rated ABYC Class H-31 AP



High-strength aluminum with powder coat finish.
Use with 2-3/8" Fixed height posts (for underway).
Swivel rotates 360° and adds 3/4" to height of pedestal.

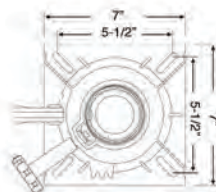

KingPin™ Seat Mount For Thread-Lock™

Retail					
Image	Part Number	Description	Finish	Pack Quantity	ABYC
A.	1615207-ECB	Hi-Rise Seat Mount	Powder Coat	6 Retail	B
B.	1615204-EC	Seat Mount, No Spring	E-Coat	6 Retail	B

OEM					
Image	Part Number	Description	Finish	Pack Quantity	ABYC
A.	3615207-ECB	Hi-Rise Seat Mount	Powder Coat	20 Bulk	B
B.	3615204-EC	Seat Mount, No Spring	E-Coat	20 Bulk	B

Retail packages are packed in clamshell with 4 color label



KingPin™ Seat Mounts Are
Rated ABYC Class H-31 B



Unintentional detachment to comply with ABYC.
7" x 7" swivel rotates 360°.
Use with fixed height posts (for fishing only).

Hi-Rise seat mount adds 2-11/16" to height of post.

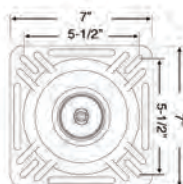

Fixed Height Posts (for use underway)

OEM						
Image	Part Number	Diameter	Height	Finish	Pack Quantity	ABYC
A.	3793012-A	2-3/8"	12"	Anodized	20 Bulk	AP
B.	3793012-P	2-3/8"	12"	Polished	20 Bulk	AP
A.	3793013-A	2-3/8"	13"	Anodized	20 Bulk	AP
B.	3793014-P	2-3/8"	14"	Polished	20 Bulk	AP

Sturdy 2-3/8" high-strength aluminum posts. Available as anodized or polished. Locking collar prevents unintentional removal from base. Use with Trac-Lock™ non-locking seat mount, (sold separately).



Underway Posts Are Rated ABYC Class H-31 AP



Hi-Lo Fixed Height Posts (for fishing only)

OEM						
Image	Part Number	Diameter	Height	Finish	Pack Quantity	ABYC
A.	3793211	2-3/8"	11"	Anodized	20 Bulk	B
B.	3793212	2-3/8"	12"	Anodized	20 Bulk	B
C.	3793213	2-3/8"	13"	Anodized	20 Bulk	B

Sturdy 2-3/8" high-strength aluminum posts anodized finish. Bottom locking collar prevents unintentional removal from base.

Use with KingPin™ seat mount, (sold separately). Use with any Thread-Lock™ base (sold separately).

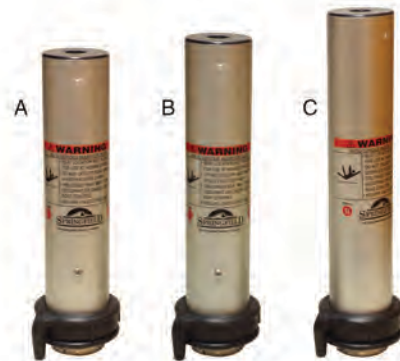

Fishing Posts Are Rated ABYC Class H-31 B



Aluminum Bases

OEM				
Image	Part Number	Diameter	Finish	Pack Quantity
A.	3796009-SL	9" Base	Satin	20 Bulk
B.	3796010-AL	10" Base	Anodized	20 Bulk
C.	3796010-PL	10" Base	Polished	20 Bulk
A.	3796010-SL	10" Base	Satin	20 Bulk

High-strength aluminum bases, available as polished, anodized, or satin finish. No hole in deck required.

Use with any Thread-Lock™ fixed height post (sold separately). Can also be used with Thread-Lock™ Table and Grill posts (sold separately).



Thread-Lock™ seating bases can also be used with Thread-Lock™ Grill and Table systems. DO NOT USE SEATING POSTS IN BASES MADE FOR GRILLS or TABLES.

Thread-Lock™ Accessories

Retail			
Image	Part Number	Description	Pack Quantity
A.	2100092	Plastic Base Socket Cover	6 Retail

OEM			
Image	Part Number	Description	Pack Quantity
A.	2100092-B	Plastic Base Socket Cover	20 Bulk

Plastic base socket cover keeps socket clear when not in use. Fits any Thread-Lock™ base.



Thread-Lock™

Spring-Lock™ Series

ABOUT SPRING-LOCK™

Springfield Marine presents Spring-Lock™ ... the world's first push button activated pedestal. The industry demanded it -- we created it. Tired of problems resulting from similar sized plastic bases, the industry needed a new pedestal system that could retrofit with plastic-base units already in use.

With Spring-Lock™ pedestals, we've combined a sturdy and secure ride with fast and easy post removal. The locking latch of the Spring-Lock™ extends from the post and secures it in the base. A push of the button and the latch unlocks the post from the base for easy removal.

For an even simpler approach, Springfield Marine presents the Clip-Lock even better performance and an easier-to-use system. Designed to capture the end of the post, the base provides all the strength needed to hold it in place during punishing freshwater action. Simply plug the Clip-Lock into the base and go. When you are done, a simple pull on the post removes it up and out of the base.

Use On  Fishing Boats



Products in the Spring-Lock™ / Clip-Lock series are
DESIGNED FOR RECREATIONAL USE ONLY

Spring-Lock™

PACKAGES • SEAT MOUNTS • PEDESTALS • BASES • ACCESSORIES

Clip-Lock 3-Piece Packages

Retail					
Image	Part Number	Description	Pack Quantity	ABYC	
A.	1644513-S	3-Piece Non-Locking Package	1 Retail	B	

Retail packed in box with 4 color label

3-Piece set (A.) includes the following parts:

- 13" Clip-Lock non-locking satin post (#3640513-S)
- Spring-Lock™ Non-Locking Swivel (#3640202)
- 7" x 7" non-locking square base (#3640013-CL)

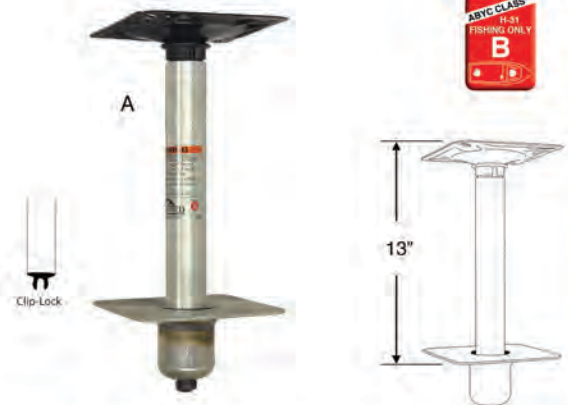

Power-Rise Adjustable Sit Down Posts

Retail						
Image	Part Number	Material	Adjusts	Finish	Pack Quantity	ABYC
A.	1642005	Stainless Steel	15-1/2" to 21-1/2"	Polished	1 Retail	B

OEM						
Image	Part Number	Material	Adjusts	Finish	Pack Quantity	ABYC
A.	3641007	Stainless Steel	15-1/2" to 21-1/2"	Polished	2 Bulk	B
A.	3641013	Stainless Steel	13-1/2" to 18"	Polished	2 Bulk	B
B.	3641507	Aluminum	16-1/2" to 22-1/2"	Satin	2 Bulk	B
B.	3641507-BAS	Aluminum	16-1/2" to 22-1/2"	Brite Dip	2 Bulk	B

Retail packages are packed in clamshell with 4 color label

Spring-Lock™ (A.) sit down posts

Adjustable height from 13-1/2" to 20" (unless noted).
3 degree tilt cast aluminum swivel, rotates 360°.
Use with any non-locking Spring-Lock™ base, (sold separately).

Clip-Lock (B.) sit down posts

Adjustable height from 16" to 29-1/2".
3 degree tilt cast aluminum swivel, rotates 360°.
Use with any non-locking Spring-Lock™ base, (sold separately).



Power-Rise Adjustable Stand-Up Post

Retail						
Image	Part Number	Material	Adjusts	Finish	Pack Quantity	ABYC
A.	1642008	Stainless Steel	22-1/2" to 29-1/2"	Polished	1 Retail	B
B.	1641508	Aluminum	22-1/2" to 29-1/2"	Satin	1 Retail	B

OEM						
Image	Part Number	Material	Adjusts	Finish	Pack Quantity	ABYC
A.	1641009	Stainless Steel	22-1/2" to 29-1/2"	Polished	1 OEM	B
A.	1641019	Stainless Steel	25-1/2" to 32-1/4"	Polished	1 OEM	B

Retail packages are packed in clamshell with 4 color label

Spring-Lock™ (A.) stand up posts

Height adjusts from 22-1/2" to 29-1/2" (unless noted).
3 degree tilt cast aluminum swivel, rotates 360°.
Use with any non-locking Spring-Lock™ base.

Clip-Lock™ (B.) stand up posts

Height adjusts from 22-1/2" to 29-1/2" (unless noted).
3 degree tilt cast aluminum swivel, rotates 360°.
Use with any non-locking Spring-Lock™ base.



Spring-Lock™ Series

Power-Rise Stand-Up Package

Retail				
Image	Part Number	Description	Pack Quantity	ABYC
A.	1641037	Power-Rise Stand-Up Package	1 Retail	B
B.	1643013	Power-Rise Stand-Up Post	1 Retail	B

Retail packed in box with 4 color label

3-Piece set (A.) includes the following parts:

- Power-Rise Stand-Up post (#1641037)
- Quik-Tilt seat mount (#1615254-EC)
- Gray pro stand up seat (#1040213)

(1643013) Stainless steel post.
Adjusts from 25-1/2" to 32-1/2". Use with any non-locking Spring-Lock™ base (sold separately).

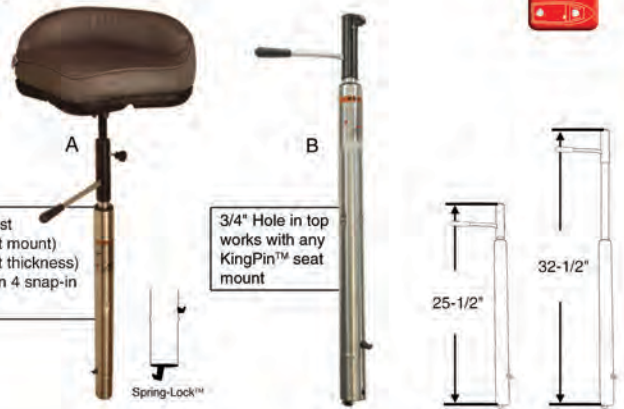

Non-Locking Seat Mounts

Retail					
Image	Part Number	Description	Finish	Pack Quantity	ABYC
A.	1640202	Spring-Lock™ Seat Mount	E-Coat	1 Retail	B
B.	1640203	Hi-Rise Seat Mount	E-Coat	1 Retail	B

OEM					
Image	Part Number	Description	Finish	Pack Quantity	ABYC
A.	3640202	Spring-Lock™ Seat Mount	E-Coat	20 Bulk	B
B.	3640203	Hi-Rise Seat Mount	E-Coat	20 Bulk	B

Retail packages are packed in clamshell with 4 color label

Use with any Spring-Lock™ or Clip-lock non-locking posts.
E-coat finish to resist corrosion.

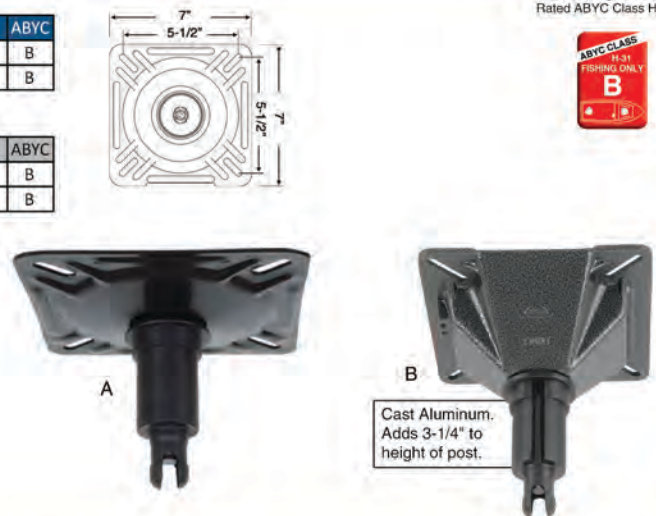

Locking Seat Mounts

Retail					
Image	Part Number	Description	Finish	Pack Quantity	ABYC
A.	1680203	Locking Spring-Lock™ Seat Mount	Powder Coat	1 Retail	AD

OEM					
Image	Part Number	Description	Finish	Pack Quantity	ABYC
A.	3680203	Locking Spring-Lock™ Seat Mount	Powder Coat	20 Bulk	AD

Retail packages are packed in clamshell with 4 color label

Use with any locking Spring-Lock™ post.
Powder coat finish to resist corrosion.
Swivel adds 1/4" to height of pedestal.



Spring-Lock™ Non-Locking Posts

Retail					
Image	Part Number	Description	Height	Pack Quantity	ABYC
A.	1640401	Non-Locking Offset Post	13"	6 Retail	B
B.	1640404	Non-Locking Post	13-1/2"	6 Retail	B
B.	1640403	Non-Locking Post	15-1/2"	6 Retail	B
B.	1640425	Non-Locking Post	25"	6 Retail	B

OEM					
Image	Part Number	Description	Height	Pack Quantity	ABYC
B.	3640411	Non-Locking Post	11-1/2"	20 Bulk	B
A.	3640401	Non-Locking Offset Post	13"	20 Bulk	B
B.	3640413	Non-Locking Post	13-1/2"	20 Bulk	B
B.	3640415	Non-Locking Post	15-1/2"	20 Bulk	B
B.	3640420	Non-Locking Post	18-3/4"	20 Bulk	B
B.	3640425	Non-Locking Post	25"	10 Bulk	B

Retail packages are packed in clamshell with 4 color label

Hefty 1-3/4" diameter stainless steel posts.
Use with non-locking Spring-Lock™ seat mounts (sold separately).
Use with any non-locking Spring-Lock™ base (sold separately).



Spring-Lock™ Locking Posts

Retail					
Image	Part Number	Description	Height	Pack Quantity	ABYC
A.	1680409	Locking Spring-Lock™ Post	9-3/4"	6 Retail	AD
A.	1680411	Locking Spring-Lock™ Post	11-1/4"	6 Retail	AD
A.	1680415	Locking Spring-Lock™ Post	15-1/2"	6 Retail	AD
A.	1680418	Locking Spring-Lock™ Post	18"	6 Retail	AD

OEM					
Image	Part Number	Description	Height	Pack Quantity	ABYC
A.	3680409	Locking Spring-Lock™ Post	9-3/4"	20 Bulk	AD
A.	3680411	Locking Spring-Lock™ Post	11-1/4"	20 Bulk	AD
A.	3680412	Locking Spring-Lock™ Post	12-3/4"	20 Bulk	AD
A.	3680413	Locking Spring-Lock™ Post	13-1/2"	20 Bulk	AD
A.	3680415	Locking Spring-Lock™ Post	15-1/2"	20 Bulk	AD
A.	3680418	Locking Spring-Lock™ Post	18"	20 Bulk	AD

Retail packages are packed in clamshell with 4 color label

Hefty 1-3/4" diameter stainless steel posts.
Use with locking Spring-Lock™ seat mounts (sold separately).
Use with any locking Spring-Lock™ base (sold separately).



Clip-Lock Non-Locking Posts

OEM						
Image	Part Number	Description	Height	Finish	Pack Quantity	ABYC
A.	3640511-S	Non-Locking Post	11"	Satin	20 Bulk	B
B.	3640513-A	Non-Locking Post	13-1/2"	Anodized	20 Bulk	B
A.	3640513-S	Non-Locking Post	13"	Satin	20 Bulk	B

Hefty 1-3/4" high-strength aluminum, available in a satin or anodized finish.

Use with Spring-Lock™ non-locking seat mounts (sold separately).
Use with any Spring-Lock™ non-locking base (sold separately).



Spring-Lock™ Series

9" Non-Locking Round Bases

Retail						
Image	Part Number	Description	Size	Finish	Pack Quantity	ABYC
A.	1640002	Non-Locking Base	9"	Satin	6 Retail	B

Retail						
Image	Part Number	Description	Size	Finish	Pack Quantity	ABYC
A.	3640002	Non-Locking Base	9"	Satin	20 Bulk	B
B.	3640002-CLA	Non-Locking Base	9"	Anodized	20 Bulk	B

Retail packages are packed in clamshell with 4 color label

8" hole pattern, high-strength aluminum.
Below the deck mount (requires a 4" hole in deck).
Use with any Spring-Lock™ or Clip-Lock post,
(sold separately).

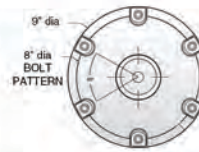

Non-Locking Bases Are Rated ABYC Class H-31 B

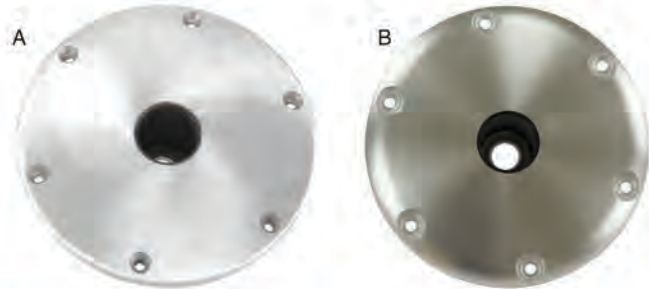

Non-Locking Rectangular Bases

Retail						
Image	Part Number	Description	Size	Finish	Pack Quantity	ABYC
A.	3640022-PPCL	Non-Locking Base	5" x 7"	Polished	20 Bulk	B
B.	3640024-CL	Non-Locking Base	6" x 8"	Satin/E-Coat	20 Bulk	B
C.	3640025-CL	Non-Locking Base	7" x 10"	Satin	20 Bulk	B
D.	3640026-CL	Non-Locking Base	7" x 10"	E-Coat	20 Bulk	B

Bases are stainless steel or mild steel.
Below the deck mount (requires a 4" hole in deck).
Use with any Spring-Lock™ or Clip-Lock post,
(sold separately).

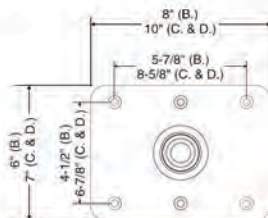

Stainless Steel

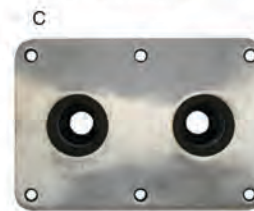

Double Socket
Stainless Steel

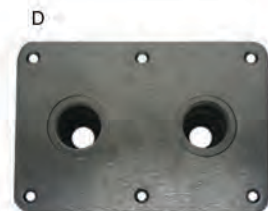

Double Socket
Mild Steel

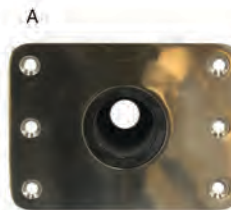

Stainless Steel

Non-Locking Bases Are Rated ABYC Class H-31 B



7" x 7" Non-Locking Square Bases

Retail						
Image	Part Number	Description	Material	Finish	Pack Quantity	ABYC
A.	1640007-CL	7" x 7" Base	Mild Steel	Black Krinkle	6 Retail	B
C.	1640012-PASSCL	7" x 7" Base	Stainless Steel	Polished	6 Retail	B
D.	1640013-CL	7" x 7" Base	Stainless Steel	Satin	6 Retail	B

OEM						
Image	Part Number	Description	Material	Finish	Pack Quantity	ABYC
A.	3640007-CL	7" x 7" Base	Mild Steel	Black Krinkle	20 Bulk	B
B.	3640012-CL	7" x 7" For Under Carpet	Stainless Steel	Mill	20 Bulk	B
C.	3640012-PASSCL	7" x 7" Base	Stainless Steel	Polished	20 Bulk	B
D.	3640013-CL	7" x 7" Base	Stainless Steel	Satin	20 Bulk	B
E.	3640021-CL	7" x 7" Offset Base	Mild Steel	Black Krinkle	20 Bulk	B

Retail packages are packed in clamshell with 4 color label

Bases are stainless steel or mild steel.
Available in a variety of finishes.
Below the deck mount (requires a 4" hole in deck).
Use with any Spring-Lock™ or Clip-Lock post.

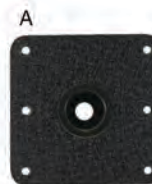
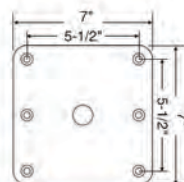

Black Krinkle

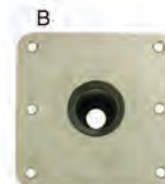

Mill

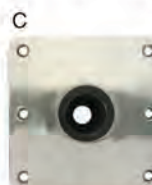

Polished

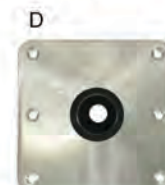

Satin



Black Krinkle
Offset Bushing

Non-Locking Bases Are Rated ABYC Class H-31 B



7" x 7" Locking Square Bases

OEM						
Image	Part Number	Description	Material	Finish	Pack Quantity	ABYC
A.	368007-CL	7" x 7" Base	Mild Steel	Black Krinkle	20 Bulk	AD
B.	3680012-CL	7" x 7" For Under Carpet	Stainless Steel	Mill	20 Bulk	AD
C.	3680012-PASSCL	7" x 7" Base	Stainless Steel	Polished	20 Bulk	AD
D.	3680013-CL	7" x 7" Base	Stainless Steel	Satin	20 Bulk	AD

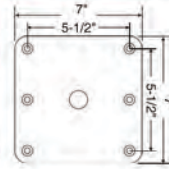

Locking Bases Are Rated
ABYC Class H-31 AD



Bases are available as mild, or stainless steel construction.
Below the deck mount requires a 4" hole in deck.
Use with any locking Spring-Lock™ post, (sold separately).



Black Krinkle



Mill



Polished

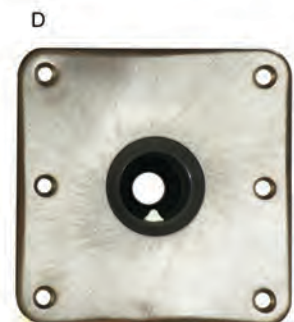

Satin

Spring-Lock™ & Clip-Lock Accessories

Retail			
Image	Part Number	Description	Pack Quantity
A.	2100010	Replacement Seat Mount Bushing	6 Pack
B.	2100011	Replacement Locking Latch	6 Pack
C.	2100012	Replacement End Cap	6 Pack
D.	2100013	Replacement Post Bushing	6 Pack
E.	2100038	Mild Steel Base Repair Kit	6 Pack
F.	2100038-SS	Stainless Steel Base Repair Kit	6 Pack
G.	2100040	Spring-Lock™ 2 Base Repair Kit	6 Pack
H.	2100091	Base Socket Cover	6 Pack

OEM			
Image	Part Number	Description	Pack Quantity
H.	2100091-B	Base Socket Cover	20 Bulk
I.	3640023	Splash Guard	20 Bulk

Base repair kits include: 1/2 oz bottle of glue with brush cap, plastic bushing, and wooden dowel mandrel.

Used on mild steel bases, 1999 and after

Used on stainless steel bases, pre 1999

Used on current Spring-Lock™ 2 bases



Replacement Parts For Spring-Lock™



A. Seat Mount Bushing



B. Locking Latch



C. End Cap



D. Post Bushing

H. 3/4" deck base socket cover (sold as single pieces)



I. Installed on base below deck to prevent water from entering into compartments below



2-3/8" Series

ABOUT 2-3/8" SERIES

2-3/8" Seat Mounts include: The Trac-Lock™ series. Made from high-strength aluminum with powder coat finish to resist corrosion. 2-3/8" seat mounts are functional, dependable, and easy to use.

2-3/8" Pedestals include: Mainstay, Explorer, and Clipper series. Available in a variety of lengths and finishes to meet your boat's style and everyday needs.



PEDESTAL PACKAGES • SEAT MOUNTS • SLIDES AND SWIVELS • PEDESTALS

2-3/8" Series

Regular Mainstay Packages

Retail					
Image	Part Number	Adjusts	Seat Mount	Pack Quantity	ABYC
B.	1250100-L1	14" to 20"	3100031-LAR1	1 Retail	AP
C.	1250150-L1	14" to 20"	3100531-LAR1	1 Retail	AD

OEM					
Image	Part Number	Adjusts	Seat Mount	Pack Quantity	ABYC
A.	1250100	14" to 20"	3100031-AR1	1 OEM	AP
B.	1250100-L	14" to 20"	3100031-LAR1	1 OEM	AD
C.	1250150-L	14" to 20"	3100531-LAR1	1 OEM	AD

Retail packed in box with 4 color label

- 2-3/8" pedestal with 9" round base, and anodized finish.
- Air-powered height adjustment from 14" to 20"
- Available with locking or non-locking Trac-Lock™ swivel or slide & swivel.

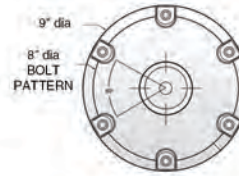

Mainstay Packages Are Rated
ABYC Class H-31 AD & AP



Non-Locking Swivel



Locking Swivel



Locking
Slide & Swivel

Short Mainstay Packages

Retail					
Image	Part Number	Adjusts	Seat Mount	Pack Quantity	ABYC
A.	1250200-L1	12-5/8" to 15-5/8"	3100031-LAR1	1 Retail	AD
B.	1250250-L1	12-1/2" to 15-1/2"	3100531-LAR1	1 Retail	AD

OEM					
Image	Part Number	Adjusts	Seat Mount	Pack Quantity	ABYC
A.	1250200-L	12-5/8" to 15-5/8"	3100031-LAR1	1 OEM	AD
A.	1250206-L	9-1/2" to 11-1/2"	3100031-LAR1	1 OEM	AD
B.	1250250-L	12-1/2" to 15-1/2"	3100531-LAR1	1 OEM	AD
C.	1250250-LC	12-1/2" to 15-1/2"	3100531-LAR1	1 OEM	AD
B.	1250256-L	10" to 12"	3100531-LAR1	1 OEM	AD

Retail packed in box with 4 color label

- 2-3/8" pedestal with 9" round base, and anodized finish.
- Air-powered height adjustment.
- Available with locking Trac-Lock™ swivel or slide & swivel.

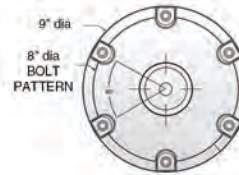

Short Mainstay Packages Are
Rated ABYC Class H-31 AD



Locking Swivel



Locking Slide & Swivel



Locking Collar

2-3/8" Series

Thru-Deck Packages

Retail					
Image	Part Number	Adjusts	Seat Mount	Pack Quantity	ABYC
A.	1250252-L	9" to 12"	3100531-LAR1	1 Retail	AD
B.	1250252-LC	9" to 12"	3100531-LAR1	1 Retail	AD
A.	1250253-L	8-3/4" to 14-1/2"	3100531-LAR1	1 Retail	AD
C.	1250254-L	8-1/4" to 14"	3100031-LAR1	1 Retail	AD
D.	1250260-L	5-3/8" to 8-3/8"	3100531-LAR1	1 Retail	AD

Retail packed in box with 4 color label

- 2-3/8" pedestal with 9" round base, anodized finish.
- Thru-Deck pedestals require a 3-3/4" hole in deck.
- Air-powered height adjustment.
- Available with locking Trac-Lock™ swivel or slide & swivel.

(A, B, & D.)

Includes Trac-Lock™ slide & swivel

(C. Not Shown)

Includes Trac-Lock™ swivel only



Thru-Deck Packages Are Rated ABYC Class H-31 AD



Dual Mainstay Pedestals & Swivels

Retail				
Image	Part Number	Description	Pack Quantity	ABYC
A.	1250400	Dual Pedestals Only	2 Pack	AD
B.	1250401	Dual Swivels with Slide Handle Activator	2 Pack	AD

- 2-3/8" pedestal with 9" round base, anodized finish.
- Air-powered height adjustment from 13-1/4" to 19-1/4".
- 200 Newton gas cylinders provide even adjustment.
- Slide handle activates both cylinders simultaneously.

- Dual pedestals and dual swivels sold separately.
- Swivel adds 3/4" to height of pedestals.



Dual Mainstay Items Are Rated ABYC Class H-31 AD



Manual Explorer Adjustable Packages

Retail					
Image	Part Number	Adjusts	Seat Mount	Pack Quantity	ABYC
B.	1253032-L1	13-5/8" to 16-5/8"	3100031-L1	1 Retail	AD

OEM					
Image	Part Number	Adjusts	Seat Mount	Pack Quantity	ABYC
A.	1253031-L	13-7/8" to 16-7/8"	3100531-L1	5 Bulk	AD
B.	1253032-L	13-5/8" to 16-5/8"	3100031-L1	5 Bulk	AD
C.	1253031-MNS	12-1/2" to 15-1/2"	Not Included	5 Bulk	AD

Retail packed in box with 4 color label

- 2-3/8" adjustable pedestal with 9" round base
- Pedestal adjusts in 1 inch increments.
- Anodized post with satin base.
- Available with locking Trac-Lock™ swivel or slide & swivel.



Explorer Packages Are Rated ABYC Class H-31 AD



Explorer Fixed Height Packages

Retail					
Image	Part Number	Fixed Height	Seat Mount	Pack Quantity	ABYC
A.	1250309	9"	3100031-1	1 Retail	AP
B.	1250309-L	9"	3100031-L1	1 Retail	AD
A.	1250312	12"	3100031-1	1 Retail	AP
B.	1250312-L	12"	3100031-L1	1 Retail	AD
B.	1250313-L	13"	3100031-L1	1 Retail	AD
A.	1250315	15"	3100031-1	1 Retail	AP
B.	1250315-L	15"	3100031-L1	1 Retail	AD
C.	1250349-L	9"	3100531-L1	1 Retail	AD
C.	1250351-L	11"	3100531-L1	1 Retail	AD
C.	1250353-L	13"	3100531-L1	1 Retail	AD

Retail packed in box with 4 color label

- 2-3/8" pedestal with 9" round base.
- Anodized fixed height post, with die cast satin base.
- Available with locking or non-locking Trac-Lock™ swivel or slide & swivel.

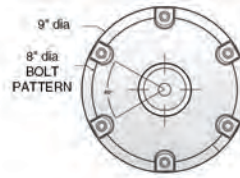

Mainstay Packages Are Rated
ABYC Class H-31 AD & AP



Clipper Adjustable Package

Retail					
Image	Part Number	Adjusts	Seat Mount	Pack Quantity	ABYC
A.	1440334	13" to 18"	3100031-1	1 Retail	B

Retail packed in box with 4 color label

- 2-3/8" adjustable pedestal with 10" round base.
- Adjusts 13" to 18" in 1 inch increments.
- Anodized finish.
- Includes non-locking Trac-Lock™ swivel.



Clipper Packages Are Rated
ABYC Class H-31 B



Clipper Fixed Height Packages

Retail					
Image	Part Number	Fixed Height	Seat Mount	Pack Quantity	ABYC
A.	1440213	9"	3100031-1	1 Retail	AP
B.	1440213-L	9"	3100031-L1	1 Retail	AD
A.	1440220	12"	3100031-1	1 Retail	AP
B.	1440220-L	12"	3100031-L1	1 Retail	AD
A.	1440228	15"	3100031-1	1 Retail	AP

Retail packed in box with 4 color label

- 2-3/8" pedestal with 10" round base.
- Polished fixed height post, with satin base.
- Available with locking or non-locking Trac-Lock™ swivel.



Clipper Packages Are Rated
ABYC Class H-31 AD & AP

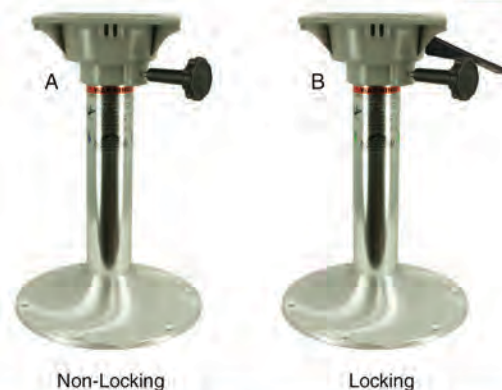

2-3/8" Series

Trac-Lock™ Swivels

Retail				
Image	Part Number	Description	Pack Quantity	ABYC
A.	1100031-1	Non-Locking Swivel	6 Retail	AP
B.	1100031-L1	Locking Swivel	6 Retail	AD

OEM				
Image	Part Number	Description	Pack Quantity	ABYC
A.	3100031-1	Non-Locking Swivel	20 Bulk	AP
B.	3100031-L1	Locking Swivel	20 Bulk	AD
C.	3100031-LAR1	Locking Air-Ride Swivel	20 Bulk	AD

Retail packages are packed in clamshell with 4 color label

2-3/8" post mount with bushing for snug fit.
 Made of high-strength aluminum with powder coat finish.
 Available as Air-Ride, locking, or non-locking.
 Centrally located locking handle, easy to reach with left or right hand. Swivel rotates 360°, and adds 3/4" to height of pedestal.

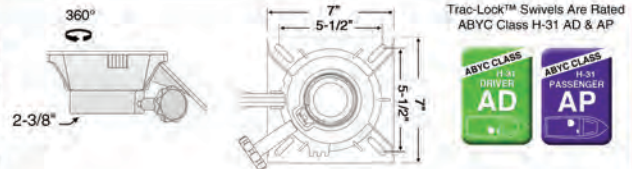

Non-Locking



Locking



Locking Air-Ride

Trac-Lock™ Slides & Swivels

Retail				
Image	Part Number	Description	Pack Quantity	ABYC
A.	1100531-1	Non-Locking Slide & Swivel	6 Retail	AP
B.	1100531-L1	Locking Slide & Swivel	6 Retail	AD

OEM				
Image	Part Number	Description	Pack Quantity	ABYC
A.	3100531-1	Non-Locking Slide & Swivel	10 Bulk	AP
B.	3100531-L1	Locking Slide & Swivel	10 Bulk	AD
C.	3100531-LAR1	Locking Air-Ride Slide & Swivel	10 Bulk	AD

Retail packages are packed in clamshell with 4 color label

High-strength aluminum slide & swivel, rotates 360°. Large 7-1/4" x 13" seat mounting platform, travels 5-1/4" forward and backward on self-lubricating pads. Centrally located locking handle, easy to reach with left or right hand. Adds 1-1/4" to height of pedestal.

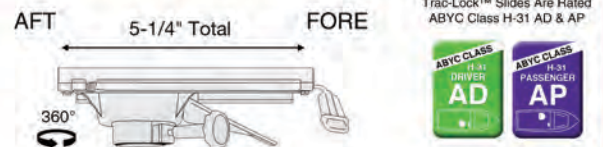

Non-Locking



Locking



Locking Air-Ride

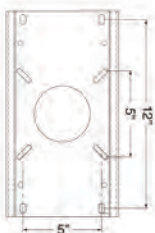

Explorer Fixed Height Pedestals

Retail					
Image	Part Number	Height	Locking / Non-Locking	Pack Quantity	ABYC
A.	1250309-LNS	9"	Locking	1 Retail	AD
B.	1250309-NS	9"	Non-Locking	1 Retail	AP
A.	1250310-LNS	10"	Locking	1 Retail	AD
A.	1250312-LNS	12"	Locking	1 Retail	AD
A.	1250313-LNS	13"	Locking	1 Retail	AD
A.	1250315-LNS	14"	Locking	1 Retail	AD

OEM					
Image	Part Number	Height	Locking / Non-Locking	Pack Quantity	ABYC
A.	1250307-MLNS	7"	Locking	5 Bulk	AD
A.	1250308-MLNS	8"	Locking	5 Bulk	AD
A.	1250309-MLNS	9"	Locking	5 Bulk	AD
A.	1250310-MLNS	10"	Locking	5 Bulk	AD
A.	1250311-MLNS	11"	Locking	5 Bulk	AD
A.	1250312-MLNS	12"	Locking	5 Bulk	AD

Retail packed in box with 4 color label

2-3/8" pedestal with 9" round base.
Anodized aluminum post, with die cast satin base.
Use with Trac-Lock™ slide or swivel (sold separately).

Available in a variety of heights.

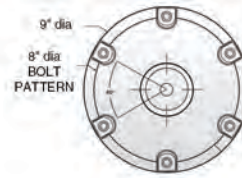

Explorer Pedestals Are Rated
ABYC Class H-31 AD & AP



Clipper Fixed Height Pedestals

Retail					
Image	Part Number	Height	Post Finish	Pack Quantity	ABYC
A.	1440007-SAL	7"	Anodized Finish	1 Retail	AD
A.	1440013-SAL	13"	Anodized Finish	1 Retail	AD
A.	1440015-SAL	15"	Anodized Finish	1 Retail	AD

OEM					
Image	Part Number	Height	Post Finish	Pack Quantity	ABYC
B.	1440010-DSL	10"	Polished/Satin Finish	2 Bulk	AD
A.	1440607-MAL	7"	Anodized Finish	5 Bulk	AD
A.	1440609-MAL	9"	Anodized Finish	5 Bulk	AD
A.	1440610-MAL	10"	Anodized Finish	5 Bulk	AD
A.	1440612-MAL	12"	Anodized Finish	5 Bulk	AD
A.	1440613-MAL	13"	Anodized Finish	5 Bulk	AD
A.	1440615-MAL	15"	Anodized Finish	5 Bulk	AD

Retail packed in box with 4 color label

2-3/8" pedestal with 10" round base and 9" mounting pattern.
Use with locking Trac-Lock™ slide or swivel (sold separately).

Available in a variety of heights.

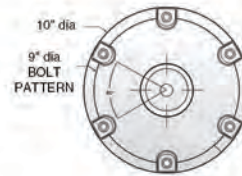

Clipper Pedestals Are Rated
ABYC Class H-31 AD

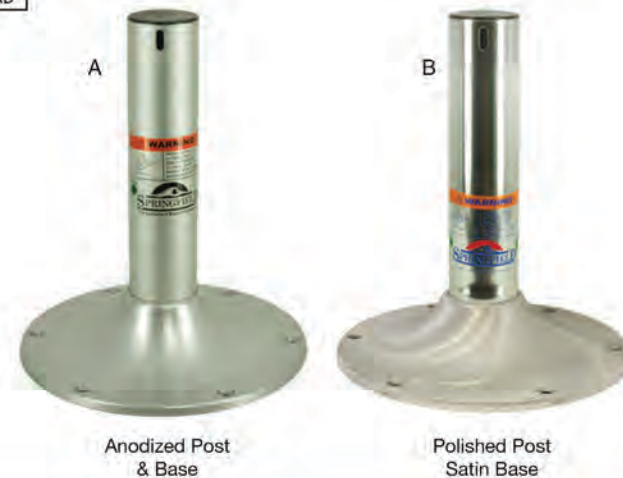

2-7/8" Series

ABOUT 2-7/8" SERIES

2-7/8" Seat Mounts include: The Trac-Lock™, Prestige, Camlock, and Elite series. Made from high-strength aluminum with powder coat finish to resist corrosion.

2-7/8" Pedestals include: Mainstay, Second Generation, Elite, Schooner, and Regatta series. Available in a variety of lengths and finishes to meet your boat's style and everyday needs.



TRAC-LOCK™ • PRESTIGE • CAMLOCK • ELITE • MAINSTAY • SECOND GENERATION • REGATTA



2-7/8" Series

Heavy-Duty Mainstay Packages

Retail						
Image	Part Number	Adjusts	Seat Mount	Base Size	Pack Quantity	ABYC
A.	1250300	13" to 18"	3100021-LAR1	9"	1 OEM	AD
B.	1250301	14-1/2" to 20"	3100521-LAR1	9"	1 OEM	AD
B.	1250450-L	12-1/2" to 15-1/2"	3100521-LAR1	9"	1 OEM	AD
B.	1250456-L	10" to 12"	3100521-LAR1	9"	1 OEM	AD
C.	1250470-LC	12-1/2" to 15-1/2"	3101521-LARW	9"	1 OEM	AD
D.	1250321	14-1/2" to 20"	3100521-LAR1	12"	1 OEM	AD
E.	1250356-LC2	10" to 12"	3100521-LAR1	12"	1 OEM	AD

- 2-7/8" pedestal with 9" or 12" round base.
- Rigid 4 keyed aluminum post, anodized finish.
- Air-powered height adjustment.
- Available with locking Trac-Lock™ swivel or slide & swivel.

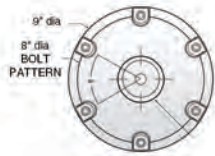

Extra Wide Seat Mount & Locking Collar



Swivel Only



Slide & Swivel



Slide & Swivel
12" Base



Slide & Swivel
Tension Handle

Mainstay Packages Are Rated ABYC Class H-31 AD



Second Generation Packages

Retail						
Image	Part Number	Height	Seat Mount	Pack Quantity	ABYC	
B.	1240609-L	9"	3100021-L1	1 Retail	AD	
A.	1240616	12"	3100021-1	1 Retail	AP	
B.	1240616-L	12"	3100021-L1	1 Retail	AD	
C.	1240716-L	12"	3100521-L1	1 Retail	AD	
A.	1240629	18"	3100021-1	1 Retail	AP	
B.	1240629-L	18"	3100021-L1	1 Retail	AD	
C.	1240729-L	18"	3100521-L1	1 Retail	AD	
C.	1240720-L	20"	3100521-L1	1 Retail	AD	
A.	1240639	24"	3100021-1	1 Retail	AP	
C.	1240739-L	24"	3100521-L1	1 Retail	AD	

Retail packed in box with 4 color label

- 2-7/8" pedestal with 9" round base.
- High-strength anodized aluminum.
- Available in a variety of heights.
- Available with locking or non-locking Trac-Lock™ swivel or slide & swivel.

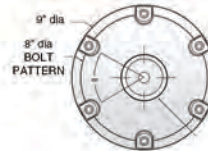

Swivel Only
Non-Locking



Swivel Only
Locking



Slide & Swivel
Locking

Second Generation Packages Are Rated ABYC Class H-31 AD & AP



Explorer Packages

Retail						
Image	Part Number	Height	Seat Mount	Pack Quantity	ABYC	
A.	1250533	10"	3100021-1	1 Retail	AP	
A.	1250535	12"	3100021-1	1 Retail	AP	
B.	1250535-L	12"	3100021-L1	1 Retail	AD	
A.	1250540	18"	3100021-1	1 Retail	AP	
B.	1250540-L	18"	3100021-L1	1 Retail	AD	
B.	1250545-L	24"	3100021-L1	1 Retail	AD	
A.	1250550	30"	3100021-1	1 Retail	AP	
B.	1250550-L	30"	3100021-L1	1 Retail	AD	

Retail packed in box with 4 color label

- 2-7/8" high-strength anodized aluminum post.
- Available in a variety of heights.
- Available with locking or non-locking Trac-Lock™ swivel.



Non-Locking



Locking

Explorer Packages Are Rated ABYC Class H-31 AD & AP



2-7/8" Series

Camlock Pedestal Units

Retail					
Image	Part Number	Height	Seat Mount	Pack Quantity	ABYC
A.	1260012	12"	3100930-A1	1 Retail	AD
B.	1260018	18"	3100930-A1	1 Retail	AD
C.	1260024	24"	3100930-A1	1 Retail	AD

Retail packed in box with 4 color label

- 2-7/8" Camlock slide & swivel with pedestal.
- Large 7-1/4" x 13" mounting platform.
- High-strength anodized aluminum.
- Seat mount rotates 360° and travels 6" forward and backward.
- One handle operates slide as well as swivel.



Camlock Packages Are Rated
ABYC Class H-31 AD



2-7/8" Camlock Slide & Swivel

Retail				
Image	Part Number	Description	Pack Quantity	ABYC
A.	1100930-A1	Slide & Swivel With Telescoping Handle	1 Retail	AD

OEM				
Image	Part Number	Description	Pack Quantity	ABYC
A.	3100930-A1	Slide & Swivel With Telescoping Handle	10 Bulk	AD

High-strength aluminum, large 7-1/4" x 13" platform with 5" x 5" & 5" x 12" mounting pattern. Travels 6" forward and backward on self-lubricating pads. Automatically locks in forward position. Dual function activator handle operates slide as well as swivel, rotates 360°. Handle telescopes up to 3". Adds 1-1/2" to height of pedestal.

Patent #5,704,729

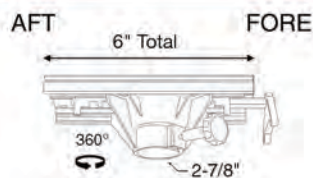
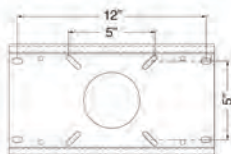

Camlock Slides Are Rated
ABYC Class H-31 AD



Trac-Lock™ Swivels

Retail				
Image	Part Number	Description	Pack Quantity	ABYC
A.	1100021-1	Non-Locking Swivel	6 Retail	AP
B.	1100021-L1	Locking Swivel	6 Retail	AD

OEM				
Image	Part Number	Description	Pack Quantity	ABYC
A.	3100021-1	Non-Locking Swivel	20 Bulk	AP
B.	3100021-L1	Locking Swivel	20 Bulk	AD
C.	3100021-CR1	Non-Locking Chrome Swivel	1 OEM	AP
D.	3100021-LAR1	Locking Air-Ride Swivel	20 Bulk	AD

Retail packages are packed in clamshell with 4 color label

2-7/8" post mount with bushing for snug fit. Made of high-strength aluminum with powder coat finish. Rotates 360°. Available as air-ride locking, or non-locking. Centrally located locking handle, easy to reach with left or right hand.

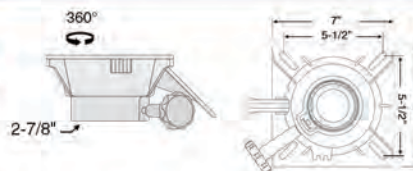

Trac-Lock™ Swivels Are Rated
ABYC Class H-31 AD & AP



Trac-Lock™ Slides

Retail				
Image	Part Number	Description	Pack Quantity	ABYC
A.	1100521-1	Non-Locking Slide & Swivel	6 Retail	AP
B.	1100521-L1	Locking Slide & Swivel	6 Retail	AD

OEM				
Image	Part Number	Description	Pack Quantity	ABYC
A.	3100521-1	Non-Locking Slide & Swivel	10 Bulk	AP
C.	3100521-CL1	Cable Activated Slide & Swivel	10 Bulk	AD
B.	3100521-L1	Locking Slide & Swivel	10 Bulk	AD
D.	3100521-LAR1	Locking Air-Ride Slide & Swivel	10 Bulk	AD
E.	3100521-LE1	Locking Extended Slide Handle	10 Bulk	AD
F.	3100521-LL1	Left Locking Swivel Handle	10 Bulk	AD
G.	3100521-LLL1	Left Locking Controls	10 Bulk	AD
H.	3100521-EL1	Electric Slide & Swivel	10 Bulk	AD

Retail packages are packed in clamshell with 4 color label

High-strength aluminum. Large 7-1/4" x 13" seat mounting platform, travels 5-1/4" forward and backward on self-lubricating pads. Centrally located locking handle, easy to reach with left or right hand. Rotates 360°. Available as air-ride, locking, or non-locking slides & swivels. Adds 1-1/4" to height of pedestal.

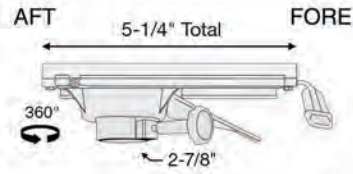
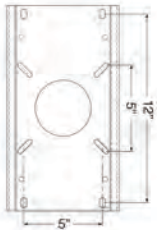

Trac-Lock™ Slides Are Rated
ABYC Class H-31 AD & AP



Prestige Slides

OEM				
Image	Part Number	Description	Pack Quantity	ABYC
A.	3101521-L	Locking Slide & Swivel	10 Bulk	AD
B.	3101521-GLAR	Air-Ride, Gas Assisted Slide	10 Bulk	AD
C.	3101521-LAR	Air-Ride Slide & Swivel	10 Bulk	AD
D.	3101521-LARW	Air-Ride Slide & Swivel, Extra Wide Plate	10 Bulk	AD
E.	3101521-LC	Cable Operated Slide	10 Bulk	AD
F.	3101521-LW	Slide & Swivel, Extra Wide Plate	10 Bulk	AD

2-7/8" locking Prestige slides & swivels.
Large 8" x 13" seat mount platform (extra wide: 14" x 13")
travels 6-3/8" forward and backwards. Easy to reach handles.
Adds 1-1/4" to height of pedestal.

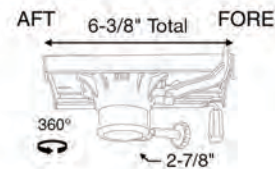
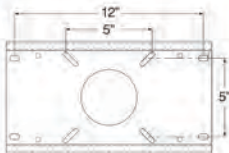

Prestige Slides Are Rated
ABYC Class H-31 AD



2-7/8" Series

2-7/8" Series

Mainstay Adjustable Pedestals

Mainstay Pedestals Are Rated
ABYC Class H-31 AD

Retail					
Image	Part Number	Adjusts	Base Size	Pack Quantity	ABYC
A.	1250321-NS	13-1/4" to 19"	12"	1 Retail	AD
B.	1250326-NS	16-1/2" to 23"	12"	1 Retail	AD
C.	1250328-NS	24" to 30-1/2"	12"	1 Retail	AD

Retail packages are packed in box with 4 color label

2-7/8" pedestal with 12" round base, anodized finish.
Rigid keyed aluminum post. Air-powered height adjustment.
Use with any 2-7/8" air-ride slides or swivels (sold separately).

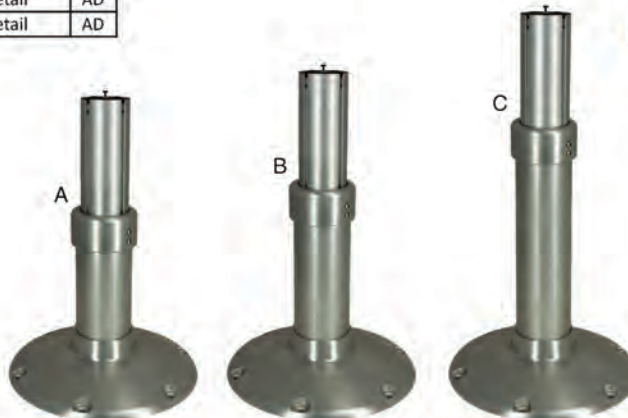

Second Generation Adjustable Pedestal

Adjustable Pedestals Are Rated
ABYC Class H-31 AD

Retail					
Image	Part Number	Adjusts	Finish	Pack Quantity	ABYC
B.	1240749-LNS	14-3/8" to 20-3/8"	Anodized	1 Pack	AD
C.	1240750-LNS	17-1/4" to 23-1/4"	Anodized	1 Pack	AD

OEM					
Image	Part Number	Adjusts	Finish	Pack Quantity	ABYC
A.	1240748-MLNS	11-7/8" to 14-3/4"	Anodized	5 Bulk	AD
B.	1240749-MLNS	14-3/8" to 20-3/8"	Anodized	5 Bulk	AD
C.	1240750-MLNS	17-1/4" to 23-1/4"	Anodized	5 Bulk	AD
D.	1240752-MLNS	20" to 26"	Anodized	5 Bulk	AD

Retail packages are packed in box with 4 color label

2-3/8" inner post with 2-7/8" locking adapter, 9" round base. Adjusts in 1 inch increments. Anodized post and base.
Use with 2-7/8" Trac-Lock™ slide or swivel (sold separately).



Stainless Steel Fixed Height Pedestals

SS Fixed Height Pedestals Are
Rated ABYC Class H-31 AD

Retail					
Image	Part Number	Height	Material	Pack Quantity	ABYC
A.	1280618-SS	18"	316 Stainless Steel	1 Pack	AD
B.	1280624-SS	24"	316 Stainless Steel	1 Pack	AD

Polished cast 9" round stainless steel base, welded to post for maximum strength. 2-7/8" post with heavy-duty thick wall construction. 316 grade stainless steel with #8 mirror finish.

Available in a variety of heights
Use with any 2-7/8" Trac-Lock™ locking slide or swivel (sold separately)



Second Generation Fixed Height Pedestals

Image:	A.	
Height:	Anodized	Pack QTY
6"	1240006-SAL	1 Pack
8"	1240008-SAL	1 Pack
10"	1240010-SAL	1 Pack
12"	1240012-SAL	1 Pack
15"	1240015-SAL	1 Pack
18"	1240018-SAL	1 Pack
20"	1240020-SAL	1 Pack
24"	1240024-SAL	1 Pack

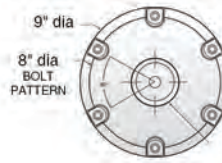

Second Gen Pedestals Are Rated ABYC Class H-31 AD



Image:	A.	B.	C.	
Height:	Anodized	Polished	Satin	Pack QTY
6"	1240006-DAL	1240006-DPL	1240006-DSL	2 Bulk
9"	1240009-DAL	-	-	2 Bulk
12"	1240012-DAL	1240012-DPL	1240012-DSL	2 Bulk
14"	1240014-DAL	1240014-DPL	1240014-DSL	2 Bulk
18"	1240018-DAL	1240018-DPL	1240018-DSL	2 Bulk
20"	1240020-DAL	1240020-DPL	1240020-DSL	2 Bulk
24"	1240024-DAL	1240024-DPL	1240024-DSL	2 Bulk



Anodized Base



Polished Base

Image:	A.	B.	C.	D.	
Height:	Anodized	Polished	Satin	Fluted	Pack QTY
6"	1240006-MAL	1240006-MPL	1240006-MSL	-	5 Bulk
7"	1240007-MAL	-	-	-	5 Bulk
8"	1240008-MAL	-	1240008-MSL	-	5 Bulk
9"	1240009-MAL	-	-	1240509-MAL	5 Bulk
10"	1240010-MAL	-	1240010-MSL	-	5 Bulk
11"	1240011-MAL	-	-	-	5 Bulk
12"	1240012-MAL	1240012-MPL	1240012-MSL	1240512-MAL	5 Bulk
14"	1240014-MAL	1240014-MPL	1240014-MSL	-	5 Bulk
18"	1240018-MAL	1240018-MPL	1240018-MSL	-	5 Bulk
20"	1240020-MAL	1240020-MPL	1240020-MSL	-	5 Bulk
24"	1240024-MAL	1240024-MPL	1240024-MSL	-	5 Bulk
6"	-	1240206-MPL	-	-	5 Bulk



Satin Base



Fluted Post Anodized Base

2-7/8" aluminum pedestals with 9" round floor base.
Bases available as anodized, polished, or satin.
Use with locking Trac-Lock™ slide or swivel (sold separately).

Permanent mold base is made from high magnesium content aluminum for corrosion resistance.

Additional sizes and non-locking pedestals available upon request.

Explorer Fixed Height Pedestals

OEM					
Image	Part Number	Height	Locking / Non-Locking	Pack Quantity	ABYC
A.	1250534-MLNS	10"	Locking	5 Bulk	AD
B.	1250535-MLNS	12"	Locking	5 Bulk	AD

Explorer Pedestals Are Rated ABYC Class H-31 AD



2-7/8" anodized aluminum locking pedestal with 9" round satin base.

Use with any 2-7/8" locking Trac-Lock™ slide or swivels (sold separately).

Bases are made from high magnesium content aluminum for corrosion resistance.



2-7/8" Series

Schooner Pedestals With Flat-Side

Image	A.	B.		
Height	Anodized	Satin	Pack Quantity	ABYC
6"	1260606-DAL	1260606-DSL	2 Bulk	AD
7"	1260607-MAL	-	5 Bulk	AD
8"	1260608-DAL	1260608-DSL	2 Bulk	AD
10"	1260610-DAL	1260610-DSL	2 Bulk	AD
12"	1260612-DAL	1260612-DSL	2 Bulk	AD
15"	1260615-DAL	1260615-DSL	2 Bulk	AD

Schooner Pedestals Are Rated ABYC Class H-31 AD



2-7/8" locking pedestal with 9" flat-side base combination. Available with satin or anodized base. Use with 2-7/8" locking Trac-Lock™ slide or swivel (sold separately).

Base is made from high magnesium content aluminum for corrosion resistance.



Anodized Base



Satin Base

Regatta Pedestals

Image:	A.	B.	C.		
Height:	Anodized	Fluted	Polished	Pack QTY	ABYC
4.5"	1280104-SAL	-	-	1 Pack	AD
6"	1280106-SAL	-	-	1 Pack	AD

Regatta Pedestals Are Rated ABYC Class H-31 AD



Image:	A.	B.	C.		
Height:	Anodized	Fluted	Polished	Pack QTY	ABYC
4.5"	1280104-MAL	1280104-MALC	1280104-MPL	2 Bulk	AD
6"	1280106-MAL	-	1280106-MPL	2 Bulk	AD
7"	1280107-MAL	1280107-MALC	-	2 Bulk	AD
8"	1280108-MAL	1280108-MALC	1280108-MPL	2 Bulk	AD
9"	1280109-MAL	1280109-MALC	-	2 Bulk	AD
10"	1280110-MAL	1280110-MALC	-	2 Bulk	AD
11"	1280111-MALW	-	-	2 Bulk	AD

2-7/8" locking pedestal with 9" low-profile base combination. For use with any 2-7/8" locking Springfield Marine slide or swivel (sold separately).

Permanent mold base is made from high magnesium content aluminum for corrosion resistance.

MALW: Post is welded to base for maximum strength.



Anodized Finish

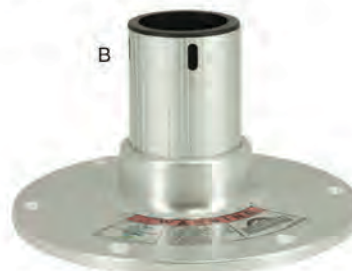

Fluted Anodized Finish



Polished Finish

ABOUT 4" SERIES

For the most demanding work or pleasure boat applications, Springfield Marnie's heavy-duty 4" Series is designed for rugged service and wobble free control.

4" Seat Mounts include: The Mariner & Mariner II, Workhorse, and Elite Series. The seating hardware of choice for the most extreme conditions.

4" Pedestals include: The Mainstay and Elite series. Available as Fixed height, or Adjustable Pedestals, in a variety of lengths and finishes. Corrosion resistant stainless steel or high-strength aluminum.



4" Series

MARNIE • MARINER • MARINER II • WORKHORSE • ELITE • MAINSTAY



4" Series

Mainstay Electric Pedestal Packages

Retail					
Image	Part Number	Description	Adjusts	Pack Quantity	ABYC
A.	1271340-PE	Aluminum Pedestal Package	17-1/4" to 22"	1 Retail	AD
A.	1271349-PE	Aluminum Pedestal Package	24-1/4" to 32"	1 Retail	AD
B.	1271640-SSE	Stainless Steel Pedestal Package	17-1/4" to 22"	1 Retail	AD
B.	1271649-SSE	Stainless Steel Pedestal Package	24-1/4" to 32"	1 Retail	AD
C.	1271333-PE	Thru-Deck Pedestal Package	14" to 18"	1 Retail	AD
C.	1271334-PE	Thru-Deck Pedestal Package	18" to 26"	1 Retail	AD

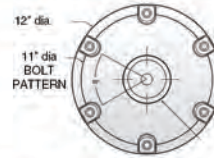

Electric Pedestals Are Rated ABYC Class H-31 AD



Electric pedestals require 12 volt DC / 14 amp power.

Package Includes:

- Electric Pedestal
- Mariner II 3100565-LAE Slide & Swivel
- Switches & Switch Box

4" diameter outer post, 3-1/2" inner post with 4" collar. 12" base with 11" hole pattern.
Electric powered height adjustment. Lifts 500 lbs.
Thick wall construction for maximum durability.

(A. & C.) Made from high-strength aluminum.

(B.) Made from 316 #8 mirror finish stainless steel.



Mariner II Slides & Swivels

OEM					
Image	Part Number	Description	Finish	Pack Quantity	ABYC
A.	3100565-L	Locking Slide & Swivel	Black	1 Pack	AD
A.	3100565-LA	Locking Slide & Swivel	Anodized	1 Pack	AD
B.	3100565-LAET	Electric Slide With Swivel	Anodized	1 Pack	AD
C.	3100565-LAR	Air-Ride Slide & Swivel	Black	1 Pack	AD
C.	3100565-LARA	Air-Ride Slide & Swivel	Anodized	1 Pack	AD
C.	3100565-LARW	Air-Ride Slide & Swivel	White	1 Pack	AD
A.	3100565-LW	Locking Slide & Swivel	White	1 Pack	AD

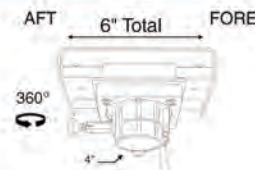

Mariner Slides & Swivels Are Rated ABYC Class H-31 AD



10-1/2" x 14-1/2" x 1/4" aluminum formed slide plate.
Swivel clamps and locks onto a 4" post with stainless steel pin and rotates internally on 1/2" HDPE bearing for smooth operation in any position. Travels 6" fore and aft.

Mariner II slides & swivels are available as air-ride, or electric. Adds 3-7/8" to height of pedestal.



Mariner II Swivels

OEM					
Image	Part Number	Description	Finish	Pack Quantity	ABYC
A.	3100065-L	Mariner II Locking Swivel	Anodized	1 Pack	AD
B.	3100065-LAR	Mariner II Locking Air-Ride Swivel	Anodized	1 Pack	AD

Mariner Slides & Swivels Are Rated ABYC Class H-31 AD



Large high strength aluminum mounting plate.
Swivel clamps and locks onto a 4" post with stainless steel pin and rotates internally on 1/2" HDPE bearing for smooth operation in any position.

Mariner II swivels are available as locking, and locking air-ride swivels.

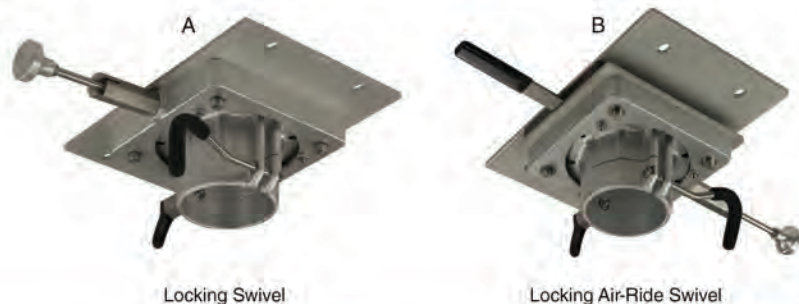

Workhorse Slide & Swivels

OEM					
Image	Part Number	Description	Finish	Pack Quantity	ABYC
A.	3100075-L	Swivel Only	Anodized	1 Pack	AD
B.	3100075-LAR	Air-Ride Swivel Only	Anodized	1 Pack	AD
C.	3100575-L	Slide & Swivel	Anodized	1 Pack	AD
D.	3100575-LAR	Air-Ride Slide & Swivel	Anodized	1 Pack	AD
E.	3100575-LARW	Air-Ride Slide & Swivel	White	1 Pack	AD

10-1/4" x 14-1/2" x 1/4" aluminum formed slide plate.
Swivel locks and clamps tight to 4" post for rock solid performance. Heavy-duty stainless steel lock pin. Large easy to reach control knobs. Slide travels 6" fore and aft.

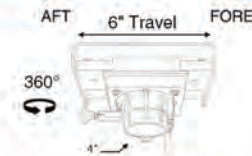

Workhorse Slides Are Rated ABYC Class H-31 AD

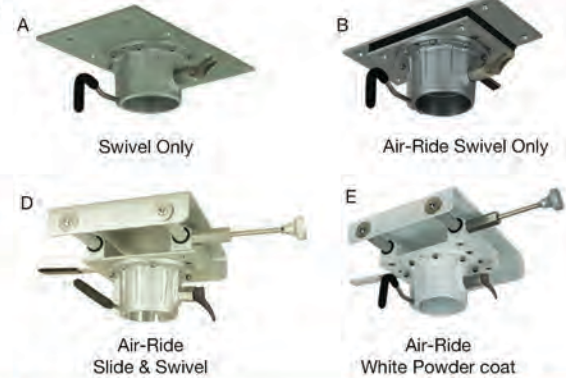

Elite Slide & Swivel

OEM					
Image	Part Number	Description	Finish	Pack Quantity	ABYC
A.	3100460-LE1	Elite Slide & Swivel	Anodized	4 Bulk	AD

8-1/4" x 13" seat mounting platform. Anodized slide and polished post mount, fits over 4" pedestals. Locks and tightens securely to prevent wobble. Large pivot area ensures stability, rotates 360°. Slide travels 5-3/8" fore and aft. Adds 1-1/2" to height of pedestal.

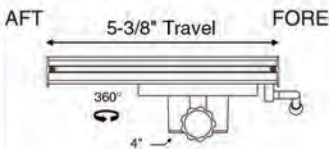

Elite Slides Are Rated ABYC Class H-31 AD



Mainstay Stainless Steel Adjustable Pedestals

Retail					
Image	Part Number	Adjusts	Material	Pack Quantity	ABYC
A.	1270640-SS	13-1/2" to 18"	316 Stainless Steel	1 Retail	AD
B.	1270646-SS	18" to 28"	316 Stainless Steel	1 Retail	AD
C.	1270650-SS	22" to 32"	316 Stainless Steel	1 Retail	AD
D.	1270676-SS	13" to 23"	316 Stainless Steel	1 Retail	AD

4" adjustable pedestal with 12" round base.
Air-powered height adjustment. 650 Newton air cylinder provides lift. 316 grade stainless steel with #8 mirror finish. Available in a variety of heights, and thru-deck options.



Mainstay Pedestals Are Rated ABYC Class H-31 AD

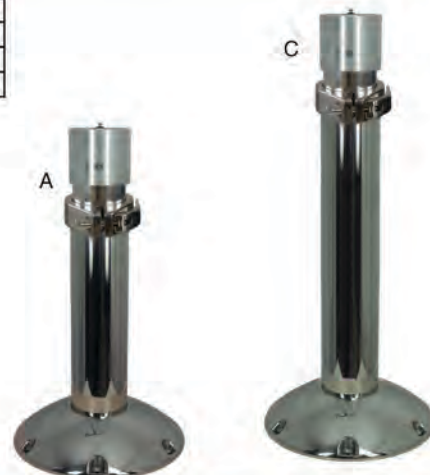

4" Series

Aluminum Adjustable Mainstay Pedestals

Retail					
Image	Part Number	Adjusts	Finish	Pack Quantity	ABYC
A.	1270340-P	13-1/2" to 18"	Polished Finish	1 Retail	AD
A.	1270346-P	18" to 28"	Polished Finish	1 Retail	AD
A.	1270350-P	22" to 32"	Polished Finish	1 Retail	AD
A.	1270354-P	26" to 36"	Polished Finish	1 Retail	AD
B.	1270370-W	6-3/8" to 14-1/4"	White Powder Coat	1 Retail	AD

4" adjustable pedestal with 12" round base. Air-powered height adjustment. 650 Newton air cylinder provides lift. Available as polished aluminum or white powder coat finish.

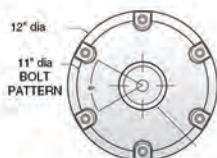

Polished Finish



White Powder Coat

Mainstay Pedestals Are Rated ABYC Class H-31 AD



Stainless Steel Fixed Height Pedestals

Retail					
Image	Part Number	Height	Material	Pack Quantity	ABYC
A.	1450615-SSP	15"	316 Stainless Steel	1 Retail	AD
B.	1450626-SSP	26"	316 Stainless Steel	1 Retail	AD
C.	1450630-SSP	30"	316 Stainless Steel	1 Retail	AD
D.	3100550-SS	3-3/4"	-	1 Retail	-

4" locking fixed height pedestal with 12" round base. 316 stainless steel, with #8 mirror finish. Rim welded to provide maximum strength. Available in a variety of heights.



A

B

C



Fixed Height Pedestals Are Rated ABYC Class H-31 AD



3100550-SS Center floor slide.

Allows seat to move easily up to 35-1/2" side-to-side between stations. Platform with pre drilled holes to accept standard 12" base.

Dimensions: 19" x 53.4" x 3.75"

Elite Fixed Height Pedestals

Retail					
Image	Part Number	Height	Finish	Pack Quantity	ABYC
A.	1450012-P	12"	Polished	1 Retail	AD
B.	1450014-P	14"	Polished	1 Retail	AD
C.	1450018-P	18"	Polished	1 Retail	AD
D.	1450022-P	22"	Polished	1 Retail	AD
E.	1450024-P	24"	Polished	1 Retail	AD
F.	1450028-P	28"	Polished	1 Retail	AD
G.	1450030-P	30"	Polished	1 Retail	AD

4" aluminum pedestal with 12" round base, polished finish. Pedestal is sized and pressed into base, then rim welded for stability.

• Posts are .213" thick aluminum.

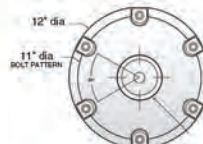

A

B

C

D

E

F

G



Elite Pedestals Are Rated ABYC Class H-31 AD



ABOUT WAVE DAMPENING

Wave dampening pedestals are designed to reduce the impact and vibration while fishing or cruising in rough waters. Shock absorbing mechanical springs with adjustable shock absorber allows progressively dampened travel to provide a smoother ride.



Wave Dampening

2-7/8" EZ-RIDE PEDESTAL • 4" EZ-RIDE PEDESTAL • SHOCKER PEDESTAL • AVENTO SYSTEMS



Wave Dampening

2-7/8" EZ-Ride Pedestal

Retail				
Image	Part Number	Description	Pack Quantity	ABYC
A.	1080136-L1	2-7/8" EZ-Ride Pedestal Package	1 Pack	AD

OEM				
Image	Part Number	Description	Pack Quantity	ABYC
B.	1080136	2-7/8" EZ-Ride Wave Dampening Pedestal	1 Pack	AD

Uses a gas shock inside a mechanical spring to provide non adjustable wave dampening and soft ride.

12" anodized aluminum pedestal with 9" round base, 3-1/2" outer post with 2-7/8" inner post and four grooves with keys to provide rotation lock and restrict movement collar covers bushing and inner post keys.

- Allows 3-1/2" of vertical travel
- Developed and intended for recreational inshore use
- Tested to ABYC H31 dynamic static loads



4" EZ-Ride Pedestal

Retail				
Image	Part Number	Description	Pack Quantity	ABYC
A.	1080117	4" EZ-Ride Wave Dampening Pedestal	1 Pack	AD
B.	1080115	4" EZ-Ride Thru-Deck Pedestal	1 Pack	AD

(A.) Proven mechanical spring and hydraulic shock technology in a traditional pedestal configuration.

- Thick wall (.213) posts.
- Allows 5-1/2" of vertical travel

(B.) Proven mechanical spring in a traditional pedestal configuration

- Polished brite dip aluminum pedestal with 12" round base
- Thick wall (.213) posts.
- Allows 5-1/2" of vertical travel

175lbs per inch rating.

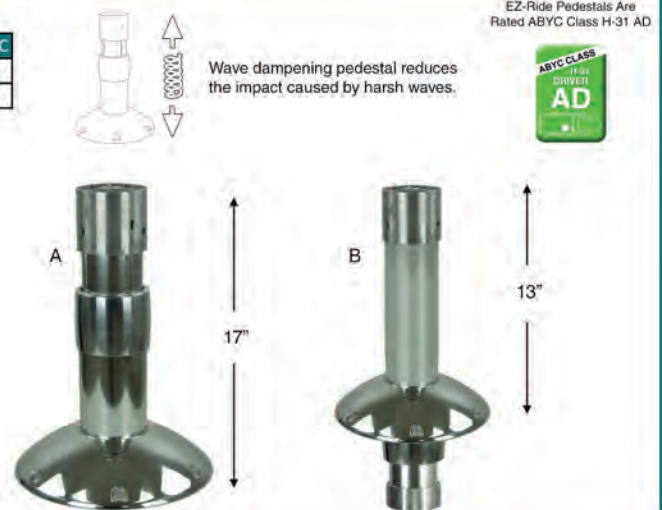

Shocker Pedestals

Retail				
Image	Part Number	Description	Pack Quantity	ABYC
A.	1080160	Shocker Pedestal, 1100 Pound Spring	1 Pack	AD
A.	1080165	Shocker Pedestal, 550 Pound Spring	1 Pack	AD

Uses proven mechanical spring and hydraulic shock technology. 1100 lb rated spring with adjustable flow shock absorber to control stiffness and dampening.

- Adjustable pitch control allows for softer or stiffer ride.
- Top plate has standard chair mounting pattern.
- Built in swivel rotates 360° and locks in 8 positions.
- Allows 4" of vertical travel

Wave dampening pedestal reduces the impact caused by harsh waves.

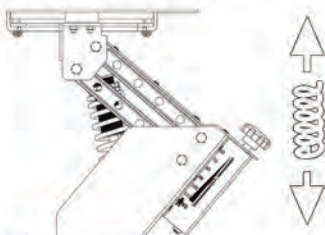

Avento Pro Air Package

OEM				
Image	Part Number	Description	Pack Quantity	ABYC
A.	1071542-PRO	Avento Pro Air Suspension & Seat Package	1 Pack	AD
B.	1071502-L	Avento Pro Seat Armrest - Left	1 Pack	-
C.	1071502-R	Avento Pro Seat Armrest - Right	1 Pack	-

The headrest pivots forward and backwards and adjusts 4" up or down. Armrests fold up or down with adjustable height and angle for easy access and support (sold separately)

High backrest is fitted with ergonomically molded cushions and extended sides for extra comfort

Backrest reclines from -10° to +70° in 2.5° increments and can be folded forward right onto the seat cushion

Electric adjustable Avento
Adjustable seat cushion reduces the pressure on the back of your knees. Adjustable in four steps in a 3° - 11° range



Avento Premium Seat & Package

OEM				
Image	Part Number	Description	Pack Quantity	ABYC
A.	1071590	Avento Premium Seat Package	1 Pack	AD
B.	1071524	Avento Premium Seat - Black & Charcoal	1 Pack	AD
C.	1071505-L	Avento Premium Seat Armrest - Left	1 Pack	-
D.	1071505-R	Avento Premium Seat Armrest - Right	1 Pack	-

The headrest pivots forward and backwards and adjusts 4" up or down. Armrests fold up or down with adjustable height and angle for easy access and support (sold separately)

Backrest reclines from -5° to +20° in 2.5° increments

- (A.) Avento Premium Package includes:
- Avento premium seat
 - Avento wave dampening suspension system
 - 2-7/8" Mainstay pedestal package with slide/swivel: 1250456-L

- (B.) Avento Premium Seat includes:
- Avento premium seat
 - Avento wave dampening suspension system



Wave Dampening Suspension System

OEM				
Image	Part Number	Description	Pack Quantity	ABYC
A.	1071500	Wave Dampening Suspension System	1 Pack	AD
B.	1580010	Suspension Seat Mount Adapter Plate	1 Pack	-

(A.) Full suspension technology allows 3.14" of wave dampening travel. Wave dampening system reduces the impact caused by harsh waves. Adjustable mechanical crank lever enables the seat to be adjusted for occupant's weight, ranging from 100 to 287 lbs.

(B.) Adapts Suspension System to Avento seats.



Adjustable crank handle allows you to pump the lever up or down to adjust the wave dampening suspension.



Mounting Systems

ABOUT MOUNTING SYSTEMS

Our wide range of Mounting Systems are designed for low profile decks with features that include both swivel and slide for passenger or driver's seat positions. Plus we offer a range of recreational systems for Jon Boats and other small crafts. ABYC H-31 A rated to B rated.

BENCH SLIDES • SWIVELS • SEAT CLAMPS • MOUNTING PLATES • SLIDE RAILS • PEDESTALS

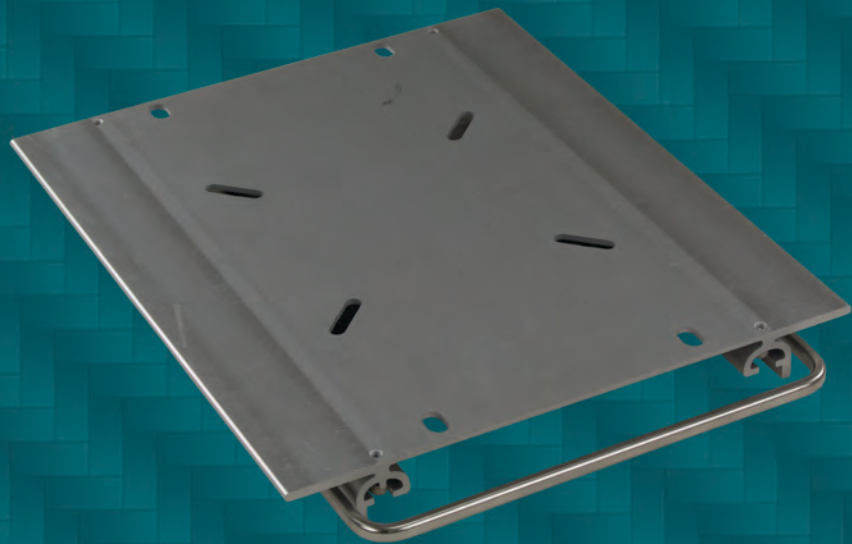

Tru-Lock 1000

Retail				
Image	Part Number	Description	Pack Quantity	ABYC
A.	1100360	Tru-Lock 1000 Slide & Swivel	1 Retail	AD

OEM				
Image	Part Number	Description	Pack Quantity	ABYC
A.	3100360	Tru-Lock 1000 Slide & Swivel	8 Bulk	AD
C.	3100360-EXTL	Tru-Lock 1000 Left Extended Handle	8 Bulk	AD

Retail packages are packed in box with 4 color label

Large 7-1/4" W x 13" D x 3-1/2" H platform. Travels 5-1/4" fore and aft with 8 locking positions. Large pivot area for stability. Rotates 360°, pivot handle rotates with chair. Easy to install and remove with separate lower mounting plate. 4" x 5-5/8" mounting pattern.

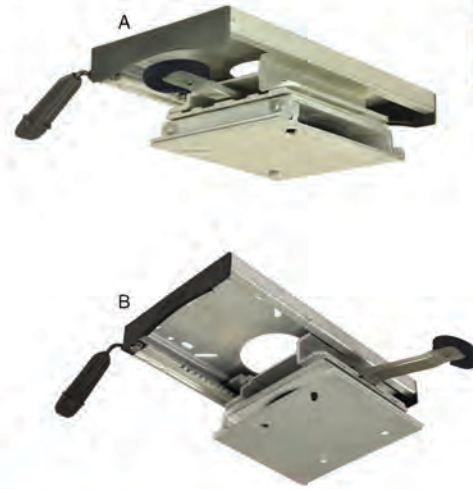
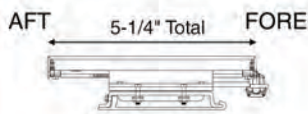

Tru-Lock is Rated
ABYC Class H-31 AD

Workhorse Bench Mount

OEM				
Image	Part Number	Description	Pack Quantity	ABYC
A.	3100571-S	Workhorse Bench Mount Slide	1 Pack	AD

10-1/2" x 14-1/2" aluminum formed slide plate. Heavy-duty stainless steel lock pin. Slide travels 6" fore and aft.

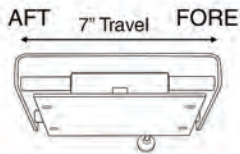

Elite Slides Are Rated
ABYC Class H-31 AD



Elite 100 Slide & Swivel Mount

OEM				
Image	Part Number	Description	Pack Quantity	ABYC
A.	3100401	Elite 100 Slide & Swivel Mount	6 Pack	AD

Unique design allows easy installation, made from high-strength aluminum construction. 8-1/2" x 13" seat mount platform, travels 5-3/8" for and aft. 8 locking positions.

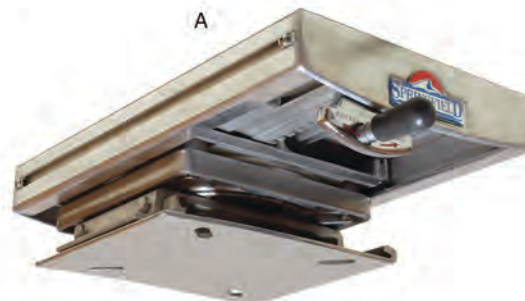
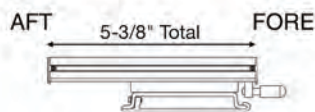

Elite Slides Are Rated
ABYC Class H-31 AD



Mounting Systems

Heavy-Duty Front Lever and Electric Slides

OEM				
Image	Part Number	Description	Pack Quantity	ABYC
A.	3100545	Front Lever Heavy-Duty Slide	10 Pack	AD
B.	3100545-EW	Heavy-Duty 52" Wide, Electric Slide	1 Pack	AD
C.	3100545-W	Heavy-Duty 28" Wide, Slide	1 Pack	AD
B.	3101545-EW	Heavy-Duty 31-1/2" Wide, Electric Slide	1 Pack	AD

(A. & C) Front Lever Slides:

- High-strength anodized aluminum construction.
- Travels fore and aft 6" on heavy-duty rails.
- Double latch towel bar slide. Includes top and bottom mounting plate.

(B.) Electric Heavy-Duty Slide:

- High-strength anodized aluminum construction.
- Electric motor operates on 12 volts DC power.
- Smooth and quiet operation.



Front Lever Slide



Electric - Wide Slide



Wide Front Lever Slide

Front Lever Slides Are Rated ABYC Class H-31 AD



Low Profile Slides

OEM				
Image	Part Number	Description	Pack Quantity	ABYC
A.	3100045	Quick Mount for Low Profile Slide	1 Pack	-
B.	3100646	Low Profile Slide	1 Pack	AD
C.	3100656	Low Profile Slide & Swivel	1 Pack	AD

(A. & B.) Low Profile Slide & Quick Mount

- High-strength anodized aluminum construction
- Stainless steel front activation handle bar
- Quick mount for easy installation
- Travels 5" fore and aft
- Only 1.25" thick

(C.) Low Profile Slide & Swivel

- High-strength anodized aluminum construction
- Pivot and front activation handle rotate with seat
- Slides 6" fore and aft on heavy-duty rails with nylon glides for smooth travel
- 1-5/8" thick



Low Profile Slide



Low Profile Slide & Swivel

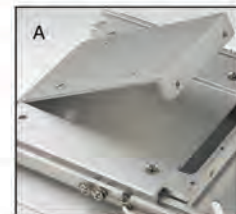

Quick Mount for Low Profile Slide

Low Profile Slides Are Rated ABYC Class H-31 AD



Universal Trac-Lock™ Slide

Retail				
Image	Part Number	Description	Pack Quantity	ABYC
A.	1100300	Universal Trac-Lock™ Slide	6 Retail	AD

OEM				
Image	Part Number	Description	Pack Quantity	ABYC
A.	3100300	Universal Trac-Lock™ Slide	10 Bulk	AD

Retail packages are packed in clamshell with 4 color label

Large 7-1/4" x 13" high, 0-degree platform. Travels 5-1/4" fore and aft. High-strength anodized aluminum. Can be used as box or pedestal mount. Adds 2" to height of seat.

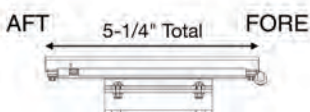

Universal Slides Are Rated ABYC Class H-31 AD



Universal Chair Slide

OEM				
Image	Part Number	Description	Pack Quantity	ABYC
A.	3100202	Universal Low Pro Chair Slide	10 Bulk	AD

Universal Chair Slide Is Rated ABYC Class H-31 AD



13" x 18.25" slide platform, travels 5" fore and aft. Mounts easily to most seats. Universal Chair Slide adds 1" to height of seat. Loosen handle to activate the slide.

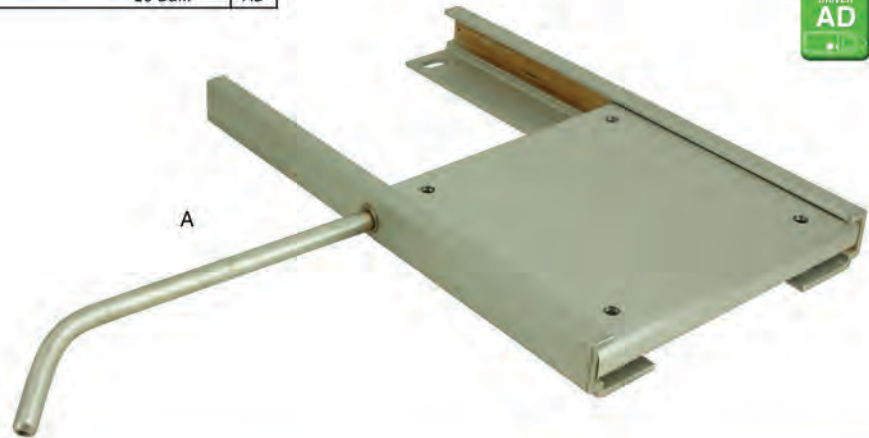

Quick Seat Mount

Retail				
Image	Part Number	Description	Pack Quantity	ABYC
A.	1100016	Quick Seat Mount & Rails - Travels 27" Side to Side	6 Retail	AD
B.	1100017	Quick Seat Mount & Rails - Travels 6.5" Side to Side	6 Retail	AD

Quick Seat Mounts Are Rated ABYC Class H-31 B



OEM				
Image	Part Number	Description	Pack Quantity	ABYC
B.	3100017	Quick Seat Mount & Rails - Travels 6.5" Side to Side	20 Bulk	AD
C.	3100036-BLK	Black Anodized Seat Mount Plate Only	20 Pack	AD
D.	3100038-BLK	15" Black Anodized Rail, With End Caps	20 Bulk	AD
E.	3100039	44" Satin Anodized Rail Only	20 Pack	AD

Easy to install and remove from boat. Bracket allows seat to slide side to side for comfort and convenience. Locking mechanism prevents tipping forward in sudden stop situations.



15" Black Anodized Rail w/ End Caps



44" Satin Anodized Rail



6.5" Quick Mount



27" Quick Mount



Black Anodized Mounting Plate

Universal Mounting Plate

OEM			
Image	Part Number	Description	Pack Quantity
A.	3100207	Mounting Plate	10 Bulk

Adapts a swivel mount to fit most seat mount patterns. High-strength aluminum. Use with any Springfield Marine swivel

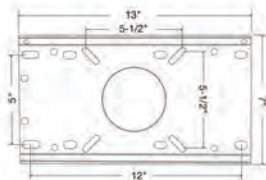

Mounting Systems

Seat Suspension System

Seat Suspension System Is
Rated ABYC Class H-31 B



Retail				
Image	Part Number	Description	Pack Quantity	ABYC
A.	1840220	Seat Suspensions System	1 Retail	B

OEM				
Image	Part Number	Description	Pack Quantity	ABYC
A.	3840220	Seat Suspension System	10 Bulk	B

Retail packages are packed in box with 4 color label

7" x 8-1/2" x 2-1/2" high. High-strength aluminum.
Heavy-duty springs provide a comfortable ride.

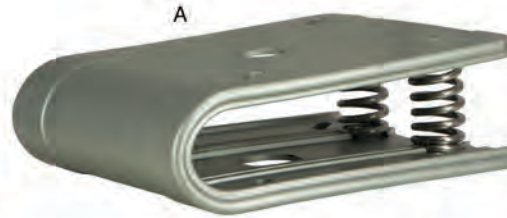
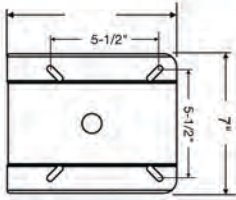

Slide Rails

OEM				
Image	Part Number	Description	Pack Quantity	
A.	3100205	2-Piece Chair Slide Rails	10 Bulk	
B.	3100205-M	2-Piece Chair Slide Rails - Bent Handle	10 Bulk	

Stainless steel slide rails are available as 2-piece set, with straight or bent handle
Includes 1-1/8" mounting studs.

Slide rails travel 6" fore and aft.

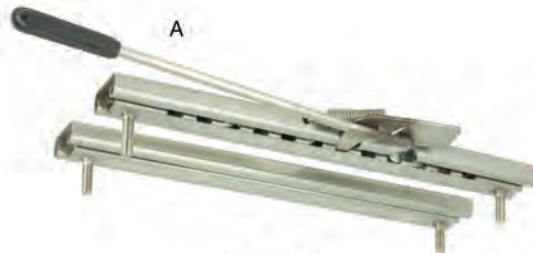

1-1/8" Studs

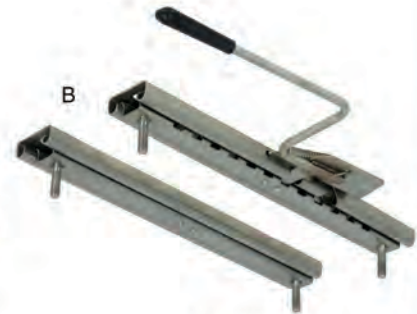

Bent Handle

Heavy-Duty Slide Rails

Heavy-Duty Slide Rails Are
Rated ABYC Class H-31 AD

OEM					
Image	Part Number	Description	Studs	Pack Quantity	ABYC
A.	3100534-L	2-Piece Slide Rails, Locking	Not Included	10 Bulk	AD
B.	3100534-L3M	3-Piece Slide Rails, Locking	Not Included	10 Bulk	AD
C.	3100534-LSH	2-Piece Slide Rails, Short	Not Included	10 Bulk	AD
D.	3100534-S	2-Piece Slide Rails, Locking	Included	10 Bulk	AD
E.	3100548	2-Piece Slide Rails, Non Locking	Not Included	1 OEM	AD

Slide rails for large seats any where in the boat.
High-strength aluminum to withstand all conditions.
Travels 7" fore and aft.

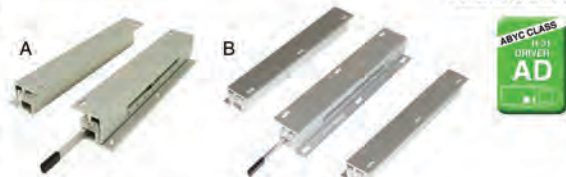

2-Piece Set

3-Piece Set



2-Piece Set
Short Locking Handle



2-Piece Set
w/ Studs



2-Piece
Non-Locking



Universal Trac-Lock™ With 12-Way Swivel

Retail				
Image	Part Number	Description	Pack Quantity	ABYC
A.	1100318	Universal With E-Coat Swivel	1 Retail	AD
B.	1100319	Universal With Stainless Steel Swivel	1 Retail	AD

OEM				
Image	Part Number	Description	Pack Quantity	ABYC
A.	3100318	Universal With E-Coat Swivel	10 Bulk	AD
B.	3100319	Universal With Stainless Steel Swivel	10 Bulk	AD

Large 7-1/4" x 13" x 3" high, 0-degree platform. Travels 5-1/2" fore and aft. Mounted on 12-Way swivel, rotates°. Swivel available in mild steel with e-coat finish or stainless steel.

Patent #5,782,451

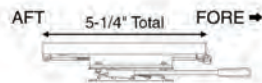

Universal Slides Are Rated ABYC Class H-31 AD



12-Way Locking Swivels

Retail					
Image	Part Number	Description	Finish	Pack Quantity	ABYC
A.	1100018	0-Degree Locking Swivel	E-Coat	1 Retail	AD
B.	1100019	0-Degree Locking Swivel	Stainless Steel	1 Retail	AD

OEM					
Image	Part Number	Description	Finish	Pack Quantity	ABYC
A.	3100018	0-Degree Locking Swivel	E-Coat	20 Bulk	AD
B.	3100019	0-Degree Locking Swivel	Stainless Steel	20 Bulk	AD

Retail packages are packed in clamshell with 4 color label

6-3/4" square x 1-1/8" high, with 4 hole mounting pattern. Locking swivel, rotates 360°. Available in two finishes: e-coat finish or stainless steel.

Patent #5,782,451

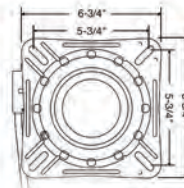

12-Way Swivels Are Rated ABYC Class H-31 AD



Non-Locking Swivels

Retail					
Image	Part Number	Description	Finish	Pack Quantity	ABYC
A.	1100007	0-Degree Non-Locking Swivel	E-Coat	1 Pack	B
B.	1100009	0-Degree Non-Locking Swivel	Stainless Steel	1 Pack	B

OEM					
Image	Part Number	Description	Finish	Pack Quantity	ABYC
A.	3100007	0-Degree Non-Locking Swivel	E-Coat	20 Bulk	B
B.	3100009	0-Degree Non-Locking Swivel	Stainless Steel	20 Bulk	B

Retail packages are packed in clamshell with 4 color label

6-3/4" square x 1-1/8" high, with 4 hole mounting pattern. 0-degree non-locking swivel, rotates 360°. Available in two finishes: e-coat finish or stainless steel.

Patent #5,782,451

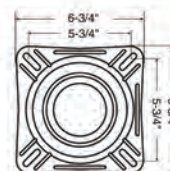

Non-Locking Swivels Are Rated ABYC Class H-31 B



Mounting Systems

Pro-Tilt Seat Mount

Retail					
Image	Part Number	Description	Finish	Pack Quantity	ABYC
A.	1780010	Pro-Tilt Seat Mount	E-Coat	6 Retail	B

Retail packages are packed in box with 4 color label

7" x 7" seat mount with 4 mounting holes.
Spring-loaded locking mechanism, tit angles: 3°, 15°, 25°, 30°, 40°, & 50°
E-coated mild steel to resist corrosion

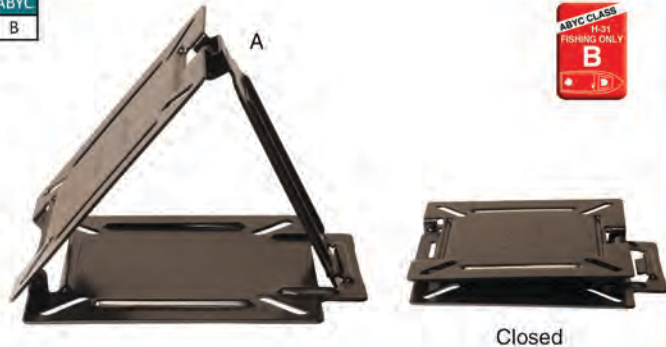
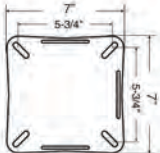

Jon Boat Seat Clamps Are Rated ABYC Class H-31 B

Removable 7" x 7" Seat Brackets

Retail					
Image	Part Number	Description	Finish	Pack Quantity	ABYC
A.	1100015	Removable Seat Bracket		6 Retail	B
B.	1100115	Removable Seat Bracket & Swivel		6 Retail	B

OEM					
Image	Part Number	Description	Finish	Pack Quantity	ABYC
A.	3100015	Removable Seat Bracket		20 Bulk	B

Retail packages are packed in clamshell with 4 color label

7" x 7" removable seat bracket.
Non-locking seat swivel, rotates 360°.
Swivel has e-coat finish to resist corrosion.

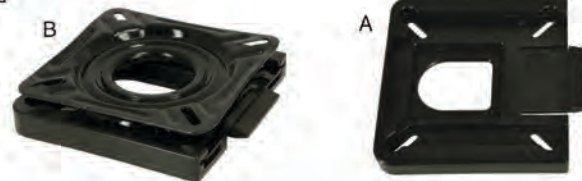
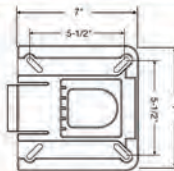

Removable Brackets Are Rated ABYC Class H-31 B

Heavy-Duty Seat Swivel

Retail					
Image	Part Number	Description	Finish	Pack Quantity	ABYC
A.	1100050	Non-Locking Swivel		6 Retail	B
B.	1100050-L	Locking Swivel		6 Retail	AD
C.	1100550-L	Locking Slide & Swivel		1 Retail	AD

OEM					
Image	Part Number	Description	Finish	Pack Quantity	ABYC
A.	3100050	Non-Locking Swivel		20 Bulk	B

7" x 7" swivel with 4 mounting hole pattern 0-degree tilt
Powder coat finish to resist corrosion. Rotates 360°.
Slide travels 5-1/4" fore and aft.

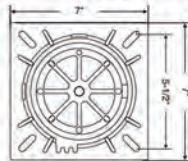

(B. & C.) 4 Locking positions - pull handle up to rotate.



Heavy-Duty Swivels Are Rated ABYC Class H-31 AD & B

Jon Boat Seat Clamp

Retail					
Image	Part Number	Description	Adjusts	Pack Quantity	ABYC
A.	1100012	Economy Seat Clamp	8" to 19"	1 Retail	B
A.	1104010	Jon Boat Seat Clamp	8" to 20-1/2"	1 Retail	B
B.	2100097	Jon Boat Safety Clip	-	1 Retail	-

Retail packages are packed in box with 4 color label

Adjustable Seat Clamp to fit most bench seats. E-coated steel to resist corrosion.

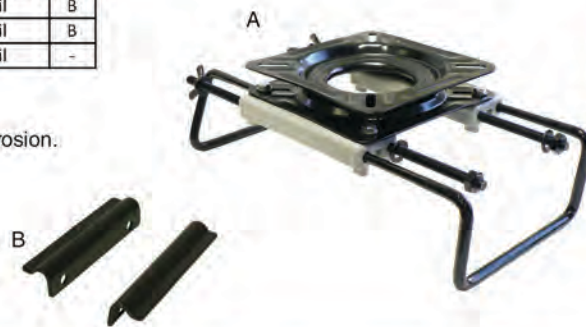
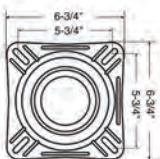

Jon Boat Seat Clamps Are Rated ABYC Class H-31 B

Economy Fixed Height Pedestals

Retail					
Image	Part Number	Fixed Height	Finish	Pack Quantity	ABYC
A.	1561105	7"	E-Coat	6 Retail	B
B.	1561106	13"	E-Coat	6 Retail	B

Retail packages are packed in box with 4 color label

7" x 7" square base and seat mount. Rugged, all steel construction. E-coat corrosion resistant finish for all weather conditions. For use with standard boat seats.

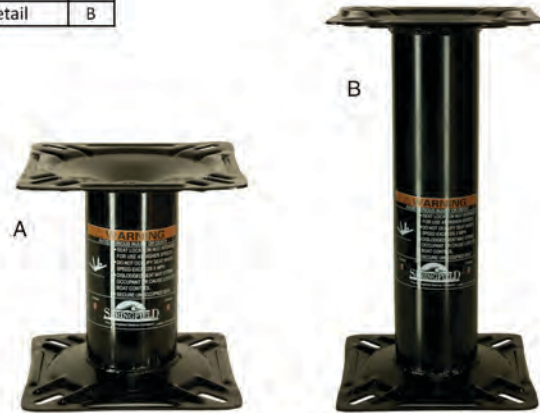
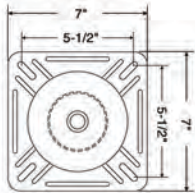

Economy Pedestals Are Rated ABYC Class H-31 B



Economy Adjustable Pedestals

Retail					
Image	Part Number	Adjusts	Finish	Pack Quantity	ABYC
A.	1561107	12" to 18"	E-Coat	6 Retail	B

Retail packages are packed in box with 4 color label

7" x 7" square base and seat mount. Rugged, all steel construction. E-coat corrosion resistant finish for all weather conditions. Adjusts from 12" to 18" in 2" increments. For use with standard boat seats.

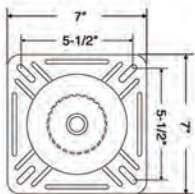

Economy Pedestals Are Rated ABYC Class H-31 B



Springfield Belle Adjustable Pedestal

Retail					
Image	Part Number	Adjusts	Finish	Pack Quantity	ABYC
A.	1440248	13" to 17"	Powder Coat	1 Retail	B

Retail packages are packed in box with 4 color label

Adjustable post with 10" round base and Trac-Lock™ seat mount. Rotates 360°, easy to grip handles. Fits standard boat seats. Corrosion resistant powder coat finish.

Patent #5,758,856

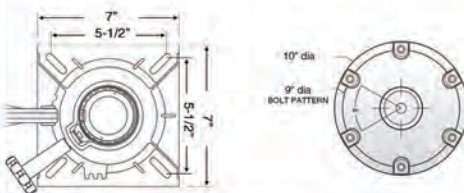

Springfield Belle Pedestals Are Rated ABYC Class H-31 B



Grills & Tables

ABOUT GRILLS & TABLES

Springfield Marine's grills & tables enhance your on the water dining experience. Designed to be used on board, our grills and tables allow you to extend your boating pleasure by reducing your need to go ashore. At mealtime or snack time, simply set up, cook, and enjoy.

Our grills and tables are available in a wide range of styles to suit your needs. To add to your convenience, all grills and tables are removable for easy storage to keep your lounging area spacious and free for other activities when not in use.

Springfield Marine reminds you to always use caution whenever operating a barbecue grill; especially on the water.



BBQ GRILLS • TABLE PACKAGES • TABLE TOPS • TABLE TIPS • POSTS • MOUNTS • BASES • ACCESSORIES

Grill Packages

Retail			
Image	Part Number	Description	Pack Quantity
A.	1940049	Grill Only	1 Retail
B.	1940052	Grill With Thread-Lock™	1 Retail
C.	1940054	Grill With Multi-Fit Rail Mount Kit	1 Retail
D.	1940057	Grill With Trailer Hitch Mount	1 Retail

Retail packed in box with 4 color label

All models convert to table top grill.
 189 sq. in. grill cooking surface.
 130 sq. in. griddle surface on top of lid.
 12,000 BTU rating.
 Use with a 1lb propane tank (not included).

WARNING
 ALWAYS USE CAUTION
 WHEN OPERATING GRILL

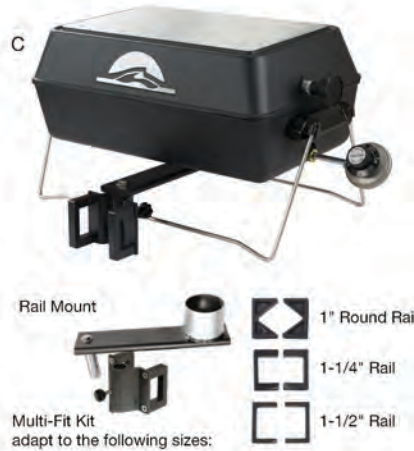
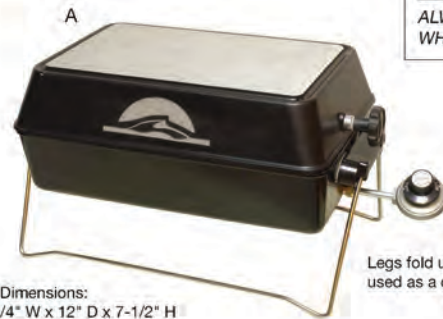

Service Parts

OEM			
Image	Part Number	Description	
A.	2100145	Cooking Grate	
B.	2100146	Heat Transfer Plate	
C.	2100148	Stainless Steel Burner	
D.	2100149	Gas Regulator	
E.	2100151	Carrying Handles	
F.	2100184	Rail Mount With Multi-Fit Kit	
G.	1940059	Retrofit Kit With Multi-Fit Kit	
H.	2171039	Replacement Post	

Service and replacement parts for bbq grill packages.

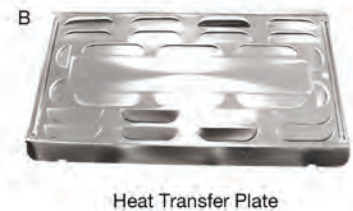
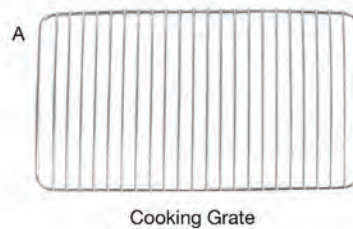

Grills & Tables

Table Tops

Retail				
Image	Part Number	Table Top	Umbrella Socket	Pack Quantity
A.	1670002	Round	No	1 Retail
A.	1670002-U	Round	Yes	1 Retail
B.	1670006	Oval	No	1 Retail
B.	1670006-U	Oval	Yes	1 Retail
C.	1670008	Rectangular	No	1 Retail
D.	1670009	Party Platter	No	1 Retail

Light-weight, molded heavy-duty marine grade plastic. Available in 4 shapes and sizes with drink holders. Available as plain or with umbrella socket.

Umbrella socket cover (white) included with umbrella models. Part Number: 7100170-W



D
Party Platter



A
Round
24" Diameter



Umbrella socket

B
Oval
18" x 30"



Umbrella socket

C
Rectangle
16" x 28"



Party Platter Package

Retail				
Image	Part Number	Table Top	Umbrella Socket	Pack Quantity
A.	1690901	Party Platter	No	1 Retail

Package Includes:

- Party Platter table top, 5 cup holders
- Plastic table mount built into table top
- 2-Piece anodized aluminum locking Thread-Lock™ post
- Thread-Lock™ black plastic surface mount base

A

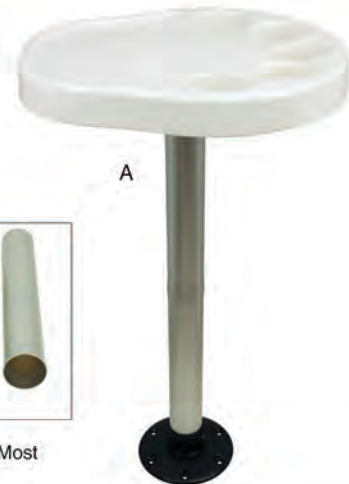

Stows Easily To Fit In Most Compartments!

Thread-Lock™ Table Packages

Retail					
Image	Part Number	Table Top	Table Size	Umbrella Socket	Pack Quantity
A.	1690102	Round	24"	No	1 Retail
B.	1690106	Oval	18" x 30"	No	1 Retail
C.	1690107	Rectangle	16" x 28"	No	1 Retail

- Packages include the following parts:
- 27" Thread-Lock™ table pedestal set
 - Table top, available as round, oval, or rectangular

Surface Mount.



Stowable Table Packages

Retail					
Image	Part Number	Table Top	Table Size	Umbrella Socket	Pack Quantity
A.	1690202	Round	24"	No	1 Pack
B.	1690206	Oval	18" x 30"	No	1 Pack
C.	1690207	Rectangle	16" x 28"	No	1 Pack

- Packages include the following parts:
- 27" Stowable table pedestal set
 - Table top, available as round, oval, or rectangular

Recess Mount.



Q Table Bracket

Retail				
Image	Part Number	Description	Material	Pack Quantity
A.	1660250	Flush Mount Q-Table	316 Stainless Steel	1 Pack
B.	1660250-EC	Flush Mount Q-Table	Mild Steel E-Coat	1 Pack

The Q Table Bracket is a flush mounted table bracket that stows flush against a wall, then can be extended to provide a solid table surface. Available in 316 stainless steel or e-coated mild steel.



Stowed Position

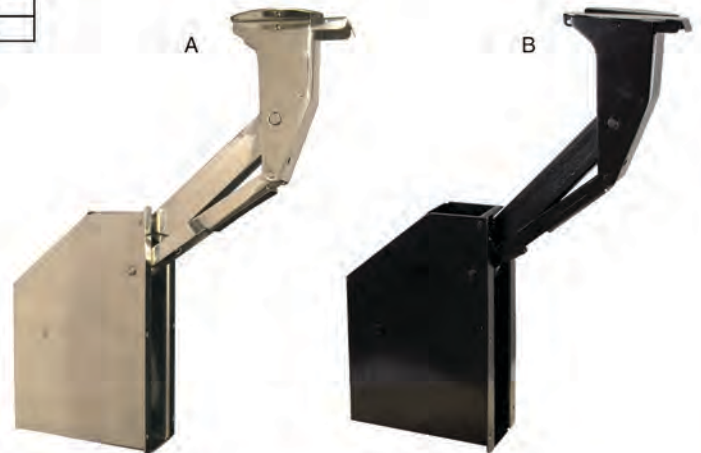

Grills & Tables

3-Stage Table Pedestals

Gas Powered 3-Stage Aluminum Pedestals

Image	Part Number	Adjusts	Finish	Pack Quantity
A.	1660230	12-3/4"; 20"; 28"	Anodized	1 Retail
B.	1660230-BLK	12-3/4"; 20"; 28"	Black Anodized	1 Retail
A.	1660231	14"; 20"; 28"	Anodized	1 Retail
C.	1660232	14"; 20"; 28"	Brite Dip	1 Retail
D.	1660232-KP	15" to 28"	Brite Dip	1 Retail

Gas Powered Pedestals with 12-1/2" table mount and 12" dia. floor base with 11" hole pattern for added stability.

Made from high-strength aluminum, available in a variety of heights and finishes.

3-Stage table pedestals are designed to bring maximum strength and support to your dining experience.



3-Stage sturdy adjustable table pedestals



A



B



C

D



Use with Trac-Lock™
2-7/8" chrome swivel



Adjusts 15" to 28" with swivel

Use with threaded KingPin™
base (sold separately)



3-Stage adjustable pedestal
with base & swivel



Threaded Pin

Thread-Lock™ Pedestal Set

Retail				
Image	Part Number	Table Mount	Base Finish	Pack Quantity
A.	1690727-SL	Plastic	Satin	1 Pack

Thread-Lock™ Pedestal Package Includes:

- 2-3/8" diameter anodized aluminum fixed height post with latch
- High-strength black plastic table mount
- 7" aluminum surface mount floor base with a 5-3/4" hole pattern and satin finish



Thread-Lock™ Double Locking Posts

Retail				
Image	Part Number	Fixed Height	Finish	Pack Quantity
A.	1692027-L	27"	Anodized	1 Bulk

OEM				
Image	Part Number	Fixed Height	Finish	Pack Quantity
B.	3692027-CPL	27"	Brite Dip	20 Bulk
A.	3692027-L	27"	Anodized	20 Bulk
C.	3692027-LU	27"	Anodized	20 Bulk
A.	3692029-L	29"	Anodized	20 Bulk

2-3/8" double locking posts.

Smooth anodized finish or fluted brite dip finish.

Use with any 2-3/8" Stowable table mount (sold separately).

Works with any Thread-Lock™ table base (sold separately).



Thread-Lock™ Uni-Lock Posts

OEM				
Image	Part Number	Fixed Height	Finish	Pack Quantity
A.	3691014-L	14"	Anodized	20 Bulk
B.	3691027	27"	Anodized	20 Bulk
C.	3691027-CPL	27"	Brite Dip	20 Bulk
A.	3691027-L	27"	Anodized	20 Bulk
A.	3691028-L	28"	Anodized	20 Bulk
B.	3692128	28"	Anodized	20 Bulk

2-3/8" Uni-Lock posts.

Use with Uni-Lock table mount #3660704-L (sold separately).

Works with any Thread-Lock™ table base (sold separately).

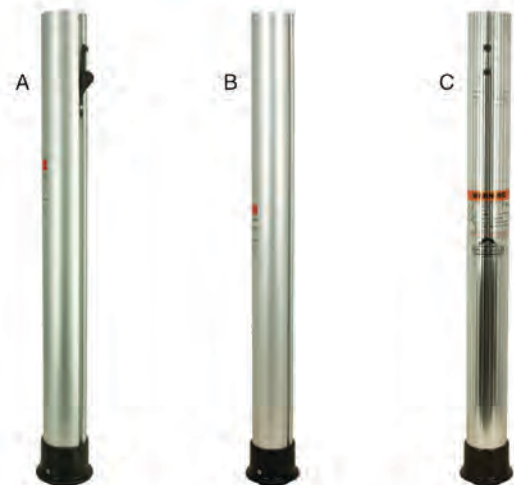

Grills & Tables

Thread-Lock™ Adjustable Pedestal

OEM				
Image	Part Number	Adjusts	Finish	Pack Quantity
A.	3692700	21-1/2" to 27-1/2"	Polished	1 Pack

2-3/8" stainless steel polished post, adjusts from 21-1/2" to 27-1/2"
 Works with any 2-3/8" Stowable table mount (sold separately).
 Works with any Thread-Lock™ table base (sold separately).

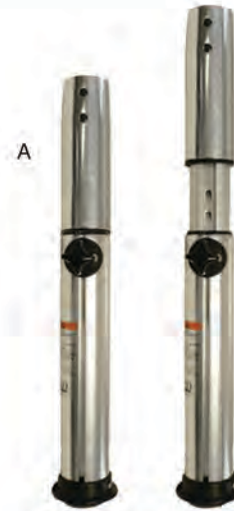

Thread-Lock™ Table Bases

Retail				
Image	Part Number	Locking or Non-Locking	Finish	Pack Quantity
D.	1690001-SL	Locking	Satin	6 Pack

OEM				
Image	Part Number	Locking or Non-Locking	Finish	Pack Quantity
A.	3690001	Non-Locking	Black Plastic	20 Bulk
B.	3690001-AL	Locking	Anodized	20 Bulk
C.	3690001-BLKL	Locking	Black Krinkle	20 Bulk
D.	3690001-SL	Locking	Satin	20 Bulk

2-3/8" Threaded table base. High-strength aluminum, available in four finishes: Anodized, Satin, Silver Metallic or Black. 7" diameter with 5-3/4" hole pattern. Works with any 2-3/8" Thread-Lock™ table post (sold separately).

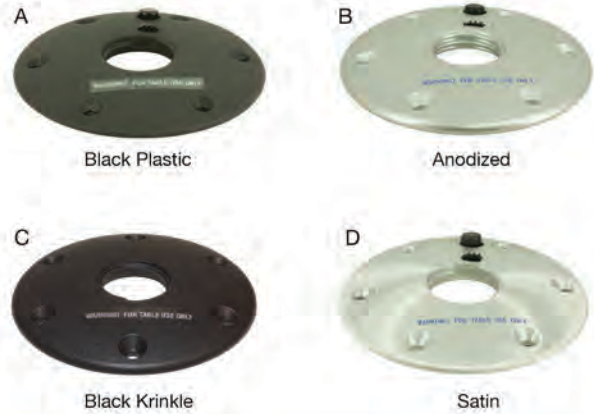

Stowable Pedestal Sets

Retail					
Image	Part Number	Diameter	Finish	Locking	Pack Quantity
A.	1660012	2-3/8"	Polished	Non-Locking	1 Pack
B.	1660029	2-3/8"	Anodized	Non-Locking	1 Pack
C.	1660029-L	2-3/8"	Anodized	Locking	1 Pack

Package includes:
 • 2-3/8" diameter aluminum post
 • High-strength aluminum table mount
 • 7" aluminum surface mount floor base with 5-3/4" hole pattern

Requires a 3-1/2" hole in deck.

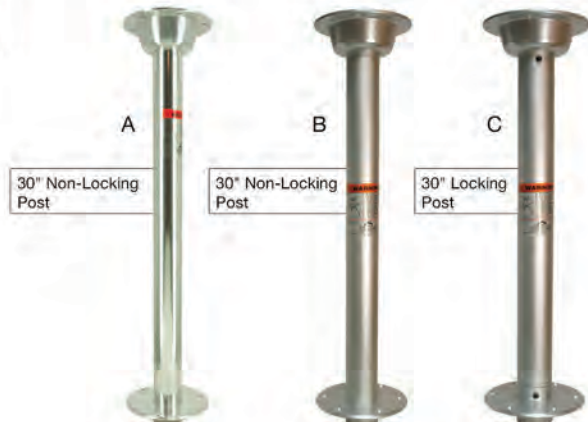

Stowable Table Mounts

Retail				
Image	Part Number	Finish	Diameter	Pack Quantity
A.	1660018	Anodized	2-3/8"	1 Pack

OEM				
Image	Part Number	Finish	Diameter	Pack Quantity
A.	3660018	Anodized	2-3/8"	20 Bulk
B.	3660023	Polished	2-3/8"	20 Bulk

Locking groove table mount. High-strength aluminum. Choice of two finishes: Anodized or Polished. 7" diameter mount with 5-3/4" hole mounting pattern. Works with any tapered 2-3/8" Thread-Lock™ post or any 2-3/8" Stowable table post (sold separately).

Permanent Mold



Anodized



Polished

Economy Stowable Table Mounts

Retail				
Image	Part Number	Finish	Diameter	Pack Quantity
A.	1660004	Kennedy Gray	2-3/8"	1 Pack

OEM				
Image	Part Number	Finish	Diameter	Pack Quantity
A.	3660004	Kennedy Gray	2-3/8"	20 Bulk
B.	3660004-BLK	Black Krinkle	2-3/8"	20 Bulk
C.	3660004-SM	Silver Metallic	2-3/8"	20 Bulk

Non-locking 2-3/8" table mount. High-strength aluminum. Choice of three finishes: Kennedy, Black Krinkle, or Silver Metallic. 7" diameter with 5-3/4" hole pattern. Works with any 2-3/8" Stowable table post (sold separately).

Die Cast



Kennedy Gray



Black Krinkle



Silver Metallic

Locking Stowable Table Posts

OEM				
Image	Part Number	Fixed Height	Finish	Pack Quantity
A.	3660525	25"	Anodized	20 Bulk
B.	3660527	27"	Anodized	20 Bulk

2-3/8" post locks into place to prevent accidental removal. Available in a wide selection of heights, with anodized finish. Works with any 2-3/8" Stowable table mount (sold separately). Works with any 2-3/8" Stowable table base (sold separately).

A
25" Post



B
27" Post



Grills & Tables

Stowable Table Posts

Retail				
Image	Part Number	Fixed Height	Finish	Pack Quantity
A.	1660032-A	27"	Anodized	6 Pack
A.	1660030-A	28"	Anodized	6 Pack
A.	1660037-A	29"	Anodized	6 Pack
A.	1660024-A	30"	Anodized	6 Pack

OEM				
Image	Part Number	Fixed Height	Finish	Pack Quantity
A.	3660026-A	25"	Anodized	20 Bulk
B.	3660026-P	25"	Polished	20 Bulk
A.	3660032-A	27"	Anodized	20 Bulk
B.	3660032-P	27"	Polished	20 Bulk
A.	3660030-A	28"	Anodized	20 Bulk
A.	3660037-A	29"	Anodized	20 Bulk
A.	3660024-A	30"	Anodized	20 Bulk

2-3/8" post available in a wide variety of heights.
Anodized or polished aluminum finish.
Works with any 2-3/8" Stowable table mount (sold separately).
Works with any 2-3/8" Stowable table base (sold separately).



Anodized

Polished

Economy Stowable Posts

OEM				
Image	Part Number	Fixed Height	Finish	Pack Quantity
A.	3660324	24"	Anodized	20 Bulk
B.	3660325	25"	Anodized	20 Bulk
C.	3660327	27"	Anodized	20 Bulk
D.	3660328	28"	Anodized	20 Bulk
E.	3660330	30"	Anodized	20 Bulk

2-3/8" post with anodized finish.
Works with any 2-3/8" Stowable table mount (sold separately).
Works with any 2-3/8" Stowable table base (sold separately).

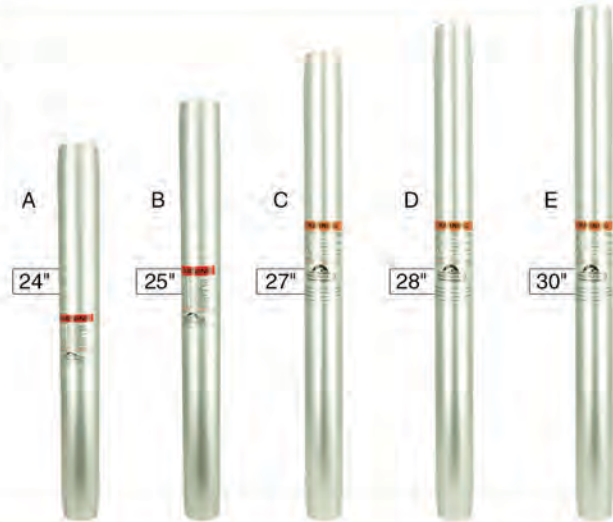

A

B

C

D

E

24"

25"

27"

28"

30"

Stowable Table Bases

Retail				
Image	Part Number	Locking	Finish	Pack Quantity
A.	1660001	Locking	Polished	1 Pack
B.	1660003	Non-Locking	Kennedy	1 Pack
C.	1660017	Locking	Anodized	1 Pack

OEM				
Image	Part Number	Locking	Finish	Pack Quantity
A.	3660002	Locking	Polished	20 Bulk
B.	3660003	Non-Locking	Kennedy	20 Bulk
C.	3660017	Locking	Anodized	20 Bulk
D.	3660017-BLK	Non-Locking	Black Krinkle	20 Bulk

High-strength aluminum, with choice of four finishes: Anodized, Polished, Kennedy Gray, or Black Krinkle. 7" diameter, with 5-3/4" hole mounting pattern. Available as locking or non-locking.
Works with any 2-3/8" Stowable table post (sold separately).

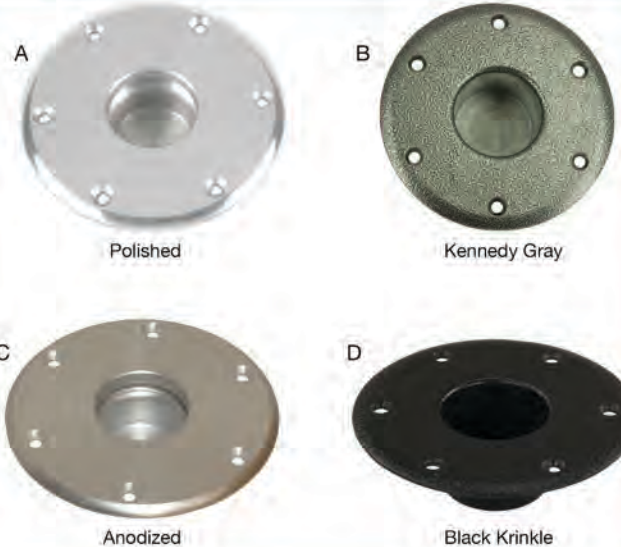

A

B

Polished

Kennedy Gray

C

D

Anodized

Black Krinkle

Uni-Lock Pedestal Set

Retail			
Image	Part Number	Description	Pack Quantity
A.	1660701	Locking Uni-Lock Pedestal Package	1 Pack
B.	1660702	Non-Locking Uni-Lock Pedestal Package	1 Pack

(A.) Package includes:

- 2-3/8" diameter locking anodized aluminum post
- High-strength black plastic table mount & floor base

(B.) Package includes:

- 2-3/8" diameter non-locking anodized aluminum post
- High-strength black plastic table mount & floor base

7" floor base with 5-3/4" mounting hole pattern.
Requires a 3-1/2" hole in deck.

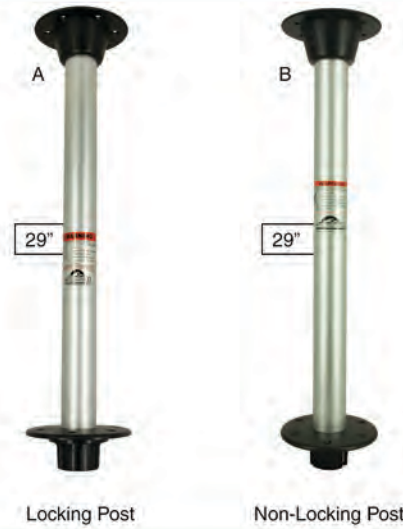

Uni-Lock Table Mount

Retail			
Image	Part Number	Description	Pack Quantity
A.	1660704-L	Black Plastic Uni-Lock Table Mount	1 Pack

OEM			
Image	Part Number	Description	Pack Quantity
A.	3660704-L	Black Plastic Uni-Lock Table Mount	20 Pack

2-3/8" table mount, made from high-strength black plastic.
7" diameter with 5-3/4" hole pattern.
Works with any 2-3/8" Uni-Lock table post (sold separately).



Uni-Lock Table Posts

OEM				
Image	Part Number	Fixed Height	Locks	Pack Quantity
A.	3660727-L2	27"	2 Locks	20 Bulk
B.	3660727	27"	Non-Locking	20 Bulk

2-3/8" post with anodized finish.
Available as locking or non-locking.
Use with Uni-Lock table mount #3660704-L and
Uni-Lock table base #3660703 (sold separately).

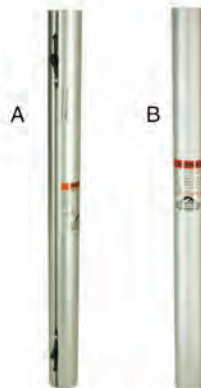

Uni-Lock Table Base

Retail			
Image	Part Number	Description	Pack Quantity
A.	1660703	Black Plastic Uni-Lock Table Base	1 Pack

OEM			
Image	Part Number	Description	Pack Quantity
A.	3660703	Black Plastic Uni-Lock Table Base	20 Bulk

2-3/8" table base, high-strength
black plastic. 7" diameter with 5-3/4"
hole pattern. Works with any 2-3/8"
Uni-Lock table post (sold separately).



Grills & Tables

2-7/8" Stowable Table Package

Retail			
Image	Part Number	Description	Pack Quantity
A.	1661127-CAL	2-7/8" Table Package - Anodized Fluted	1 Pack
B.	1661624	2-7/8" Surface Mount Package - Anodized	1 Pack
C.	1661624-P	2-7/8" Surface Mount Package - Polished	1 Pack

(A.) Package includes:

- 2-7/8" diameter aluminum post - Anodized Fluted
- High-strength anodized aluminum table mount
- Anodized aluminum thru-deck floor base

9" floor base with 8" mounting hole pattern.
Requires a 3-1/2" hole in deck.

(B. & C) Package includes:

- 2-7/8" diameter aluminum post - Anodized or Polished
- High-strength anodized aluminum table mount
- Anodized aluminum surface mount floor base



2-7/8" Stowable Table Mount

OEM			
Image	Part Number	Description	Pack Quantity
A.	3660207	2-7/8" Stowable Table Mount - Anodized	20 Pack

2-7/8" high-strength anodized aluminum table mount.
9" diameter with 8" mounting hole pattern.

Works with any 2-7/8" stowable table post (sold separately).



2-7/8" Stowable Table Posts

OEM				
Image	Part Number	Fixed Height	Finish	Pack Quantity
A.	3664230-RV	23"	Polished	10 Bulk
A.	3664250-RV	25"	Polished	10 Bulk
B.	3660127-CAL	27"	Anodized	20 Bulk
C.	3660127-CPL	27"	Polished	20 Bulk
A.	3664275-RV	27-1/2"	Polished	10 Bulk
A.	3664300-RV	29-1/2"	Polished	20 Bulk

2-7/8" high-strength aluminum post with fluted anodized or polished finish, available in a variety of heights.

(A.)
Use with 2-7/8" Trac-Lock™ swivel and 2-7/8" stowable base mount (sold separately)

(B. & C.)
Use with 2-7/8" Stowable table mount and base mount (sold separately)

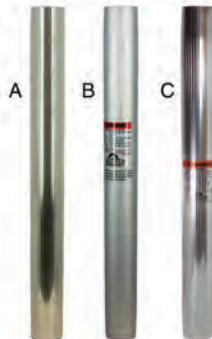

2-7/8" Stowable Table Base

OEM				
Image	Part Number	Diameter	Finish	Pack Quantity
A.	3660107	2-7/8"	Anodized	20 Bulk

2-7/8" high-strength anodized aluminum table base. 9" diameter with 8" mounting hole pattern. Works with any 2-7/8" stowable table post (sold separately).

Requires a 3-1/2" hole in deck.



Bolt Lock Pedestal Set

Retail			
Image	Part Number	Description	Pack Quantity
A.	1662127	2-3/8" Bolt Lock Table Package	1 Pack

(A.) Package includes:

- 2-3/8" high-strength aluminum post - Anodized Finish
- High-strength black plastic table mount
- Aluminum floor base - Satin Finish

7" round surface mount floor base with 5-3/4" mounting hole pattern.



Attach post to base and twist for a secure, locking fit.



Bolt-Lock Table Post

OEM				
Image	Part Number	Fixed Height	Finish	Pack Quantity
A.	3662027	27"	Anodized	20 Bulk
B.	3662027-P	27"	Brite Dip	20 Bulk
C.	3663027	27"	Anodized	20 Bulk

2-3/8" high-strength aluminum post with anodized or brite dip finish.

Use with any 2-3/8" Uni-Lock table mount and Bolt-Lock table base (sold separately).

(C.) Tapered post.

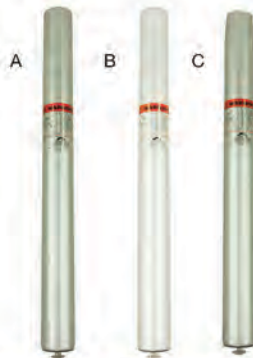

Bolt-Lock Table Bases

OEM				
Image	Part Number	Diameter	Finish	Pack Quantity
A.	3690007	2-3/8"	Satin	20 Bulk
B.	3690007-A	2-3/8"	Anodized	20 Bulk
C.	3690007-P	2-3/8"	Polished	20 Bulk

Attach post to base and twist for a secure, locking fit. 7" round floor base, with 5-3/4" hole pattern.

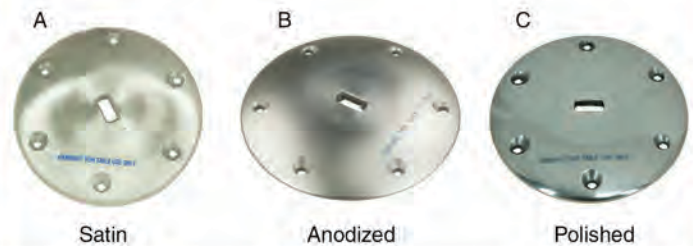

Table Accessories

Retail			
Image	Part Number	Description	Pack Quantity
A.	2100025	Stowable Post Clips	1 Pack
B.	2100092	Thread-Lock™ Base Socket Cover	1 Pack
C.	2100093	Stowable Base Socket Cover	1 Pack
D.	7100170-W	Umbrella Socket Cover	1 Pack

OEM			
Image	Part Number	Description	Pack Quantity
B.	2100092-B	Thread-Lock™ Base Socket Cover	20 Bulk
C.	2100093-B	Stowable Base Socket Cover	20 Bulk
A.	2100104	Stowable Post Clips	50 Bulk
E.	2100115	Base Latch Kit	20 Bulk

Plastic Stowable cover keeps sockets clear when not in use



Plastic cover for umbrella socket White Only



Conveniently stow your 2-3/8" table pedestals when not in use (sold in pairs, as shown)



Plastic Thread-Lock™ cover keeps sockets clear when not in use



Replacement latch kit for Thread-Lock™ table bases



Accessories

ABOUT ACCESSORIES

Although Springfield Marine is best known for some of the highest quality seating hardware in the business, we have also become well known as a supplier of fantastic boat and trailer accessories made to protect and extend the life of your boat's components and to enhance your boating fun and safety.

From practical boat mounted items such as fishing rod holders to fine recreational products like ski tow pylons, we offer a wide variety of boat accessories.

Our trailer accessories follow close behind... Practical and easy to use products from portable trailer jacks to a wide range of fully adjustable motor supports, we provide safety and functionality to make life easier at a time when you should be relaxing.

So explore the accessories that Springfield Marine has to offer and then go out and enjoy!

SKI TOWS • FOOTRESTS • ARMRESTS • GUARDIAN MOTOR SUPPORTS • FUEL COVERS



Spring-Loaded Mounting Hinges

OEM				
Image	Part Number	Description	Pack Quantity	
A.	1080040	Spring Loaded Mounting Hinge, 316 Stainless Steel	1 Pack	

This space saving design offers more room on your boat without the sacrifice of comfort or support. Easily mounts to boat for quick installation. 316 polished stainless steel.

Rated ABYC
Class H-31 AP



- Folds down easily
- Stows in up position
- Sold in pairs - Left & Right
- Available in 304 stainless steel & powder coated carbon steel



Fold Down Mounting Hinge

OEM				
Image	Part Number	Description	Pack Quantity	
A.	1080031	Fold Down Mounting Hinge	1 Pack	

Another space saving design offers room on your boat without the sacrifice of comfort or support. Easily mounts to boat for quick installation.

- Folds down easily
- Stows in down position
- Sold in pairs - Left & Right
- Made from stainless steel

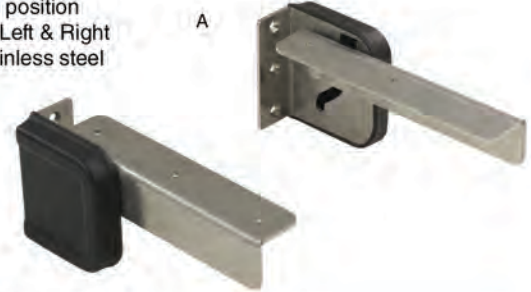

Patent Pending

Armrests With Hinge

OEM				
Image	Part Number	Description	Pack Quantity	
A.	1041104	White Armrest, No Cushions	1 Pack	
B.	1041107	White Armrest, With Cushions	1 Pack	

Armrests flip up yet offer a solid feel. Locking hinge allows backrest to fold completely parallel or in 3 lock-in tilt angles. Sold in pairs - Left & Right.

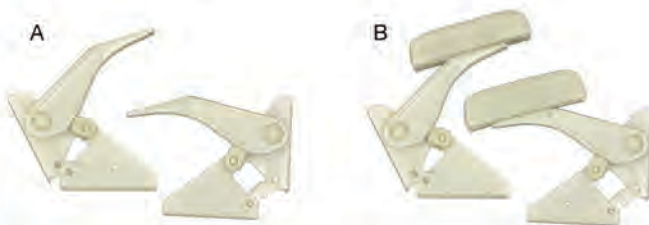

Armrest Supports

OEM				
Image	Part Number	Description	Pack Quantity	
A.	1080009-M	Anodized Armrest Supports	1 Pack	
B.	1080016-BL	Black Armrests With 101° Bend	1 Pack	

Sold in pairs - Left & Right.

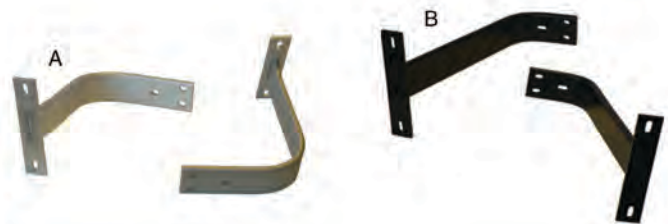

One Piece Armrest

OEM				
Image	Part Number	Description	Pack Quantity	
A.	1080013-G	One Piece Chair Armrest	1 Pack	

Sturdy polished aluminum with plastic armrests. One piece construction provides added strength.



Pinchless Hinges

OEM				
Image	Part Number	Finish	Size	Pack Quantity
A.	1080026	Mill	Large	10 Bulk
A.	1080026-BL	Black	Large	10 Bulk
B.	1080027	Mill	Medium	10 Bulk
B.	1080027-BLK	Black	Medium	10 Bulk
B.	1080027-OW	Off White	Medium	10 Bulk

High-strength aluminum with powder coat finish. Sold in pairs - Left & Right.



Accessories

Parallel Seat Hinge

OEM				
Image	Part Number	Description	Pack Quantity	
A.	3042045	Parallel Seat Hinge	10 Pack	

The stainless steel parallel seat hinges are designed to move the seat's backrest forward and back, and offers secure and stable support in either positions.

Sold in pairs as shown.



Removable Backrest

OEM				
Image	Part Number	Description	Pack Quantity	
A.	3760060	Backrest Base - 4.5" x 2"	20 Pack	
B.	3760063	14" Backrest Support	10 Pack	
B.	3760067	22" Backrest Support	20 Pack	

Constructed from high-strength aluminum with a fine satin brite dip finish. Plastic nylon inserts to provide a secure, snug fit. Drain tube allows water to escape from the base. Ball detent for secure contact and unintentional detachment. Requires 6-1/2" bellow deck.

Custom lengths available upon request



Slide-Out Footrest

Retail				
Image	Part Number	Description	Size	Pack Quantity
A.	1580074	Round Pedestal Mount	4"	1 Retail

Large 20" x 7" platform slides 8" in and out. Easy height adjustment. Polyboard platform with grooves. Aluminum mounting collar with black krinkle finish and a plastic bushing to fit 4" diameter pedestals.

Bushings available to fit 2-7/8" & 3-1/2" posts (sold separately).

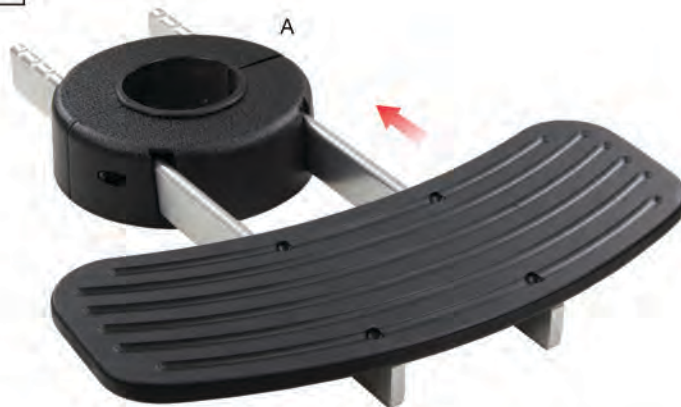

Drop-Down Footrest

Retail				
Image	Part Number	Description	Pack Quantity	
A.	1580030	Drop Down - 8-1/2" x 13-1/2" Platform	1 Retail	

Easily mounts to bottom of chair for quick installation (hardware not included). Made from polished high-strength aluminum.

Footrest flips-up for out-of-the-way storage.



Footrest & Bushing Set

Image	A.	B.	C.	Retail
Size	Black	Cast	Gray	Pack Quantity
2-7/8"	1580017-BLK	1580017	-	1 Retail
3-1/2"	1580021-BLK	-	-	1 Retail
4"	1580022-BLK	-	1580022	1 Retail

Footrest easily mounts to several sized pedestals. Split design allows mounting without removing seat. Internal plastic bushing prevents scratching of pedestal.

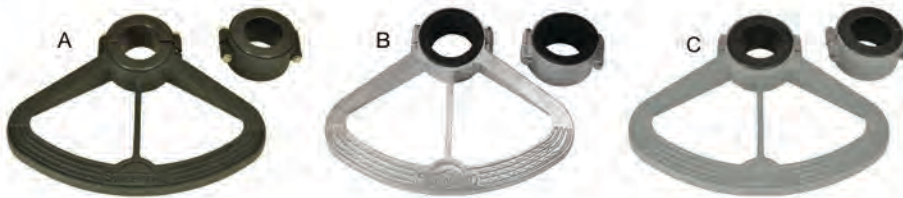

Replacement Bushings

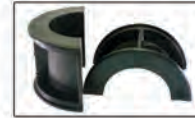

One Pack Only	
Size	Part Number
2-3/8"	2171044
2-7/8"	2171041
3-1/2"	2171042
4"	2171040

Replacement Collar Fits All Bushings Listed Above



One Pack Only	
Part Number	
2170095-BLK	



Helmsman Footrest

Image	Part Number	Description	Size	Pack Quantity
A.	1580040	11" x 16" Platform	4"	1 Retail
B.	1580045	Folding Platform	4"	1 Retail
C.	1580048	Chair Mounted Footrest	4"	1 Retail

(A. & B.) High-strength cast aluminum with black powder coat finish. Cast-in anti-slip grooves. Extends 20" out from center of post. Fits 4" post. Bushings available to fit 2-7/8" and 3-1/2" posts (sold separately).

(C.) High-strength cast aluminum with black powder coat finish. Cast-in anti-slip grooves. Footrest mounts to bottom of seat.

B. & C.
Platform pivots up for out-of-the-way storage



Stainless Steel & Aluminum Footrests

Image	Part Number	Description	Pack Quantity
A.	1580080-AL	28" Full Round Footrest - Aluminum	1 Pack
B.	1580082-AL	14" Full Round Footrest - Aluminum	1 Pack
C.	1580095-AL	Half Round Footrest - Aluminum	1 Pack
A.	1580080-SS	28" Full Round Footrest - Stainless Steel	1 Pack
B.	1580082-SS	14" Full Round Footrest - Stainless Steel	1 Pack
C.	1580095-SS	Half Round Footrest - Stainless Steel	1 Pack

A: 28" round 2-piece footrest, available as 316 electro polished stainless steel or anodized polished aluminum. Accepts bushings to fit 4", 3-1/2", & 2-7/8" posts. 1" round rail with 1/8" thick vertical spokes.

B: 14" Round 2-piece footrest, available as 316 electro polished stainless steel or anodized polished aluminum. Accepts bushings to fit 2-7/8" & 2-3/8" posts. 1" round rail with 1/8" thick vertical spokes.

C: Half round footrest with mounting collar, available as 316 electro polished stainless steel or anodized polished aluminum. Accepts bushings to fit 4", 3-1/2", & 2-7/8" posts. 1" round rail with 1/8" thick vertical spokes.



Accessories

5 Legged Deck Base

Retail			
Image	Part Number	Description	Pack Quantity
A.	1580550-BLK	5 Legged Deck Base	1 Pack
B.	2100332	Floor Pod	5 Pack
C.	2100340	Locking 75MM Caster	5 Pack

32" diameter 5 legged deck base with mounting plate. Mounting plate is pre drilled with 5/16 x 18 tap to accept any Springfield Marine 12" or 9" round pedestal base.

Approximately 4" high with floor pods or 6" high with casters.



Floor Pod



Locking Caster

Folding Leg

Height	Stainless Steel	Aluminum	Pack Quantity
10-1/4"	1081105-SS	1081105	1 Pack
11-1/2"	1081115-SS	1081115	1 Pack
13-1/2"	1081135-SS	1081135	1 Pack

Rubber stopper to prevent scratching of surfaces. Available in 304 Stainless Steel & Brite Dip Aluminum

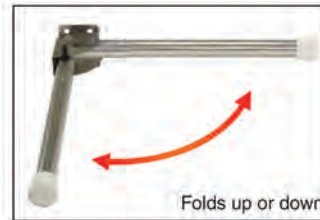

Folds up or down



Deck Plates And Rings

Retail					
Image	Part Number	Description	Diameter	Hole Pattern	Pack Quantity
A.	1580004	Split Under Deck Ring	9"	8"	1 Pack
B.	1580005	Aluminum Deck Plate	12"	11"	1 Pack
B.	1580005-SS	Stainless Steel Deck Plate	12"	11"	1 Pack
C.	1580006	Aluminum Deck Plate	9"	8"	1 Pack
D.	1580007	Aluminum Deck Ring	9"	8"	1 Pack

OEM					
Image	Part Number	Description	Diameter	Hole Pattern	Pack Quantity
A.	3580004	Split Under Deck Ring	9"	8"	10 Bulk
B.	3580005	Aluminum Deck Plate	12"	11"	10 Bulk
C.	3580006	Aluminum Deck Plate	9"	8"	10 Bulk
D.	3580007	Aluminum Deck Ring	9"	8"	10 Bulk
E.	3580012-A	Anodized Deck Plate	12"	8"	10 Bulk
E.	3580012-P	Polished Deck Plate	12"	8"	10 Bulk

Made from non-removable pedestals. 9" deck plates have 8" hole pattern. 12" deck plates have 11" hole pattern (unless noted). Split deck ring requires 4-1/2" hole in deck.



Split Deck Ring



9" Deck Plate



9" Deck Ring



12" Deck Plate



12" Correction Plate

Handle Assemblies & Trac-Lock™ Service Parts

OEM			
Image	Part Number	Description	Pack Quantity
A.	2100028	2-7/8" U-stem Handle Assembly	6 Bulk
B.	2100030	2-Piece Power Pedestal Handle	6 Bulk
C.	2100034	2-3/8" U-Stem Handle Assembly	6 Bulk
D.	2171062	Removable Air-Ride Handle	6 Bulk
E.	2100095	Uni-Lock Trac-Lock™ II Handle	6 Bulk
F.	2100096	Air-Ride Locking Lever For Camlock	6 Bulk
G.	2100033	Trac-Lock™ 2 Seat Mount Handle Assembly	6 Bulk
H.	2171072	Round Handle For Trac-Lock™ III	6 Bulk
I.	2171000	2-3/8" Trac-Lock™ II Swivel Bushing	6 Bulk
J.	2171001	2-7/8" Trac-Lock™ II Swivel Bushing	6 Bulk
K.	2170004	Slide Pads For Trac-Lock™ III	6 Bulk
L.	2171008	2-3/8" Trac-Lock™ III Swivel Bushing	6 Bulk
M.	2171009	2-7/8" Trac-Lock™ III Swivel Bushing	6 Bulk



Replacement handles and assemblies for air-ride pedestals, seat mounts, etc. Replacement and service parts for Trac-Lock™ seat mounts.

Helmsman Footrest

Retail			
Image	Part Number	Description	Pack Quantity
A.	1840054	Stern Handles With Pre Drilled Holes	6 Retail

OEM			
Image	Part Number	Description	Pack Quantity
A.	3840054	Stern Handles w/ Pre Drilled Holes	100 Bulk
B.	3840054-CS	Stern Handles w/ Counter Sunk Holes	100 Bulk
C.	3840054-NH	Stern Handles No Mounting Holes	100 Bulk

High-strength cast aluminum rugged construction. Extra smooth 6" grip. Distance between mounting holes: 6-5/8".

Sold in pairs

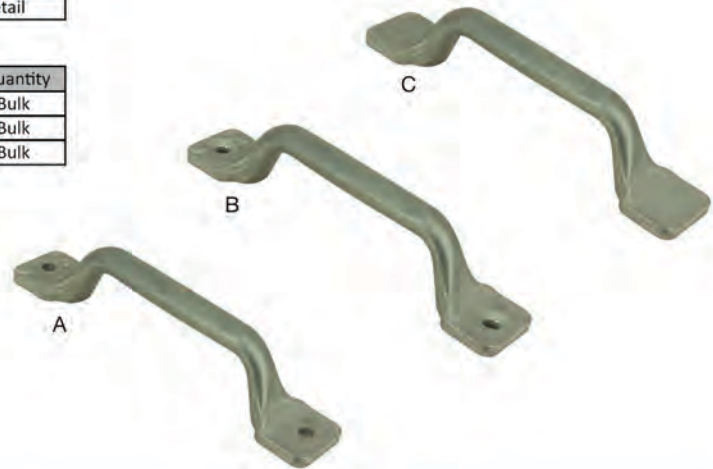

Boat Cleat

OEM			
Image	Part Number	Description	Pack Quantity
A.	3820008	Aluminum Boat Cleat	50 Bulk

Made from heavy-duty extruded aluminum construction for maximum strength and durability.



Oarlock Sockets

Retail				
Image	Part Number	Description	Bushing I.D.	Pack Quantity
A.	1840021	Oarlock Sockets, #20	9/16"	6 Pack

OEM				
Image	Part Number	Description	Bushing I.D.	Pack Quantity
A.	3840020	Oarlock Sockets, #20	9/16"	100 Bulk
A.	3840021	Oarlock Sockets, #30	1/2"	100 Bulk

Round gunwale sockets with plastic inserts. Fits up to 9/16" oarlocks.



Sold in pairs as shown.

Rod Holders

Retail			
Image	Part Number	Description	Pack Quantity
A.	1760004	Fishing Rod Holders	6 Pack

OEM			
Image	Part Number	Description	Pack Quantity
A.	3760004	Fishing Rod Holders	20 Bulk

Holds up to 3 rods. Mounting vertical or horizontal. ABS plastic with foam inserts.

Sold in pairs with bungee cords.



Locking Shelf Hinge

Retail			
Image	Part Number	Description	Pack Quantity
A.	1080030	Stainless Steel Shelf Hinges	1 Pack

90° horizontal locking mechanism. Fold shelf down when not in use. Stainless Steel.

Sold in pairs as shown.

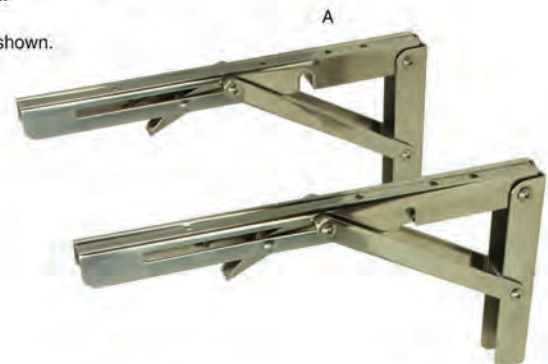

Accessories

Inboard Pop Up Ski Tows

OEM			
Image	Part Number	Description	Pack Quantity
A.	1800090	Pop Up Ski Tow, Inboard, Round Base	1 Pack

Pop Up Ski Tows are designed with the strength to handle most tow sport activities. The single post design conceals neatly away into the deck when not in use and is activated with a single locking feature for easy conversion into ski ready position.

Pops up with just a twist, then is held up with a spring.

- 2-1/2" above deck, and 5-1/4" below deck
- Made from high strength aircraft aluminum
- Anodized finish
- Designed for 2000 lbs static load



Stows flush

Outboard Pop Up Ski Tows

OEM			
Image	Part Number	Description	Pack Quantity
A.	1800095	Pop Up Ski Tow, Outboard, Round Base	1 Pack
B.	1800096	Pop Up Ski Tow, Outboard, Oval Base	1 Pack
C.	1800096-E	Electric Ski Tow, Outboard, Oval Base	1 Pack

Ski Tows are designed with the strength to handle most tow sport activities. The single post design conceals neatly away into the deck when not in use.

- Stows flush with deck
- Made from aircraft grade aluminum
- Designed for 2000 lbs static load

(A. & B.) The Pop Up Ski Tows are activated with a single locking feature for easy conversion into ski ready position. 22" above deck and 37" below deck.

(C.) The Electric Ski Tow tracks up and down on a guid rail, and raises in under 25 seconds, at the press of a switch. 23" above deck and 37.5" below deck.



Pop Up Ski Tow - Oval Base



Pop Up Ski Tow - Round Base



Electric Ski Tow - Oval Base



Ski Tow Pylons

OEM					
Image	Part Number	Description	Above Deck	Overall Length	Pack Quantity
A.	1800039-T	Ski-Tow, Twist In	40"	59"	1 Pack
A.	1800040-T	Low Profile Twist In	40"	59"	1 Pack
B.	1800041-T	Ski-Tow, Twist In	37"	56"	1 Pack
C.	1800061-T	Ski-Tow, Twist In	43"	62"	1 Pack

1-3/4" high-strength aircraft aluminum pylons.
Available in a variety of lengths.
Must have a minimum of 19" below deck.

Special order up to 61" above deck, with struts
available upon request.

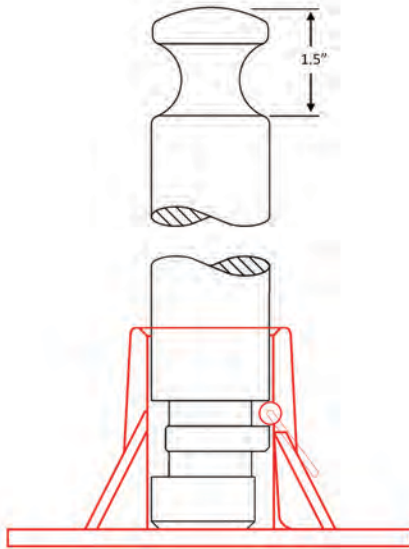

Notched in two points allowing easy drop-in and removal without accessing below the deck.

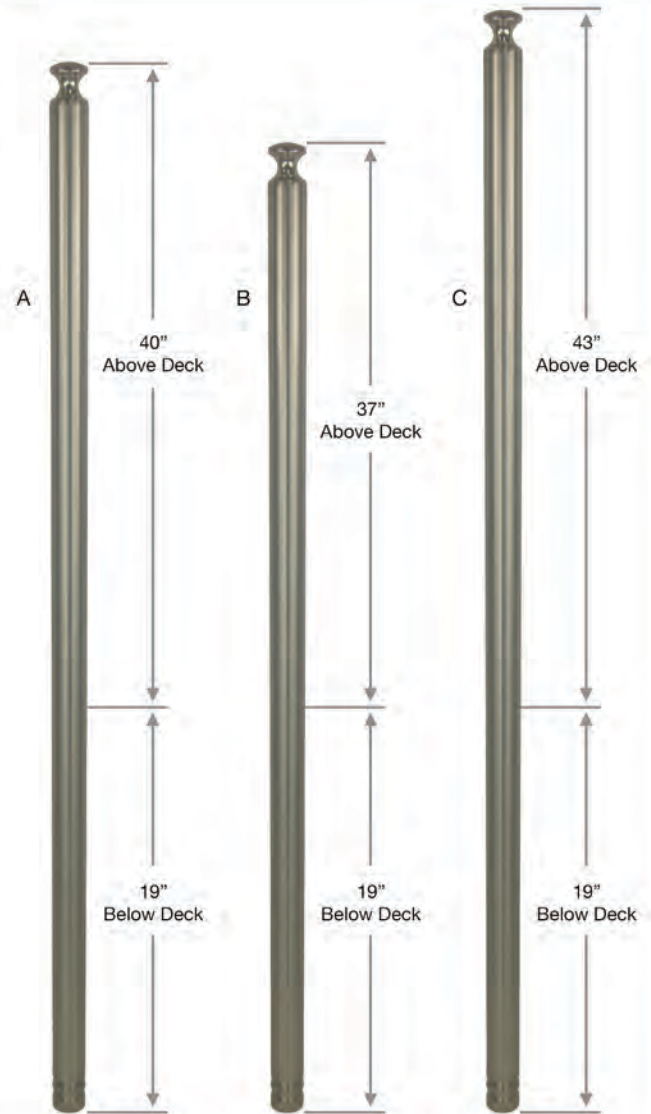

Mounting Receiver & Bases

OEM			
Image	Part Number	Description	Pack Quantity
A.	1800044	Ski Tow Receiver	20 Bulk
B.	1800044-SS	Heavy Duty Low Profile Receiver	20 Bulk
C.	3640032-PP	3-1/2" x 5-1/2" Deck Base	20 Bulk
D.	3640034	4-1/2" x 4-1/2" Deck Base	20 Bulk
E.	3640035	2-Hole Ski Tow Deck Base	20 Bulk
F.	3640036	7" x 7" Ski Tow Deck Base	20 Bulk
G.	3640040	7" x 7" Low Profile Ski Tow Deck Base	20 Bulk

Necessary items for mounting ski tow pylons to your boat.

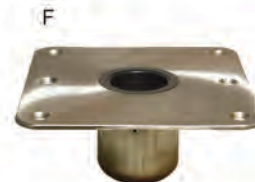

Accessories

Fuel Separator Covers

OEM			
Image	Part Number	Description	Pack Quantity
A.	3760022	Large - Narrow Fuel Separator Cover	10 Bulk
B.	3760025	Small Fuel Separator Cover	10 Bulk
C.	3760027	Small - Narrow Fuel Separator Cover	10 Bulk

- Made from high-strength injection molded polypropylene
- Fitted ribs allow quick snap fit and easy access to fuel filter
- Protects from damage due to impact and sun
- Used for shielding to protect against accidental contact by a tool or the battery terminals during servicing, installation, or removal
- ABYC E-10.7.8 - Each metallic fuel line and fuel system component within 12 inches of the horizontal or vertical plane of the battery surface containing the terminals, as installed, shall be shielded with dielectric material to protect against accidental short-circuiting

Designed for Yamaha:
Above 115 HP

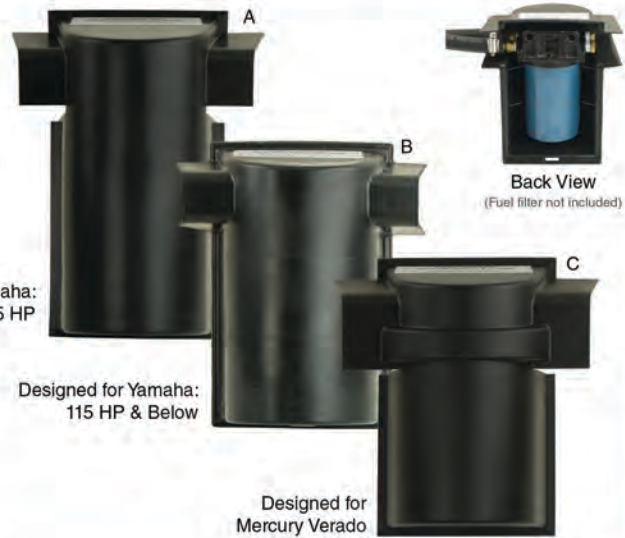

Transom Tuff'ner™

Retail				
Image	Part Number	Description	Size	Pack Quantity
A.	1780203	Heavy-Duty Tuff'ner™	4" x 17"	1 Pack
B.	1780223	Economy Tuff'ner™	2" x 15"	1 Pack

Adds strength and longevity to boats transom by evenly distributing forces during fast starts, high speed runs, and sharp turns. High-strength aluminum. Easy to install using two bolts (not included) 12-15/16" bolt pattern.



Quick Change Trailer Jack

Retail			
Image	Part Number	Description	Pack Quantity
A.	1840046	Trailer Jack, For Wheel Size 10" to 15"	1 Pack
B.	1840047	Trailer Jack Jr. For Wheel Size 8" to 10"	1 Pack

Makes elevating trailer quick, easy, and safe. High-strength aluminum construction. Fits round or square axles. Available in two sizes to fit your needs:

- Trailer Jack -- Lifts up to 2 tons
- Jack Jr. -- Lifts up to 1-1/2" tons



Guardian Motor Support

Retail			
Image	Part Number	Description	Pack Quantity
A.	1780238	Extended, Over The Roller	6 Retail
B.	1780240	Deluxe Combo, Over The Roller & Bolt-On	6 Retail
C.	1780242	Standard Combo, Over The Roller & Bolt-On	6 Retail
D.	1780245	Economy Combo, Over The Roller & Bolt-On	6 Retail

OEM			
Image	Part Number	Description	Pack Quantity
E.	1780230	V Mount, Bolt-On	10 Bulk
F.	1780233	Deluxe, Over The Roller	10 Bulk
A.	3780238	Extended, Over The Roller	10 Bulk

Cast aluminum head with high-strength aluminum shaft.
 Supports the cantilevered weight of the motor.
 Stabilizes engine and steering mechanism when trailering.
 Varying adjustability. Includes 15" black EPDM rubber holding strap.

Available in Bolt-On or Over The Roller strap-on.



Guardian Deluxe Guardian Standard Guardian Economy V-Block



Over The Roller Bolt-On Economy Bolt-On



Adjusts
33" to 53"



Adjusts
25" to 37"



Adjusts
20" to 31-1/2"



Adjusts
21" to 32-1/2"



Fixed Height
25"



Adjusts
25" to 37"

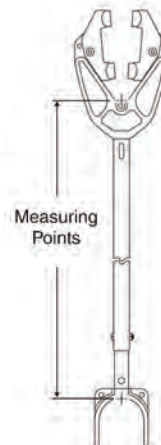

Over The Roller

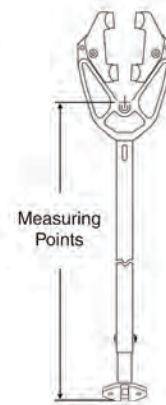

Bolt-On

Accessories

Extend-A-Reach Motor Support

Retail			
Image	Part Number	Description	Pack Quantity
A.	1780250	Extend-A-Reach Support Kit	1 Pack

OEM			
Image	Part Number	Description	Pack Quantity
D.	2100079	Extend-A-Reach Y Bushing	1 Pack

Extend-A-Reach secures the motor to trailer crossbar. Includes all parts necessary for easy installation. Removes easily for quick loading and unloading. Heavy-duty steel with Corrosion resistant e-coat finish. Includes 15" black EPDM rubber holding strap. Adjusts from 26" to 56"



Guardian Replacement Parts

OEM			
Image	Part Number	Description	Pack Quantity
A.	2100067	T-Brace For Bolt-On	6 Bulk
B.	2100073	Bolt-On Clevis Pin	6 Bulk
C.	2100074	Support Bushing Kit	6 Bulk
D.	2100075	Plastic Swivels For Motor Support	6 Bulk

Replacement parts for Guardian Motor Supports.



Bolt-On T-Brace
For Guardian Motor Supports



Bolt-On Clevis Pin
(Secures T-Brace To Motor Support)



Replacement Bushing Kit For
Guardian Motor Support



Replacement Plastic Swivels
For Guardian Motor Support

Part Number	Page
1000202	16
1000205-L	16
1001003	12
1001204-L	17
1001303	23
1001304	23
1001311-NA	23
1001408-L	17
1001414	16
1001414-L	16
1002062	28
1002083	28
1002110	28
1003224	20
100605-L	17
1020003	22
1020004	22
1030200	14
1040002	22
1040211	14
1040212	14
1040212-NS	14
1040213	14
1040213-NS	14
1040214	14
1040215	14
1040216	14
1040216-NS	14
1040217	14
1040219	14
1040224	20
1040350-SL	14
1040351-SL	14
1040352-PIC	14
1040352-PIM	14
1040352-TLM	14
1040353-TLC	14
1040355-KPC	14
1040355-KPM	14
1040357-KPC	14
1040357-KPM	14
1040407	19
1040611	11
1040616	11
1040621	11
1040622	11
1040623	11
1040624	11
1040625	11
1040626	11

Part Number	Page
1040627	11
1040628	11
1040629	11
1040634	10
1040636	10
1040642	10
1040643	10
1040646	10
1040647	10
1040649	10
1040651	11
1040653	11
1040655	11
1040658	11
1040661	10
1040663	10
1040665	10
1040667	10
1040668	10
1040691	12
1040693	12
1040697	12
1040732	20
1040800	21
1040809	22
1040900	21
1041061	06
1041104	101
1041107	101
1041242-C	27
1041602	05
1041603	05
1041606	05
1041620	05
1041631	05
1041633	05
1041635	05
1041636	06
1041731	06
1041733	06
1041883	05
1041819	05
1041800-SF	05
1041983	05
1041919	05
1041900-SF	05
1042010	24
1042010-SF	24
1042030-B2	26
1042046	18

Part Number	Page
1042047	18
1042050	18
1042064	27
1042066	27
1042080-B	26
1042080-W	26
1042081-BC	26
1042093	27
1042110-B	26
1042120-XLB	26
1042140-F	27
1042140-FA	27
1042150-F	27
1042150-FA	27
1042150-PR	27
1042159	27
1042224	27
1042294	27
1042505	22
1043001	18
1043200-SFB	20
1043224	20
1043224-B	20
1043224-CS	20
1043224-SF	20
1043250-SF	19
1043250-SFB	19
1043251	19
1043253	19
1043259	19
1043263	19
1043295	19
1043501	21
1043691	19
1043693	19
1043695	19
1043699	19
1045014	15
1045020	15
1045028	15
1045035	15
1045036	15
1045070	24
1049624	20
1060002-M	15
1060002-S	15
1060004	15
1060100	16
1060204	15
1060204-C	15

Part Number Index

Part Number	Page
1060206-M	15
1060206-S	15
1060407	15
1060407-C	15
1060410-S	15
1060410-M	15
1060605	15
1060605-C	15
1060610-M	15
1060610-S	15
1061014-S	15
1061014-SG	15
1061015-M	07
1061015-MS	07
1061015-S	07
1061015-SB	07
1061015-SG	07
1061015-SW	07
1061016	07
1061017	07
1061018	07
1061019	07
1061020	07
1061021	07
1061025	07
1061045	07
1061057	07
1061065	06
1061067	06
1061069	06
1061071	06
1061075	06
1061077	06
1061079	06
1061100	12
1061100-C	08
1061100-S	08
1061101-C	08
1061101-S	08
1061103-C	08
1061103-S	08
1061104-C	08
1061104-S	08
1061105-C	08
1061105-S	08
1061106-C	08
1061107-C	08
1061108-C	08
1061112-C	08
1061113-C	08

Part Number	Page
1061114-C	08
1061117-C	08
1061121-C	08
1061123-C	08
1061125-C	08
1061201	15
1061201-C	15
1061205-M	15
1061205-S	15
1061301	23
1061302	23
1061311	23
1061403	15
1061405-M	15
1061405-S	15
1062031	09
1062034	09
1062089	09
1062131	09
1062134	09
1062583	09
1071500	79
1071502-L	79
1071502-R	79
1071505-L	79
1071505-R	79
1071524	79
1071542-PRO	79
1071590	79
1080009-M	101
1080013-G	101
1080016-BL	101
1080018	22
1080021	13
1080021-EMB	13
1080021-SS	13
1080022	13
1080026	101
1080026-BL	101
1080027	101
1080027-BLK	101
1080027-OW	101
1080030	105
1080031	101
1080040	101
1080080	24
1080085	24
1080088	24
1080115	78
1080117	78

Part Number	Page
1080121	13
1080136	78
1080136-L1	78
1080160	78
1080165	78
1081105	104
1081105-SS	104
1081115	104
1081115-SS	104
1081135	104
1081135-SS	104
1081224-G	23
1081224-GAL	23
1081230-G	23
1081230-GAL	23
1081233	23
1099050-2	24
1099050-2A	24
1100007	85
1100009	85
1100012	86
1100015	86
1100016	83
1100017	83
1100018	85
1100019	85
1100021-1	68
1100021-L1	50, 68
1100031-1	42, 47, 52, 64
1100031-L1	42, 47, 64
1100050	86
1100050-L	86
1100115	86
1100300	82
1100318	85
1100319	85
1100360	81
1100521-1	69
1100521-L1	69
1100531-1	64
1100531-L1	64
1100550-L	86
1100930-A1	68
1104010	86
1240006-DAL	71
1240006-DPL	71
1240006-DSL	71
1240006-MAL	71
1240006-MPL	71
1240006-MSL	71

Part Number	Page
1240006-SAL	71
1240007-MAL	71
1240008-MAL	71
1240008-MSL	71
1240008-SAL	71
1240009-DAL	71
1240009-MAL	71
1240010-MAL	71
1240010-MSL	71
1240010-SAL	71
1240011-MAL	71
1240012-DAL	71
1240012-DPL	71
1240012-DSL	71
1240012-MAL	71
1240012-MPL	71
1240012-MSL	71
1240012-SAL	71
1240014-DAL	71
1240014-DPL	71
1240014-DSL	71
1240014-MAL	71
1240014-MPL	71
1240014-MSL	71
1240015-SAL	71
1240018-DAL	71
1240018-DPL	71
1240018-DSL	71
1240018-MAL	71
1240018-MPL	71
1240018-MSL	71
1240018-SAL	71
1240020-DAL	71
1240020-DPL	71
1240020-DSL	71
1240020-MAL	71
1240020-MPL	71
1240020-MSL	71
1240020-SAL	71
1240024-DAL	71
1240024-DPL	71
1240024-DSL	71
1240024-MAL	71
1240024-MPL	71
1240024-MSL	71
1240024-SAL	71
1240206-MPL	71
1240509-MAL	71
1240512-MAL	71
1240609-L	67

Part Number	Page
1240616	67
1240616-L	67
1240629	67
1240629-L	67
1240639	67
1240716-L	67
1240720-L	67
1240729-L	67
1240739-L	67
1240748-MLNS	70
1240749-LNS	70
1240749-MLNS	70
1240750-LNS	70
1240750-MLNS	70
1240752-MLNS	70
1250100	61
1250100-L	61
1250100-L1	61
1250150-L	61
1250150-L1	61
1250200-L	61
1250200-L1	61
1250206-L	61
1250250-L	61
1250250-L1	61
1250250-LC	61
1250252-L	62
1250252-LC	62
1250253-L	62
1250254-L	62
1250256-L	61
1250260-L	62
1250300	67
1250301	67
1250307-MLNS	65
1250308-MLNS	65
1250309	63
1250309-L	63
1250309-LNS	65
1250309-MLNS	65
1250309-NS	65
1250310-LNS	65
1250310-MLNS	65
1250311-MLNS	65
1250312	63
1250312-L	63
1250312-LNS	65
1250312-MLNS	65
1250313-L	63
1250313-LNS	65

Part Number	Page
1250315	63
1250315-L	63
1250315-LNS	65
1250321	67
1250321-NS	70
1250326-NS	70
1250328-NS	70
1250349-L	63
1250351-L	63
1250353-L	63
1250356-LC2	67
1250400	62
1250401	62
1250450-L	67
1250456-L	67
1250470-LC	67
1250533	67
1250534-MLNS	71
1250535	67
1250535-L	67
1250535-MLNS	71
1250540	67
1250540-L	67
1250545-L	67
1250550	67
1250550-L	67
1252140	29
1253031-L	62
1253031-MNS	62
1253032-L	62
1253032-L1	62
1255595-NC	30
1260012	68
1260018	68
1260024	68
1260606-DAL	72
1260606-DSL	72
1260607-MAL	72
1260608-DAL	72
1260608-DSL	72
1260610-DAL	72
1260610-DSL	72
1260612-DAL	72
1260612-DSL	72
1260615-DAL	72
1260615-DSL	72
1270340-P	76
1270346-P	76
1270350-P	76
1270354-P	76

Part Number Index

Part Number	Page
1270370-W	76
1270640-SS	75
1270646-SS	75
1270650-SS	75
1270676-SS	75
1271333-PE	74
1271334-PE	74
1271340-PE	74
1271349-PE	74
1271640-SSE	74
1271649-SSE	74
1275580-NC	30
1276548	29
1280104-MAL	72
1280104-MALC	72
1280104-MPL	72
1280104-SAL	72
1280106-MAL	72
1280106-MPL	72
1280106-SAL	72
1280107-MAL	72
1280107-MALC	72
1280108-MAL	72
1280108-MALC	72
1280108-MPL	72
1280109-MAL	72
1280109-MALC	72
1280110-MAL	72
1280110-MALC	72
1280111-MALW	72
1280618-SS	70
1280624-SS	70
1300601	47
1300601-AP	47
1300709	48
1300709-HL1	46
1300709-L1	46
1300712	48
1300712-HL1	46
1300712-L1	46
1300713	48
1300715	48
1300715-HL1	46
1300715-L1	46
1300750-1	49
1300750-A1	49
1300750-L1	49
1300750-R1	49
1300751-1	49
1300754-1	49

Part Number	Page
1300901	46
1300902	46
1301037	46
1301038	46
1304012-HL	48
1304015-HL	48
1312701	47
1440007-SAL	65
1440010-DSL	65
1440013-SAL	65
1440015-SAL	65
1440213	63
1440213-L	63
1440220	63
1440220-L	63
1440228	63
1440248	87
1440334	63
1440607-MAL	65
1440609-MAL	65
1440610-MAL	65
1440612-MAL	65
1440613-MAL	65
1440615-MAL	65
1450012-P	76
1450014-P	76
1450018-P	76
1450022-P	76
1450024-P	76
1450028-P	76
1450030-P	76
1450615-SSP	76
1450626-SSP	76
1450630-SSP	76
1455580-NC	30
1457545	29
1561105	87
1561106	87
1561107	87
1580004	104
1580005	104
1580005-SS	104
1580006	104
1580007	104
1580010	79
1580017	103
1580017-BLK	103
1580021-BLK	103
1580022	103
1580022-BLK	103

Part Number	Page
1580030	102
1580040	103
1580045	103
1580048	103
1580074	102
1580080-AL	103
1580080-SS	103
1580082-AL	103
1580082-SS	103
1580095-AL	103
1580095-SS	103
1580550-BLK	104
1600003	44
1600005	44
1600008	44
1600010	44
1600205	43
1600406	43
1600409	43
1600420	41
1600607	41
1600607-L	41
1600610	43
1600611	43
1601002-L	41
1601037	42
1602016	41
1603824	42
1603825	42
1610411-A	36
1610411-EC	36
1610413-A	36
1610413-EC	36
1610413-OSS	37
1610415-A	36
1610425-A	36
1611433	34
1612401-A	33
1612402-A	33
1613401-EC	35
1613402-A	35
1614201-PP	35
1615201-EC	35
1615204-EC	35, 52
1615207-ECB	52
1615254-EC	34
1615431-1	33
1615433-1	33
1620001	37
1620003	37

Part Number	Page
1620004	37
1620005	37
1620016	39
1620017	39
1620017-S	39
1630001	38
1630001-P	38
1630003	38
1630004	38
1630401-1	33
1630402-A	36
1630402-CSS	37
1630402-EC	36
1630411-A	36
1630415-A	36
1630423-A	36
1630801-A	35
1630801-EC	35
1631037	34
1632012-A	33
1632013-A	33
1640002	58
1640007-CL	58
1640012-PASSCL	58
1640013-CL	58
1640202	56
1640203	56
1640401	57
1640403	57
1640404	57
1640425	57
1641009	55
1641019	55
1641037	56
1641508	55
1642005	55
1642008	55
1643013	56
1644513-S	55
1660001	96
1660003	96
1660004	95
1660012	94
1660017	96
1660018	95
1660024-A	96
1660029	94
1660029-L	94
1660030-A	96
1660032-A	96

Part Number	Page
1660037-A	96
1660230	92
1660230-BLK	92
1660231	92
1660232	92
1660232-KP	92
1660250	91
1660250-EC	91
1660701	97
1660702	97
1660703	97
1660704-L	97
1661127-CAL	98
1661624	98
1661624-P	98
1662127	99
1670002	90
1670002-U	90
1670006	90
1670006-U	90
1670008	90
1670009	90
1680203	56
1680409	57
1680411	57
1680415	57
1680418	57
1690001-SL	94
1690102	91
1690106	91
1690107	91
1690202	91
1690206	91
1690207	91
1690727-SL	93
1690901	90
1692027-L	93
1760004	105
1780010	86
1780203	108
1780223	108
1780230	109
1780233	109
1780238	109
1780240	109
1780242	109
1780245	109
1780250	110
1793113	52
1793313	52

Part Number	Page
1800039-T	107
1800040-T	107
1800041-T	107
1800044	107
1800044-SS	107
1800061-T	107
1800090	106
1800095	106
1800096	106
1800096-E	106
1840021	105
1840046	108
1840047	108
1840054	105
1840220	84
1940049	89
1940052	89
1940054	89
1940057	89
1940059	89
2100010	59
2100011	59
2100012	59
2100013	59
2100025	99
2100026	39
2100030	104
2100031	44
2100032	39
2100033	104
2100034	104
2100038	59
2100038-SS	59
2100040	59
2100055	39
2100067	110
2100073	110
2100074	110
2100075	110
2100077	39
2100079	110
2100091	59
2100091-B	59
2100092	53, 99
2100092-B	53, 99
2100093	99
2100093-B	99
2100094	39
2100095	104
2100096	104

Part Number Index

Part Number	Page
2100097	86
2100099	104
2100104	99
2100115	99
2100145	89
2100146	89
2100148	89
2100149	89
2100151	89
2100175	39
2100184	89
2100300	13
2100332	104
2100340	104
2170004	104
2171000	104
2171001	104
2171003	44
2171004	44
2171008	104
2171009	104
21710095-BLK	103
2171032	44
2171040	103
2171041	103
2171042	103
2171044	103
2171062	104
2171072	104
3042045	102
3100007	85
3100009	85
3100015	86
3100017	83
3100018	85
3100019	85
3100021-1	68
3100021-CR1	68
3100021-L1	50, 68
3100021-LAR1	68
3100031-1	42, 47, 52, 64
3100031-L1	42, 47, 64
3100031-LAR1	64
3100036-BLK	83
3100038-BLK	83
3100039	83
3100045	82
3100050	86
3100065-L	74
3100065-LAR	74

Part Number	Page
3100075-L	75
3100075-LAR	75
3100202	83
3100205	84
3100205-M	84
3100207	83
3100300	82
3100318	85
3100319	85
3100360	81
3100360-EXTL	81
3100401	81
3100460-LE1	75
3100521-1	69
3100521-CL1	69
3100521-EL1	69
3100521-L1	69
3100521-LAR1	69
3100521-LE1	69
3100521-LL1	69
3100521-LLL1	69
3100531-1	64
3100531-L1	64
3100531-LAR1	64
3100534-L	84
3100534-L3M	84
3100534-LSH	84
3100534-S	84
3100545	82
3100545-EW	82
3100545-W	82
3100548	84
3100550-SS	76
3100565-L	74
3100565-LA	74
3100565-LAE	74
3100565-LAR	74
3100565-LARA	74
3100565-LARW	74
3100565-LW	74
3100571-S	81
3100575-L	75
3100575-LAR	75
3100575-LARW	75
3100646	82
3100656	82
3100930-A1	68
3101521-GLAR	69
3101521-L	69
3101521-LAR	69

Part Number	Page
3101521-LARW	69
3101521-LC	69
3101521-LW	69
3101545-EW	82
3300601	47
3300601-AP	47
3300709	48
3300709-HL	48
3300710	48
3300712	48
3300712-HL	48
3300713	48
3300713-HL	48
3300714	48
3300715	48
3300715-HL	48
3300728	48
3300750-1	49
3300750-A1	49
3300750-AR1	49
3300750-D1	49
3300750-L1	49
3300750-R1	49
3300751-1	49
3300751-A1	49
3300752-CR1	49
3300752-D	49
3300753-1	49
3300753-K1	49
3300754-1	49
3300757-D1	49
3300758-1	49
3300759-PP1	49
3300760	50
3300762	50
3300764-PP1	49
3300766	50
3300767	50
3300850-A1	50
3300900	46
3300901	46
3300902-AS	46
3301750-1	49
3301809	50
3301812	50
3301816	50
3301818	50
3310708-L	48
3310709-L	48
3310712-L	48

Part Number	Page
3310714-L	48
3310715-L	48
3312701	47
3580004	104
3580005	104
3580006	104
3580007	104
3580012-A	104
3580012-P	104
3600002-A	44
3600003	44
3600005	44
3600008	44
3600010	44
3600406	43
3600409	43
3600413	43
3600610	43
3600610-LD	43
3601002	41
3601002-L	41
3601011	41
3605205-EC	43
3610411-A	36
3610411-EC	36
3610411-P	36
3610413-A	36
3610413-EC	36
3610413-OSS	37
3610413-P	36
3610413-PSS	36
3610415-A	36
3610415-P	36
3610425-A	36
3610425-EC	36
3610425-P	36
3611431-A	34
3612401-A	33
3612402-A	33
3613401-EC	35
3613402-A	35
3614201-PP	35
3614204-PP	35
3615201-EC	35
3615204-EC	35, 52
3615207-ECB	35, 52
3615254-EC	34
3620001	37
3620001-P	37
3620003	37

Part Number	Page
3620004	37
3620005	37
3620005-P	37
3620011	37
3620016	39
3620017	39
3620018	37
3620024	39
3620025	39
3620760	39
3630001	38
3630003	38
3630004	38
3630004-BLK	38
3630004-EC	38
3630005	38
3630005-P	38
3630018	38
3630019	38
3630020	38
3630020-OS	38
3630024	39
3630402-A	36
3630402-CSS	37
3630402-EC	36
3630402-P	36
3630402-PSS	36
3630411-A	36
3630413-SS	36
3630414-A	36
3630414-EC	36
3630423-A	36
3630423-P	36
3630801-A	35
3630801-EC	35
3631012-PSS	33
3631013-PSS	33
3632012-A	33
3632013-A	33
3632013-EC	33
3633011-SSA	34
3633013-A	34
3633013-SSA	34
3640002	58
3640002-CLA	58
3640007-CL	58
3640012-CL	58
3640012-PASSCL	58
3640013-CL	58
3640021-CL	58

Part Number	Page
3640022-PPCL	58
3640023	59
3640024-CL	58
3640025-CL	58
3640026-CL	58
3640032-PP	107
3640034	107
3640035	107
3640036	107
3640040	107
3640202	56
3640203	56
3640401	57
3640411	57
3640413	57
3640415	57
3640420	57
3640425	57
3640511-S	57
3640513-A	57
3641007	55
3641013	55
3641507	55
3642507-BAS	55
3660002	96
3660003	96
3660004	95
3660004-BLK	95
3660004-SM	95
3660017	96
3660017-BLK	96
3660018	95
3660023	95
3660024-A	96
3660026-A	96
3660026-P	96
3660030-A	96
3660032-A	96
3660032-P	96
3660037-A	96
3660107	98
3660127-CAL	98
3660127-CPL	98
3660207	98
3660324	96
3660325	96
3660327	96
3660328	96
3660330	96
3660525	95

Part Number Index

Part Number	Page	Part Number	Page	Part Number	Page
3660527	95	3690001-BLKL	94	3793012-P	53
3660703	97	3690001-SL	94	3793013-A	53
3660704-L	97	3690007	99	3793014-P	53
3660727	97	3690007-A	99	3793211	53
3660727-L2	97	3690007-P	99	3793212	53
3662027	99	3691014-L	93	3793213	53
3662027-P	99	3691027	93	3796009-SL	53
3663027	99	3691027-CPL	93	3796010-AL	53
3664230-RV	98	3691027-L	93	3796010-PL	53
3664250-RV	98	3691028-L	93	3796010-SL	53
3664275-RV	98	3692027-CPL	93	3820008	105
3664300-RV	98	3692027-L	93	3840020	105
3680007-CL	59	3692027-LU	93	3840021	105
3680012-CL	59	3692029-L	93	3840054	105
3680012-PASSCL	59	3692128	93	3840054-CS	105
3680013-CL	59	3692700	94	3840054-NH	105
3680203	56	3760004	105	3840220	84
3680409	57	3760022	108	7100170-W	90, 99
3680411	57	3760025	108		
3680412	57	3760027	108		
3680413	57	3760060	102		
3680415	57	3760063	102		
3680418	57	3760067	102		
3690001	94	3780238	109		
3690001-AL	94	3793012-A	53		

The entire content of this catalog, including but not limited to images, text, code, materials and other components or elements herein are copyrighted materials owned by Springfield Marine or other third parties, and are protected by United States, worldwide copyright and trademark laws and treaty provisions. Therefore, you may not use, copy, reproduce, publish, modify, transmit, upload or distribute the contents or elements of this catalog in any way without Springfield Marine's express prior written permission. This catalog may be used for informational purposes, online ordering of products, creating and accessing Springfield Marine's user accounts; but, may not be used to commercialize or market any product or service without our express written permission. Permission is granted to electronically copy and print hard copy portions of this catalog for the sole purpose of placing an order with the Springfield Marine website and/or user account; thus, solely for your own non-commercial use. Except as expressly provided herein, Springfield Marine does not grant to users or individuals who access this catalog any express or implied rights under any patents, copyright, trademarks, or trade secrets. Copy of any portion of this catalog thereof must be maintained in an unchanged fashion, include the copyright notices as it appears on this catalog.

All rights are hereby expressly reserved.

KingPin™
Taper-Lock™
Plug-In™
Thread-Lock™
Spring-Lock™
Accessories

SPRINGFIELD MARINE'S
Color Coding System

Our Color-Coded Packaging System
 simplifies your search for the right item to fit your boat.
 Simply match the parts according to the color of your
 product series to ensure proper fit.



Springfield Marine Company

is a proud member of these associations and subscribe to the standards and practices which they set forth.



About ABYC H-31 Classifications And Safety Standards

The American Boat and Yacht Council (ABYC) has recommended marine industry seating standards for pedestal applications into two separate categories as follows:

- Class A** Seat designed for occupancy while the boat is underway at any speed.
- Class B** Seat designed for occupancy only at boat speeds not exceeding five miles per hour (fishing or trolling).

All pedestals must pass a series of tests within each of these classifications which include horizontal and vertical impacts, torque, static load, fatigue, and fastener pull testing.

There are two types of class A seats:

- Class AP - Passenger** Seat mount must resist 30 foot pounds of torque (non-locking).
- Class AD - Driver** Seat mount must incorporate a "mechanical interference lock" and resist 150 foot pounds of torque (locking).

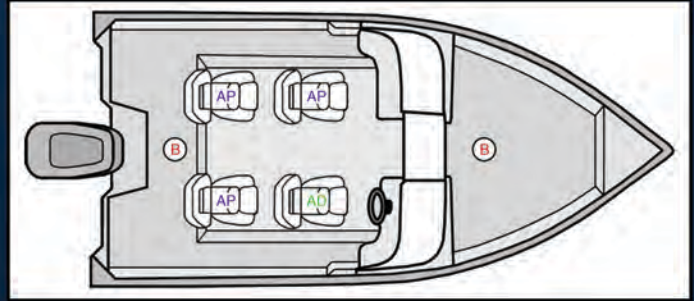

CLASS B



CLASS AP



CLASS AD

Look for these labels to identify the ABYC H-31 Classifications

Springfield Marine Company has been a leader in establishing and complying with these ABYC recommended standards.

IN ORDER TO COMPLY WITH THESE STANDARDS, SPRINGFIELD COMPONENTS MUST BE COMBINED WITH OTHER SPRINGFIELD PARTS. MIXING SPRINGFIELD PARTS WITH NON-SPRINGFIELD COMPONENTS VOIDS THESE STANDARD CLASSIFICATIONS.

Removable Passenger
Plug-In™ Package

Premium Skipper Seat

CLASS AP
ABYC CLASS H-31 PASSENGER AP

Camlock Slide & Regatta Pedestal

Main Passenger
Sport Bucket Seat

CLASS AP
ABYC CLASS H-31 PASSENGER AP

Fishing
Plug-In™ Control Post

CLASS B
ABYC CLASS H-31 FISHING ONLY B

Fishing
Sit Down Pedestal

Skipper Seat

CLASS B
ABYC CLASS H-31 FISHING ONLY B

Locking Mainstay Adjustable Pedestal

Driver
Sport Bucket Flip Up Seat

CLASS AD
ABYC CLASS H-31 DRIVER AD

ABYC H-31

Example of multiple parts on typical model boat

SPRINGFIELD MARINE
YOUR FIRST CHOICE FOR MARINE SEATING PRODUCTS



MARINER • WORKHORSE • MAINSTAY • SECOND GENERATION • SCHOONER • REGATTA • EXPLORER • CLIPPER • SCHOONER
REGATTA • EXPLORER • CLIPPER • SCHOONER • FOLDING SEATS • STAND-UP SEATS • MOLDED SEATS • UPHOLSTERED SEATS
E • MAINSTAY • SECOND GENERATION • SCHOONER • REGATTA • EXPLORER • CLIPPER • SCHOONER • FOLDING SEATS • STA
• STAND-UP SEATS • MOLDED SEATS • UPHOLSTERED SEATS • HELM SEATS • KINGPIN™ • TAPER-LOCK™ • PLUG-IN™ • THREA
AD-LOCK™ • SPRING-LOCK™ • 2-3/8" SERIES • 2-7/8" SERIES • 4" SERIES • WAVE DAMPENING • MOUNTING SYSTEMS • BARBEC
" SERIES • WAVE DAMPENING • MOUNTING SYSTEMS • TABLE SYSTEMS • ACCESSORIES • TRAC-LOCK™ •
• SCHOONER • REGATTA • EXPLORER • CLIPPER • FOLDING SEATS • STAND-UP SEATS • MOLDED SEATS • UPH
UPHOLSTERED SEATS • HELM SEATS • KINGPIN™ • TAPER-LOCK™ • SPRING-LOCK™ • 2-3/8" SERIE
™ • SPRING-LOCK™ • 2-3/8" SERIES • 2-7/8" SERIES • 4" SERIES • WAVE DAMPENING • MOUNTING SYSTEMS • BARBECUE GRILL
FOLDING SEATS • STAND-UP SEATS • MOLDED SEATS • UPHOLSTERED SEATS • HELM SEATS • KINGPIN™ • TAPER-LOCK™ • PLUG
E • MAINSTAY • SECOND GENERATION • SCHOONER • REGATTA • EXPLORER • CLIPPER • SCHOONER • FOLDING SEATS • STA
• STAND-UP SEATS • MOLDED SEATS • UPHOLSTERED SEATS • HELM SEATS • KINGPIN™ • TAPER-LOCK™ • PLUG-IN™ • THREA
AD-LOCK™ • SPRING-LOCK™ • 2-3/8" SERIES • 2-7/8" SERIES • 4" SERIES • WAVE DAMPENING • MOUNTING SYSTEMS • BARBEC
" SERIES • WAVE DAMPENING • MOUNTING SYSTEMS • TABLE SYSTEMS • ACCESSORIES • TRAC-LOCK™ •
• SCHOONER • REGATTA • EXPLORER • CLIPPER • FOLDING SEATS • STAND-UP SEATS • MOLDED SEATS • UPH
UPHOLSTERED SEATS • HELM SEATS • KINGPIN™ • TAPER-LOCK™ • SPRING-LOCK™ • 2-3/8" SERIE
™ • SPRING-LOCK™ • 2-3/8" SERIES • 2-7/8" SERIES • 4" SERIES • WAVE DAMPENING • MOUNTING SYSTEMS • BARBECUE GRILL
FOLDING SEATS • STAND-UP SEATS • MOLDED SEATS • UPHOLSTERED SEATS • HELM SEATS • KINGPIN™ • TAPER-LOCK™ • PLUG



SPRINGFIELD MARINE

1093 N. Cynthia Drive Suite 1 Nixa, Mo 65714
Phone: (417) 725-2667 | Fax: (417) 724-9035
www.springfieldgrp.com