



Marine Catalog

- Rub Rail
- Trim & Moulding
- Hinges & Latches
- Marine Fabrication
- Sport Fishing
- Pedestal Systems
- Marine Accessories

TACO Metals

Celebrating Over 50 Years of Innovation, Quality & Supply Chain Management

Founded in 1959, TACO Metals has become a global leader in the recreational marine industry as the most trusted source for rub rail, pipe and tubing, sport fishing products, specialty marine hardware and seat and table pedestal systems. TACO designs, engineers and manufactures more than 1,000 marine products through a global network developed over the past five decades. The Miami-based company has established a reputation for innovation, quality and supply chain partnering at the highest level. Boat builders, marine accessory manufacturers, dealers, distributors and retailers know they can rely on TACO for premium products, distribution expertise and unsurpassed customer support.

TACO is known for its new product development, design and manufacturing. Utilizing the latest tools, TACO's sales and engineering teams work closely with customers to create solutions that provide best total value, enhanced product performance and uncompromising quality. TACO's new modern manufacturing facility in Sparta, Tennessee is centrally located to service most customers within one day. TACO's regional distribution centers provide inventory management programs and just-in-time delivery for an unparalleled service experience from start to finish.

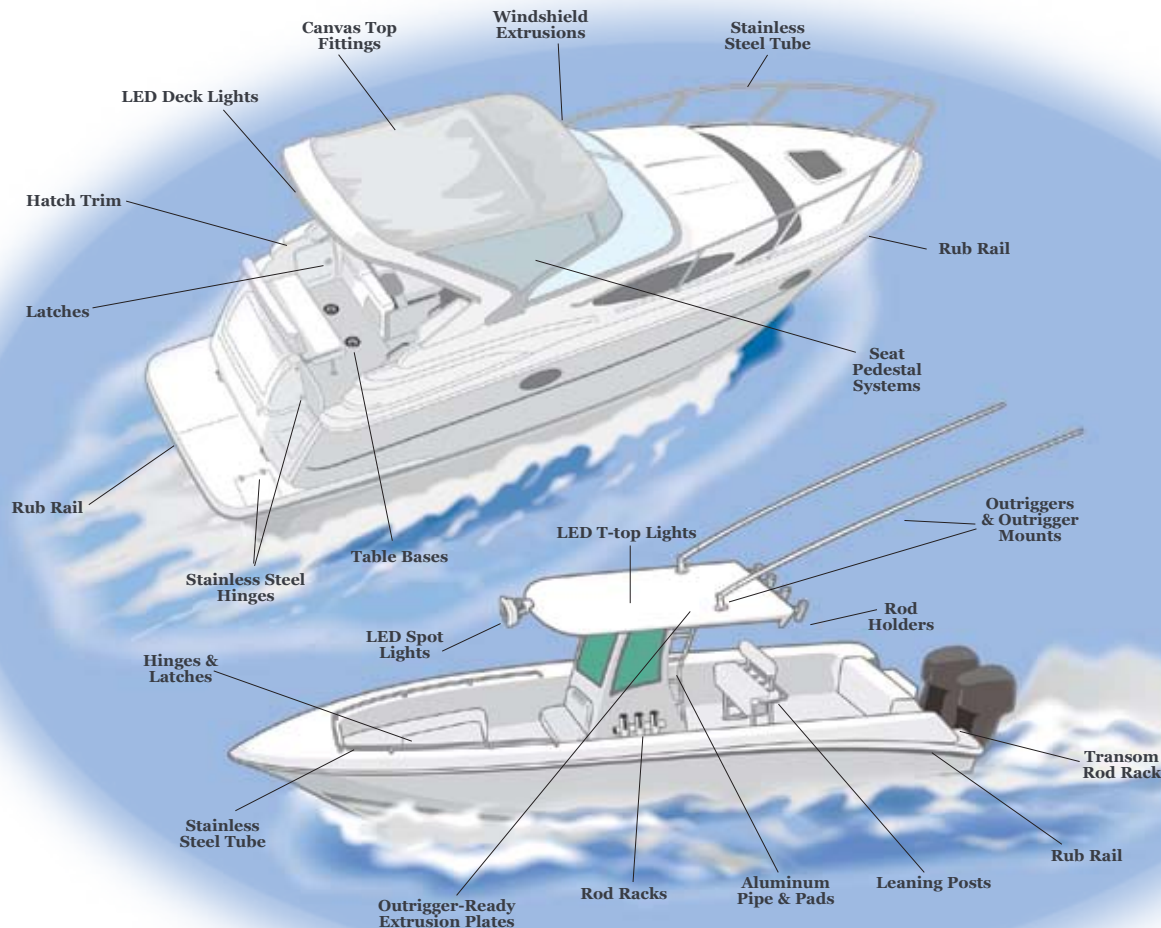

TACOmarine.com

Visit the TACO Marine web site for product specifications, installation and technical product information, project design templates and more.

TABLE OF CONTENTS

RUB RAIL	2
• Rigid Vinyl • Semi-Rigid Vinyl • Stainless Steel • Flexible Vinyl • Kits • Aluminum • Inserts • Accessories	
TRIM & MOULDING	22
• Vinyl • Aluminum • Stainless Steel • Frames • Track Hardware • Seals	
HINGES & LATCHES	30
• Continuous Hinges • Utility Hinges • Specialty Hinges • Hatches • Lifting Handles LATCH-tite™ • Specialty Hardware	
MARINE FABRICATION	40
• Pipe & Tube • T-top & Tower • Wake Towers • Rod Storage • Accessory-Ready™ • Shades & T-tops • Leaning Posts • Bimini & Canvas Tops • Railing	
SPORT FISHING	68
• Outrigger Mounts & Kits • Center Riggers • Outriggers & Accessories • Rigging Kits • Mounting Plates • Rod Holders • Rod Storage	
PEDESTAL SYSTEMS	80
• Poseidon Seat Pedestal Systems • Adjustable Seat Pedestal Systems • Triton 3-Stage Table Pedestal System • Table Pedestal Systems • Seats & Accessories	
MARINE ACCESSORIES	90
• LED Marine Lights • Filet Tables • Poly Accessories • Accessory-Ready™ Poly Accessories • Dock & Trailer Accessories • Marine Lumber	
REFERENCE & SELECTION GUIDES	100
• Metric & Fraction Conversion Chart • International Pipe Standard (I.P.S.) • Rod Holder Selection Guide • Color & Finish Reference • Terms & Conditions • Warranty Information	
INDEX	106



TACOMarine.com

Call 800.226.8201 Boat Builders & Accessory Manufacturers

Call 800.653.8568 Aftermarket Distributors

Rub Rail

Trim & Moulding

Hinges & Latches

Marine Fabrication

Sport Fishing

Pedestal Systems

Marine Accessories

Rail

Rub



TACO METALS Rub Rail has long been the choice of professional boat builders worldwide for its superior design and quality. TACO supplies rub rail for boats 13 feet and up, including fishing boats, cruisers, cuddy cabins, ski boats, pontoon boats and sailboats. You name it and TACO has a rub rail product to fit the need.

QUALITY MATERIALS

TACO uses the finest high-grade materials for in-house vinyl extrusion. Prime virgin resins, compounded with UV inhibitors, plasticizers, fungicides and impact modifiers are used to ensure outstanding weather-ability and optimum performance.

VINYL CO-EXTRUSION

TACO's in-house vinyl extrusion operations continue to expand. The addition of co-extrusion lines has allowed TACO to offer a selection of innovative rub rail products that offer savings in time and labor without sacrificing appearance or performance.

WEATHER SEAL RUB RAIL

TACO offers rigid vinyl rub rail with a flexible vinyl inlay, co-extruded and drilled in-line. These innovative Weather Seal rub rails seal out water and eliminate the need for secondary caulking. As a result boat builders enjoy a savings in material and labor costs.

FLEXIBLE VINYL CHROME INSERTS

TACO also offers co-extruded vinyl inserts that combine the elegant look of stainless steel with the advantages of flexible vinyl. TACO extrudes flexible vinyl, and a specially-formulated chrome mylar that is applied and laminated in-line to the surface of flexible vinyl rub rail. The result is a flexible vinyl insert with the elegant look of stainless steel. Supplied in a continuous coil, the insert is easy to handle and store and installs without fasteners for a one piece smooth and seamless appearance.

TACO STOCKING INVENTORY PROGRAM

All rub rails featured in this catalog are a part of TACO's industry-leading stocking program offering competitive pricing, a wide assortment of product, and stocked inventory to ensure ready availability.

CUSTOM REQUIREMENTS

To meet custom requirements, TACO's rub rail experts work closely with customers to design and engineer exclusive profiles for new boat designs. Open dies are also available for production runs in custom colors and lengths as needed to meet specific requirements. Contact your TACO representative to discuss your custom requirements.



3	Rigid Vinyl
10	Semi-Rigid Vinyl
11	Stainless Steel
13	Flexible Vinyl
14	Rub Rail Kits
16	Aluminum
18	Inserts
20	End Caps
21	Accessories



Rigid Vinyl

- Exceptionally tough, durable and long-lasting even in the most adverse conditions
- Color and gloss levels are carefully matched to blend with hull and deck
- Heat required for radius forming
- Cuts and drills like wood

FEATURE PRODUCT

Rigid Vinyl with Flexible Vinyl Chrome Insert



Now available with select rigid and semi-rigid rub rail, TACO introduces a line of flexible vinyl chrome inserts that offer the elegant look of stainless while maintaining the easy-handling, flexibility and cost savings of flexible vinyls.

Flexible inserts install without fasteners for a clean smooth look.

For more information about these specially formulated, co-extruded flexible vinyl inserts, please see Flexible Vinyl Chrome Insert, page RR18.

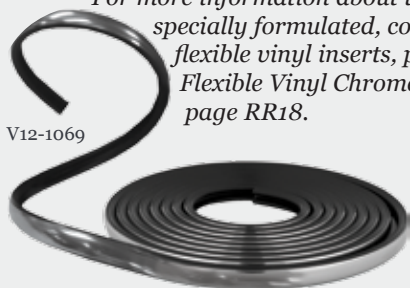

V12-1069



V21-9662



Rigid Vinyl with Flexible Chrome Insert

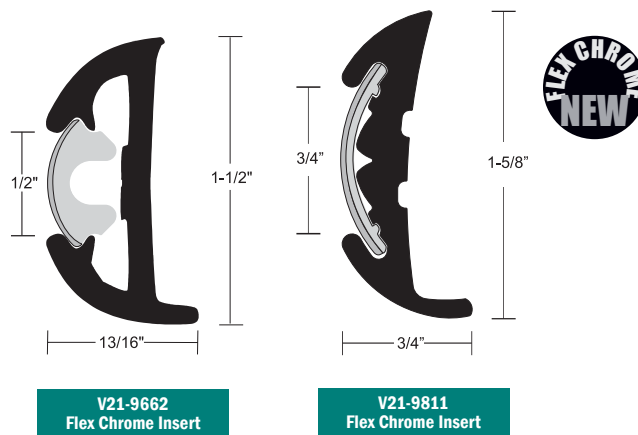

Bulk	Length	Height	Width	Color	Screw	Insert	End Cap
V21-9662BKA20D	20'	1-1/2"	13/16"	Black	#8▼	V12-1069	F16-0039
V21-9662WHC20D	20'	1-1/2"	13/16"	Frosty White	#8▼	V12-1069	F16-0039
V21-9811WHC20D	20'	1-5/8"	3/4"	Frosty White	#8*	V12-9809	-

*Drilled and countersunk on 6" centers ▼Drilled and countersunk on 8" centers

Please refer to page REF101 for color and finish information

Call 800.226.8201 Boat Builders & Accessory Manufacturers
 Call 800.653.8568 Aftermarket Distributors
 TACOMarine.com



FEATURE PRODUCT

Co-Extruded Rigid & Flexible Vinyl Rub Rail



TACO offers a line of co-extruded rub rails that feature a primary rigid vinyl rub rail with flexible vinyl inlays. These unique rub rail products seal and protect, offering time and cost savings.

The flexible vinyl performs as a seal to prevent water from getting behind the rail, eliminating the need for caulking during rub rail installation. In addition to time and cost savings associated with the elimination of caulking, the typical yellowing and peeling seen with aging caulk is also eliminated. These inlays also help to absorb the initial impact felt when the boat hits the dock or pylon, protecting the gel-coat from cracking.

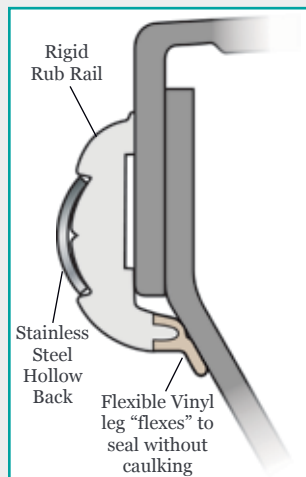
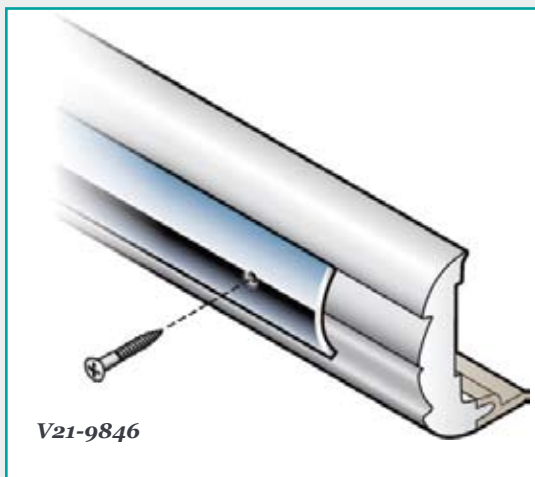

Co-Extruded Rigid Vinyl with flexible vinyl leg adapts to hull contour minimizing the need for caulking.

Co-Extruded Rigid Accepts Stainless Steel

- Drilled and countersunk on 6" centers

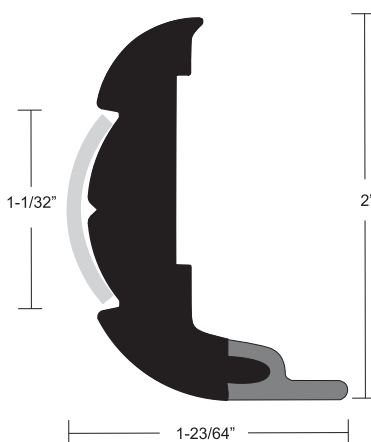

V21-9846

Bulk	Length	Height	Width	Color	Screw	Insert
V21-9846WHC18D	18'	2"	1-23/64"	Frosty White	#8	S11-4650

Please refer to page REF101 for color and finish information



Call 800.226.8201 Boat Builders & Accessory Manufacturers
Call 800.653.8568 Aftermarket Distributors
TACOMarine.com

Rigid Vinyl Accepts Stainless Steel Insert

- Rigid vinyl rub rail with stainless steel insert provides the ultimate in durability and elegance • Ideal for 20' to 40' boats
- Drilled and countersunk on 8" centers

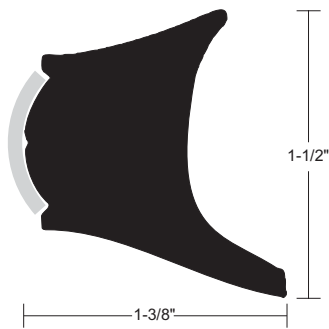

V21-1025

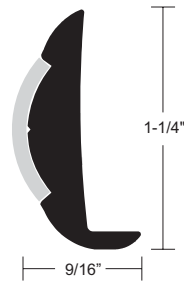

V21-9648

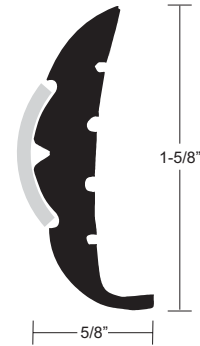

V21-9659

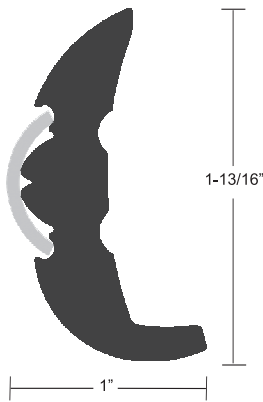

V21-9679

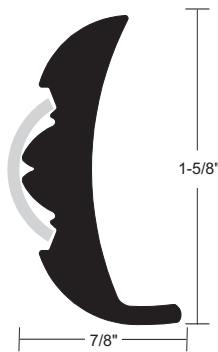

V21-9722

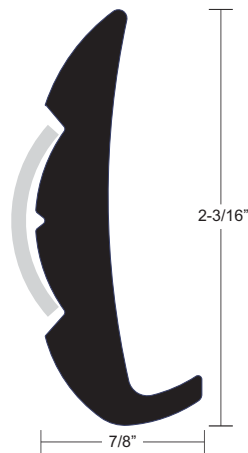

V21-9790

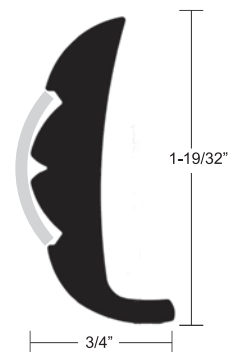

V21-9866

Bulk	Length	Height	Width	Color	Screw	Insert	End Cap
V21-1025WHC20D	20'	1-1/2"	1-3/8"	Frosty White	#10*	S11-4511	-
V21-9648WHC20D	20'	1-1/4"	9/16"	Frosty White	#8	S11-4511	-
V21-9659BKA20D	20'	1-5/8"	5/8"	Black	#8	S11-4511	F16-0039
V21-9659WHD20D	20'	1-5/8"	5/8"	Silver White	#8	S11-4511	F16-0039
V21-9679BKA20D	20'	1-13/16"	1"	Black	#8	S11-4511	F16-0037, F16-0038
V21-9679WHC20D	20'	1-13/16"	1"	Frosty White	#8	S11-4511	F16-0037, F16-0038
V21-9722BKA20D	20'	1-5/8"	7/8"	Black	#8	S11-4511	-
V21-9790BKA20D	20'	2-3/16"	7/8"	Black	#10	S11-4650	-
V21-9866WHC20D	20'	1-19/32"	3/4"	Frosty White	#8	S11-4511	F16-0039

*Drilled and countersunk on 6" centers

Please refer to page REF101 for color and finish information

Call 800.226.8201 Boat Builders & Accessory Manufacturers
Call 800.653.8568 Aftermarket Distributors
TACOMarine.com



Rigid Vinyl Accepts Stainless Steel Insert (Cont'd)

- Provides the ultimate in durability and elegance with a stainless steel insert
- Ideal for the 30' to 60' boats

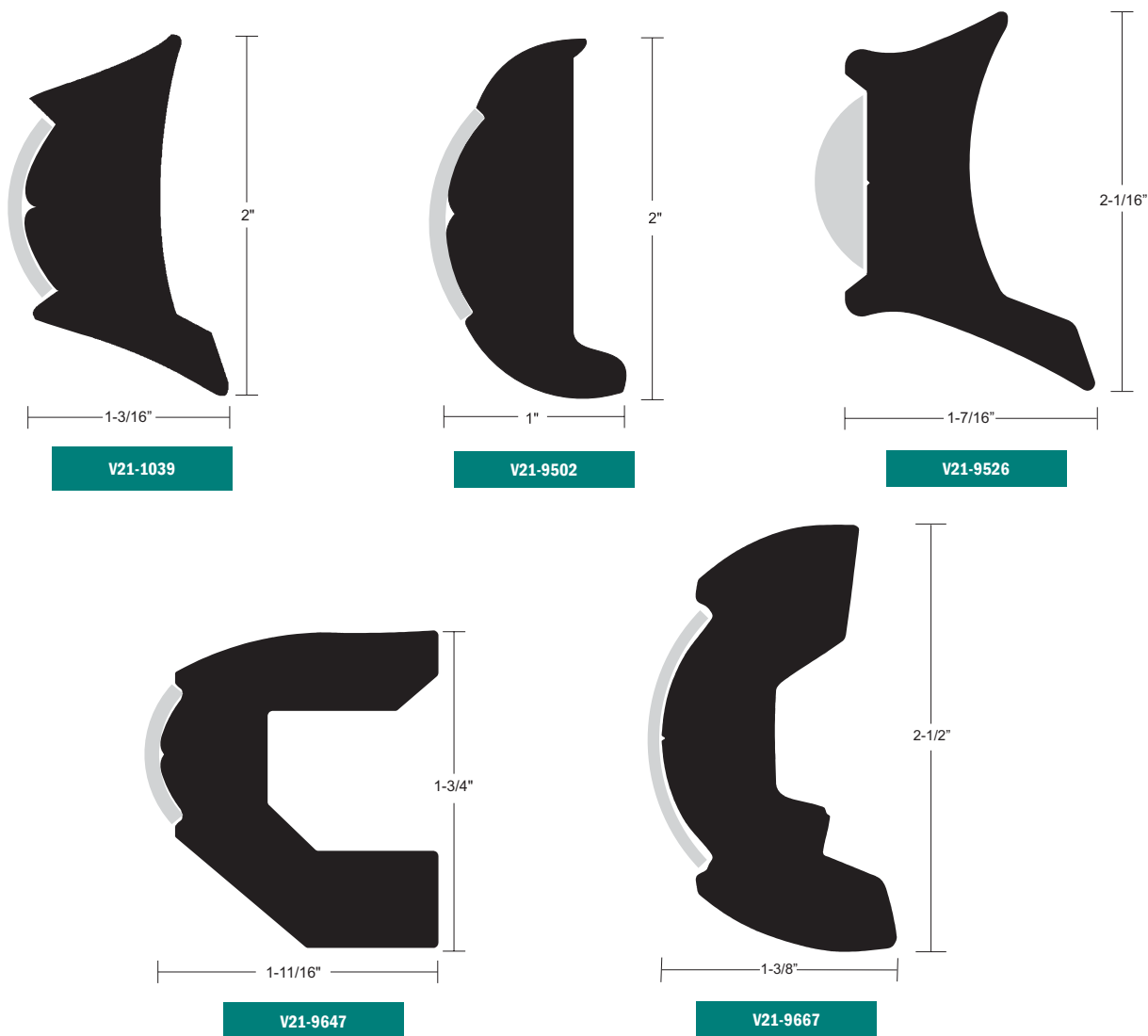

Bulk	Length	Height	Width	Color	Screw	Insert	End Cap
V21-1039BKA20D1	20'	2"	1-3/16"	Black	#8 [†]	S11-4650	F16-0039
V21-9502BKA20D	20'	2"	1"	Black	#8 [*]	S11-4650	-
V21-9502WHC20DV05	20'	2"	1"	Frosty White	#10 [*]	S11-4650	F16-0039
V21-9526WHC20D	20'	2-1/16"	1-7/16"	Frosty White	#12 [*]	S11-465S	F16-0039
V21-9647WHA20D	20'	1-3/4"	1-11/16"	Arctic White	#10 [†]	S11-4511	F16-0039
V21-9667WHC20D	20'	2-1/2"	1-3/8"	Frosty White	#10 [*]	S11-4690	-

^{*}Drilled and countersunk on 6" centers [†]Drilled and countersunk on 12" centers

Please refer to page REF101 for color and finish information



Call 800.226.8201 Boat Builders & Accessory Manufacturers
 Call 800.653.8568 Aftermarket Distributors
TACOMarine.com

Rigid Vinyl Accepts Flexible Insert

- Flexible insert covers fasteners and provides a soft, cushioning effect against normal bumps from pilings and docks
- Ideal for boats up to 30'

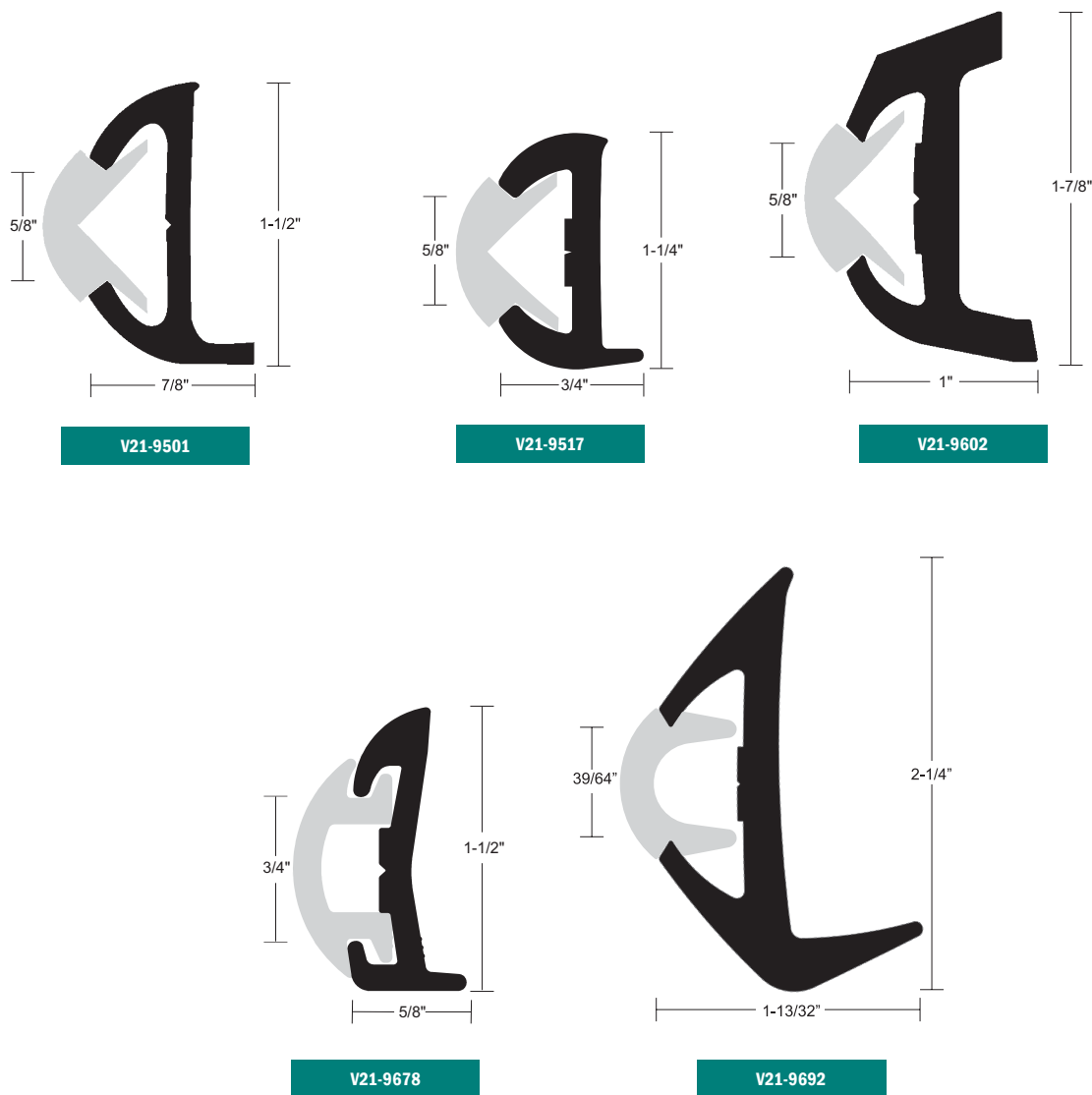

Bulk	Length	Height	Width	Color	Screw	Insert	End Cap
V21-9501WHA20D	20'	1-1/2"	7/8"	Frosty White	#10*	V12-0303	F90-0002
V21-9517BKA20D	20'	1-1/4"	3/4"	Black	#10*	V12-0303	-
V21-9602WHA20D	20'	1-7/8"	1"	Arctic White	#10*	V12-0303	-
V21-9678WHA20D	20'	1-1/2"	5/8"	Arctic White	#8*	V12-4144	-
V21-9678BKA20D	20'	1-1/2"	5/8"	Black	#8*	V12-4144	-
V21-9692WHA20D	20'	2-1/4"	1-13/32"	Cream	#10*	V12-4153	-

*Drilled and countersunk on 6" centers *Drilled and countersunk on 8" centers *Drilled only on 6" centers

Please refer to page REF101 for color and finish information

Call 800.226.8201 Boat Builders & Accessory Manufacturers
Call 800.653.8568 Aftermarket Distributors
TACOMarine.com



Rigid Vinyl

- Designed for use without an insert • Provides good basic protection • Ideal for work boats • Drilled and countersunk on 6" centers

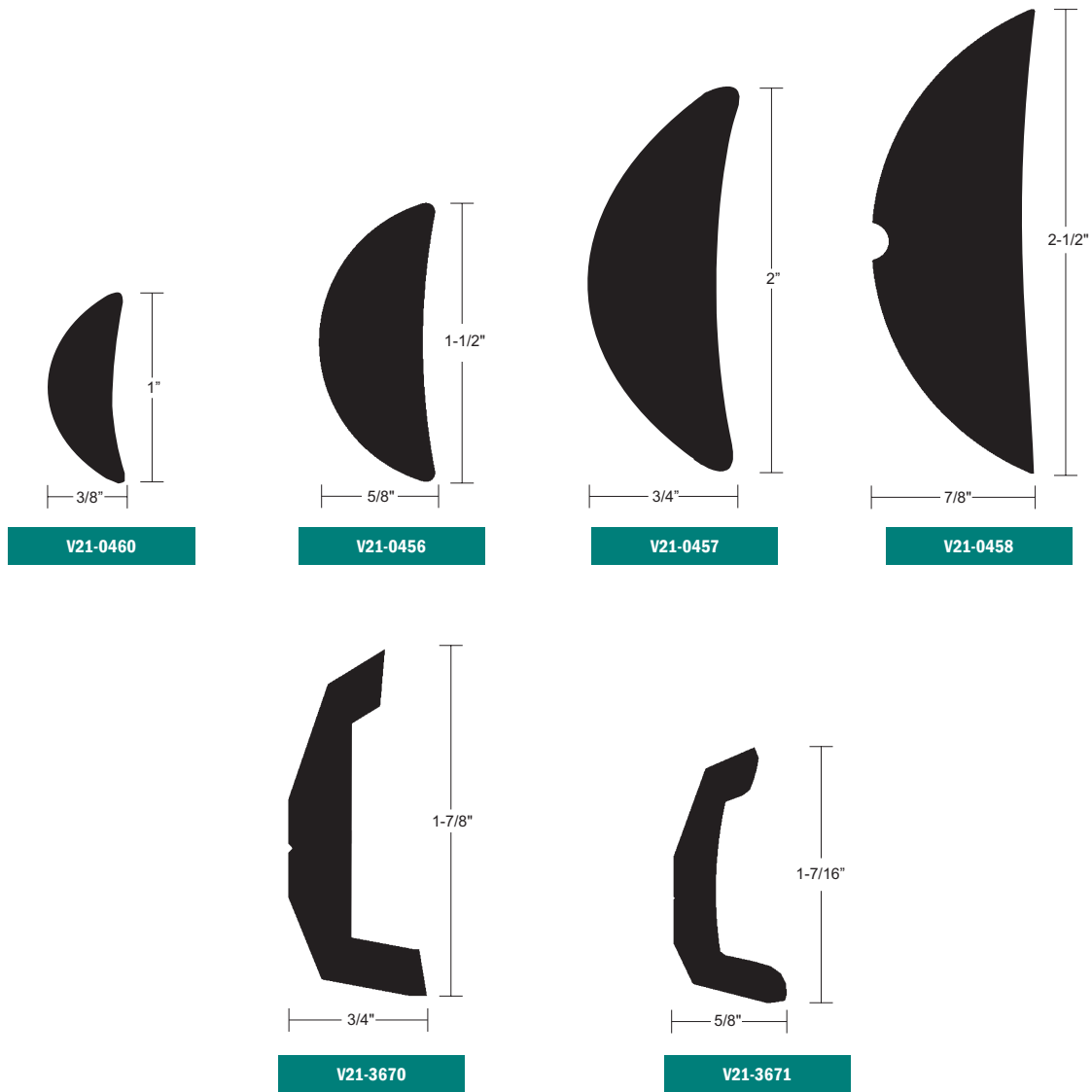

Bulk	Retail*	Length	Height	Width	Color	Screw	End Cap
V21-0460BKA12D	-	12'	1"	3/8"	Black	#6	F90-0002
V21-0456BKA12D	-	12'	1-1/2"	5/8"	Black	#8	F90-0002
V21-0457BKA20D	-	20'	2"	3/4"	Black	#8	F90-0001
V21-0458BKA20D	-	20'	2-1/2"	7/8"	Black	#10	-
V21-3670BKA20D	V21-3670BKA20D-1	20'	1-7/8"	3/4"	Black	#10 [▼]	F90-0001
V21-3670WHA20D	V21-3670WHA20D-1	20'	1-7/8"	3/4"	Arctic White	#10 [▼]	F90-0001
V21-3671BKA20D2	-	20'	1-7/16"	5/8"	Black	#10 [▼]	F90-0002
V21-3671WHA20D2	-	20'	1-7/16"	5/8"	Arctic White	#10 [▼]	F90-0002

*Drilled and countersunk on 8" centers *Boxed and coiled for UPS compliance

Please refer to page REF101 for color and finish information



Call 800.226.8201 Boat Builders & Accessory Manufacturers
 Call 800.653.8568 Aftermarket Distributors
TACOMarine.com

Rigid Vinyl (cont'd)

Bulk	Length	Height	Width	Color	Screw
V21-0188BKA20D	20'	1-9/16"	13/16"	Black	#8 *
V21-0205BKA20D	20'	2-1/4"	1-3/8"	Black	#10 †

*Drilled and countersunk on 6" centers †Drilled and countersunk on 8" centers

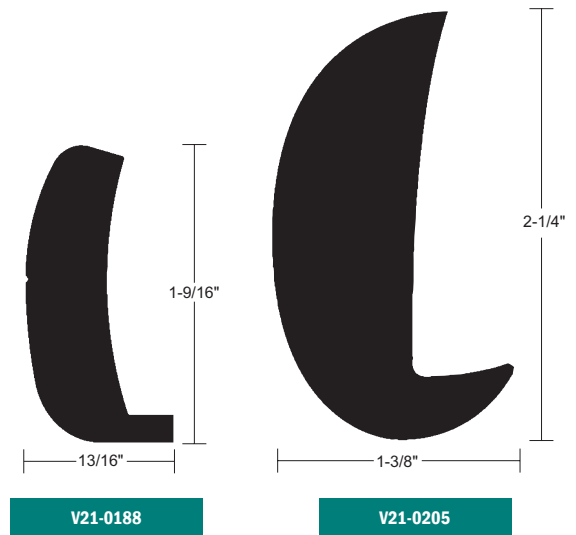

Spray Rail

- Provides protection against water spray • Keeps boat dry and improves performance through lift

Bulk	Length	Height	Width	Color
V21-0874WHA18	18'	2-1/16"	1-7/16"	Arctic White



Canoe Rail

- Rigid vinyl • Specially designed built-in hand grip • Fits a wide variety of canoes • Offers additional structural support

Bulk	Length	Height	Width	Color
V21-9140BKA166	16' 6"	1-1/4"	1-3/4"	Black

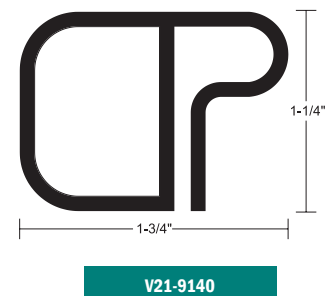

Please refer to page REF101 for color and finish information

Call 800.226.8201 Boat Builders & Accessory Manufacturers
Call 800.653.8568 Aftermarket Distributors
TACOMarine.com





Semi-Rigid Vinyl

- Offers the same appearance and performance found in rigid rub rail but with the easier formability
- Tight radius bending accomplished with minimal heating

Semi-Rigid Vinyl Accepts Insert

- Flexible and durable
- Continuous coils for one-piece installation without seams
- Offered with stainless steel and flexible inserts

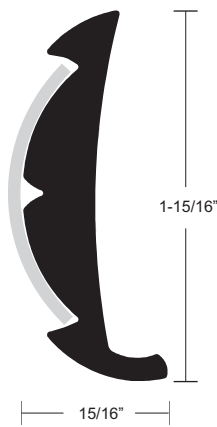

V11-9669

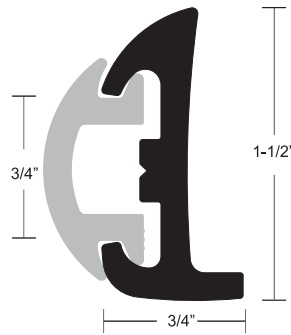

V11-9795

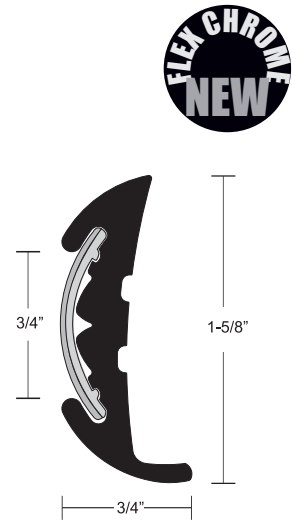

V11-9811
Flex Chrome Insert

Bulk	Length	Height	Width	Color	Insert
V11-9669WHA100	100'	1-15/16"	15/16"	Arctic White	S11-4690
V11-9795BKA50D-1	50'	1-1/2"	3/4"	Black	V12-4144
V11-9811WHC70	70'	1-5/8"	3/4"	Frosty White	V12-9809

See page RR18 for Flexible Chrome Inserts

Please refer to page REF101 for color and finish information



Call 800.226.8201 Boat Builders & Accessory Manufacturers
Call 800.653.8568 Aftermarket Distributors
TACOMarine.com



Stainless Steel

- Superior impact resistance, strength and durability
- Extra-strong marine grade stainless steel type 304 and 316 ideal for yachts
- Elegant, polished-mirror finish
- Available in solid and hollow-back varieties
- #1 choice for long-term value, corrosion-resistance and appearance

FEATURE PRODUCT

Yacht-Style Stainless Steel Rub Rail

- › Unique Euro-styling, designed for larger boats
- › Elegant, polished-mirror finish makes it ideal for yachts
- › Predominantly stainless with small, visible vinyl insert
- › Optional, rigid vinyl backing absorbs impact and prevents denting
- › Black insert accents rail, conceals fasteners for a clean look

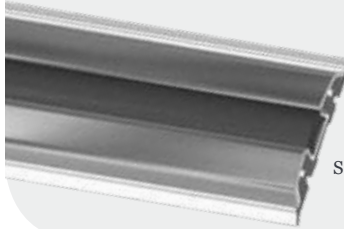

S11-1950P16B



NEW!

Three-Part Design

Stainless Steel Accepts Vinyl Insert

- Stainless steel type 316 • Flexible vinyl insert • Polished mirror finish • Stylish European design • Optional rigid vinyl track installed behind stainless rub rail, absorbs impact for added strength • Custom formed bow and stern components available upon request

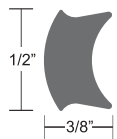

V12-9814

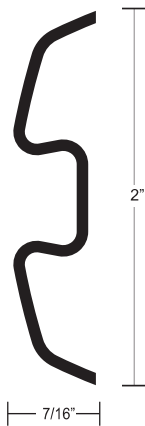

S11-1950

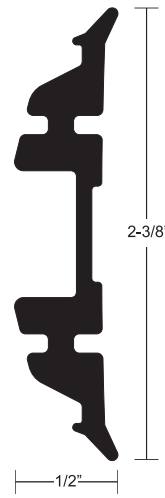

V25-9815

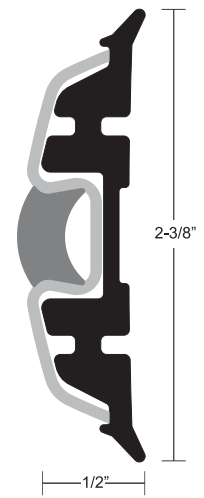

Assembled View

Bulk	Length	Height	Width	Color	Gauge	Screw
S11-1950P16B*	16'	2"	7/16"	-	.060"	#8
V12-9814BKA250	250'	1/2"	3/8"	Black	-	-
V25-9815WHA20D*	20'	2-3/8"	1/2"	Arctic White	-	#8

*Drilled and countersunk on 6" centers

Please refer to page REF101 for color and finish information

Call 800.226.8201 Boat Builders & Accessory Manufacturers
 Call 800.653.8568 Aftermarket Distributors
TACOMarine.com



Stainless Steel Hollow Back

- Superior stainless steel • Concave back design fits rigid vinyl rub rail • Polished mirror finish • Drilled and countersunk on 6" centers



Type 304

Bulk	Retail	Length	Width	Gauge	Screw	Rail End
S11-4500P12	-	12'	1/2"	.062"	#6	-
-	S11-4511P6-1	6'	3/4"	.062"	#8	S11-2000P12
S11-4511P12	-	12'	3/4"	.062"	#8	S11-2000P12
S11-4511P16	-	16'	3/4"	.062"	#8	S11-2000P12
S11-4511P20	-	20'	3/4"	.062"	#8	S11-2000P12
S11-4650P12	-	12'	1"	.077"	#10	S11-2001P12
-	S11-4650P6-1	6'	1"	.077"	#10	S11-2001P12
S11-4670P12	-	12'	1-1/4"	.077"	#10	S11-2002P12
S11-4690P12	-	12'	1-1/2"	.077"	#10	-

Type 316

Bulk	Length	Width	Gauge	Screw	Rail End
S11-4511P16B	16'	3/4"	.062"	#8	S11-2000P12
S11-4650P16B	16'	1"	.077"	#10	S11-2001P12

Stainless Steel Solid Back

Type 316

- Solid, stainless steel design • Ideal for larger, heavier boats and yachts • Drilled and countersunk on 6" centers • Offered in stainless steel type 316 and 304



Bulk	Length	Width	Thickness	Screw
S11-450SP12*	12'	1/2"	5/32"	#6
S11-451SP12B	12'	3/4"	3/16"	#10
S11-465SP20B	20'	1"	1/4"	#12
S11-467SP20B	20'	1-1/4"	1/4"	#12
S11-469SP20B	20'	1-1/2"	3/8"	#12
S11-471SP20B	20'	2"	1/2"	#14*

*Stainless steel type 304 *Drilled and countersunk on 8" centers

Please refer to page REF101 for color and finish information



Call 800.226.8201 Boat Builders & Accessory Manufacturers
Call 800.653.8568 Aftermarket Distributors
TACOMarine.com



Flexible Vinyl

- Soft durometer provides cushion to absorb impact
- Continuous coils for seamless, one-piece installation
- Tight radius bending accomplished with minimal heating

Flexible Vinyl Accepts Flexible Insert

- Easy handling making these rub rails a good choice for Do-It-Yourself boaters

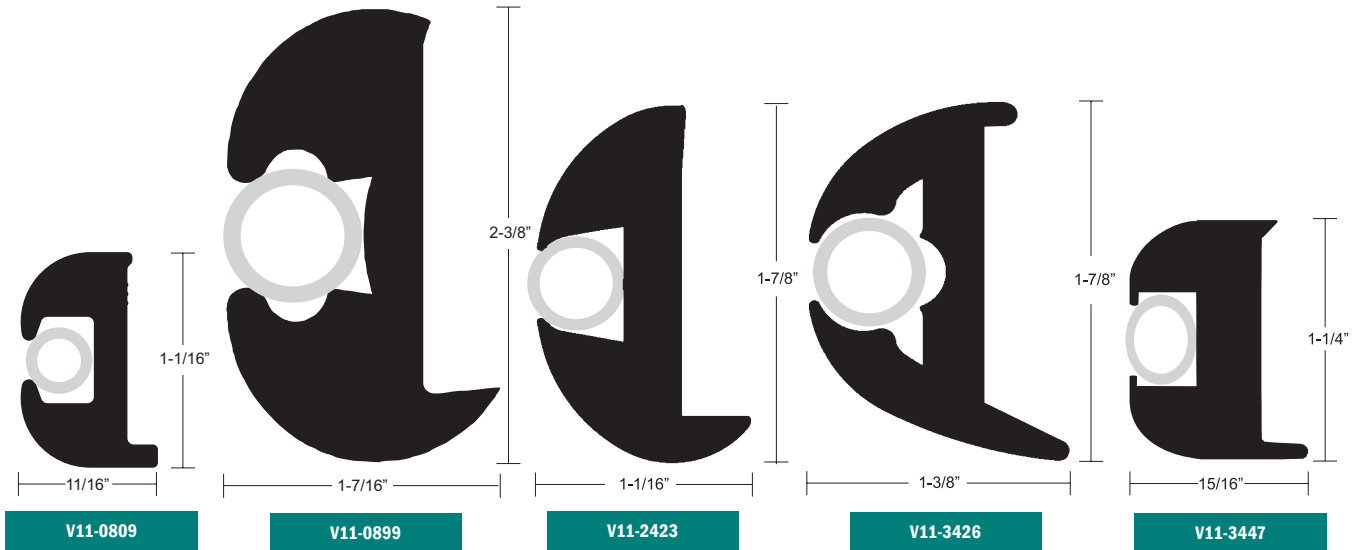

Bulk	Retail*	Length	Height	Width	Color	Insert	End Cap
-	V11-0809BKA50-1	50'	1-1/16"	11/16"	Black	V12-0810	F90-0750
V11-0899BKA100	-	100'	2-3/8"	1-7/16"	Black	V12-0005	-
V11-2423BKA50	V11-2423BKA50-1	50'	1-7/8"	1-1/16"	Black	V12-0003	F90-0001
-	V11-2423BKA70-1	70'	1-7/8"	1-1/16"	Black	V12-0003	F90-0001
V11-2423BKA100	V11-2423BKA100-1	100'	1-7/8"	1-1/16"	Black	V12-0003	F90-0001
V11-3426BKA50	V11-3426BKA50-1	50'	1-7/8"	1-3/8"	Black	V12-0005	F90-0001
-	V11-3426BKA70-1	70'	1-7/8"	1-3/8"	Black	V12-0005	F90-0001
-	V11-3447BKA50-1	50'	1-1/4"	15/16"	Black	V12-0003	F90-0002
V11-3447BKA70	-	70'	1-1/4"	15/16"	Black	V12-0003	F90-0002
V11-3447BKA100	V11-3447BKA100-1	100'	1-1/4"	15/16"	Black	V12-0003	F90-0002
V11-4014BKA70*	-	70'	1-5/8"	15/16"	Black	V12-0003	-

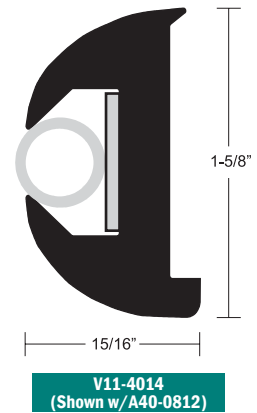

*See page RR21 for A40-0812 stiffener *Boxed and coiled for UPS compliance

Flexible Vinyl Accepts Rigid Vinyl Insert

- Flexible rub rail for a variety of inserts • "Sandwich-style" rub rail caps over deck and hull joint and typically used on sailboats

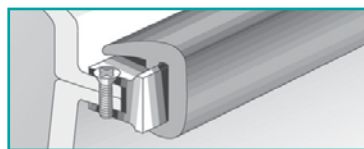

Retail	Length	Height	Width	Color	Insert	End Cap
V11-0232BKA100-1*	100'	1-3/8"	1-1/2"	Black	V22-0233	-
V11-0232WHA100-1*	100'	1-3/8"	1-1/2"	Arctic White	V22-0233	-
V11-3161BKA50-1*	50'	1-1/8"	1-1/4"	Black	V22-3162	F90-0002
V22-3162BKA12	12'	3/4"	11/16"	Black	-	-

*Boxed and coiled for UPS compliance

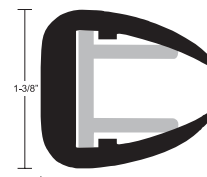

V11-0232
(shown at 60% scale)

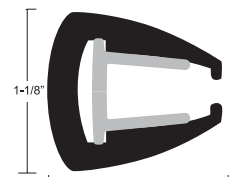

V11-3161
(shown at 75% scale)

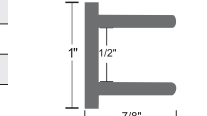

V22-0233
(shown at 55% scale)

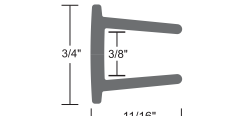

V22-3162
(shown at 70% scale)

Please refer to page REF101 for color and finish information

Call 800.226.8201 Boat Builders & Accessory Manufacturers
Call 800.653.8568 Aftermarket Distributors
TACOMarine.com





Rub Rail Kit

- Complete with rub rail, insert, end-caps screws and downloadable installation guide
- Available in a variety of lengths, widths, styles and colors
- Continuous coil for easy, one-piece, seamless installation
- Attractive retail box with cut-out for product viewing
- UPS compliant packaging

Flexible Vinyl

- Soft durometer rub rail provides cushion effect to absorb impact
- Tight radius bends require minimal heat

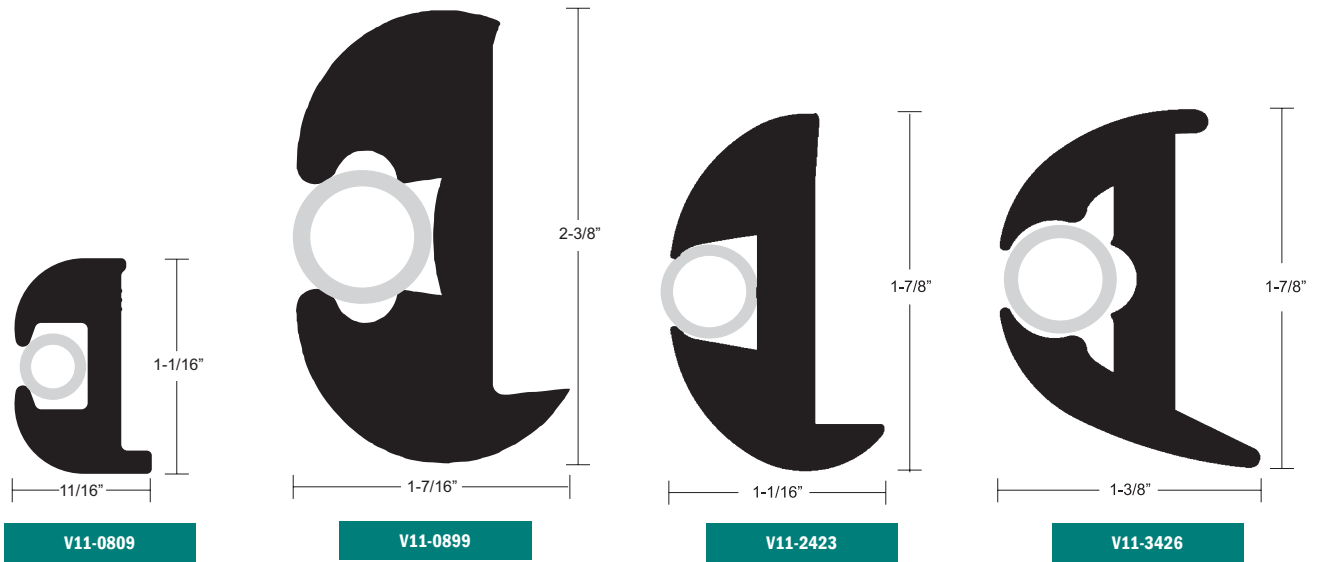

Retail	Length	Height	Width	RR Color	Insert Color
V11-0809BBK50-2	50'	1-1/16"	11/16"	Black	Black
V11-0809BBK70-2	70'	1-1/16"	11/16"	Black	Black
V11-0809BWK50-2	50'	1-1/16"	11/16"	Black	Arctic White
V11-0899BBK100-2	100'	2-3/8"	1-7/16"	Black	Black
V11-2423BBK50-2	50'	1-7/8"	1-1/16"	Black	Black
V11-2423BBK70-2	70'	1-7/8"	1-1/16"	Black	Black
V11-2423BWK50-2	50'	1-7/8"	1-1/16"	Black	Arctic White
V11-2423BWK70-2	70'	1-7/8"	1-1/16"	Black	Arctic White
V11-3426BBK50-2	50'	1-7/8"	1-3/8"	Black	Black
V11-3426BBK70-2	70'	1-7/8"	1-3/8"	Black	Black
V11-3426BWK50-2	50'	1-7/8"	1-3/8"	Black	Arctic White
V11-3426BWK70-2	70'	1-7/8"	1-3/8"	Black	Arctic White
V11-3447BBK50-2 *	50'	1-1/4"	15/16"	Black	Black
V11-3447BBK70-2 *	70'	1-1/4"	15/16"	Black	Black
V11-3447BWK50-2 *	50'	1-1/4"	15/16"	Black	Arctic White
V11-3447WVK50-2 *	50'	1-1/4"	15/16"	Arctic White	Arctic White

*Optional in-line end cap F90-1870

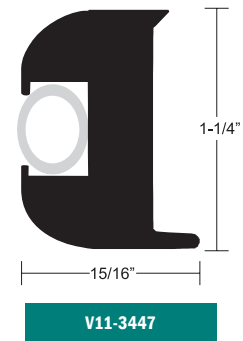

Please refer to page REF101 for color and finish information



Call 800.226.8201 Boat Builders & Accessory Manufacturers
 Call 800.653.8568 Aftermarket Distributors
TACOMarine.com

Semi-Rigid Vinyl

- Semi-Rigid rub rail is flexible and durable
- Continuous coils

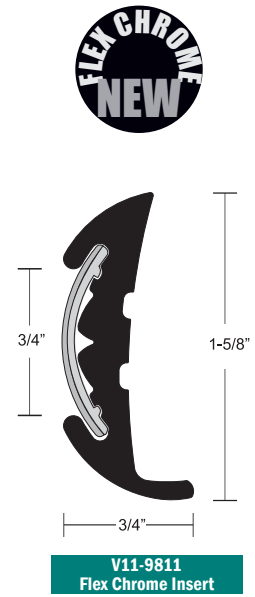
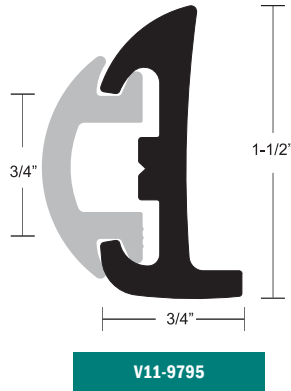
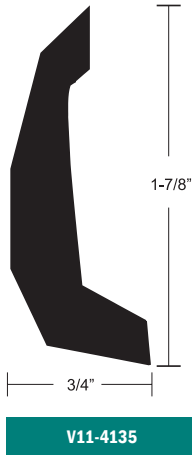

Retail	Length	Height	Width	RR Color	Insert Color
V11-4135BKA30-3	30'	1-7/8"	3/4"	Black	-
V11-9795BBK50D-2	50'	1-1/2"	3/4"	Black	Black
V11-9811WCM70-2	70'	1-5/8"	3/4"	Frosty White	Chrome

Please refer to page REF101 for color and finish information

Call 800.226.8201 Boat Builders & Accessory Manufacturers
Call 800.653.8568 Aftermarket Distributors
TACOMarine.com





Aluminum

- Classic look
- High-grade 6063 aluminum alloy and temper for easy tight radius bending
- Provides added strength and protection
- Anodized finish stands up to the harsh marine environment

Aluminum

- Designed for use without an insert
- Polished clear anodized finish
- Drilled and countersunk on 6" centers



A50-0195



A50-0197



A50-0199

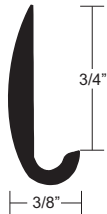

A11-0151



A11-0152

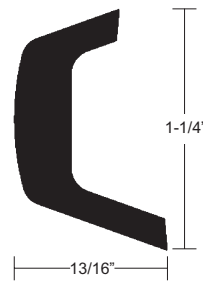

A11-0511

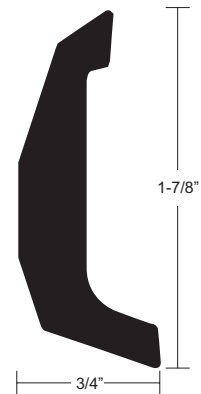

A11-0514

Bulk	Length	Height	Width	Screw
A11-0151TAL12D	12'	3/4"	3/8"	#8
A11-0152TAL12D-A	12'	1"	7/16"	#8
A11-0511TAL20D	20'	1-1/4"	13/16"	#10
A11-0514TAL20D	20'	1-7/8"	3/4"	#10
A50-0195TAL12D	12'	3/4"	3/16"	#5
A50-0197TAL12D	12'	1"	3/16"	#6
A50-0199TAL12D1	12'	1-1/4"	1/4"	#6

Please refer to page REF101 for color and finish information



Call 800.226.8201 Boat Builders & Accessory Manufacturers
 Call 800.653.8568 Aftermarket Distributors
TACOMarine.com

Aluminum Accepts Flexible Insert

- Drilled and countersunk on 6" centers

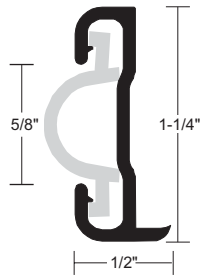

A11-0317

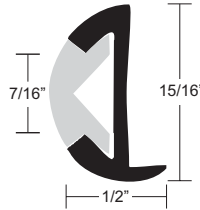

A11-0342

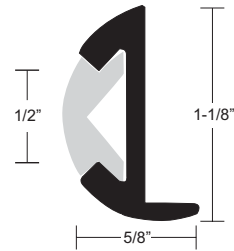

A11-0347

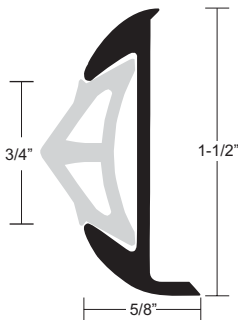

A11-0638

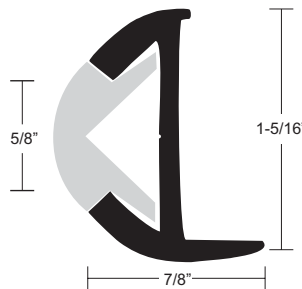

A12-0303

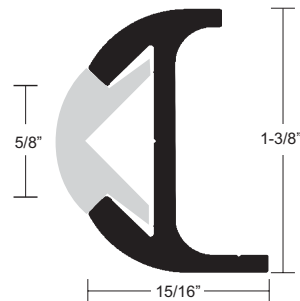

A12-0305

Bulk	Length	Height	Width	Screw	Finish	Insert	End Cap
A11-0317TAL12D	12'	1-1/4"	1/2"	#8	Polished Clear Anodized	V12-0317	-
A11-0342BLY12D	12'	15/16"	1/2"	#8	Brite Anodized	V12-0342	F90-0750BN
A11-0347BLY12D	12'	1-1/8"	5/8"	#8	Brite Anodized	V12-4155	F90-0100CAY
A11-0638TAL12D	12'	1-1/2"	5/8"	#8	Polished Clear Anodized	V12-0338	-
A12-0303BLY12D	12'	1-5/16"	7/8"	#10	Brite Anodized	V12-0303	F90-1870BKA
A12-0305BLY12D	12'	1-3/8"	15/16"	#10	Brite Anodized	V12-0303	F90-1870BKA

Sailboat Toe Rail

- Mounts along the edge of deck to attach lines and hardware • 1-1/4" x 5/8" slots for attachments • Slot spacing on 10" centers
- Drilled and countersunk on 4" centers

Bulk	Length	Height	Width	Screw	Finish
A62-0009VEL34D	34'	1-9/16"	1-1/2"	1/4"	Satin Anodized

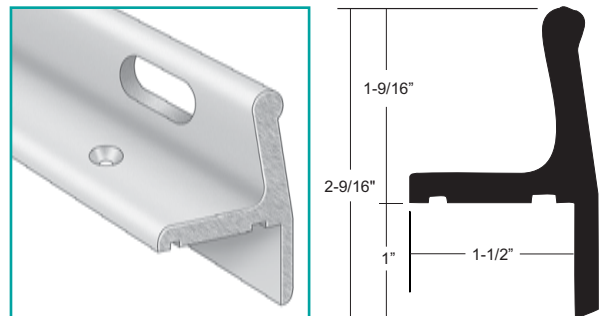

A62-0009

Please refer to page REF101 for color and finish information

Call 800.226.8201 Boat Builders & Accessory Manufacturers
Call 800.653.8568 Aftermarket Distributors
TACOMarine.com





Inserts

- Continuous coils provide seamless, one-piece installation
- Provides added protection
- Hides fasteners for clean, smooth look

FEATURE PRODUCT

Flexible Vinyl Chrome Insert



- › Co-extruded specially-formulated chrome mylar is applied and laminated in-line to the surface of the extruded flexible vinyl insert
- › Offers elegant stainless steel look at much lower cost
- › Won't rust or corrode
- › Installs without screws, reducing installation costs while offering a sleek look



V12-9809

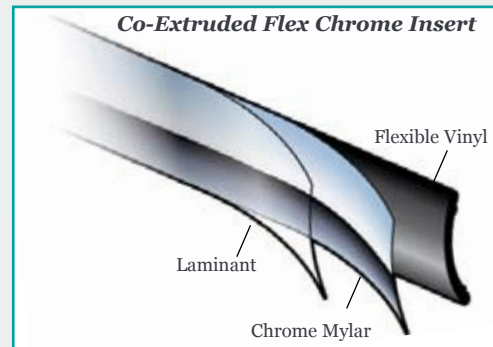

Flexible Vinyl Chrome Insert

- Soft durometer provides cushion effect to absorb impact
- Variety of colors available
- Continuous coils for one piece installation without seams

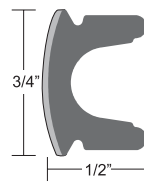

V12-0307

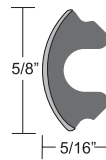

V12-1069
Fits V21-9811

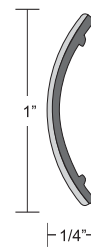

V12-9809
Fits V21-9662



Bulk	Retail	Length	Height	Width	Color
V12-0307CP165	-	165'	3/4"	1/2"	Chrome
V12-1069CP165	-	165'	5/8"	5/16"	Chrome
-	V12-1069CP70-1	70'	5/8"	5/16"	Chrome
V12-9809CP210	-	210'	1"	1/4"	Chrome

Please refer to page REF101 for color and finish information



Call 800.226.8201 Boat Builders & Accessory Manufacturers
Call 800.653.8568 Aftermarket Distributors
TACOMarine.com

Flexible Vinyl

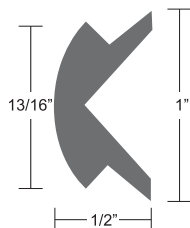

V12-0303

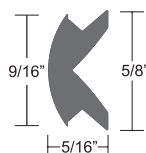

V12-0342

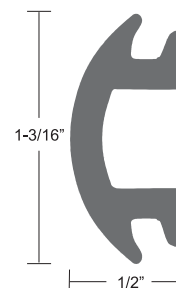

V12-4144

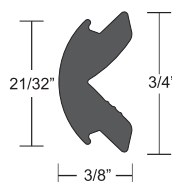

V12-4155

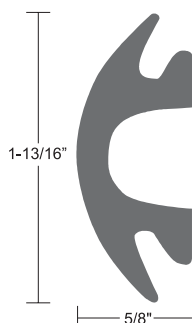

V12-5818



V12-9814

Bulk	Retail	Length	Height	Width	Color
V12-0303BKA200	-	200'	1"	1/2"	Black
-	V12-0303BKA50-1	50'	1"	1/2"	Black
-	V12-0303BKA70-1	70'	1"	1/2"	Black
V12-0303WHA300	-	300'	1"	1/2"	Arctic White
-	V12-0303WHA50-1	50'	1"	1/2"	Arctic White
-	V12-0303WHA70-1	70'	1"	1/2"	Arctic White
V12-0303WHC200	-	200'	1"	1/2"	Frosty White
-	V12-0303WHC50-1	50'	1"	1/2"	Frosty White
-	V12-0303WHC70-1	70'	1"	1/2"	Frosty White
V12-0342BKA250	-	250'	5/8"	5/16"	Black
-	V12-0342BKA50-1	50'	5/8"	5/16"	Black
V12-4144BKA250	-	250'	1-3/16"	1/2"	Black
-	V12-4144BKA50-1	50'	1-3/16"	1/2"	Black
-	V12-4144BKA70-1	70'	1-3/16"	1/2"	Black
-	V12-4155BKA50-1	50'	3/4"	3/8"	Black
V12-5818BKA250	-	250'	1-13/16"	5/8"	Black
V12-9814BKA250	-	250'	1/2"	3/8"	Black

Please refer to page REF101 for color and finish information

Call 800.226.8201 Boat Builders & Accessory Manufacturers
 Call 800.653.8568 Aftermarket Distributors
TACOMarine.com



Flexible Vinyl (cont'd)

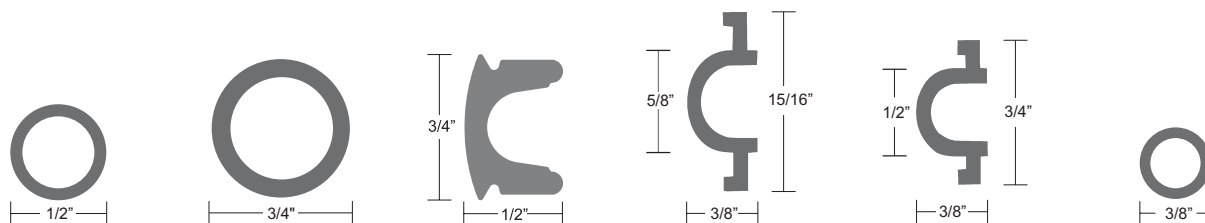

V12-0003	V12-0005	V12-0307	V12-0317	V12-0334	V12-0810
----------	----------	----------	----------	----------	----------

Bulk	Retail	Length	Height	Width	Diameter	Color
V12-0003BKA250	-	250'	-	-	1/2"	Black
-	V12-0003BKA50-1	50'	-	-	1/2"	Black
-	V12-0003BKA70-1	70'	-	-	1/2"	Black
-	V12-0003BKA100-1	100'	-	-	1/2"	Black
-	V12-0003WHA50-1	50'	-	-	1/2"	Arctic White
-	V12-0003WHA70-1	70'	-	-	1/2"	Arctic White
-	V12-0005BKA50-1	50'	-	-	3/4"	Black
-	V12-0005BKA70-1	70'	-	-	3/4"	Black
V12-0307BKA250	-	250'	3/4"	1/2"	-	Black
-	V12-0317BKA50-1	50'	15/16"	3/8"	-	Black
-	V12-0317WHA50-1	50'	15/16"	3/8"	-	Arctic White
-	V12-0334BKA50-1	50'	3/4"	3/8"	-	Black
V12-0338BKA200	-	200'	1"	1/2"	-	Black
-	V12-0338BKA50-1	50'	1"	1/2"	-	Black
-	V12-0338BKA70-1	70'	1"	1/2"	-	Black
-	V12-0338BKA100-1	100'	1"	1/2"	-	Black
-	V12-0810BKA50-1	50'	-	-	3/8"	Black
-	V12-0810WHA100-1	50'	-	-	3/8"	Arctic White
V12-4153GRS250	-	250'	51/64"	5/8"	-	Gray

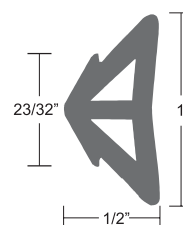

V12-0338

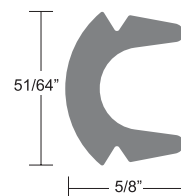

V12-4153

Rub Rail End Caps

- Caps rub rail to finish end of rail and ensure inserts stay intact

Stainless Steel Type 316

- Elegant and durable • Polished finish



F16-0039

Bulk	Width	Screw	Fits
F16-0039	1-5/8"	#8	V21-9613, V21-9659

Nylon



F90-0001



F90-0002



F90-1870

Bulk	Retail*	Width	Screw	Color	Fits
F90-0001BKN	F90-0001BKN-1	2"	#8	Black	V11-2423, V11-3426
F90-0001WVN	-	2"	#8	White	V11-2423, V11-3426
F90-0002BKN	F90-0002BKN-1	1-9/16"	#8	Black	V11-3447, V21-9659, V21-9722
F90-1870BKA	-	1-3/8"	#8	Black	A12-0303, A12-0305, V11-3447

*Retail blister packaging (pair)

Please refer to page REF101 for color and finish information



Call 800.226.8201 Boat Builders & Accessory Manufacturers
 Call 800.653.8568 Aftermarket Distributors
TACOMarine.com



Accessories

- TACO offers a complete line of rub rail accessories in a variety of styles, sizes and colors for any rub rail application

Rub Rail Stiffener

Aluminum

- Stiffener for V11-4014 with V12-0003 Insert • Inserts into flexible vinyl rub rail • Supports fasteners for smooth installation
- Drilled and countersunk on 6" centers

Bulk	Length	Height	Width	Screw	Finish
A40-0812AEY10D2	10'	1/8"	3/4"	#10	Mill

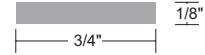

A40-0812

Splice Cap

- Caps aluminum rub rail and insert to conceal splices • Prevents insert from sliding

Retail*	Length	Width	Screw	Finish	Fits
F90-0126TAL-1	2-7/16"	1-5/8"	#6	Polished Clear Anodized	A11-0638

*Retail blister packaging (pair)



F90-0126

Rub Strakes

Stainless Steel Type 304

- Designed to prevent chafing of dock, fender and anchor lines • Ideal for yachts and larger boats with heavy lines

Bulk	Length	Width	Screw
S11-1700P8	8"	3/4"	#8
S11-1700P12	12"	3/4"	#8
S11-1700P18	18"	3/4"	#8
S11-1700P24	24"	3/4"	#8
S11-1800P12	12"	1"	#10
S11-1800P18	18"	1"	#10
S11-1800P24	24"	1"	#10



Rub Strake

Rail Ends

Stainless Steel Type 304

- Creates a finished appearance to stainless steel rub rail

Bulk	Length	Width	Screw
S11-2000P12	12"	3/4"	#8
S11-2001P12	12"	1"	#10



Rail End

Please refer to page REF101 for color and finish information

Call 800.226.8201 Boat Builders & Accessory Manufacturers
Call 800.653.8568 Aftermarket Distributors
TACOMarine.com



Moulding

TACO Metals supplies quality trim, weather seal and hatch tape that is designed to protect boat interiors and exteriors from the harsh marine environment.

TRIM & MOULDING

Trim and moulding products provide finish, protection and structural integrity. TACO trim and moulding products are the best in the industry and are used extensively throughout boat interiors and exteriors.

TACO offers an assortment of trim and moulding products; each ideally suited for a wide range of applications - from aluminum door frames and transom trim to vinyl channels, corners and edge moulding for cabinets. TACO hatch tapes and weather seals are well suited for use in live wells, hatches and other enclosures.

MATERIALS

Depending on the product line, TACO's trim and moulding products are offered in aluminum, vinyl and specially formulated rubber compounds. TACO insists on using prime billet 6000 series aluminum alloys to ensure superior structural strength, precise bending and long-lasting performance. Vinyl and plastic products are made from prime resin and warranted for 5 years. TACO weather seal and hatch tape products are made of specially formulated rubber compounds, designed and engineered to provide maximum sealing capacity and protect against weathering and vibration.

TACO STOCKING INVENTORY PROGRAM

All TACO trim and moulding products featured in this catalog are part of TACO's industry leading stocking program, which offers competitive pricing, a wide assortment of product and stocked inventory to ensure ready availability.

Trim &



23

Vinyl

24

Aluminum

26

Frames

27

Track Hardware

29

Seals



Vinyl

- Finishes and protects edges
- Perfect for interiors and exteriors

Rigid

Angle Moulding

- Tough, durable and long-lasting • Increase structural integrity • UV-resistant PVC compound
- Ideal for cabin doors and inside deck combing • Cuts and drills like wood

Bulk	Length	Height	Width	Color
V25-9124BKA14D*	14'	9/16"	1/4"	Black
V25-0240BKA12	12'	7/8"	7/8"	Black
V25-0240WHA12	12'	7/8"	7/8"	Arctic White
V25-9519WHA10	10'	1-1/4"	3/4"	Arctic White

*Drilled on 6" centers

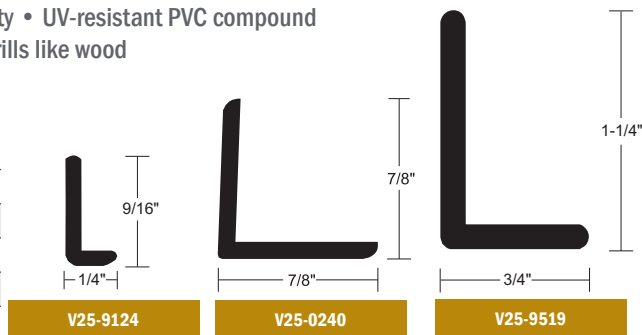

Edge Moulding

- UV-resistant, superb weather-ability, great for exposed areas

Bulk	Length	Height	Width	Color
V25-0786BKA12	12'	13/16"	5/16"	Black
V25-0474BKA20	20'	1-1/8"	3/8"	Black
V25-0474WHA20	20'	1-1/8"	3/8"	Arctic White

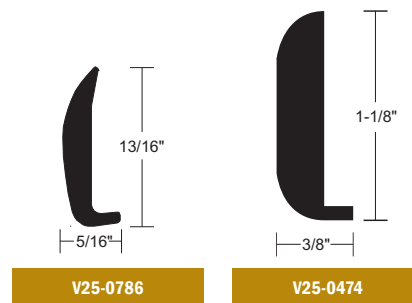

Flexible

U-Channel Insert

- Soft durometer for cushion to absorb impact • Continuous coil for one piece installation
- Tight radius bending without heating

Bulk	Length	Height	Width	Color
V15-5585WHC200	200'	11/16"	7/8"	Frosty White



Flex Trim

- Covers unfinished edges and follows almost any contour or radius
- Made of flexible PVC
- Integrated interior aluminum clip and gripping tongue ensures a better fit



Flex Trim Cross Section



Flex Trim

Bulk	Retail	Length	"A"	"B"	Color
V30-1005B250	-	250'	5/32"	9/16"	Black
-	V30-1005B25-1	25'	5/32"	9/16"	Black
V30-1005W250	-	250'	5/32"	9/16"	White
-	V30-1005W25-1	25'	5/32"	9/16"	White
V30-1008B250	-	250'	1/4"	1/2"	Black
-	V30-1008B25-1	25'	1/4"	1/2"	Black
V30-1008W250	-	250'	1/4"	1/2"	White
-	V30-1008W25-1	25'	1/4"	1/2"	White
-	V30-1312B25-1	25'	3/8"	5/8"	Black
V30-1312W250	-	250'	3/8"	5/8"	White
-	V30-1312W25-1	25'	3/8"	5/8"	White
-	V30-1316B25-1	25'	1/2"	19/32"	Black
-	V30-1316W25-1	25'	1/2"	19/32"	White
V30-1350B250	-	250'	5/16"	21/32"	Black
V30-1375B250	-	250'	3/16"	23/32"	Black

*Please make selection according to column A (edge thickness)

Please refer to page REF101 for color and finish information

Call 800.226.8201 Boat Builders & Accessory Manufacturers
 Call 800.653.8568 Aftermarket Distributors
 TACOMarine.com





Aluminum

- Made of prime grade 6000 series aluminum alloy
- Anodized and offered in a variety of finishes
- Provides excellent finish, corrosion resistance and structural integrity

T-Hatch Trim

- Ideal for hatches

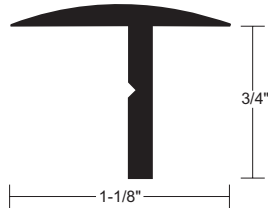

A50-0304

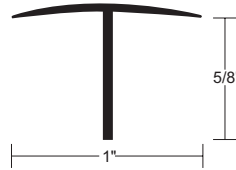

A50-0305

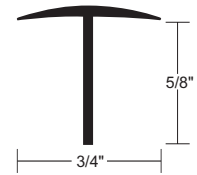

A50-0375

Bulk	Length	Height	Width	Finish
A50-0304TAL12	12'	3/4"	1-1/8"	Polished Clear Anodized
A50-0305TAL12	12'	5/8"	1"	Polished Clear Anodized
A50-0375VEL12	12'	5/8"	3/4"	Satin Anodized

Transom Trim

- Ideal for transoms • Drilled and countersunk on 6" centers

Bulk	Length	Height	Width	Thickness	Screw	Finish
A50-0326TAL12D	12'	13/16"	9/16"	1/16"	#5	Polished Clear Anodized

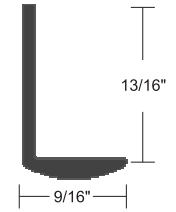

A50-0326

Edge Moulding

- Lightweight for tight radius bending • Drilled and countersunk on 6" centers

Bulk	Length	Height	Width	Thickness	Screw	Finish
A50-0272TAL12D	12'	9/16"	1/4"	1/16"	#6	Polished Clear Anodized
A50-0275TAL12D	12'	13/16"	1/4"	1/16"	#5	Polished Clear Anodized

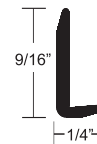

A50-0272

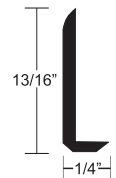

A50-0275

Channels

- Decorative channels for mounting fixed panels or partition applications

Bulk	Length	"A"	"B"	"C"	Finish
A50-0235TAL12	12'	3/8"	3/8"	.063"	Polished Clear Anodized
A52-0221BXY12	12'	3/4"	9/16"	.080"	Polished Brite Anodized
A52-0222BXY12	12'	3/4"	11/16"	.080"	Polished Brite Anodized

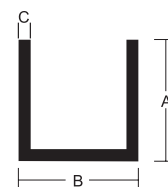

A50-0235

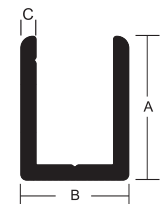

A52-0221 • A52-0222

Please refer to page REF101 for color and finish information



Call 800.226.8201 Boat Builders & Accessory Manufacturers
Call 800.653.8568 Aftermarket Distributors
TACOMarine.com

Half Ovals

- Traditional anodized aluminum edge molding and seam binders
- Available in a variety of sizes and styles
- Drilled and countersunk on 6" centers

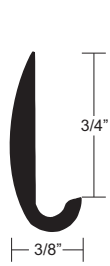

A11-0151



A11-0152



A50-0195



A50-0197



A50-0199



A51-0102

Bulk	Length	Height	Width	Screw	Finish
A11-0151TAL12D	12'	3/4"	3/8"	#8	Polished Clear Anodized
A11-0152TAL12D-A	12'	1"	7/16"	#8	Polished Clear Anodized
A50-0195TAL12D	12'	3/4"	3/16"	#5	Polished Clear Anodized
A50-0197TAL12D	12'	1"	3/16"	#6	Polished Clear Anodized
A50-0199TAL12D1	12'	1-1/4"	1/4"	#6	Polished Clear Anodized
A51-0102TAL12D	12'	1/2"	3/16"	#6	Polished Clear Anodized
A51-0102TAL12D-1*	12'	1/2"	3/16"	#6	Polished Clear Anodized
A51-0104TAL12D-A	12'	3/4"	11/64"	#6	Polished Clear Anodized
A51-0106TAL12D	12'	1"	3/16"	#6	Polished Clear Anodized

*Drilled and countersunk on 3" centers



A51-0104



A51-0106

Drip Moulding

- 6000 series prime grade aluminum alloy
- Drilled and countersunk on 6" centers

Bulk	Length	Height	Width	Screw	Finish
A51-0149TAL12D	12'	3/4"	9/16"	#6	Polished Clear Anodized

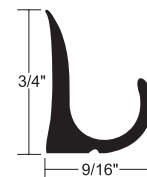

A51-0149

Hatch Trim

Stainless Steel

- Provides a finished look to hatches and doors
- Durable stainless steel type 304
- Mirror finish gives hatches and doors an elegant look

Retail	Length	Width	Gauge	Screw	Finish
S11-4660P6-1	6'	1-1/4"	.062"	#6FH	Polished
S11-4680P6-1	6'	1-1/2"	.062"	#6FH	Polished



Hatch Trim

Please refer to page REF101 for color and finish information

Call 800.226.8201 Boat Builders & Accessory Manufacturers
Call 800.653.8568 Aftermarket Distributors
TACOMarine.com





Frames

- Standard tooling for 3.5" radius door jams (4" radius cutout)
- Full radius top, custom bending and custom color matches
- Custom fabricated frames also available and produced to your specs
- Custom frames available anodized or standard powder-coated finishes
- Available with or without hardware

Door

- Aluminum extrusions • Offered in standard radius or custom

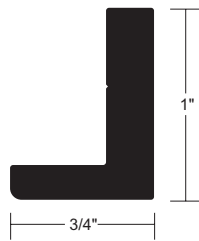

A61-0188

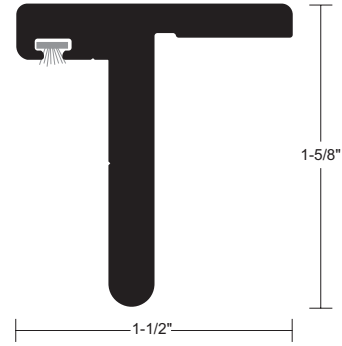

A61-0189

Bulk	Length	Height	Width	Finish
A61-0188AEY15	15'	1"	3/4"	Mill
A61-0189AEY15	15'	1-5/8"	1-1/2"	Mill

Polypile Insert

- Doorframe insert • For use with A61-0189

Bulk	Length	Height	Overall Width	Backing Width	Color
F91-0084PLP500	500'	3/16"	3/16"	1/32"	Gray

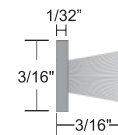

F91-0084
(shown at 120% scale)

Please refer to page REF101 for color and finish information



Call 800.226.8201 Boat Builders & Accessory Manufacturers
Call 800.653.8568 Aftermarket Distributors
TACOMarine.com



Track Hardware

- Rigid vinyl and aluminum extrusions
- For doors, isinglass and other enclosures

Canvas & Upholstery

- Track and welting • Rigid vinyl and aluminum • For canvas tops, bolsters and other enclosures

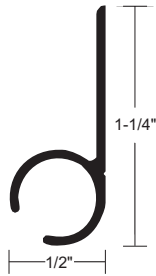

A52-0034 (Aluminum)

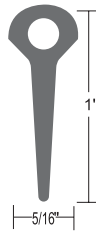

V15-0034 (Flexible)



V15-6008



V25-9207

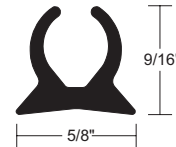

V25-9720

Bulk	Length	Height	Width	Fits	Color	Finish
A52-0034BLY16	16'	1-1/4"	1/2"	V15-0034	-	Brite Anodized
V15-0034WHA250A	250'	1"	5/16"	-	Arctic White	-
V15-6008GRA500	500'	1"	1/4"	-	Medium Gray	-
V25-9207WHA20	20'	1-3/8"	11/16"	V15-6008	Arctic White	-
V25-9720WHC20	20'	9/16"	5/8"	V15-6008	Frosty White	-
V25-9720WHC7.5	7'6"	9/16"	5/8"	V15-6008	Frosty White	-

Please refer to page REF101 for color and finish information

Call 800.226.8201 Boat Builders & Accessory Manufacturers
Call 800.653.8568 Aftermarket Distributors
TACOMarine.com



Slide Track

- Anodized aluminum • For use on Bimini canvas tops

Bulk	Length	Height	Width	Finish
A52-0037BLY14	14'	7/16"	13/16"	Brite Anodized

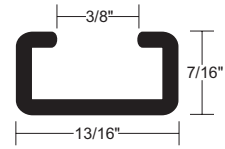

A52-0037

Sliding Door Track

- Anodized aluminum • Upper and lower track for doors up to 1/4"

Bulk	Length	Height	Width	Finish
A52-0084VEL12	12'	15/16"	3/4"	Satin Anodized
A52-0159VEL12	12'	1-1/4"	3/4"	Satin Anodized
A52-0309BLY12	12'	9/16"	1-1/16"	Brite Anodized

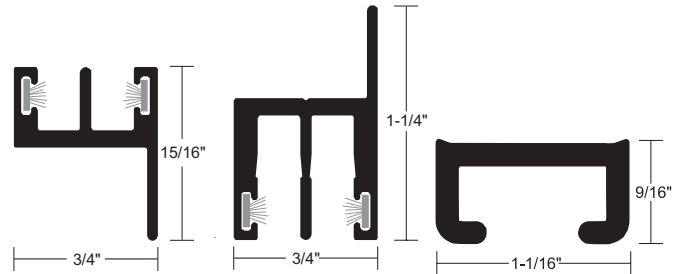

A52-0084

A52-0159

A52-0309

Polypile Insert

- Insert for sliding door track A52-0084/A52-0159

Bulk	Length	Height	Overall Width	Backing Width	Color
F91-0084PLP500	500'	3/16"	3/16"	1/32"	Gray

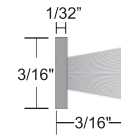
F91-0084
(shown at 120% scale)

Curtain Track & Components

- Complete anodized aluminum curtain track and nylon component system



A52-0051 track

F40-0112
Sew-On CarrierF40-0119
End Cap

Bulk	Height	Width	Length	Style	Color	Finish
A52-0051VEL12	5/16"	11/16"	12'	Track	-	Satin Anodized
F40-0112	-	-	-	Sew-On Carrier	White	-
F40-0119	-	-	-	End Cap	White	-

Please refer to page REF101 for color and finish information



Call 800.226.8201 Boat Builders & Accessory Manufacturers
Call 800.653.8568 Aftermarket Distributors
TACOMarine.com



Seals

- Seals leaks and prevents rattle
- Flexible and durable
- Specially formulated rubber materials

Hatch Tape

- Creates a tight, rattle-free seal
- Adhesive backing for convenient installation
- Durable, flexible sponge rubber compound

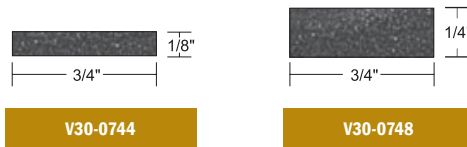

Retail	Length	Height	Width	Color
V30-0744B8-2	8'	1/8"	3/4"	Black
V30-0748B8-2	8'	1/4"	3/4"	Black

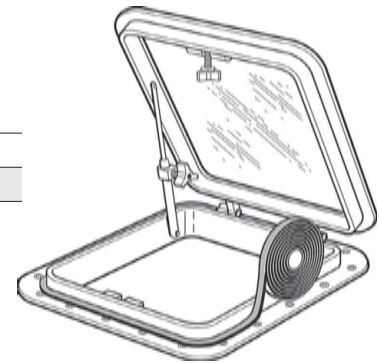

Weather Seal

- Absorbs shock and reduces vibration
- Offers superior resistance to water absorption, sunlight and extreme temperatures
- Durable EDPM synthetic rubber compound
- Ideal for live-wells, exterior doors, instrument covers and electronic boxes
- Adhesive backing for convenient installation

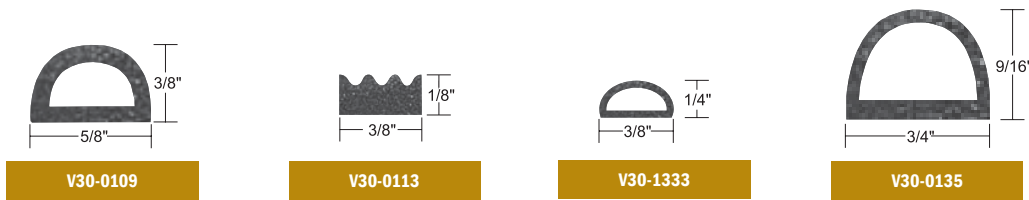

Bulk	Retail	Length	Height	Width	Color
V30-0109B500	-	500'	3/8"	5/8"	Black
-	V30-0109B10-1	10'	3/8"	5/8"	Black
V30-0113B500	-	500'	1/8"	3/8"	Black
-	V30-0113B10-1	10'	1/8"	3/8"	Black
V30-0135T250	-	250'	9/16"	3/4"	Black
-	V30-1333B10-1	10'	1/4"	3/8"	Black

Please refer to page REF101 for color and finish information

Call 800.226.8201 Boat Builders & Accessory Manufacturers
 Call 800.653.8568 Aftermarket Distributors
TACOMarine.com



Hinges & Latches

TACO Metals offers and inventories a wide array of hinges and latches for use in a variety of applications. Product offerings include:

- » Continuous or piano hinges
- » Cast hinges
- » Stamped hinges
- » Latches
- » Specialty hardware

CUSTOMIZED CONTINUOUS HINGES

TACO offers a variety of custom fabrications available to provide design flexibility and meet custom specifications. Custom fabrications include: Custom cut lengths; custom hole diameters, centers and locations; swaging to form hinge leaves for a variety of configurations. A variety of custom finishes are available as well, including painting, aluminum anodizing, stainless steel polishing and sanding. Contact your TACO representative for information.

INNOVATIVE DESIGNS

TACO's design and engineering team strive to develop innovative new products that will help to make our customers' jobs easier. Whether it is designing, building or selling boats.

BALL & SOCKET PIVOT DESIGN

The newest TACO innovation is the Intelli-Hinge. This unique innovation offers boat designers unprecedented design flexibility and versatility. The unique ball and socket pivot point permits hinging on a variety of surfaces regardless of the contour, including concave, convex and multiple plane surfaces. The unique design of the Intelli-Hinge allows it to perform in applications where conventional hinges simply cannot function.

TACO STOCKING PROGRAM

All TACO hinges, latches and accessories featured in this catalog are part of TACO's industry leading stocking program, which offers competitive pricing, a wide assortment of product and stocked inventory to ensure ready availability. For specialized applications TACO will design or customize a hinge or latch to meet specific requirements.

Hinges

31	Continuous Hinges
32	Utility Hinges
35	Specialty Hinges
36	Latches
37	Lifting Handles - LATCH-tite™
39	Specialty Hardware

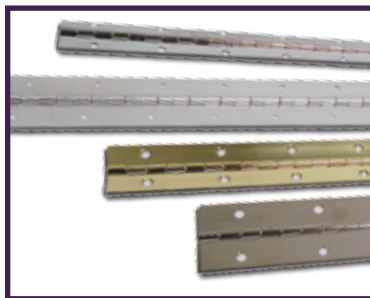

Continuous Hinges

- A superior movable fastener to hinge lids and hatches
- Offered in stainless steel type 304 with annealed or polished finish and in aluminum with a mill finish
- Customized lengths, holes, configurations and finishes are available

Stainless Steel Type 304

Annealed Finish

- 1/2" knuckle length

Bulk	Retail	Length	Width	Gauge	Screw	Style
H14-0112A72	H14-0112A72-1	72"	1-1/2"	.040"	#6 [▼]	E
H14-0114A72	H14-0114A72-1	72"	1-1/4"	.040"	#5 [▲]	E
H14-0116A72	H14-0116A72-1	72"	1-1/16"	.040"	#5 [▲]	E
H14-0200A72	H14-0200A72-1	72"	2"	.040"	#6 [▼]	E
H14-0300D96A [*]	-	96"	3"	.070"	#6 [▼]	G

^{*}1" knuckle length; .281" x .562" slots [▼].235" diameter hole size [▲].215" diameter hole size

Polished Finish

- 1/2" knuckle length

Bulk	Retail	Length	Width	Gauge	Screw	Style
H14-0112P72	H14-0112P72-1	72"	1-1/2"	.040"	#6 [▼]	E
H14-0114P72	H14-0114P72-1	72"	1-1/4"	.040"	#5 [▲]	E
H14-0116P72	-	72"	1-1/16"	.040"	#5 [▲]	E
H14-0200P72	-	72"	2"	.040"	#6 [▼]	E

[▼].235" diameter hole size [▲].215" diameter hole size

Aluminum

Mill Finish

- 1/2" knuckle length • .188" diameter hole size

Retail	Length	Width	Gauge	Style
H11-1126D72-1	72"	1-1/2"	.060"	A
H11-1144D72-1	72"	1-1/4"	.040"	A
H11-2006D72-1	72"	2"	.060"	A

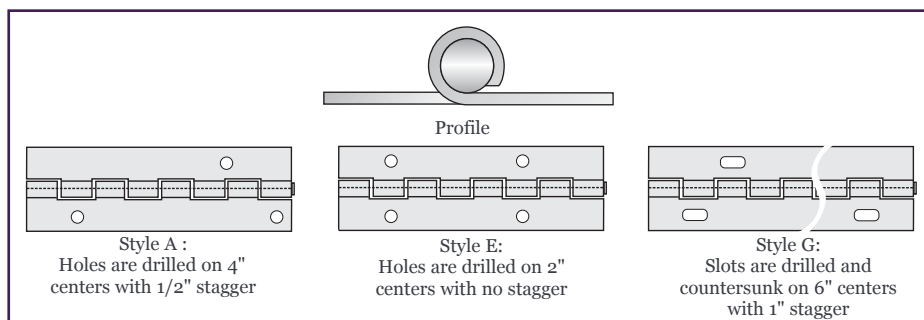
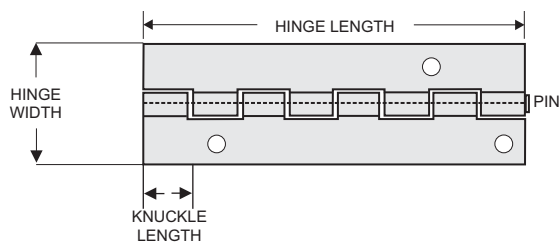



Utility Hinges

- Features stainless steel type 304 and 316
- Offered in a variety of styles and gauges

FEATURE PRODUCT

Intelli-Hinge

Patent-pending design offers unprecedented flexibility.

- › *Integrated ball-&-socket pivot point allows pivoting on concave, convex and multiple-plane surfaces*
- › *Hinges from any two sides, unlike conventional fixed-axis hinges*
- › *Low-profile Euro styling enhances the look of any boat*
- › *Polished stainless steel type 316 and Delrin insert prevent corrosion, galling and eliminates rattling*

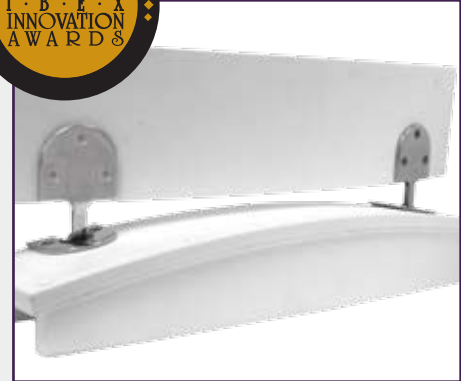

Intelli-Hinge permits hinging concave surfaces

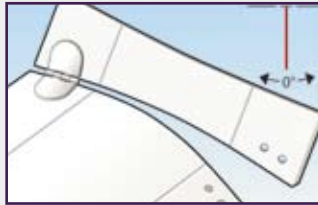

Conventional hinge unable to perform

Hatch Hinges

Cast Stainless Steel Type 316

Intelli-Hinge

- Hinges from any two sides • Deluxe polished • Offers 20° range of motion



H90-0400

Bulk	Length	Open Width	Gauge	Screw
H90-0400	2"	4"	0.10"	#8

Traditional Style

- Deluxe polished • Sold in pairs



H30-1050



H30-1060



H30-1070



H30-1080

Bulk	Retail	Pin Length	Open Width	Gauge	Screw
H30-1050	H30-1050-1	1-1/2"	3"	.125"	#10
-	H30-1060-1	1-1/2"	4"	.125"	#10
H30-1070	H30-1070-1	1-1/2"	2-1/4"	.125"	#10
H30-1080	H30-1080-1	1-1/2"	3"	.125"	#10

Cast Stainless Steel Type 304

Euro Style

- Heavy gauge • Electro polished • A variety of styles and sizes available



H23-0092



H23-0157



H23-1490



H23-1499 reverse pin



H23-4000

Bulk	Pin Length	Open Width	Gauge	Screw
H23-0092	3"	3"	.078"	#12
H23-0157	1-9/16"	2-3/4"	.078"	#10
H23-1490	1-1/2"	3"	.078"	#10
H23-1499	1-1/2"	3"	.078"	#10
H23-4000	1-1/2"	3-3/4"	.098"	#10

Economy Style

- Electro polished



H21-0232



H21-0233



H21-0234

Bulk	Pin Length	Open Width	Offset	Gauge	Screw
H21-0232	1-1/2"	2"	-	.060"	#8
H21-0233	1-1/2"	1-5/8"	3/8"	.060"	#8
H21-0234	1-1/2"	2-3/4"	-	.060"	#8

Butt Hinges

Cast Stainless Steel

Traditional Style

- Stainless steel type 316 • Rectangular shape excellent for cabinets • Sold in pairs

Bulk	Pin Length	Open Width	Gauge	Screw
H30-1040	2"	2"	.125"	#10



H30-1040

Euro Style

- Stainless steel type 304 • Euro design with electro polished finish

Bulk	Pin Length	Open Width	Gauge	Screw
H22-1550	1-1/2"	2-1/4"	.078"	#8



H22-1550

Hinges & Latches

Economy Style

- Stainless steel type 304 • Electro polished



H20-0112 • H20-0200 H20-0212 • H21-0133 H20-0230 H20-0300 H21-0132

Bulk	Retail*	Pin Length	Open Width	Offset	Gauge	Screw
H20-0112	H20-0112-1	2"	1-1/2"	-	.060"	#8
H20-0200	-	2"	2"	-	.060"	#8
H20-0212	-	2"	2-3/16"	3/8"	.060"	#8
H20-0230	-	3"	2"	-	.060"	#8
H20-0300	-	3"	3"	-	.060"	#10
H21-0132	H21-0132-1	1-1/2"	1-5/16"	-	.060"	#8
H21-0133	-	1-1/2"	15/16"	3/8"	.060"	#8

*Blister pack (pair)

Strap Hinges

Cast Stainless Steel

Traditional Style

- Stainless steel type 316 • Traditional deluxe polished hinges • Great for doors & hatches • Sold in pairs



H30-1010 H30-1020

Bulk	Pin Length	Open Width	Gauge	Screw
H30-1010	1"	4"	.125"	#10
H30-1020	1"	6"	.125"	#10

Economy Style

- Stainless steel type 304 • Electro polished



H21-0400 H21-0434 H21-0600 H21-0632

Bulk	Pin Length	Open Width	Gauge	Screw
H21-0400	1-1/2"	4"	.060"	#8
H21-0434	1-1/16"	3-15/16"	.060"	#8
H21-0600	1-1/2"	6"	.060"	#8
H21-0632	1-1/2"	4-5/16"	.060"	#8



Specialty Hinges

- Stainless steel type 316
- Ideal for doors, hatch and security

Bi-Fold Door Hinge

Traditional Style

- Ideal for closet and pantry bi-fold doors • Electro polished

Bulk	Pin Length	Open Width	Gauge	Screw
H20-0320	4"	2"	.090"	#10



H20-0320

Take-Apart Hinge

Traditional Style

- Allows hatch or door to be removed for easy entry • Typically used on hatches & engine boxes • Deluxe polished

Bulk	Pin Length	Open Width	Gauge	Screw
H30-1090L	1-1/2" (Left)	3-1/2"	.125"	#10
H30-1090R	1-1/2" (Right)	3-1/2"	.125"	#10



H30-1090L



H30-1090R

Hasps

Traditional Style Swivel Lock

- Swivels to secure latch • Hidden fastener for security • Allows for addition of lock • Over-sized hinge pins for added security
- Deluxe polished

Bulk	Retail*	Pin Length	Open Width	Gauge	Screw
H30-1015	H30-1015-1	1"	3"	.125"	#6

*Blister pack (each)



H30-1015



Latches

- High performance latches
- Rugged construction
- Positive locking features

Sundeck Latch

Plastic & Stainless Steel Type 316

- Low profile • Concealed latches • Non-slip grip • Positive locking
- Ideal for engine hatches, access panels, dock boxes, folding seats, leaning posts, large seats

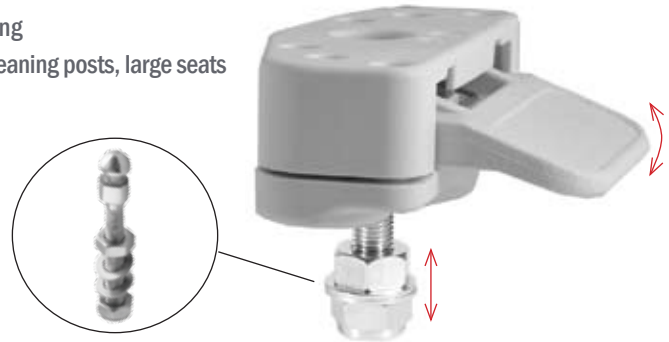

F45-0339W

Bulk	Retail*	Description
F45-0339B	-	Black Plastic Latch Handle & 2-3/4"L Stainless Steel Locking Pin
F45-0339W	F45-0339W-1	White Plastic Latch Handle & 2-3/4"L Stainless Steel Locking Pin

*Blister pack (each)

Stainless Steel Type 316

- Offered in two sizes - standard and long • Includes hex and lock nuts

Bulk	Description
F45-0336/0339B-3	2-3/4" Stainless Steel Locking Pin w/Hex Nut & Lock Nut
F45-0336/0339B-4	3-3/4" Stainless Steel Locking Pin w/Hex Nut & Lock Nut



F45-0336/0339B

Walk-Thru Windshield Latch

Stamped Stainless Steel Type 316

- Attaches to front deck and windshield door frame • Positive spring lock feature • Electro polished

Bulk	Description	Screw
F16-2900	1" x 2" Deck Mount Area • 5/8" x 1" Door Mount Area	#8

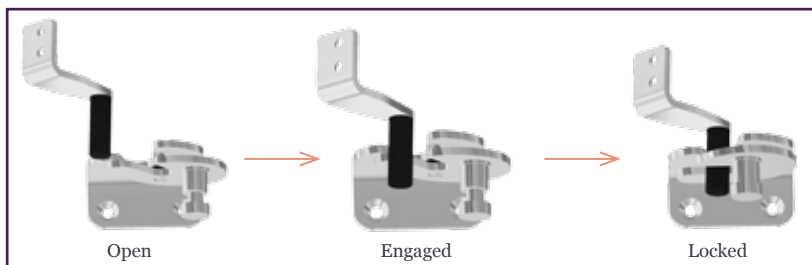

F16-2900



Lifting Handles - LATCH-tite™

- Complete line of high performance, trouble-free, anti-rattle handles
- Excellent water penetration protection
- Perfect for dry storage, electronics boxes and hatches of all types

FEATURE PRODUCT

LATCH-tite™

LATCH-tite™ handles have been designed to provide high performance, trouble free use in the most hostile conditions.

The latches are made from stainless steel type 316 or injection molded glass reinforced nylon.

All shafts and tongues are made from stainless steel type 316.

Round, square and rectangular designs enhance any marine craft. Latches can be installed vertically or horizontally, making them ideal for any opening.

The LATCH-tite series is for applications that require a heavy-duty, high performance construction and high quality appearance.

- › Unique patented stainless steel shaft with bushing and twin Nitrile "O" rings for greater protection against water penetration
- › Over center anti-rattle handles provide quiet operation
- › Concealed fasteners available
- › Mold plugs available upon request for boat builders

LATCH-tite™
High Performance Lifting Handles

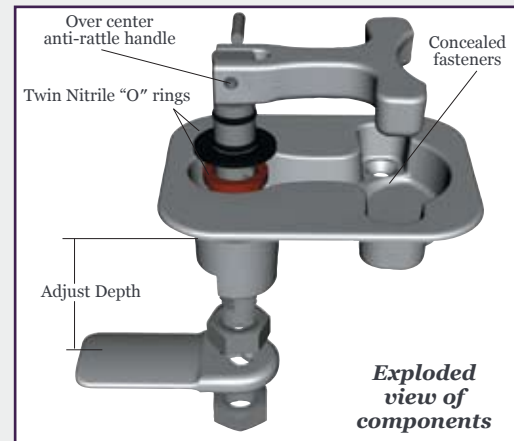

Hinges & Latches

Nylon Lifting Handles

Glass Reinforced Resin

- Fits into 2" Hole • Drilled and countersunk #8
- Edge thickness 1/8"



F42-2500
(Nylon handle)



F42-2500
(Stainless steel handle)

Bulk*	Retail†	Dimension	Base Color	Handle Color	Adj. Depth	Hole	Overall Depth
F42-2500BKA	F42-2500BKA-1	2-1/2" Diameter	Black	Black Nylon	1-3/4"	2"	2-5/16"
F42-2500BKSS	F42-2500BKSS-1	2-1/2" Diameter	Black	Polished Stainless Steel	1-3/4"	2"	2-5/16"
F42-2500WHA	-	2-1/2" Diameter	White	White Nylon	1-3/4"	2"	2-5/16"
F42-2500WHSS	F42-2500WHSS-1	2-1/2" Diameter	White	Polished Stainless Steel	1-3/4"	2"	2-5/16"

*Uses backing plate: F42-2999WRX †Backing plate included in retail blister packaging

Stainless Steel Type 316

Round

- Low profile design ensures flush mounting • Concealed fasteners • Deluxe polished



F16-2500



F16-3000 • F16-4000



F16-3500

Bulk	Retail*	Dimension	Edge Thickness	Adj. Depth	Hole	Overall Depth	Screw
F16-2500	F16-2500-1 [▼]	2-1/2" Diameter	5/32"	1-3/4"	2-1/16"	2-5/8"	#8
F16-3000	-	3" Diameter	3/32"	2-7/8"	2-9/16"	3-13/16"	#8
F16-3500	F16-3500-1	3-1/2" Diameter	5/32"	2-1/2"	3"	3"	#10

*Backing plate included in retail packaging *Blister pack (each)

Square/Rectangle



F16-2275



F16-2375



F16-2525



F16-3026 • F16-3040



F16-3041

Bulk	Retail*	Dimension	Edge Thickness	Adj. Depth	Hole	Overall Depth	Screw
F16-2275	F16-2275-1	2-1/8" x 3-1/6"	5/32"	1-3/4"	1-3/4" x 2-3/4"	2-5/16"	#8
F16-2375*	-	2-7/8" x 3-5/8"	5/32"	2-1/2"	2-5/16" x 3-1/8"	3-1/4"	#10
F16-2525	F16-2525-1 [▼]	2-7/16" x 2-7/16"	5/32"	1-3/4"	2-1/16"	2-5/16"	#8
F16-3026	-	2-1/2" x 3"	3/32"	2-7/8"	2-1/16" x 2-5/8"	3-1/8"	#8
F16-3040	-	3" x 4"	3/32"	2-7/8"	2-5/8" x 3-3/8"	3-1/2"	#10
F16-3041*	-	3-1/16" x 3-11/16"	3/32"	2-7/8"	2-3/4" x 3-3/8"	3-5/8"	#10

*Lockable *Concealed fasteners [▼]Backing plate included in retail packaging *Blister pack (each)



Specialty Hardware

- Durable, stainless steel type 304 and type 316 assorted hardware
- Lifting rings, door snaps and folding bracket

Lifting Ring

- Offered a variety of styles



F16-0021



F16-1812



F16-1853

Bulk	Retail*	Description	Screw
F16-0021	-	1-1/4" Diameter x 2-1/8"L	-
F16-1812	-	2" x 2-3/8" x 3/8"D	#6
F16-1853	F16-1853-1	2-1/8" Diameter	#6

*Blister pack (each)

Grab Handle

- Cast stainless steel type 316 • Deluxe polished

Bulk	Retail*	Hole	Height	Length
F16-1090*	F16-1090-1	1/4"	1-5/8"	6"

*1-5/8" clearance from deck *Blister pack (each)



F16-1090

Door Snap

- Electro polished • Secures doors • Ideal for cabinet, head and stateroom doors

Bulk	Description	Screw
H24-2850	1-5/16" Open Width	#6



H24-2850

Folding Bracket

- Electro polished • Ideally suited for jumpseats and fold-out tables • Stays locked when folded • Long release arm for easy reach
- Radiused back plate for use on tube or flat surface

Bulk	Description	Gauge	Screw
H24-7660	12-1/8" Open Width	.060"	#6



H24-7660

Fabrication

TACO Metals knows “metals”. For over 50 years, TACO has supplied boat builders and marine fabricators with high quality metal products. From tower to deck, bow to stern, TACO products can be found on boats world wide.

All products use the finest materials including prime billet anodized aluminum and marine grade stainless steel type 304 and 316 to ensure consistency, high quality and longevity.

- » Pipe and Tube is available in aluminum and marine grade stainless steel
- » Top and Tower Hardware including anodized aluminum angles, pads, pins and extrusion plates
- » Weld-On and Accessory-Ready Rod Holders offered in a variety of sizes for accessorizing tops, towers, arches and poling platforms
- » Accessory-Ready Adapters and Accessories offer unprecedented accessorizing capabilities
- » Canvas Top Fittings and Upholstery Hardware including polished stainless steel Ball and Socket rattle-free fittings
- » Complete Fabrications including T-tops and Leaning Posts
- » Stainless Steel Railing and Rail Fittings in a variety of materials

COMPLETE FABRICATIONS

TACO Metals has expanded its marine fabrication products to include complete fabrications that enable customers to add to their product lines without increasing overhead costs. TACO's Neptune product line includes OEM-quality Leaning Posts and T-tops that allow fabricators to offer additional quality fabrications and focus their time, labor and materials on other custom products.

ACCESSORY-READY™

Accessory-Ready is an innovative approach to boat accessorizing that offers unprecedented flexibility for the fabricator, boat dealer and ultimately the boater. Accessory-Ready includes a comprehensive group of adapters that can be incorporated into new or existing fabrications and offers interchangeable accessorizing and personalization of a boat.

Patent-pending male and female Accessory-Ready adapters are designed with specially engineered “splines” which mate for secure mounting of accessories and allow for adjustable positioning and removability.

Marine



41	Pipe & Tube
46	T-top & Tower
51	Wake Towers
52	Rod Storage
54	Accessory-Ready™
56	Shades & T-tops
58	Leaning Posts
61	Bimini & Canvas Tops
66	Railing



Pipe & Tube

- Offered in anodized aluminum
- Round, oval and square with a variety of finishes for interiors and exteriors
- Designed for tops and more

Pipe – Aluminum

Schedule 40

- Designed for T-tops, towers, leaning posts, poling platforms and bow rails • Extruded to close tolerances

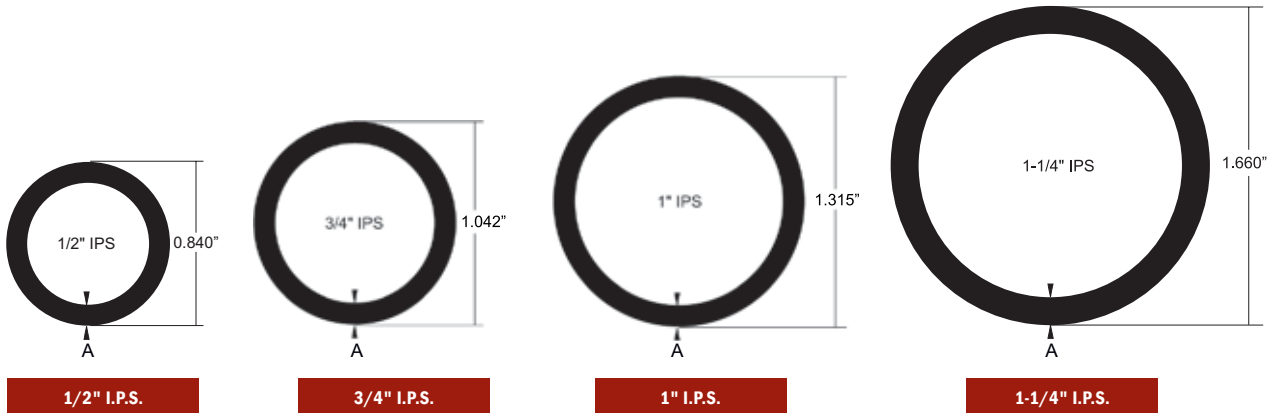

Bulk	I.P.S.	Outside Dia.	"A"	Length	Finish
A45-0351BSA23-M	1/2"	.840"	.109"	23'	320 Grit Brite Anodized
A45-0351BXY23-M	1/2"	.840"	.109"	23'	Polished Brite Anodized
A45-0352AEY20-A	3/4"	1.042"	.113"	20'	Mill
A45-0352BSA23-M	3/4"	1.042"	.113"	23'	320 Grit Brite Anodized
A45-0352BXY23-M	3/4"	1.042"	.113"	23'	Polished Brite Anodized
A45-0353AEY20-A	1"	1.315"	.133"	20'	Mill
A45-0353BSA23-M	1"	1.315"	.133"	23'	320 Grit Brite Anodized
A45-0353BXY23-M	1"	1.315"	.133"	23'	Polished Brite Anodized
A45-0354AEY20-A	1-1/4"	1.660"	.140"	20'	Mill
A45-0354BSA23-M	1-1/4"	1.660"	.140"	23'	320 Grit Brite Anodized
A45-0354BXY23-M	1-1/4"	1.660"	.140"	23'	Polished Brite Anodized
A45-0355AEY20-A	1-1/2"	1.900"	.145"	20'	Mill
A45-0355BSA23-M	1-1/2"	1.900"	.145"	23'	320 Grit Brite Anodized
A45-0355BXY23-M	1-1/2"	1.900"	.145"	23'	Polished Brite Anodized
A45-0356AEY20-A	2"	2.375"	.154"	20'	Mill
A45-0356BSA23-M	2"	2.375"	.154"	23'	320 Grit Brite Anodized
A45-0356BXY23-M	2"	2.375"	.154"	23'	Polished Brite Anodized

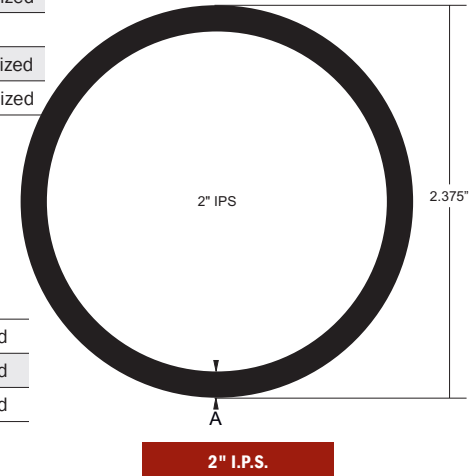
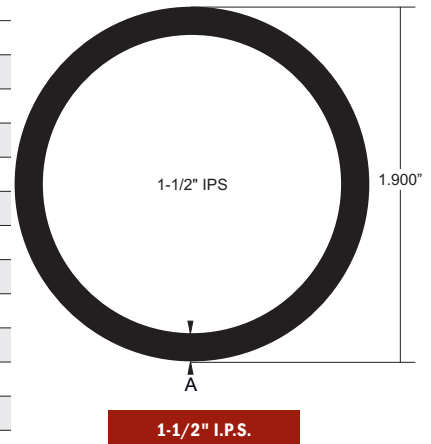

Schedule 80

- Strong, heavy-duty • Ideal for ski arches & towers

Bulk	I.P.S.	Outside Dia.	"A"	Length	Finish
A45-8354BXY23-M	1-1/4"	1.660"	.191"	23'	Polished Brite Anodized
A45-8355BXY23-M	1-1/2"	1.900"	.200"	23'	Polished Brite Anodized
A45-8356BXY16-M	2"	2.375"	.218"	16'	Polished Brite Anodized

Please refer to page REF100-101 for conversion, color and finish information

Call 800.226.8201 Boat Builders & Accessory Manufacturers
Call 800.653.8568 Aftermarket Distributors
TACOMarine.com



MF41

Oval Pipe

- Ideal for step treads, grab rails, bow rails, canvas top and other applications

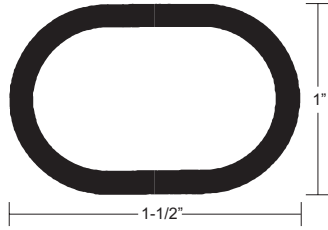

A42-0054

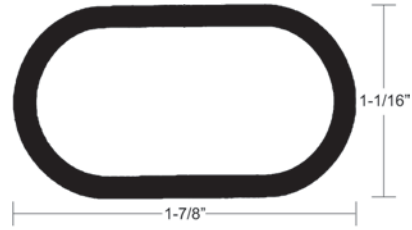

A42-0055



A42-0136

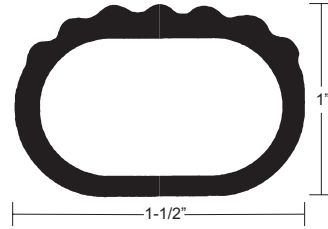

A42-0195

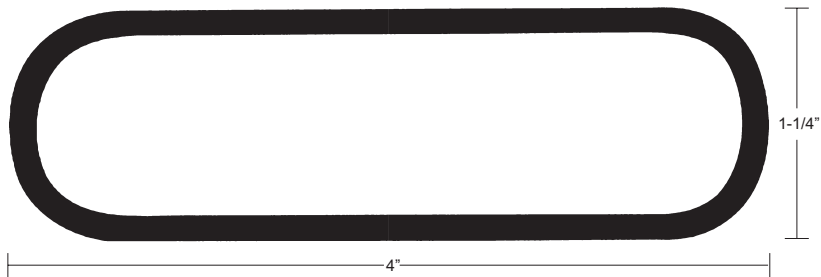

A42-0382

Bulk	Height	Width	Wall	Length	Finish
A42-0054AEY20	1"	1-1/2"	.125"	20'	Mill
A42-0054BSA20*	1"	1-1/2"	.125"	20'	320 Grit Brite Anodized
A42-0054BXY20	1"	1-1/2"	.125"	20'	Polished Brite Anodized
A42-0055BSA20*	1-1/16"	1-7/8"	.125"	20'	320 Grit Brite Anodized
A42-0055BXY20	1-1/16"	1-7/8"	.125"	20'	Polished Brite Anodized
A42-0136AEY20	1-1/4"	3"	.140"	20'	Mill
A42-0136BSA20*	1-1/4"	3"	.140"	20'	320 Grit Brite Anodized
A42-0136BXY20	1-1/4"	3"	.125"	20'	Polished Brite Anodized
A42-0195BXY20	1"	1-1/2"	.140"	20'	Polished Brite Anodized
A42-0382BSA20*	1-1/4"	4"	.140"	20'	320 Grit Brite Anodized
A42-0382BXY20	1-1/4"	4"	.140"	20'	Polished Brite Anodized

*320 Grit finish on flat surface only

Please refer to page REF100-101 for conversion, color and finish information



Call 800.226.8201 Boat Builders & Accessory Manufacturers
 Call 800.653.8568 Aftermarket Distributors
TACOMarine.com

Oval Pipe “Sure Step”

- Adds stepping ability to a variety of pipe fabrications, including tuna towers, poling and swim platforms

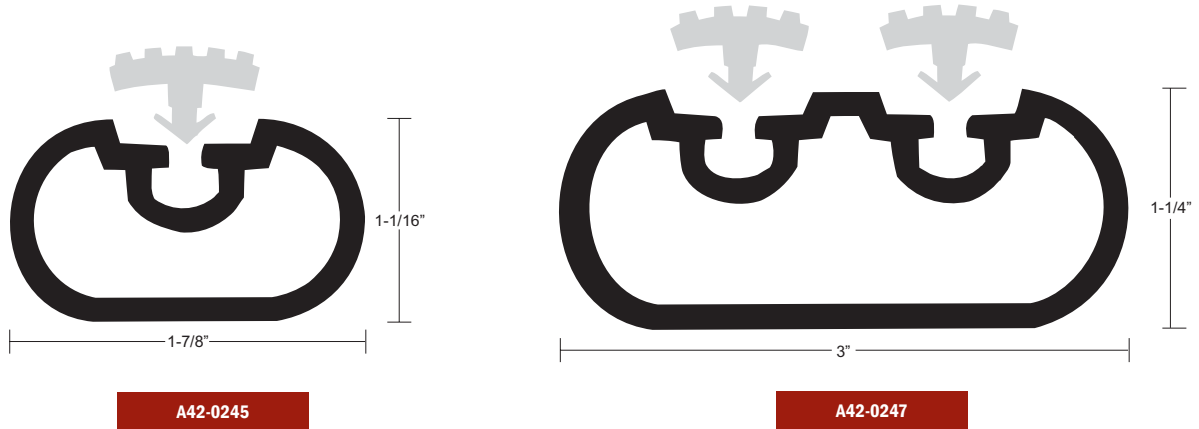

Bulk	Height	Width	Length	Finish	Insert
A42-0245BXY20	1-1/16"	1-7/8"	20'	Polished Brite Anodized	V12-5817
A42-0247BXY20	1-1/4"	3"	20'	Polished Brite Anodized	V12-5817

Marine Fabrication

“Sure Step” Pipe Inserts

- Flex PVC rubber blend increases traction to provide the ultimate “sure step”



Bulk	Length	Color
V12-5815BKA50	50'	Black
V12-5817BKA50	50'	Black

Please refer to page REF100-101 for conversion, color and finish information

Call 800.226.8201 Boat Builders & Accessory Manufacturers
 Call 800.653.8568 Aftermarket Distributors
TACOMarine.com



Structural – Aluminum

Angles – Radius Edge

- Extruded for maximum strength • Designed for a wide variety of marine fabrications

Bulk	Height	Width	Thickness	Length	Finish
A42-1043BXY20	2"	2"	1/4"	20'	Polished Brite Anodized

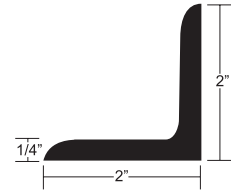

A42-1043

Flat Bar - Square Edge

- Designed for structural use and mounting brackets on all fabricated applications

Bulk	"A"	"B"	Length	Radius	Finish
A40-0843BSA12	3/8"	4"	12'	.016"	320 Grit Brite Anodized
A42-0363BSA12	1/4"	2"	12'	.031"	320 Grit Brite Anodized
A42-0363BXY12	1/4"	2"	12'	.031"	Polished Brite Anodized
A42-0364BSA12	1/4"	3"	12'	.031"	320 Grit Brite Anodized
A42-0364BXY12	1/4"	3"	12'	.031"	Polished Brite Anodized
A42-0365BSA12	1/4"	4"	12'	.031"	320 Grit Brite Anodized
A42-0365BXY12	1/4"	4"	12'	.031"	Polished Brite Anodized



Flat Bar - Square Edge

Flat Bar – Full Radius Edge

- Provides seat-back support • Also used on leaning posts and grab rails • Full radius edge

Bulk	"A"	"B"	Length	Finish
A40-0822AEY10	1/2"	2"	10'	Mill
A40-0822BXY12	1/2"	2"	12'	Polished Brite Anodized
A40-0861BXY12	3/8"	2"	12'	Polished Brite Anodized
A40-1132BXY14	1/2"	1-1/2"	14'	Polished Brite Anodized



Flat Bar - Radius Edge

Mini Plates

- Anodized in convenient sizes for handling • Makes pads, brackets and support braces ready to weld

Bulk	Width	Thickness	Length	Finish
A44-4248BSY	24"	1/4"	48"	180 Grit Brite Anodized



A44-4248

Please refer to page REF100-101 for conversion, color and finish information

Tube – Aluminum

Square & Rectangular

- Improves strength and structural integrity of marine fabrications • Corners radiused .152"

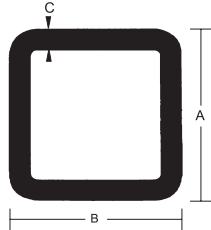

A42-0360

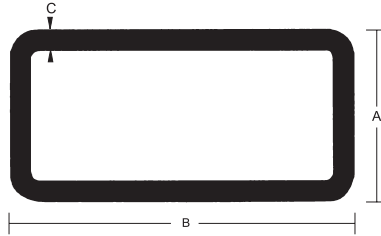

A42-0361

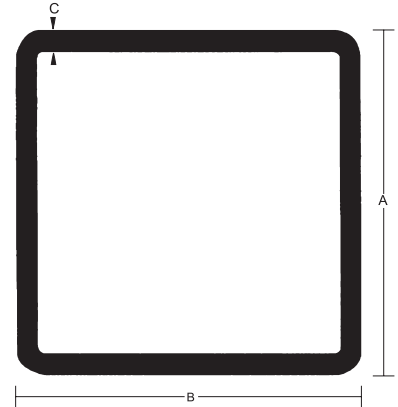

A42-0362

Bulk	"A"	"B"	"C"	Length	Finish
A42-0360BXY24	1"	1"	.125"	24'	Polished Brite Anodized
A42-0361AEY24	1"	2"	.125"	24'	Mill
A42-0362BXY24	2"	2"	.125"	24'	Polished Brite Anodized

Drawn

- Drawn to close tolerances for consistent use with rail and top fittings • Offers superior strength over extruded tube

Bulk	Retail	"A"	Wall	Length	Finish
A23-3458BLY20	-	3/4"	.058"	20'	Brite Anodized
-	A23-3458BLY6-1	3/4"	.058"	6'	Brite Anodized
A23-7858BLY12	A23-7858BLY12-1	7/8"	.058"	12'	Brite Anodized
A23-7858BLY16	-	7/8"	.058"	16'	Brite Anodized
A23-7858BLY20	A23-7858BLY20-1	7/8"	.058"	20'	Brite Anodized
A23-7858BLY24	-	7/8"	.058"	24'	Brite Anodized
-	A23-7858BLY6-1	7/8"	.058"	6'	Brite Anodized
A23-7895BLY24	-	7/8"	.095"	24'	Brite Anodized

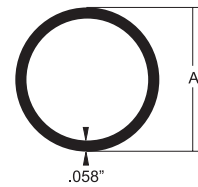

A23-3458 • A23-7858

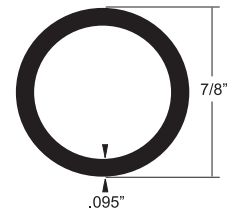

A23-7895

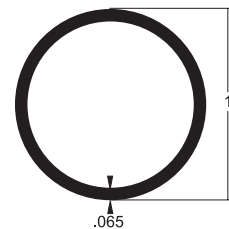

A20-1464

Extruded

Bulk	Outside Dia.	Wall	Length	Finish
A20-1464BLY20	1"	.065"	20'	Brite Anodized

Please refer to page REF100-101 for conversion, color and finish information

Call 800.226.8201 Boat Builders & Accessory Manufacturers
Call 800.653.8568 Aftermarket Distributors
TACOMarine.com





T-top & Tower

- Structured extrusions and machined pads and pins
- High-quality anodized aluminum materials in a variety of finishes

FEATURE PRODUCT

TACO's Outrigger-Ready Program

Available for use on all tops.

- › Pre-drilled, weld-on extrusion plates save time and add value through the distribution channel
- › Eliminate the need for special-order packages and reduce boat inventories



Structural – Aluminum

Multi Function T-top Extrusion Plates

- Heavy-duty, suited for a variety of applications and widely used for outrigger mounts
- Offered pre-drilled for easy mounting of Grand Slam 270 and 370 outrigger mounts
- Choice of low profile and T-top pipe height
- Conceals wiring
- Sold in pairs

The GSE-1940

features larger channels for running all co-axial and power cables from T-top lighting, antennas and electronics.

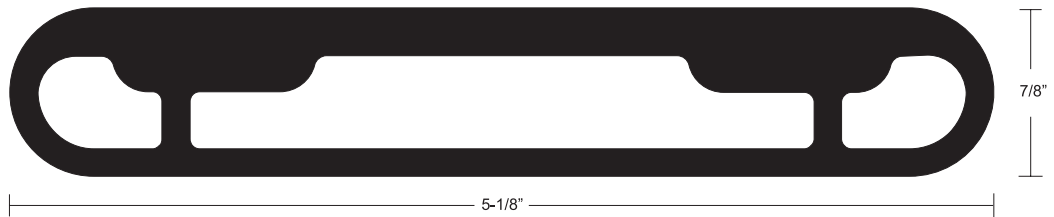
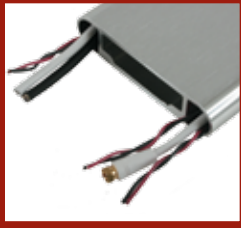

GSE-1939

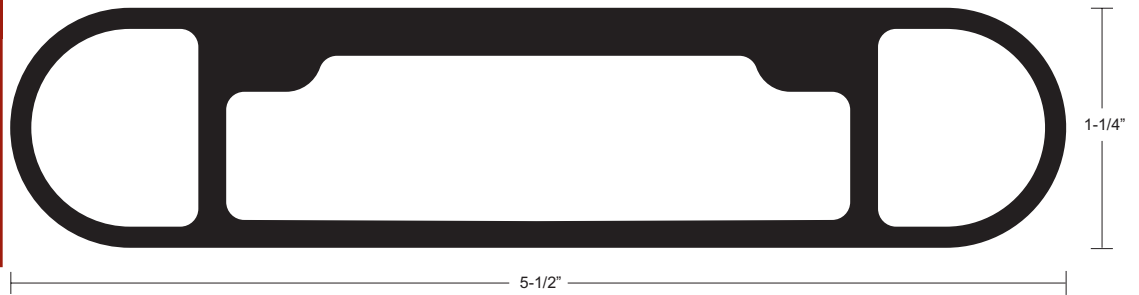

GSE-1940



Patent #6,851,654

GSE-1939



GSE-1940

Bulk	Retail	Description	Height	Width	Length	Finish
-	GSE-1939BXY30-1	Pre-Drilled Grand Slam Eextrusion	7/8"	5-1/8"	30"	Polished Brite Anodized
GSE-1939BLS30	-	Pre-Drilled Grand Slam Extrusion	7/8"	5-1/8"	30"	Linear Sanded
GSE-1940BSA32	-	Pre-Drilled Grand Slam Extrusion Plate w/Wide Channels	1-1/4"	5-1/2"	30"	320 Grit Brite Anodized

Please refer to page REF100-101 for conversion, color and finish information



Call 800.226.8201 Boat Builders & Accessory Manufacturers
Call 800.653.8568 Aftermarket Distributors
TACOMarine.com

Pins - Aluminum

Male & Female

- High-quality, precision fittings machined from 6000 series solid aluminum for strength and anodized for long-lasting durability
- Counter-bored with an air release hole to ensure fast preparation and consistent welding

Male Pins

Bulk	I.P.S.	Hole	Finish
F30-1821BLY	3/4"	1/4"	Brite Anodized
F30-1831BLY	1"	5/16"	Brite Anodized
F30-1841BLY	1-1/4"	3/8"	Brite Anodized
F30-1851BLY	1-1/2"	3/8"	Brite Anodized



Male Pin

Female Pins

Bulk*	I.P.S.	Bolt	Finish
F30-1823BLY	3/4"	1/4"	Brite Anodized
F30-1833BLY	1"	5/16"	Brite Anodized
F30-1843BLY	1-1/4"	3/8"	Brite Anodized
F30-1853BLY	1-1/2"	7/16"	Brite Anodized
F30-2150BLY	1-1/2"	3/8"	Brite Anodized

*Includes 2 Delrin washers for extra smooth rotation



Female Pin

Breakaway

- High-quality, precision fittings machined from 6000 series solid aluminum stock for strength and anodized for long lasting durability
- All TACO pins are counter bored with an air release hole to ensure fast preparation and consistent welding

Bulk	I.P.S.	Bolt	Finish
F30-2300BLY	1"	5/16"	Brite Anodized
F30-2400BLY	1-1/4"	3/8"	Brite Anodized
F30-2500BLY	1-1/2"	3/8"	Brite Anodized



F30-2300

Alignment Pin Set

- Allows for pipe alignment adjustments

Bulk	I.P.S.	Finish
F30-3500BLY	1-1/2"	Brite Anodized



F30-3500

Please refer to page REF100-101 for conversion, color and finish information

Call 800.226.8201 Boat Builders & Accessory Manufacturers
Call 800.653.8568 Aftermarket Distributors
TACOMarine.com



Pads - Aluminum

Round 1/4" Thick

- High quality, precision machined pads • Solid, anodized 6000 series aluminum stock • Perfect for T-tops and towers
- Center bleed holes vent air during welding • 1/4" screw



F32-4025



F32-0900



F32-4330



F32-4440

Bulk	Outside Dia.	I.P.S.	Ctr. Hole	# of Holes	Finish
F32-4025BXY	2-1/2"	-	3/8"	0	Polished Brite Anodized
F32-0900BXY	5"	2"	2"	3	Polished Brite Anodized
F32-4325BXY*	2-1/2"	1/2"	3/8"	3	Polished Brite Anodized
F32-4330BSS	3"	3/4"	3/8"	3	Spiral Sanded
F32-4330BXY	3"	3/4"	3/8"	3	Polished Brite Anodized
F32-4335AEY	3-1/2"	1"	3/8"	3	Mill
F32-4335BSS	3-1/2"	1"	3/8"	3	Spiral Sanded
F32-4335BXY	3-1/2"	1"	3/8"	3	Polished Brite Anodized
F32-4340BSS	4"	1-1/4"	3/8"	3	Spiral Sanded
F32-4340BXY	4"	1-1/4"	3/8"	3	Polished Brite Anodized
F32-4345AEY	4-1/2"	1-1/2"	3/8"	3	Mill
F32-4345BSS	4-1/2"	1-1/2"	3/8"	3	Spiral Sanded
F32-4345BXY	4-1/2"	1-1/2"	3/8"	3	Polished Brite Anodized
F32-4350BSS	5"	2"	3/8"	3	Spiral Sanded
F32-4350BXY	5"	2"	3/8"	3	Polished Brite Anodized
F36-4340BXY-6	4"	1-1/4"	1-1/2"	3	Polished Brite Anodized
F36-4340BXY-8	4"	1-1/2"	1-5/16"	3	Polished Brite Anodized
F36-4345BXY-2	4-1/2"	1-1/2"	1-5/8"	3	Polished Brite Anodized
F32-4435AEY	3-1/2"	1"	3/8"	4	Mill
F32-4435BXY	3-1/2"	1"	3/8"	4	Polished Brite Anodized
F32-4440AEY	4"	1-1/4"	3/8"	4	Mill
F32-4440BSS	4"	1-1/4"	3/8"	4	Spiral Sanded
F32-4440BXY	4"	1-1/4"	3/8"	4	Polished Brite Anodized
F32-4445BSS	4-1/2"	1-1/2"	3/8"	4	Spiral Sanded
F32-4445BXY	4-1/2"	1-1/2"	3/8"	4	Polished Brite Anodized
F32-4450BXY	5"	2"	3/8"	4	Polished Brite Anodized
F32-4450BSS	5"	2"	3/8"	4	Spiral Sanded
F36-4440BXY-1 [▼]	4"	1-1/2" & 2"	3/8"	4	Polished Brite Anodized
F36-4440BXY-2 [▼]	4"	1-1/2" & 2"	1-1/2"	4	Polished Brite Anodized
F36-4440BXY-3 [▼]	4"	1-1/2" & 2"	1-5/8"	4	Polished Brite Anodized
F32-4550BXY	5"	2"	3/8"	5	Polished Brite Anodized

*#10 screw [▼]Offset hole configuration for swept back T-top legs [■]Tapped center hole is for screwing down on top of fiberglass - not for pipe



F32-4550



F36-4340



F36-4345



F36-4440-1



F36-4440-2

Please refer to page REF100-101 for conversion, color and finish information



Call 800.226.8201 Boat Builders & Accessory Manufacturers
Call 800.653.8568 Aftermarket Distributors
TACOMarine.com

Rectangular 1/4" Thick

- High quality, precision machined pads
- Solid, anodized 6000 series aluminum stock
- Applications include Leaning Posts, T-tops and tower legs
- Center bleed holes vent air during welding
- 1/4" screw

Bulk	Width	Length	I.P.S.	# of Holes	Finish
F36-2032BXY-2	2"	3-1/4"	1"	2	Polished Brite Anodized
F36-2035BXY-2	2"	3-1/2"	1"	2	Polished Brite Anodized
F36-2050BSY-320*	2"	5"	1"	2	320 Grit Brite Anodized
F32-1530BSY320	1-1/2"	3"	3/4"	4	320 Grit Brite Anodized
F32-2040BSY	2"	4"	1"	4	180 Grit Brite Anodized
F32-2040BXY	2"	4"	1"	4	Polished Brite Anodized
F32-3040BSY	3"	4"	1" & 1-1/4"	4	180 Grit Brite Anodized
F32-3040BXY	3"	4"	1" & 1-1/4"	4	Polished Brite Anodized

*No center hole

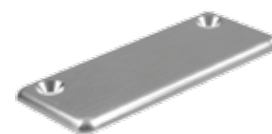

F36-2050



F36-2035



F32-3040

Male/Female Pad Assemblies

- High-quality, precision machined pads
- Solid, anodized 6000 series aluminum stock
- Counter-bored with air release to ensure fast preparation and consistent welding
- 1/4" screw with 4 holes

Bulk	Outside Dia.	I.P.S.	Style	Mating Pipe
F35-SDW100*	3-1/2"	1"	Female	F30-1831
F35-SDW125*	4"	1-1/4"	Female	F30-1841
F35-SDW150*	4-1/2"	1-1/2"	Female	F30-1851
F35-W304	3"	1/4"	Male	F30-1823
F35-W354	3-1/2"	1"	Male	F30-1833
F35-W404	4"	1-1/4"	Male	F30-1843 / F30-1853

*Includes 2 Delrin washers for extra smooth rotation



Female Pad Assembly



Male Pad Assembly

Marine Fabrication

Please refer to page REF100-101 for conversion, color and finish information

Call 800.226.8201 Boat Builders & Accessory Manufacturers
 Call 800.653.8568 Aftermarket Distributors
TACOMarine.com



Specialty Pads

Specialty 1/4" Thick

- High-quality, precision machined pads • Solid, anodized 6000 series aluminum stock • Variety of shapes and hole configurations
- Center bleed holes vent air during welding • 1/4" screw



Bulk	Width	Length	I.P.S.	Ctr. Hole	# of Holes	Style	Finish
F32-0600BSY	2"	3-3/4"	1"	1/4"	2	Diamond	180 Grit Brite Anodized
F32-0600BXY	2"	3-3/4"	1"	1/4"	2	Diamond	Polished Brite Anodized
F32-0650BXY	2"	3-1/2"	1"	1/4"	2	Diamond	Polished Brite Anodized
F32-0660BXY	1-15/16"	2-15/16"	1"	-	2	Tear Drop	Polished Brite Anodized
F36-2040BSY-320	2"	4-1/4"	1"	3/8"	2	Diamond	320 Grit Brite Anodized
F32-3043BSY-320	4-3/8"	3"	1-1/4" & 1-1/2"	3/8"	4	Rectangular	320 Grit Brite Anodized
F32-3043BXY	4-3/8"	3"	1-1/4" & 1-1/2"	3/8"	4	Rectangular	Polished Brite Anodized
F36-3040BXY-2	3"	4"	1" & 1-1/4"	1/2"	4	Rectangular	Polished Brite Anodized

Please refer to page REF100-101 for conversion, color and finish information



Call 800.226.8201 Boat Builders & Accessory Manufacturers
 Call 800.653.8568 Aftermarket Distributors
TACOMarine.com



Wake Towers

- Hardware for building and equipping wake towers and arches
- Anodized aluminum for added strength and long-lasting durability

Hardware - Aluminum



F30-1751



F30-1752



F30-1852



F30-2150



F30-2155



F30-2555



F36-7001



F40-0024

Bulk	Description	I.P.S.	Bolt	Style	Color	Finish
F30-1751BLY	Half Pin & Swivel Stud	1-1/2"	3/8"	Half Pin - 180° Rotation	-	Brite Anodized
F30-1752BLY	Half Pin & Swivel Stud	1-1/2"	3/8"	Tower Foot - 17°	-	Brite Anodized
F30-1852BLY	Half Pin & Swivel Stud	1-1/2"	3/8"	Male Pin - 180° Rotation	-	Brite Anodized
F30-2150BLY	Female Pin	1-1/2"	3/8"	Coped Base	-	Brite Anodized
F30-2155BLY	Half Pin & Swivel Stud	-	3/8"	Side Swivel Stud	-	Brite Anodized
F30-2555BLY	Wake Tower Pin	1-1/2"	3/8"	Break-Away Pin - 180° Rotation	-	Brite Anodized
F36-7001BLY	Ski Ball Assembly w/Delrin Insert	1-1/2"	-	-	-	-
F40-0024BLK	Soft Touch Knob & Stainless Steel Stud	-	3/8" x 1-1/2"	-	Black	-

Accessories - Aluminum

Clamp-On Wakeboard Rack

- Adjustable to fit 1-1/4" & 1-1/2" I.P.S. pipe



F36-7004

Bulk	Retail*	Description	I.P.S.
F36-7004BXY	F36-7004BXY-1	Clamp-on Aluminum Wakeboard Rack	1-1/4" & 1-1/2"

*Retail packaged & sold in pairs

Please refer to page REF100-101 for conversion, color and finish information

Call 800.226.8201 Boat Builders & Accessory Manufacturers
Call 800.653.8568 Aftermarket Distributors
TACOMarine.com





Rod Storage

- Rod storage for all size rods
- Offered in single and multiple rod storage
- Variety of materials and finish

FEATURE PRODUCT

TACO's Rod Holders - Superior by Design

TACO anodized aluminum rod holders are stocked in a variety of styles, sizes and finishes.

All TACO rod holders are anodized for lasting protection. Available in polished and brushed finish.

TACO rod holders with flared design allow for easy rod placement. Welded I-Beam pin construction seats rod butt securely in place and is proven to be 2-1/2 times stronger than competitive rod holders.

Specially formulated, fungal-resistant vinyl liners are tapered to fit snugly with rod holders.

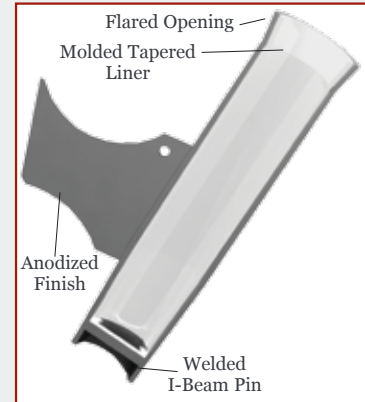

Rod Holders - Aluminum

Flared Weld-On

- Weld to towers, T-tops, radar arches, railings and leaning posts
- Welded I-Beam securely seats rod butt
- Anti-fungal vinyl liners
- 6463 aluminum, brite anodized



F31-2200
F31-2240 • F31-2300



F31-2220



F31-2230



F31-2320

Bulk	I.D.	Length	Liner	Blade	Finish
F31-2200BSA-4A	1-3/4"	9-3/4"	White	Bladeless	320 Grit
F31-2200BXY-4A	1-3/4"	9-3/4"	White	Bladeless	Polished
F31-2220BXY-4A	1-3/4"	9-3/4"	White	1-1/16" x 1-7/8" Oval Tube Blade	Polished
F31-2230BXY-4A	1-3/4"	9-3/4"	White	3/8" Coped Blade	Polished
F31-2240BXY-4A	1-3/4"	8-1/2"	White	Bladeless	Polished
F31-2300BXY-4	1-7/8"	10-1/4"	Black	Bladeless	Polished
F31-2320BXY-4	1-7/8"	10-1/4"	Black	3/8" Scalloped Blade	Polished

Please refer to page REF100-101 for conversion, color and finish information



Call 800.226.8201 Boat Builders & Accessory Manufacturers
Call 800.653.8568 Aftermarket Distributors
TACOMarine.com

Traditional Weld-On

- Non-flared design • Weld to towers, T-tops, radar arches, railings and leaning posts • 6463 aluminum anodized

Bulk	I.D.	Length	Insert	Style	Finish
F31-1500BXY-4	1-7/8"	10"	Black	-	Polished
F31-1600BXY-4A	1-1/2"	8-1/2"	White	-	Polished
F31-1610BXY-4A	1-1/2"	8-1/2"	White	Slotted	Polished

Slotted for Spinning Reels



F31-1610



F31-1500 • F31-1600

Leaning Post Deck Mount

- Feature the same welded pin design as weld-ons • Perfect for leaning post applications • 6463 aluminum anodized

Bulk	I.D.	Length	Angle	Finish
F31-0700BSY	1-1/2"	8-1/2"	10°	180 Grit
F31-0700BXY	1-1/2"	8-1/2"	10°	Polished



F13-0700

Leaning Post Weld-On

- Rectangular flange • Weld pin • 6463 aluminum anodized

Bulk	I.D.	Length	Angle	Finish
F31-0750BXY	1-1/2"	6"	10°	Polished
F31-0755BSY-320	1-1/2"	8"	15°	320 Grit



F31-0750



F31-0755

Marine Fabrication

Please refer to page REF100-101 for conversion, color and finish information

Call 800.226.8201 Boat Builders & Accessory Manufacturers
 Call 800.653.8568 Aftermarket Distributors
TACOMarine.com





Accessory-Ready™

- Allows for customization of fabrications quickly and without welding
- Welded aluminum male adapters offer quick change-out of rod holders and accessories
- Ideal for customizing selection, color and finish
- Rod holders and accessories remove easily with standard Allen wrench

FEATURE PRODUCT

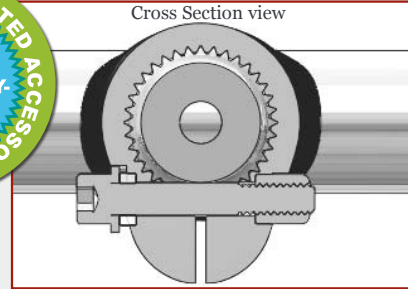
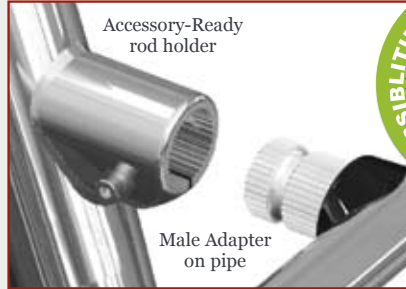

Male Weld-On Adapter & Accessories

- Welded in place on tops, bridges, arches and poling platforms for accessorizing
- Universal design fits 3/4" to 1-1/2" I.P.S. pipe

Bulk	Description	Color	Finish
F34-0110BLY	Male Adapter for I.P.S. Pipe	-	Brite Anodized
F40-0005BKA	Thumb Screw for Rod Holder	Black	Stainless Steel
F40-0006BKA	Male Spline Cap	Black	-
F40-0008BKA	Weld Cover for 3/4" I.P.S. Pipe	Black	-
F40-0010BKA	Weld Cover for 1" I.P.S. Pipe	Black	-



Male Spline w/ Weld Cover



Spline Cap



Weld Cover



Thumb Screw

Accessory-Ready Rod Holders

- Install, position and remove with a standard Allen wrench
- Available in polished, anodized aluminum and glass-reinforced nylon
- Fit all Accessory-Ready clamp-on and flush-mount male adapters
- Offered in sizes for standard and big-game rods

Bulk	Retail	I.D.	Blade	Length	Angle	Color	Finish
-	F31-2750BXY-1*	1-3/4"	2"	9-3/4"	20°	-	Polished
F31-2760BXY	-	1-3/4"	2"	9-3/4"	10°	-	Polished
-	F31-2790BXY-1	1-3/4"	2"	9-3/4"	90°	-	Polished
-	F31-2850BXY-1	1-7/8"	2"	10-1/4"	20°	-	Polished
-	F41-2750BKA-1	1-3/4"	2"	9-3/4"	20°	Black	-
-	F41-2750WHA-1	1-3/4"	2"	9-3/4"	20°	White	-

*Not recommended for use with Neptune III Leaning Post



F31-2750



F31-2760



F31-2790



F41-2750

Please refer to page REF100-101 for conversion, color and finish information



Call 800.226.8201 Boat Builders & Accessory Manufacturers
 Call 800.653.8568 Aftermarket Distributors
TACOMarine.com

Accessory-Ready Adapters

Male - Flush Mount

- Mount at any angle ideal for bulk heads, tops and transom
- Accept Accessory-Ready female adapters and TACO Accessory-Ready accessories
- Ideal for adding antennas, drink holders and cutting boards
- Offered in aluminum and plastic



F34-0600



P01-0600

Male - Clamp-On

- Clamp adjusts to fit two pipe sizes
- Polished anodized aluminum and rugged plastic
- Accepts Accessory-Ready accessories and female adapters



F36-2521



F41-2500WHA

Female - Surface Mount

- Heavy-duty female adapter makes any accessory Accessory-Ready
- Two mounting holes for attaching accessories



F34-0210



P01-0610

Female - Clamp-On

- Clamp adjusts to fit two pipe sizes
- Offered in 2 sizes for use on rings, legs and cross members
- Two mounting holes for attaching accessories



F34-0212 • F34-0213

Bulk	Description	Color	Finish
Male - Surface Mount			
F34-0600BXY-1	Aluminum Tear Drop Male Adapter	-	Polished
P01-0600W-1	Plastic Tear Drop Male Adapter	White	-
Male - Clamp-On			
F36-2521BXY-1	Accessory-Ready Clamp for 3/4" - 1" I.P.S. Pipe	-	Polished
F36-2531BXY-1	Accessory-Ready Clamp for 1-1/4" - 1-1/2" I.P.S. Pipe	-	Polished
F41-2500BKA-1	Accessory-Ready Plastic Clamp for 7/8" - 1" O.D. Tube	Black	-
F41-2520BKA-1	Accessory-Ready Plastic Clamp for 3/4" - 1" I.P.S. Pipe	Black	-
F41-2500WHA-1	Accessory-Ready Plastic Clamp for 7/8" - 1" O.D. Tube	White	-
F41-2520WHA-1	Accessory-Ready Plastic Clamp for 3/4" - 1" I.P.S. Pipe	White	-
Female - Surface Mount			
F34-0210BXY-1	Aluminum Female Adapter	-	Polished
P01-0610W-1	Aluminum Female Adapter w/Plastic Tear Drop Male Adapter	White	Polished
Female - Clamp-On			
F34-0212BXY-1	Female Adapter w/Male Clamp 3/4" - 1" I.P.S. Pipe	-	Polished
F34-0213BXY-1	Female Adapter w/Male Clamp 1-1/4" - 1-1/2" I.P.S. Pipe	-	Polished

Please refer to page REF100-101 for conversion, color and finish information

Call 800.226.8201 Boat Builders & Accessory Manufacturers
Call 800.653.8568 Aftermarket Distributors
TACOMarine.com





Shades & T-tops

- Neptune anodized aluminum tops for center consoles
- Lightweight adjustable-height canvas tops for shade
- Rugged OEM-style adjustable width T-tops for fishing boats
- Individually boxed and labeled for readily identifiable product contents and attractive retail merchandising

FEATURE PRODUCT

Neptune Adjustable Tele-Shade

- Combines the walkaround benefits of a T-top with the lightweight adjustability of a "Bimini Top"
- Add shade without obstructing deck & gunnels
- Mounts to center console for full walkaround access
- Telescopes from 4-1/2' to 7' for use with low profile consoles & boat storage
- Stainless steel locking buttons & pull pins for easy and secure height adjustments
- Adjust to fit consoles up to 46" W x 48" H
- Unique clamp-on assembly offers do-it-yourself installation with minimal tools required
- Anodized aluminum with satin finish for use in salt and freshwater environments
- Weighs only 30lbs.

Neptune
By TACO

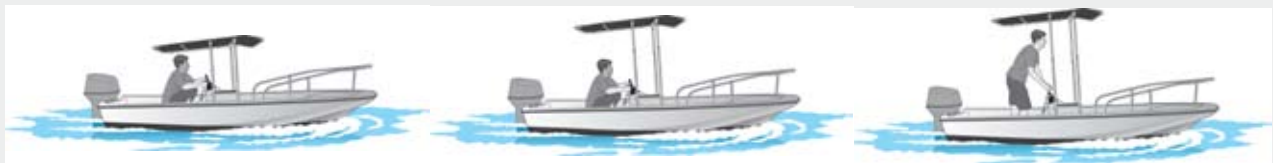
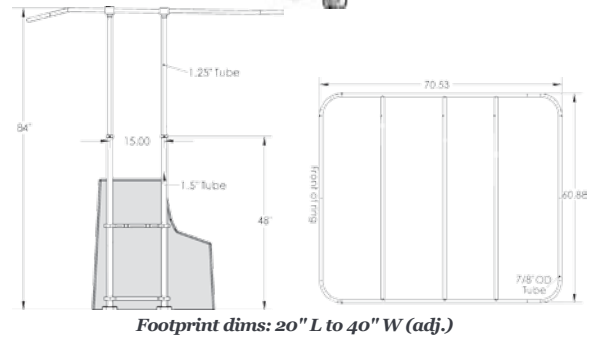
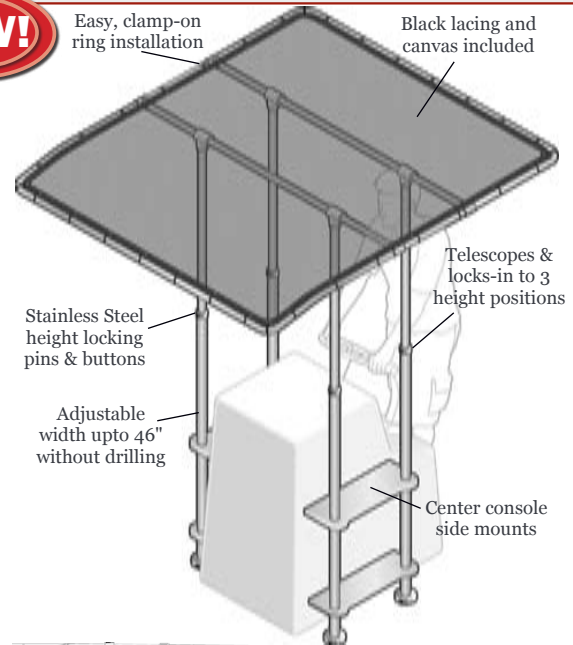

Fully retracted
for low profile consoles, trailer and storage

Intermediate height

Full height
for higher consoles

Neptune Tele-Shade

- Anodized aluminum • Satin finish • Stainless steel buttons and locking pins • Clamp-on assembly
- UV-resistant black canvas • Adjustable height

Bulk/Retail	Description
T34-2002VEL-1	Neptune Tele-Shade w/Black Canvas

Please refer to page REF100-101 for conversion, color and finish information



Call 800.226.8201 Boat Builders & Accessory Manufacturers
Call 800.653.8568 Aftermarket Distributors
TACOMarine.com

FEATURE PRODUCT

Neptune T-top



- › Assembles and installs without costly welding
- › Innovative clamp design, assembles without drilling
- › Rugged, marine tested for durability
- › Adjusts to fit most consoles up to 41" W
- › Accessory-Ready™ allows for versatile interchangeable accessorizing and adjustment
- › Outrigger-Ready™ offers quick installation of TACO Grand Slam 270 Outrigger Mounts
- › Packs flat for easy shipping and storage

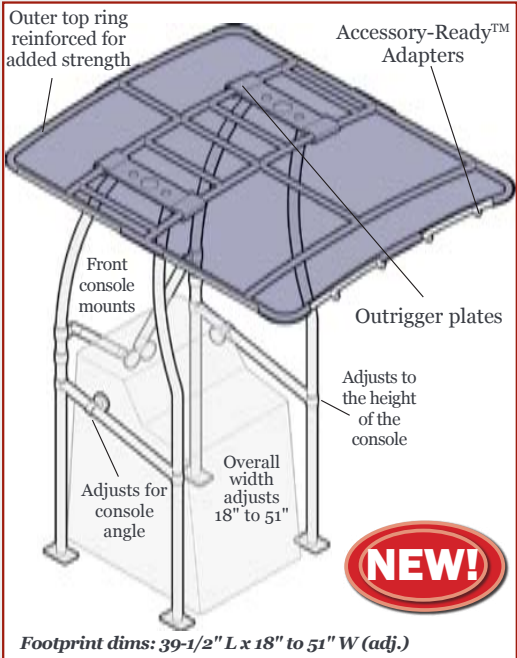
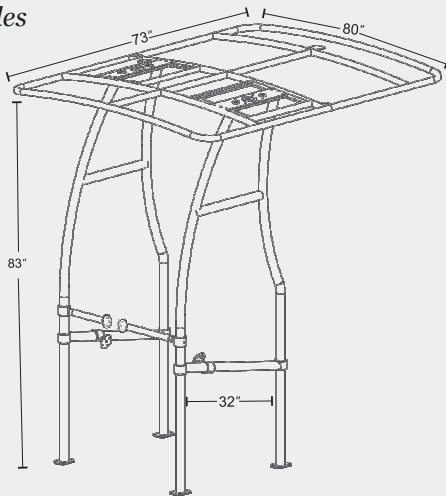

Footprint dims: 39-1/2" L x 18" to 51" W (adj.)

Neptune T-top

- Anodized aluminum • Brushed finish • Outrigger-Ready plates • UV-resistant removable canvas available in choice of colors • Accessory-Ready outer ring
- Assembles without welding or drilling

Bulk/Retail	Description
T34-1000BSA-1	Anodized Aluminum Adjustable T-top
T34-1001BSA-1	Neptune T-top w/Blue Canvas Top
T34-1002BSA-1	Neptune T-top w/Black Canvas Top
T34-1003BSA-1	Neptune T-top w/White Canvas Top

Accessorize with Accessory-Ready Rod Holders, page MF54 and LED Lighting, page MA91



T34-1002BSA-1

Marine Fabrication

Accessories

Bulk/Retail	Description
T30-0001BLU-1	Blue Canvas
T30-0001BLK-1	Black Canvas
T30-0001WHA-1	White Canvas
T36-1050BSA-1	Brushed Aluminum Grab Rail fits 3/4" & 1" I.P.S. Pipe

T36-1050BSA-1



Please refer to page REF100-101 for conversion, color and finish information

Call 800.226.8201 Boat Builders & Accessory Manufacturers
Call 800.653.8568 Aftermarket Distributors
TACOMarine.com





Leaning Posts *Neptune* By TACO



- Sturdy, anodized aluminum frame
- Optional accessory upgrades
- Cool white cushioned upholstery
- Bolt-down installation
- Individually boxed and labeled for readily identifiable product content and attractive retail merchandising

FEATURE PRODUCT

Neptune III Leaning Post



TACO's patent-pending Accessory-Ready™ spline technology offers easy installations and adjustments of rod holders and other accessories. Optional clamp-on grab rail and backrest w/grab rail available.

Footprint dims: 15-3/8" x 35-3/16"



Neptune III

- Features TACO's patent-pending Accessory-Ready™ adapters
- Easy installation and adjustment of rod holders and accessories
- Small footprint, great for smaller boats
- Anodized aluminum with brushed finish for durability

Bulk/Retail	Description	Dimensions
L10-2000BSA-1	Neptune III Leaning Post w/Accessory-Ready Adapters	33"H x 35-3/16"L x 15-3/8"W

Accessorize with Accessory-Ready Rod Holders, page MF54 and Poly Accessories, page MA96

Accessories

- Clamp-on for accessories for easy addition & removal
- Ergonomic backrest designed for comfort
- Easy reach grab rail



Bulk/Retail	Description	Dimensions
L11-2600BSA-1	Clamp-On Grab Rail & Backrest	20"H x 32"L x 12"W
L11-3000BSA-1	Clamp-On Grab Rail	32-1/2" Center-to-Center

Please refer to page REF100-101 for conversion, color and finish information



Call 800.226.8201 Boat Builders & Accessory Manufacturers
Call 800.653.8568 Aftermarket Distributors
TACOMarine.com

Neptune Premium

- Constructed of polished, anodized aluminum and fiberglass • 4 integrated rod holders
- Spacious fiberglass storage under cushion • Optional backrest

Bulk/Retail	Description	Dimensions
L10-1001-1	Neptune Premium Leaning Post w/Fiberglass Storage	31-1/2"H x 27"L x 39"W



L10-1001

Neptune II

- Designed for center consoles • Unique, easy-to-remove soft storage converts to tote for gear
- Constructed of polished anodized aluminum
- 4-Rod holder rack • Small footprint ideal for small to medium-sized boats

Bulk/Retail	Description	Dimensions
L10-1003-1	Neptune II Leaning Post w/Removable Soft Storage	33"H x 22"L x 35"W



Patent #7,819,483

L10-1003

Universal Leaning Post Backrest

- Universal design to fit Neptune Leaning Posts and most standard leaning posts • Arms install at desired width to fit rod holders
- Cool, white, easy-to-clean, cushioned backrest • Arms fold for easy storage when not in use

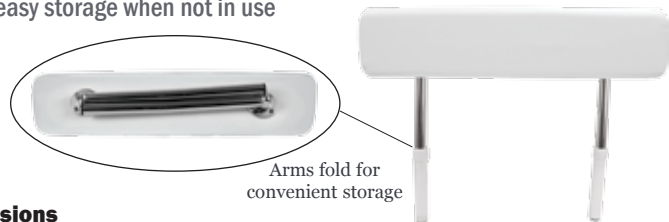

Bulk/Retail	Description	Dimensions
L10-1002-1	Leaning Post Backrest w/Folding Arms	7-3/8"H x 33-5/8"L x 3"W

L10-1002

Leaning Post Components

Leaning Post Backrest Arms

- Ergonomic design, bent for seating comfort • 1" I.P.S. pipe • Anodized aluminum • Polished finish • Sold in pairs

Bulk	Description	Length
F34-0005BXA	1" I.P.S. Aluminum Arms for Leaning Post Backrest	20-3/4"



F34-0005

Footrest Hinge

- For use on leaning posts • Designed for 1" I.P.S. pipe
- Anodized aluminum • Polished finish

Bulk	Description	Dimensions
F34-0002BXY	Recessed Hinge	1-9/16"D x 2-7/8"H x 2"W

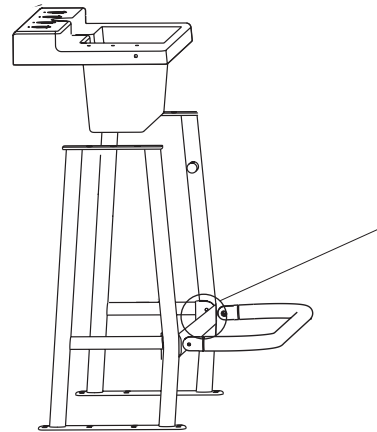

F34-0002

Pins & Pads



F30-0021



F30-1940



F35-FRB

Bulk	Description	Length	Width	Hole	I.P.S.	Finish
F30-0021BLY	Female Ear & Pin w/Washers	1"	3/8"	3/8"	1"	Brite Anodized
F30-1940BSY	Pads Ear Mount	2"	2-1/2"	3/8"	-	180 Grit Anodized
F35-FRB	Folding Footrest Pad - 5/16" Thick	2"	2-1/2"	5/16"	-	180 Grit Anodized

Cooler Strap

Bulk	Description	Dimensions
L10-1004	Black Nylon Cooler Strap & Stainless Steel Brackets	2"W x 38"L



L10-1004

Please refer to page REF100-101 for conversion, color and finish information



Call 800.226.8201 Boat Builders & Accessory Manufacturers
 Call 800.653.8568 Aftermarket Distributors
TACOMarine.com



Bimini & Canvas Tops

- Polished stainless steel tube
- Assortment of high-quality fittings and accessories

Stainless Steel Type 304

- Ideally suited for bow and grab rails, canvas top frames
- Offered in a variety of sizes and wall thickness to suit wide range of applications
- Polished finish
- Also offered in stainless steel type 316

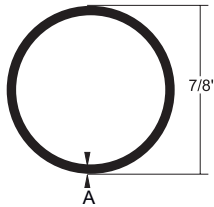

S14-7849 • S14-7865

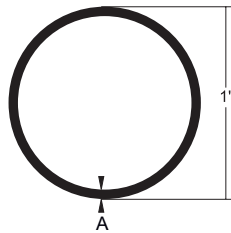

S14-1049 • S14-1065

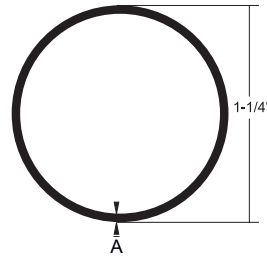

S14-1465

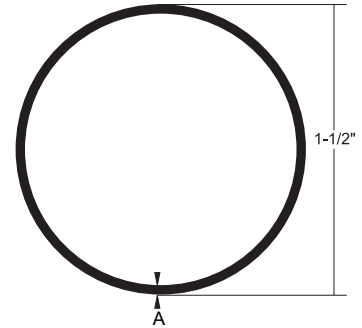

S14-1265

Bulk	Retail	Outside Dia.	"A"	Length
S14-1049P12	S14-1049P12-1	1"	.049"	12'
S14-1049P20	S14-1049P20-1	1"	.049"	20'
S14-1049P20B*	-	1"	.049"	20'
S14-1049P24	-	1"	.049"	24'
-	S14-1049P6-1	1"	.049"	6'
S14-1065P20	S14-1065P20-1	1"	.065"	20'
S14-1065P24	-	1"	.065"	24'
S14-1065P24B*	-	1"	.065"	24'
S14-1465P20	-	1-1/4"	.065"	20'
S14-1465P24	-	1-1/4"	.065"	24'
S14-1465P24B*	-	1-1/4"	.065"	24'
S14-1265P20	-	1-1/2"	.065"	20'
S14-7849P12	S14-7849P12-1	7/8"	.049"	12'
S14-7849P20	S14-7849P20-1	7/8"	.049"	20'
S14-7849P24	-	7/8"	.049"	24'
-	S14-7849P6-1	7/8"	.049"	6'
S14-7865P20	S14-7865P20-1	7/8"	.065"	20'
S14-7865P24	-	7/8"	.065"	24'
S14-7865P24B*	-	7/8"	.065"	24'

*Stainless steel type 316

Please refer to page REF100-101 for conversion, color and finish information

Call 800.226.8201 Boat Builders & Accessory Manufacturers
Call 800.653.8568 Aftermarket Distributors
TACOMarine.com



FEATURE PRODUCT

Ball & Socket Top Fittings

- › Patented ball & socket pivot design offers full rotation
- › Delrin insert provides tight, rattle-free fit
- › Easy, one-person installation
- › Upgrade without repatterning
- › Fits existing side curtains, canvas and tube
- › Deck hinges fit 7/8", 1" tube and windshield headers
- › Quick release pull and D-ring pin
- › Corrosion resistant stainless steel type 316
- › Attractive, polished finish

Patent #D437,210; #D451,364; #D451,371

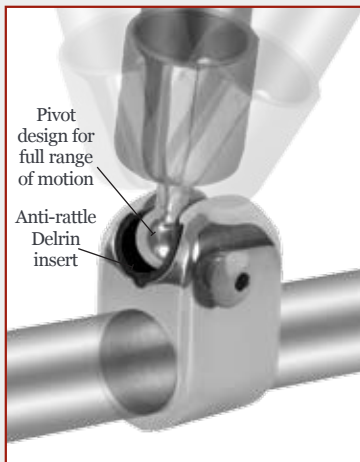

Top Hardware - Stainless Steel Type 316

Ball & Socket Top Fittings

Top Caps

- Offered for 3/4", 7/8" & 1" tube • Available with pop-riquet and set screw • Polished finish



F11-0171A



F11-0180S



F11-0182

Bulk	Retail*	Description	Tube Size	Fastener
F11-0171A	-	Inside Top Cap	7/8"	Pop Rivet
F11-0177A	-	Top Cap	7/8"	Pop Rivet
F11-0177S	F11-0177A-1	Top Cap	7/8"	Set Screw
F11-0180P	-	90° Top Cap for Portside (Side Mount)	7/8"	Pop Rivet
F11-0180S	-	90° Top Cap (Side Mount)	7/8"	Set Screw
F11-0180SB	-	90° Top Cap for Starboard (Side Mount)	7/8"	Pop Rivet
F11-0182	-	Top Cap	3/4"	Pop Rivet
F12-0181	-	Top Cap	1"	Pop Rivet

*Blister pack (each)

Jaw Slides

- Delrin insert for a rattle-free and smooth operation • Offered for 7/8" & 1" tube

Bulk	Retail*	Tube Size	Fastener
F11-1001AS	F11-1001-1	7/8"	Set Screw
F11-1001	-	7/8"	Pop Rivet
F12-0300	-	1"	Pop Rivet
F12-0300S	F12-0300-1	1"	Set Screw

*Blister pack (each)



F12-0300S

Please refer to page REF100-101 for conversion, color and finish information



Call 800.226.8201 Boat Builders & Accessory Manufacturers
 Call 800.653.8568 Aftermarket Distributors
TACOMarine.com

Deck Hinges

- Offered in concave and flat mounts • Secure fit with removable pin and lanyard or turn and lock D-ring



Bulk	Retail*	Description	Tube Size	Fastener
F13-0241/244BN	F13-0241/244BN-1	Flat Deck Hinge w/Pin & Lanyard	7/8"	-
F13-0242/244BN	-	Concave Deck Hinge w/Pin & Lanyard	7/8"	-
F13-0301/244BN	-	Deck Hinge w/Pin & Lanyard	-	-
F13-0302/244BN	F13-0302/244BN-1	Concave Deck Hinge w/Pin & Lanyard	1"	-
F13-1085P	-	Deck Hinge w/D-Ring, Port	-	-
F13-1085S	-	Deck Hinge w/D-Ring, Starboard	-	-
F13-1095P	-	Concave Deck Hinge w/D-Ring, Port	7/8" & 1"	-
F13-1095S	-	Concave Deck Hinge, Starboard	7/8" & 1"	-
Deck Hinge Accessory				
F13-0244BN	-	Stainless Steel Pin & Lanyard w/Plastic Knob	-	-

*Blister pack (each)

Accessory



F13-0244

Top Hardware

Inside Eye Ends

- Available in deluxe polished stainless steel type 316 and black nylon

Outside Eye Ends

- Available in deluxe polished stainless steel type 316 and black nylon

Bulk	Retail*	Tube	Bolt	Style
Inside Eye Ends				
F11-0172	-	7/8" x .058"	1/4"	-
F11-0174	-	7/8" x .049"	1/4"	-
F40-0278BN	-	7/8" x .058"	1/4"	-
Outside Eye Ends				
F11-0100	F11-0100-1	7/8"	1/4"	With Set Screw
F11-0107N	-	3/4"	1/4"	Without Set Screw
F12-0101	F12-0101-1	1"	1/4"	With Set Screw
F17-0106▼	-	1-1/4"	1/4"	With 2 Set Screw
F40-0718BN	-	7/8"	1/4"	-

▼Heavy-duty *Blister pack (each)



Marine Fabrication

Jaw Slides

- Available in deluxe polished stainless steel type 316 and black nylon

Bulk	Retail*	Tube	Bolt	Style
F11-0160	F11-0160-1	7/8"	1/4"	-
F11-0163	-	7/8"	1/4"	Stamped
F11-1000	F11-1000-1	7/8"	1/4"	Clamp-on
F12-0161	F12-0161-1	1"	1/4"	-
F12-1001	F12-1001-1	1"	1/4"	Clamp-on
F17-0166▼	-	1-1/4"	1/4"	Set Screw
F40-0878BN	-	7/8"	10-24	Set Screw

▼Heavy-duty *Blister pack (each)



Please refer to page REF100-101 for conversion, color and finish information

Call 800.226.8201 Boat Builders & Accessory Manufacturers
Call 800.653.8568 Aftermarket Distributors
TACOMarine.com



Deck Hinges

• Available in deluxe polished stainless steel type 316 and black nylon • #10 fasteners



F13-0200 • F13-0220



F13-0210



F13-0230 • F13-0235



F13-0240 • F13-0246



F13-0250



F40-0504

Bulk	Retail*	Description	Bolt	Width	Length
F13-0200	F13-0200-1	Standard 90° Base w/Bolt	1/4"- 20	11/16"	2"
F13-0210	F13-0210-1	90° Base w/1/4" Toggle Pin	-	11/16"	2"
F13-0220	-	Standard 90° Base w/o Bolt	-	11/16"	2"
F13-0230	F13-0230-1	80° Angle Base w/Bolt	1/4"- 20	7/8"	2"
F13-0235	-	80° Angle Base w/Bolt	-	7/8"	2"
F13-0240	F13-0240-1	Concave Base w/Bolt	1/4"- 20	7/8"	2"
F13-0246	-	Concave Base w/Bolt	-	11/16"	2"
F13-0250	F13-0250-1	Small 2-Hole Side Mount w/Bolt	1/4"- 20	1-7/8"	2"
F40-0504BN	-	Standard 90° Deck Hinge Base	10-24	13/16"	2-3/8"

*Blister pack (each)

Accessories

• Available in stainless steel type 304 and black nylon • #10 fasteners • Sold in pairs



F13-0102

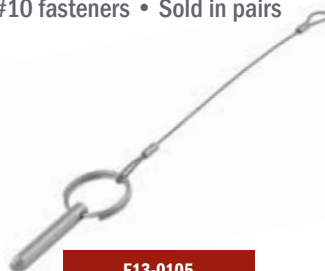

F13-0105



F13-0107

Bulk	Retail*	Description	Pin Grip	Pin Dia.	Opening	Color	Finish
Pins & Lanyards							
F13-0102T	-	6" Lanyard w/Ring	-	-	-	-	-
F13-0105	F13-0105-1	Pin w/6" Lanyard	1"	1/4"	-	-	-
F13-0107T	F16-0107T-1	Toggle Pin w/6" Lanyard & Tab	1"	1/4"	-	-	-



F16-1200 • F16-1210

Eye Straps							
F16-1200	F16-1200-1	Stamped Eye Strap	-	-	3/16"	-	Polished
F16-1210	-	Stamped Eye Strap	-	-	5/16"	-	Polished
F40-0704BN	-	Nylon Eye Strap	-	-	3/16"	Black	-



F40-0704

*Blister pack (each)

Curtain Track & Components

Aluminum & Nylon

• Ideal for curtains in cutty, cabins and yachts

Bulk	Height	Width	Length	Style	Color	Finish
A52-0051VEL12	5/16"	11/16"	12'	Track	-	Satin Anodized
F40-0112	-	-	-	Sew-On Carrier	White	-
F40-0119	-	-	-	End Cap	White	-



A52-0051



F40-0112



F40-0119

Please refer to page REF100-101 for conversion, color and finish information



Call 800.226.8201 Boat Builders & Accessory Manufacturers
 Call 800.653.8568 Aftermarket Distributors
TACOMarine.com

Canvas Top Accessories

Telescoping Boat Cover Pole

- Anodized aluminum and nylon
- Available in two telescoping lengths
- Cam lever secures adjustable height position

Telescoping boat cover pole extends between the boat deck and underside of cover to pitch the cover and prevent sagging. Staining and damage from debris and water pooling is eliminated extending the boat cover's life and beauty.

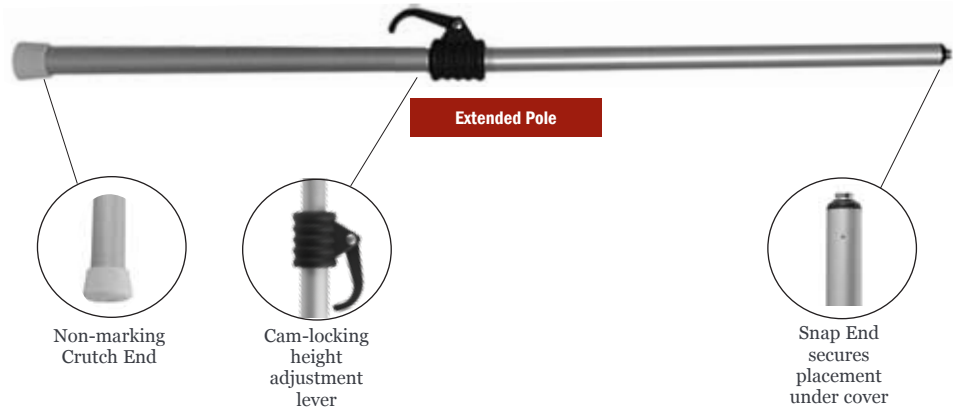

Bulk	Description	Telescoping Range	Color	Finish
T10-7579VEL2	Support Pole w/Snap-On End	24" - 45.5"	Black	Satin
T10-7579VEL2.5	Support Pole w/Snap-On End	30" - 57.5"	Black	Satin

Canvas & Upholstery Welting & Track

Vinyl & Aluminum

- For use on canvas tops, bolsters and other accessories

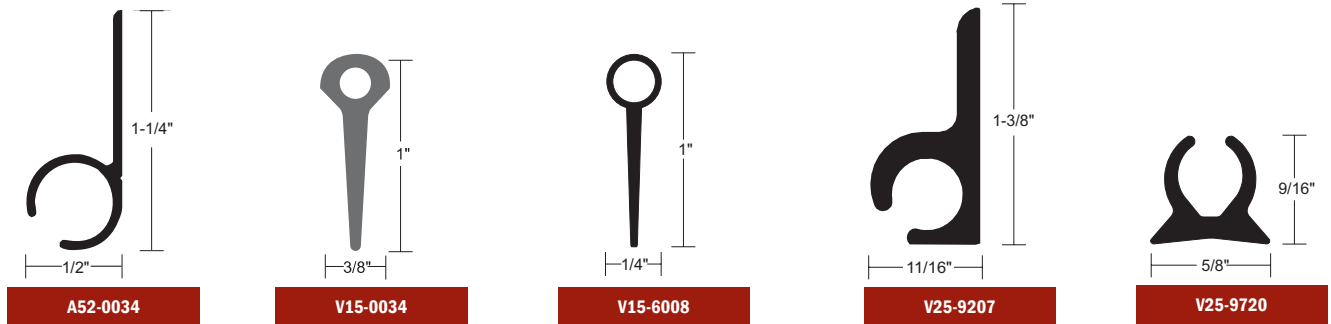

Bulk	Height	Width	Length	Color	Style	Finish
A52-0034BLY16	1-1/4"	1/2"	16'	-	Aluminum	Brite Anodized
V15-0034WHA250A	1"	3/8"	250'	Brite White	Rigid	-
V15-6008GRA500	1"	3/8"	500'	Medium Gray	Rigid	-
V25-9207WHA20	1-3/8"	11-1/16"	20'	Brite White	Rigid	-
V25-9720WHC20	9/16"	5/8"	20'	White	Flexible	-

Slide Track

Bulk	Height	Width	Opening	Length	Finish
A52-0037BLY14	7/16"	7/8"	3/8"	14'	Brite Anodized

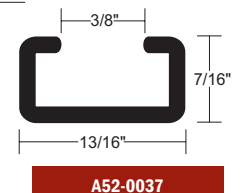

Please refer to page REF100-101 for conversion, color and finish information

Call 800.226.8201 Boat Builders & Accessory Manufacturers
Call 800.653.8568 Aftermarket Distributors
TACOMarine.com





Railing

- Hand rail fittings
- Elliptical tube features sleek profile styling and polished mirror finish

Tube - Stainless Steel Type 316

Elliptical

• Stylish, elliptical tube with 0.060" wall thickness and polished mirror finish • Great for exteriors and interiors • Ideal for bow rails, radar arches, grab rails, spiral staircase railing and marine furniture



S17-0905

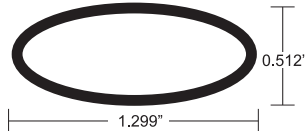

S17-1305

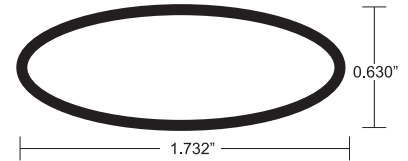

S17-1706

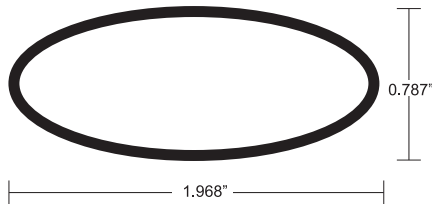

S17-2078

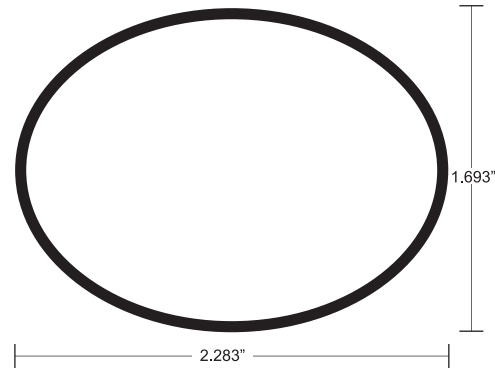

S17-2317

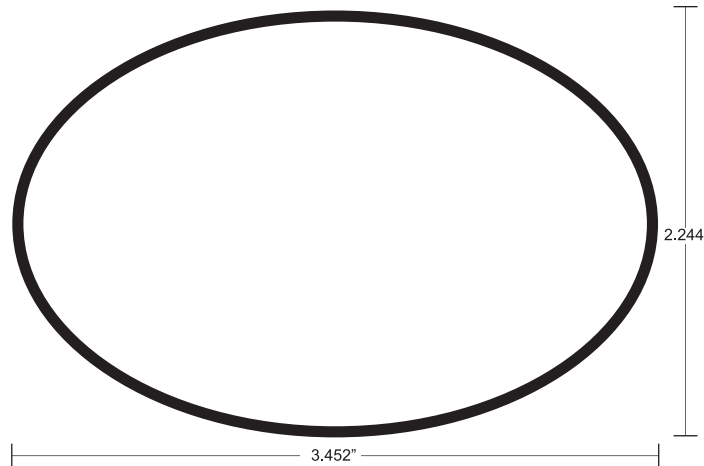

S17-3442

Bulk	Width	Height	Length
S17-0905PM20B	0.905" (23.0mm)	0.500" (12.7mm)	20'
S17-1305PM20B	1.299" (33.0mm)	0.512" (13.0mm)	20'
S17-1706PM20B	1.732" (44.0mm)	0.630" (16.0mm)	20'
S17-2078PM20B	1.968" (50.0mm)	0.787" (20.0mm)	20'
S17-2317PM20B	2.283" (58.0mm)	1.693" (43.0mm)	20'
S17-3442PM20B	3.452" (87.0mm)	2.244" (57.0mm)	20'

Please refer to page REF100-101 for conversion, color and finish information



Call 800.226.8201 Boat Builders & Accessory Manufacturers
Call 800.653.8568 Aftermarket Distributors
TACOMarine.com

Hand Rail & Fittings

Rectangular Bases – Cast Stainless Steel Type 316

- Deluxe polished • Uses #10 oval head mounting screws

Bulk	Retail*	Tube	Base Size	Overall Height	Style
F14-0079	F14-0079-1	7/8"	1-9/16" x 1-3/16"	1-15/16"	Center 60°
F14-0081	F14-0081-1	7/8"	1-9/16" x 1-3/16"	1-15/16"	Aft 60°
F15-0179	F15-0179-1	1"	1-11/16" x 1-1/4"	2-1/4"	Center 60°
F15-0180	F15-0180-1	1"	1-11/16" x 1-1/4"	2-1/4"	Forward 120°
F15-0181	F15-0181-1	1"	1-11/16" x 1-1/4"	2-1/4"	Aft 60°

*Blister pack (each)



Aft 60°



Center 60°



Forward 120°

Rectangular Bases – Die Cast Zamak

- Chrome plated

Bulk	Tube	Base Size	Overall Height	Style
F80-0080	7/8"	1-9/16" x 1-3/16"	1-15/16"	Forward 120°
F80-0079	7/8"	1-9/16" x 1-3/16"	2-3/16"	Center 60°
F80-0079A	7/8"	-	2-9/16"	Center 60° Large
F80-0081	7/8"	1-9/16" x 1-3/16"	2-3/16"	60° Aft Small
F80-0081A	7/8"	-	2-5/8"	60° Aft Large

Rail Fittings

Cast Stainless Steel Type 316

- Deluxe polished

Bulk	Retail*	Tube	Base Size	Bolt	Style
Rectangular Bases					
F14-0041	F14-0041-1	7/8"	3" x 1-3/4"	#10	90°
F14-0042	F14-0042-1	7/8"	3" x 1-3/4"	#10	60°
F15-0115	F15-0115-1	1"	3-1/4" x 1-7/8"	1/4"	45°
F15-0141	F15-0141-1	1"	3-1/4" x 1-7/8"	1/4"	90°
F15-0142	F15-0142-1	1"	3-1/4" x 1-7/8"	1/4"	60°
Round Bases					
F14-0039	F14-0039-1	7/8"	2-5/8"	#10	90°
F14-0040	F14-0040-1	7/8"	2-5/8"	#10	60°
F15-0114	F15-0114-1	1"	2-7/8"	1/4"	45°
F15-0139	F15-0139-1	1"	2-3/4"	1/4"	90°
F15-0140	F15-0140-1	1"	2-5/8"	1/4"	60°
Universal Tees					
F14-0043	F14-0043-1	7/8"	-	-	90°
F14-0093	F14-0093-1	7/8"	-	-	60°
F15-0143	F15-0143-1	1"	-	-	90°
F15-0193	F15-0193-1	1"	-	-	60°
Elbows					
F14-0046	F14-0046-1	7/8"	-	-	90° - 3 Way
F14-0076	F14-0076-1	7/8"	-	-	90° - 2 Way
F15-0176	F15-0176-1	1"	-	-	90° - 2 Way
Bow Form					
F14-0051	F14-0051-1	7/8"	-	-	110°

*Blister pack (each)



Rectangle
90° • 60° • 45°



Round
90° • 60° • 45°



Elbows
90° - 2 Way • 90° - 3 Way



Bow Form



Universal Tees
60° • 90°

Die Cast Zamak

- Chrome plated

Bulk	Tube	Base Size	Bolt	Style
Rectangular Bases				
F80-0041	7/8"	3" x 1-3/4"	1/4"	90°
Round Bases				
F80-0039	7/8"	2-5/8"	#10	90°
F80-0040	7/8"	2-5/8"	#10	60°
Universal Tees				
F80-0043	7/8"	-	-	90°
Elbows				
F80-0076	7/8"	-	-	90° - 2 Way

Marine Fabrication

Please refer to page REF100-101 for conversion, color and finish information

Call 800.226.8201 Boat Builders & Accessory Manufacturers
Call 800.653.8568 Aftermarket Distributors
TACOMarine.com



TACO Metals sport fishing

products lead the way in innovation, quality and performance. TACO's highly qualified engineering staff and fishing enthusiasts work together to develop industry-leading products. All products are tested to ensure they meet TACO's high standards and are backed by an industry-best 3-year warranty.

TACO Sport Fishing products include:

OUTRIGGER MOUNTS

- » A full line of outrigger mounts for tops and gunnels
- » Well-known in the industry, TACO Grand Slam series outrigger mounts are the leaders in performance and reliability

TELE-OUTRIGGERS™

- » Anodized aluminum with stainless steel type 316 spring buttons and eyelets offer superior strength, durability and smooth operation
- » Offered in a variety of sizes and colors

ROD HOLDERS

- » TACO offers an extensive array, from clamp-on to surface mount. TACO rod holders are offered in a variety of sizes, materials, colors and finishes
- » Available in stainless steel type 316, anodized aluminum, glass-reinforced nylon and UV-stabilized polyethylene

ROD STORAGE

- » Wide variety for use on boats of all sizes and types - fishing, cruising, sport, and pleasure
- » Products designed for transoms, consoles, gunnels and fly-bridges
- » Available in stainless steel type 316, anodized aluminum and UV-stabilized polyethylene

69	Grand Slam 370 Mounts
70	Grand Slam 270 Mounts & Kits
71	Sport Slam Mounts & Kits
71	Striker Bases & Kits
72	Center Riggers
73	Tele-Outriggers & Accessories
74	Rigging Kits & Accessories
75	Mounting & Backing Plates
76	Rod Holders
78	Rod Storage



Outrigger Mounts

- Adjustable fishing positions
- Designed and manufactured for ease of use, reliability and durability
- Top mount and gunnel mount options



Rub Rail | Trim & Moulding | Hinges & Latches | Marine Fabrication | Sport Fishing | Pedestal Systems | Marine Accessories

FEATURE PRODUCT

Grand Slam 370

- › Fully adjustable from under the top for safe operation
- › Versatile design for use on soft tops and hard tops up to 2" thick
- › Rugged, rotator handle pulls-down and locks-in 12 fishing positions
- › Offset 30° rotator handle offers added hand clearance
- › Crank handle adjusts trolling height and folds up for added under top clearance
- › Lay down arm position for safe navigation under bridges, trailering and storage
- › Bolt-down installation in minutes with Outrigger-Ready plates
- › Installs in minutes with Outrigger-Ready plates
- › Ideally suited for 35' - 45' center console and express boats



Fully Adjustable from Under Top

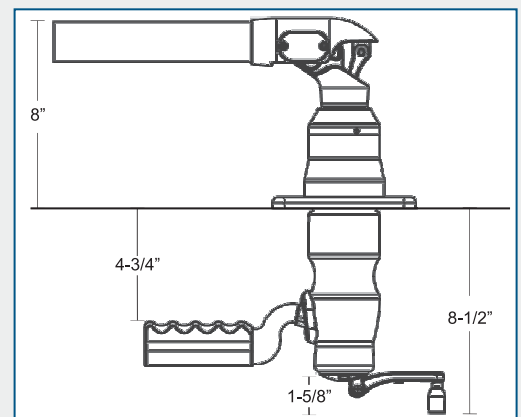
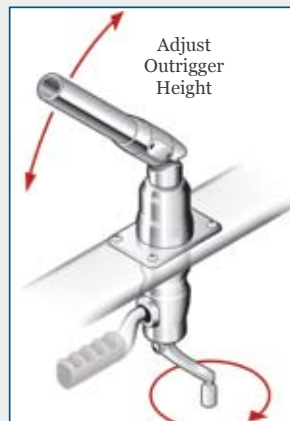
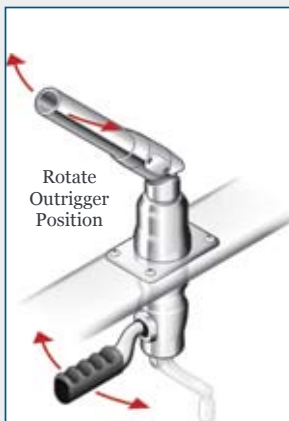

Grand Slam 370 Outrigger Mount

- Top mount • Brushed anodized aluminum body • Polished stainless type 316 steel arm • Accepts 1-1/2" butt end diameter, heavy-duty outriggers • 4" x 6" mounting base • Sold in pairs

Bulk/Retail	Description
GS-370	Grand Slam 370 Outrigger Mount

Please refer to page REF100-101 for conversion, color and finish information

Call 800.226.8201 Boat Builders & Accessory Manufacturers
Call 800.653.8568 Aftermarket Distributors
TACOMarine.com



SF69

FEATURE PRODUCT

Grand Slam 270 Series

- › Under-top rotator handle installs at desired angle to avoid obstruction with top
- › Rugged, rotator handle pulls-down and locks-in 12 fishing positions for safe operation from under the top
- › Ergonomic knob locks-in outrigger trolling height position
- › Lay down arm position for safe bridge navigation, trailer and storage
- › Ideally suited for 25' - 45' center console and express boats

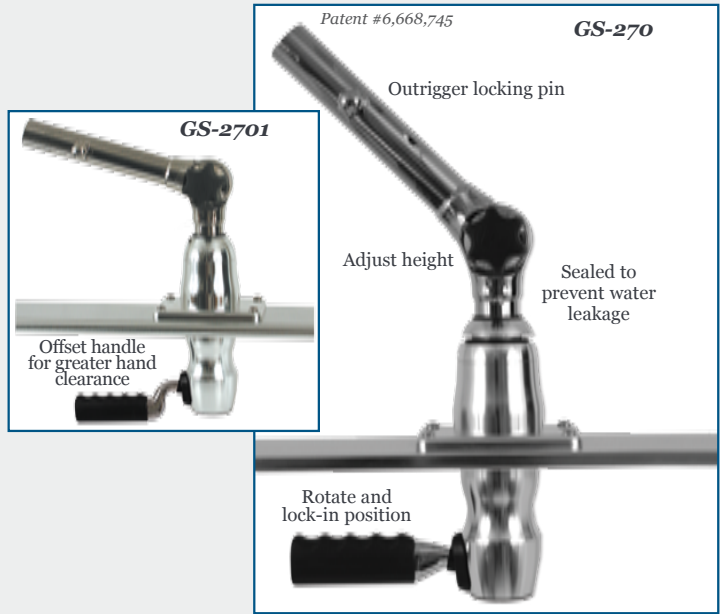
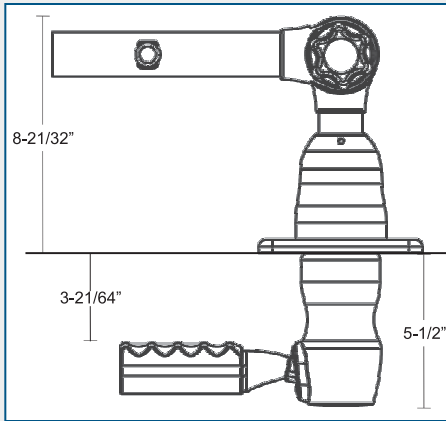

Variable Rotator Handle Installation Positioning

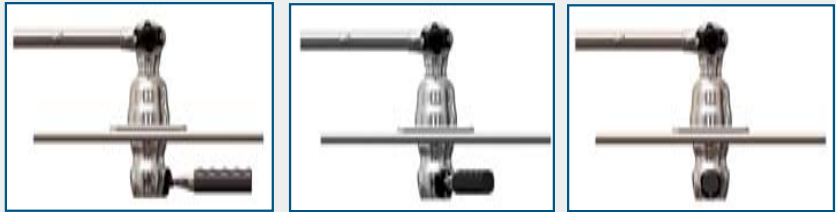

Grand Slam 270 Series Outrigger Mounts

- Brushed anodized aluminum body • Polished stainless steel type 316 arm • Accepts 1-1/2" butt end diameter, heavy-duty outriggers
- 4" x 6" mounting base • Offered with standard or 30° offset handle • Sold in pairs

Bulk/Retail	Description
GS-270	Grand Slam 270 Outrigger Mount
GS-2701	Grand Slam 270 w/30° Offset Handle

Grand Slam 270 Kits

- Include mounts, 15' outriggers, rigging kits and line caddy



Tele-Outriggers



Premium Rigging Kit



Line Caddy

Retail	Mount	Outriggers	Accessories
GS-2741BKA-1	Grand Slam 270	1-1/2" Black/Gold 15' Outriggers	Premium Rigging Kit & Line Caddy
GS-2741VEL-1	Grand Slam 270	1-1/2" Silver/Gold 15' Outriggers	Premium Rigging Kit & Line Caddy
GS-2742VEL-1	Grand Slam 270	1-1/2" Silver/Silver 15' Outriggers	Premium Rigging Kit & Line Caddy

Please refer to page REF100-101 for conversion, color and finish information



Call 800.226.8201 Boat Builders & Accessory Manufacturers
 Call 800.653.8568 Aftermarket Distributors
TACOMarine.com

Sport Slam

100 Series Outrigger Mounts

- Stainless steel type 316 • Mounting plate size 4" x 6"
- For use with 1-1/8" butt end diameter outriggers • Sold in pairs

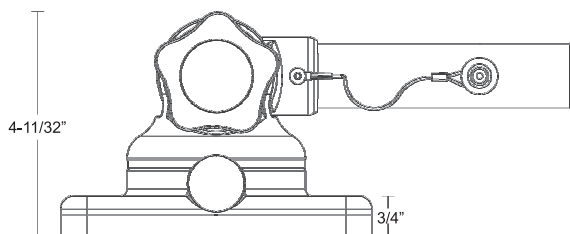

Bulk/Retail	Description
GS-100A	Sport Slam Mount

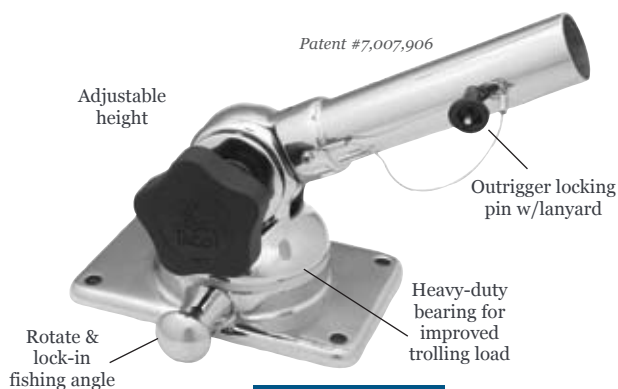

GS-100A

Sport Slam Kits

- Include mounts, 15' outriggers, rigging kits and line caddy



Tele-Outriggers



Standard Rigging Kit



Line Caddy

Retail	Mount	Outriggers	Accessories
GS-100ABKA15	Sport Slam	1-1/8" Black/Gold 15' Outriggers	Standard Rigging Kit & Line Caddy
GS-100AVEL15	Sport Slam	1-1/8" Silver/Gold 15' Outriggers	Standard Rigging Kit & Line Caddy

Striker Base

Stainless Steel Type 316

- Unique Hex nut locking design offers multiple fishing positions • Ambidextrous 45° arms ideal for trolling from gunnel
- Removable arms allow for unobstructed deck • Polished finish • Mounts sold in pairs • Replacement arms sold as each

Bulk/Retail	Description	Outrigger Dia.
F16-0150-F	Gunnel mount 6"L x 4"W Base w/45° Arm	1-1/2" Butt End
F16-0212-F	Gunnel mount 5-1/8"L x 2-5/8"W Base w/45° Arm	1-1/8" Butt End
M17-1465P-4-1	Replacement 45° Arm for F16-0212-F Base	1-1/8" Butt End
M17-1565P-6	Replacement 45° Arm for F16-0150-F Base	1-1/2" Butt End

Striker Base Kits

- All inclusive kits include mounts, outriggers and accessories



Tele-Outrigger



Standard Rigging Kit



Line Caddy



Retail	Mount	Outriggers	Accessories
F16-441BKA15SB1	Striker Base	1-1/8" Black/Gold 15' Outriggers	Standard Rigging Kit & Line Caddy

Please refer to page REF100-101 for conversion, color and finish information

Call 800.226.8201 Boat Builders & Accessory Manufacturers
Call 800.653.8568 Aftermarket Distributors
TACOMarine.com





Center Riggers

- For added fishing lines
- Top mount & clamp-on options

Sport Slam Center Rigger

Stainless Steel Type 316

- Top mount • 4" x 6" Mounting plate • For use with 8' center riggers with 1-1/8" butt end diameter
- Polished finish • Sold as each

Retail	Description
GS-100A-2	Sport Slam Center Rigger



F16-0311C-1

Clamp-On Center Rigger

Stainless Steel Type 316

- Clamp-on installation • Fits 3/4" & 1" I.P.S. pipe • Anti-rotation set screw • For use with 8' center riggers with 1-1/8" butt end diameter • Polished finish • Sold as each

Retail	Description
F16-0311C-1	Clamp-On Center Rigger



F16-0311C-1

Clamp-On Center Rigger Kit

- All inclusive kit includes clamp-on center rigger, outrigger and rigging kit • Sold as each



Tele-Outriggers



Center Rigging Kit

Retail	Mount	Outriggers	Accessories
F16-0311BKA8SB	Clamp-On Center Rigger	1-1/8" Black/Gold 8' Center Rigger	Center Rigging Kit
F16-0311VEL8SB	Clamp-On Center Rigger	1-1/8" Silver/Gold 8' Center Rigger	Center Rigging Kit

Please refer to page REF100-101 for conversion, color and finish information



Call 800.226.8201 Boat Builders & Accessory Manufacturers
 Call 800.653.8568 Aftermarket Distributors
TACOMarine.com



Outriggers & Accessories

- Anodized aluminum outrigger poles, rings and tips
- High performance 316 stainless springs, button and eyelets
- Variety of sizes and colors

Tele-Outriggers

1-1/8" or 1-1/2" Butt End Diameter

- Telescopes to less than 6' for bridge clearance, trailering and storage
- Designed for universal use with Grand Slams, Sport Slams, Striker Bases and other brands of mounts that accept 1-1/2" or 1-1/8" butt end diameter outriggers
- Sold in pairs

Bulk/Retail	Length	Butt End Dia.	Color	Finish
OT-0441BKA15	15'	1-1/8"	Black w/Gold Rings & Tips	Satin/Polished
OT-0441VEL15	15'	1-1/8"	Silver w/Gold Rings & Tips	Satin/Polished
OT-0541BKA15-HD	15'	1-1/2"	Black w/Gold Rings & Tips	Satin/Polished
OT-0541VEL15-HD	15'	1-1/2"	Silver w/Gold Rings & Tips	Satin/Polished
OT-0542BKA15-HD	15'	1-1/2"	Black w/Silver Rings & Tips	Satin/Polished
OT-0542VEL15-HD	15'	1-1/2"	Silver w/Silver Rings & Tips	Satin/Polished
OT-0551BKA186	18'	1-1/2"	Black w/Gold Rings & Tips	Satin/Polished
OT-0551VEL186	18'	1-1/2"	Silver w/Gold Rings & Tips	Satin/Polished
OT-0552VEL186	18'	1-1/2"	Silver w/Silver Rings & Tips	Satin/Polished

Patent #5,921,196



Tele-Outriggers

Center Riggers

- Telescopes to less than 5'-6"
- Designed for universal use with TACO Center Riggers and other brands that accept 1-1/8" butt end diameter center riggers
- Anodized aluminum
- Sold as each

Bulk/Retail	Length	Butt End Dia.	Color	Finish
OC-0421BKA8	8'	1-1/8"	Black w/Gold Rings & Tips	Satin/Polished
OC-0421VEL8	8'	1-1/8"	Silver w/Gold Rings & Tips	Satin/Polished
OC-0422VEL8	8'	1-1/8"	Silver w/Silver Rings & Tips	Satin/Polished



Precision Locking Pin

Accessories

Base Reducer

- Aluminum
- Reduces I.D. from 1-1/2" to 1-1/8" to accept 1-1/8" butt end diameter outriggers

Retail*	I.D.	O.D.
GSC-0025-1	1-1/8"	1-1/2"

*Poly bagged (each)



GS-0025

Outrigger Line Caddy

- Clamps to outriggers to eliminate tangling and maintain rigging when outriggers are retracted
- Rugged nylon
- Sold as 2 pair

Retail	I.D.	Color
F40-0030BKA-1	1-1/8" & 1-1/2"	Black

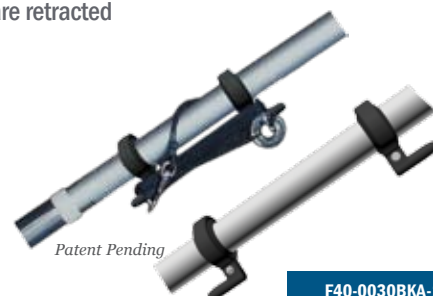

Patent Pending

F40-0030BKA-1

Please refer to page REF100-101 for conversion, color and finish information

Call 800.226.8201 Boat Builders & Accessory Manufacturers
Call 800.653.8568 Aftermarket Distributors
TACOMarine.com





Rigging Kits

- All-inclusive kits
- Available in single and double rigs

Premium Rigging Kits

- Complete rigging kit with stainless steel roller, bungee and storage bag
- Includes release clips
- Rigs up to 22' outriggers
- Sold in pairs

Bulk/Retail	Description	Length	Color
RK-0001PB	Single Rigging Kit	100'	Black
RK-0002PB	Double Rigging Kit	200'	Black



RK-0001PB

Standard Rigging Kits

- Complete rigging kit with glass eye, bungee, release clips and storage bag
- Rigs up to 22' outriggers
- Sold in pairs

Bulk/Retail	Length	Color
RK-0001SB	100'	Black



RK-0001SB

Center Rigging Kits

- Single kit rigs up to 25' center rigger
- Sold as each

Bulk/Retail	Length	Color	Style
RK-0001PCB	50'	Black	Premium



RK-0001PCB

Rigging Accessories

- All quality components to upgrade and repair outrigger rigging

Retail*	Description
COK-0001B-1	Standard Release Clip
COK-0001T-1	Premium Release Clip
COK-0004G-1	Clear Glass Eye
COK-0008B-1	Black Dacron Line 100'
COK-00015-1	Red & White 2" Balsa Wood
COK-00020-1	Shock Cord w/Roller
COK-00022-1	Shock Cord w/Double Roller
COK-00024-1	Black Outrigger Carry Bag 74" x 12"

*Blister pack (each)



COK-0001B-1



COK-0001T-1



COK-0004G-1



COK-0008B-1



COK-00015-1



COK-00020-1



COK-00022-1



COK-00024-1



Mounting Plates

- Easy clamp-on installation
- Fits 1-1/16" and 1-5/16" O.D. pipe and oval pipe
- Available pre-drilled or undrilled

Clamp-On Mounting Plate

Anodized Aluminum

- Easy clamp-on installation • Fits 1-1/16" and 1-5/16" O.D. pipe and oval pipe
- Available pre-drilled and undrilled • Modular design allows plate to be cut-to-size to fit all tops



Retail	Description	Length	Units
GSE-1001-1	Universal Clamp-On Mounting Plate	30"	Each
GSE-1002-1	Grand Slam & Sport Slam Clamp-On Mounting Plate	30"	Pair

Clamp-On Mounting Plates make a boat "Outrigger Ready" in an instant, without welding! TACO offers pre-drilled models for mounting TACO Grand Slams and undrilled for mounting lights, radars and antennas.

TACO's clamp-on plates are designed for 1-1/16" & 1-5/16" O.D. pipe and 1" x 1-1/2" oval pipe, common on most T-top outer rings and arches.

Recessed screw design allows the clamp to capture both the T-top pipe and the special mounting plate.

Clamp Assembly

Makes mounting accessories a snap

Accessories

Backing Plate

- For additional support required when mounting to hard tops and gunnels

Retail*	Length	Width	Thickness	Finish	Style
BP150BSY-320-1	6-1/2"	5"	1/4"	320 Grit Brite Anodized	For Grand Slam

*Clam shell (pair)



BP-150BSY-320-1

Wedge Plate

- Injection molded plastic wedges for use with curved T-tops

Retail*	Length	Width	Style	Color
WP-150WHA-1	6"	4"	7.5°	White
WP-151WHA-1	6"	4"	11°	White

*Clam shell (pair)



Wedge Plates

Sport Fishing

Please refer to page REF100-101 for conversion, color and finish information

Call 800.226.8201 Boat Builders & Accessory Manufacturers
Call 800.653.8568 Aftermarket Distributors
TACOMarine.com





Rod Holders

- Available in a variety of mounting styles, materials, finish and colors
- Flared openings for improved rod handling
- Stainless and aluminum rod holders include fungal-resistant vinyl liner

Clamp-On Adjustable Rod Holders

Stainless Steel Type 316

- Adjustable clamp to fit multiple pipe and tube sizes
- For use on vertical and horizontal pipe/tube
- Rotate and lock in fishing angle • Polished finish



Retail	Pipe/Tube	Rod Holder I.D.
F16-2600POL-1	7/8" & 1" O.D. (Tube)	1-3/4"
F16-2623POL-1	1-1/16" & 1-5/16" O.D. (Pipe), 1-1/4" O.D. (Tube)	1-3/4"
F16-2630POL-1	1-11/16" & 1-15/16" O.D. (Pipe)	1-7/8"

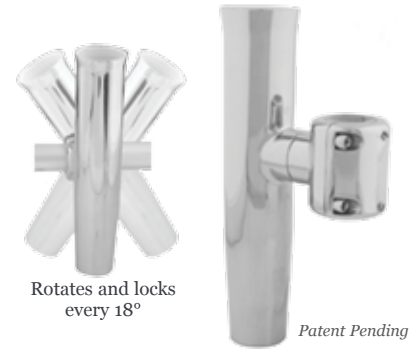

Rotates and locks every 18°

Patent Pending

F16-2623

Anodized Aluminum

- Adjustable clamp to fit two pipe sizes • For use on vertical and horizontal pipe
- Add, remove and angle with standard Allen wrench • Polished finish



Retail	Pipe/Tube	Rod Holder I.D.
F31-2721BXY-1	1-1/16" & 1-5/16" O.D. (Pipe)	1-3/4"
F31-2731BXY-1	1-11/16" & 1-15/16" O.D. (Pipe)	1-3/4"



F31-2721

Plastic Clamp-On

- Two sizes available for use on T-tops & bow rails • Glass-reinforced nylon
- Offered in black and white

Retail	Pipe/Tube	Rod Holder I.D.	Color
F41-2700BKA-1	7/8" - 1" (Tube)	1-3/4"	Black
F41-2720BKA-1	1-1/16" & 1-5/16" O.D. (Pipe)	1-3/4"	Black
F41-2700WHA-1	7/8" - 1" (Tube)	1-3/4"	White
F41-2720WHA-1	1-1/16" & 1-5/16" O.D. (Pipe)	1-3/4"	White



F41-2700

Rail Mount

- Fits 7/8" and 1" bow rails

Retail	Description	Rod Holder I.D.	Color
P04-041W	Rail Mounted Rod Holder	1-3/4"	White



P04-041W

Please refer to page REF100-101 for conversion, color and finish information



Call 800.226.8201 Boat Builders & Accessory Manufacturers
Call 800.653.8568 Aftermarket Distributors
TACOMarine.com

Gunnel Mount Rod Holder Accessories

- Anodized aluminum • Increase rods on board • Fit standard gunnel rod holders • Brushed finish

Kite Fishing Rod Cluster

- Gunnel mount kite fishing 3-rod holder • 15° bent shaft for clearance
- Fits all standard gunnel rod holders

Bulk	Retail	Rod Holder I.D.	Finish
F31-0770BSA-A	F31-0770BSA-1	1-3/4"	Brushed



F31-0770

Rod Rigger

- Mounts in the gunnel for universal use on all boats • Nylon safety strap ensures the rod stays on-board

Retail	Rod Holder I.D.	Finish
F31-0510BSA-1	1-3/4"	Brushed



F31-0510

Surface Mount Rod Holders

90° Rod Holder with Mounting Pad

- Anodized aluminum • Adjust, add and remove rod holder with standard Allen wrench
- Small stationary mounting pad ideal for transoms • Polished finish

Retail	Description	Finish
F31-2791BXY-1	90° Rod Holder w/Mounting Pad	Polished



F31-2791

Stand-Off Mount

- UV-stabilized polyethylene • Front-access hole & integrated stand-offs for easy mounting

Thru-Bolt Mount

- Front access hole • Pre-drilled mounting holes



Stand-Off Mount



Thru-Bolt Mount

Retail	Description	Rod Holder I.D.	Color
Stand-Off Mount			
P04-091W	Poly Stand-Off Rod Holders, Box of 24	1-3/4"	White
P04-0111W	Poly Stand-Off Rod Holders w/Stainless Hardware	1-3/4"	White
Thru-Bolt Mount			
P04-011W	Poly Rod Holder w/Mounting Holes	1-3/4"	White

Please refer to page REF100-101 for conversion, color and finish information

Call 800.226.8201 Boat Builders & Accessory Manufacturers
 Call 800.653.8568 Aftermarket Distributors
TACOMarine.com



Sport Fishing



Rod Storage

- Safe and secure storage for rods & reels
- Versatile mounting options – horizontal, vertical and overhead
- Available in a variety of styles, materials and color

Stainless Steel Type 316

Rod Hangers

- Spring locking rod tip holder • Delrin inserts • Hidden installation screws



Rod Hanger Design

Rod tip spring design securely locks rods in position. Durable and attractive polished stainless steel with white Delrin insert.



F16-2700-1

Bulk	Retail*	Description	Footprint	Color	Finish
-	F16-2700-1	Stationary Rod Hanger & Revolving Rod Tip Holder Kit	2-3/4" x 1"	White	Polished
F19-0006-1	-	Revolving Rod Tip Holder	-	White	Polished
F19-0006-2	-	Stationary Rod Hanger	-	White	Polished

*Clam shell pack (each)

Rod Hanger Racks

- Durable, UV-stabilized poly racks • Three sizes for convenient 2-, 3- & 4-rod storage
- Pre-drilled mounting holes and beveled edges install easily and offer a clean look
- Mount vertically, horizontally and overhead

Patent #7,228,655

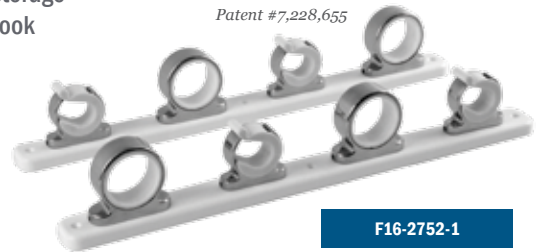

F16-2752-1

Retail	Description	Color	Finish
F16-2751-1	2-Rod Hanger w/Poly Rack	White	Polished
F16-2752-1	4-Rod Hanger w/Poly Rack	White	Polished
F16-2753-1	3-Rod Hanger w/Poly Rack	White	Polished

Reel Hangers / Reel Hanger Kit

- Corrosion-resistant, stainless steel spring secures reel into position
- Adjustable to fit most popular trolling reels
- Easy adjustment accommodates a variety of reel sizes

Adjustable stainless steel reel hangers securely store trolling reels on ceiling or gunnel. Fits most popular trolling reels.



Reel Hanger Kit



F16-2810 • F16-2820

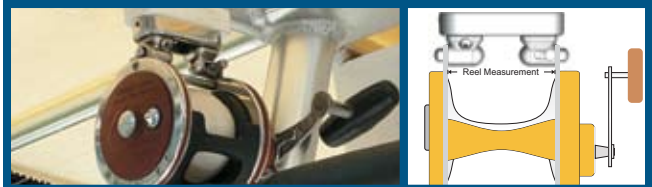

Bulk	Retail*	Description	Reel Measurement	Footprint
F16-2810	-	Reel Hanger	1.875" to 3.875"	1-1/8" x 4"
-	F16-2810-1	Reel Hanger w/Rod Tip Holder Kit	1.875" to 3.875"	1-1/8" x 4"
F16-2820	-	Reel Hanger	1.875" to 4.625"	1-1/8" x 4-7/8"
-	F16-2820-1	Reel Hanger w/Rod Tip Holder Kit	1.875" to 4.625"	1-1/8" x 4-7/8"

*Clam shell pack (each)

Please refer to page REF100-101 for conversion, color and finish information



Call 800.226.8201 Boat Builders & Accessory Manufacturers
Call 800.653.8568 Aftermarket Distributors
TACOMarine.com

Aluminum

Transom Mount Rod Rack

- Durable brushed, anodized aluminum • Patent-pending spline adjustments for rod holder angle and rack to fit the contour of the transom

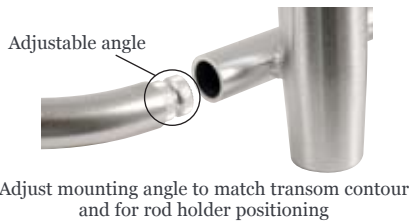

F31-3503



Bulk	Retail	Description	RH Length	RH I.D.	Overall Length	Finish
F31-3503BSA	F31-3503BSA-1	3-Rod Transom Mount Rack	10"	1-7/8"	34"	Brushed
F31-3504BSA	F31-3504BSA-1	4-Rod Transom Mount Rack	10"	1-7/8"	40-1/2"	Brushed

Rod Rack

- Brushed finish • Offered with 2-, 3- & 4-rod holders • Hidden fasteners

Aluminum Rod Rack features stylish rod storage for light tackle spinning rod and reel combos. Slotted opening locks in rods for secure storage.

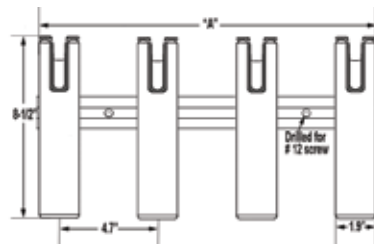

F31-3004

Bulk	Retail	Description	"A"	RH I.D.	Finish
F31-3002BSA	F31-3002BSA-1	2-Rod Holder Rack	6-5/8"	1-1/2"	Brushed
F31-3002BXY	-	2-Rod Holder Rack	6-5/8"	1-1/2"	Polished
F31-3003BSA	F31-3003BSA-1	3-Rod Holder Rack	11-1/4"	1-1/2"	Brushed
F31-3003BXY	-	3-Rod Holder Rack	11-1/4"	1-1/2"	Polished
F31-3004BSA	F31-3004BSA-1	4-Rod Holder Rack	16"	1-1/2"	Brushed
F31-3004BXY	-	4-Rod Holder Rack	16"	1-1/2"	Polished

Polyethylene

Poly Rod Rack

- Durable polyethylene to withstand the harsh marine environment • Flared rod holder for easy rod handling
- Slotted rod holders lock in most conventional and spinning outfits • Deluxe racks feature convenient integrated slots for knife and pliers
- Light racks feature closer rod holder spacing; ideal when space is limited • Available in 2-, 3- & 4-rod storage sizes

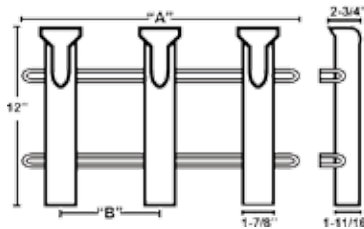

P03-153W



P03-062B



P03-063W



Retail	Description	Rack Style	"A"	"B"	RH I.D.	Color
P03-062B	2-Rod Poly Rod Rack	Deluxe	11-1/2"	6-1/2"	1-3/4"	Black
P03-062W	2-Rod Poly Rod Rack	Deluxe	11-1/2"	6-1/2"	1-3/4"	White
P03-063B	3-Rod Poly Rod Rack	Deluxe	18"	6-1/2"	1-3/4"	Black
P03-063W	3-Rod Poly Rod Rack	Deluxe	18"	6-1/2"	1-3/4"	White
P03-064B	4-Rod Poly Rod Rack	Deluxe	18"	4-1/2"	1-3/4"	Black
P03-064W	4-Rod Poly Rod Rack	Deluxe	18"	4-1/2"	1-3/4"	White
P03-153B	3-Rod Poly Rod Rack	Light	12"	3-3/4"	1-3/4"	Black
P03-153W	3-Rod Poly Rod Rack	Light	12"	3-3/4"	1-3/4"	White

Please refer to page REF100-101 for conversion, color and finish information

Call 800.226.8201 Boat Builders & Accessory Manufacturers
Call 800.653.8568 Aftermarket Distributors
TACOMarine.com



Pedestal Systems

TACO METALS partners with Netherlands-based Zwaardvis, a leader in Europe recognized for supplying quality, engineered marine pedestals systems. The European design, engineering, and workmanship is readily apparent.

Zwaardvis seat and table pedestals are constructed from strong, corrosion-resistant materials and carry a 3-year warranty. Marine grade stainless steel, anodized aluminum alloys and injection molded resins ensure long lasting protection from constant exposure to the harsh elements of sun and saltwater.

TACO's pedestal systems include a wide range of interchangeable columns, supports, bases and accessories needed to create table and seat pedestal systems in a variety of sizes and styles to suit the application.

SEAT PEDESTAL SYSTEMS

TACO's Poseidon seat pedestal systems are designed for ease of use and lasting performance. Poseidon pedestals are constructed using the finest premium materials and components. Anodized aluminum columns with marine grade stainless steel components, Delrin bearings, and gas-assisted height adjustment combine to offer superior quality and performance. The addition of a TACO seat support and slide assembly components allow for full 360° swivel and fore/aft slide.

TABLE PEDESTAL SYSTEMS

Zwaardvis pedestals are offered in a variety of sizes and styles. The exclusive new Triton 3-stage table pedestal system offers three locking height positions. Strong stainless steel locking mechanisms with single-motion clamps to secure positioning.

TACO also offers a line of removable side mount table pedestal systems. These polished stainless steel table pedestals are designed for easy removal and storage when not in use. The new line of adjustable side mount table pedestals offer adjustable tilt table mounts and telescoping locking leg for a table pedestal system that adapts to the angle of any boats gunnel, regardless of the contour.

CUSTOM REQUIREMENTS

For requirements outside the stocked products offered in this catalog, TACO will customize columns to the fixed or adjustable height needed to match specific boat designs.



81

Poseidon Seat Pedestal Systems

82

Adjustable Seat Pedestal Systems

83

Triton 3-Stage Table Pedestal System

84

Fixed Table Pedestal Systems

86

Adjustable Table Pedestal Systems

89

Seat & Accessories



Poseidon Seat Pedestal Systems

- Solid anodized aluminum and stainless steel construction
- Available with adjustable and fixed height options
- Power-Matic model features effortless gas-assist height adjustments
- Full range of adjustments including height, fore/aft and 360° swivel

FEATURE PRODUCT

Poseidon Seat Pedestal Systems



Precision engineered and built to last, the Poseidon anodized aluminum pedestal with optional Pacific Helm chair is extremely durable, comfortable and functional.

Poseidon adjustable pedestal systems feature anodized aluminum column with polished stainless steel lock-in clamps. Power-Matic pedestals offer effortless gas-assisted seat height adjustments.

Seat support and slide assembly with Delrin bearings provide smooth fore/aft slide and 360° full rotation with locking seat positions every 15°. All Zwaardvis-designed seat pedestals comply with ABYC H-31 requirements.



Poseidon pedestal with Power-Matic Column and Pacific Helm chair

Seat Columns Assembly

Poseidon Power-Matic Column & Seat Slide

- Anodized aluminum
- Satin finish seat support and tapered base (100mm/76mm)
- Seat support features Delrin bushings for smooth 360° rotation and 6" fore/aft slide
- Stainless steel locking clamps and collar
- Power-Matic, gas-assist seat height adjustments for effortless control

Bulk	Height Range	Top Tube O.D.	Bottom Tube O.D.	Base Dia.
Z80-3001VEL-PM	14-1/2" to 18-1/8"	76mm (3")	100mm (4")	300mm (11-7/8")
Z80-3002VEL-PM	17-3/4" to 21-3/8"	76mm (3")	100mm (4")	300mm (11-7/8")
Z80-3003VEL-PM	20-7/8" to 24-3/8"	76mm (3")	100mm (4")	300mm (11-7/8")
Z80-3004VEL-PM	24-7/8" to 28-3/8"	76mm (3")	100mm (4")	300mm (11-7/8")

Re-engineered Poseidon Pedestal

offers added strength, stability and a sleek appearance.

- Engineered with internal I-beams for excellent lateral support
- Improved locking mechanism for added stability
- Locks in height with one simple motion
- Attractive, polished stainless steel collars and clamps



Please refer to page REF100-101 for conversion, color and finish information

Call 800.226.8201 Boat Builders & Accessory Manufacturers
Call 800.653.8568 Aftermarket Distributors
TACOMarine.com





Adjustable Seat Pedestal Systems

- Columns, supports and bases
- Power-Matic adjustable height positions
- Anodized aluminum
- ABYC H-31 compliant

Adjustable Seat Pedestal Systems

Seat Support

- Aluminum • Manually adjustable • Cast aluminum seat support allows for 360° rotation • Accepts single tapered column

Bulk	Length	Width	Column O.D.	Finish
Z20-3760PCS60MM	9-7/16"	9-7/16"	60mm (2-3/8")	Powder Coat Silver



Z20-3760



The Zwaardvis adjustable seat pedestal line is designed for the medium to large cruiser market. All columns are single tapered on the bottom to permit a secure fit into the base while allowing for easy removal and storage. Adjustable columns are available in manual or Power-Matic variations. Power-Matic pedestals contain gas-assisted cylinders for the ultimate in precise and convenient adjustment.

The seat support allows for full, 360° rotation and contains an internal locking mechanism for a secure fit to the pedestal.

For custom requirements, TACO will customize pedestals to fit specific boat designs. Pedestals can be engineered and manufactured for fixed heights or adjustable to a custom height range.

Power-Matic Adjustable Seat Column

- Aluminum • Tapered bottom with locking ring connecting column and support for security

Bulk	Range	Top Tube O.D.	Bottom Tube O.D.	Finish
Z80-2190VEL-PM	19-1/8" - 32-1/2"	60mm (2-3/8")	76mm (3")	Satin Anodized



Power-Matic

Seat Bases

- Aluminum • Bases are tapered for secure fit

Bulk	Description	Column O.D.	Base O.D.	Finish
Z10-4070BLY76MM	Surface Mount Base	76mm (3")	9-7/8"	Brite Anodized



Z10-4070

Please refer to page REF100-101 for conversion, color and finish information



Call 800.226.8201 Boat Builders & Accessory Manufacturers
 Call 800.653.8568 Aftermarket Distributors
TACOMarine.com



Table Pedestal Systems

- Engineered for high performance
- Fixed and adjustable styles

FEATURE PRODUCT

Triton 3-Stage Table Pedestal System

- › Three tapered columns (100mm, 76mm & 60mm) offer added strength and three height positions.
- › Stainless steel one-motion clamping mechanism lock-in 3 table height positions.
- › Keyed columns prevent rotation
- › Precision engineering with Delrin bearings for smooth trouble-free operation
- › Smooth, satin finish



NEW!



Triton 3-Stage Table Pedestal Systems

Table Columns

- 3-Stage manually adjustable • Anodized aluminum • Delrin bearings for smooth operation • Smooth column

Bulk	Length	Top Tube O.D.	Bottom Tube O.D.	Finish
Z80-4101VEL	13-3/8" to 26-3/8"	60mm (2-3/8")	100mm (4")	Satin Anodized
Z80-4102VEL	13-3/4" to 27-1/8"	60mm (2-3/8")	100mm (4")	Satin Anodized
Z80-4103VEL	14-1/8" to 28"	60mm (2-3/8")	100mm (4")	Satin Anodized

- 3-Stage Power-Matic adjustable • Gas shock provides smooth operation of column adjustment
- Anodized aluminum • Delrin bearings for smooth operation

Bulk	Length	Top Tube O.D.	Bottom Tube O.D.	Finish
Z80-4001VEL-PM	14-1/8" to 28"	60mm (2-3/8")	100mm (4")	Satin Anodized
Z80-4002VEL-PM	15-1/4" to 29"	60mm (2-3/8")	100mm (4")	Satin Anodized



Pedestal Systems

Please refer to page REF100-101 for conversion, color and finish information

Call 800.226.8201 Boat Builders & Accessory Manufacturers
Call 800.653.8568 Aftermarket Distributors
TACOMarine.com



76mm (3") Fixed Table Pedestal Systems

Table Support

- Aluminum • Bow-tie design provides superior table support in a shallow profile for increased leg room



Fixed Height System (Dual Taper)



Fixed Height System (Single Taper)

The Zwaardvis 76mm Fixed Table Pedestal line is designed for the medium cruiser market. All columns are single tapered on the bottom to permit a secure fit into the base while allowing for easy removal and storage.

Table support options allow for fixed or leaf tables. Fixed tables are designed to receive a dual tapered column while the leaf supports receive a single tapered column. Both styles permit removal of the table surface for convenient storage.

The Zwaardvis table pedestal systems provide a wide array of base options to cover most applications. All bases are designed to accept the innovative Zwaardvis tapered column for convenient removal and storage.

For custom requirements, TACO will customize pedestals to fit specific boat designs. Pedestals can be engineered and manufactured for fixed heights and adjustable to a custom height range.

Bulk	Length	Width/Dia.	Column Taper	Finish
Z10-4070BLY76MM	-	9-7/8"	Dual	Brite Anodized
Z20-3161PCS76MM	19-3/4"	9-7/8"	Single	Powder Coat Silver



Table Columns

- Aluminum • 76mm (3") diameter • Custom lengths available upon request

Bulk	Length	Taper	Finish
Z76-7143VEL11.25-1	11-1/4"	Single	Satin Anodized
Z76-7143VEL13.25-1	13-1/4"	Single	Satin Anodized
Z76-9266VEL26.63-1	26-5/8"	Single	Satin Anodized
Z76-9271VEL28.63-1	28-5/8"	Single	Satin Anodized
Z76-7333VEL12-2	12"	Dual	Satin Anodized
Z76-7352VEL16.81-2	16-13/16"	Dual	Satin Anodized
Z76-7392VEL32-2	32"	Dual	Satin Anodized
Z76-9066VEL26-2	26"	Dual	Satin Anodized
Z76-9071VEL28-2	28"	Dual	Satin Anodized

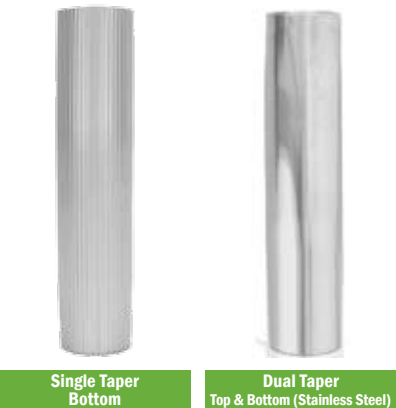

- Polish stainless steel • 76mm (3") diameter • Also available in custom lengths

Bulk	Length	Taper	Finish
Z76-8000POL25.5-1	25-1/2"	Dual	Polished
Z76-8000POL28-2	28"	Dual	Polished

Table Bases

- Bases are tapered for secure fit



Bulk	Description	Base O.D.	Finish
Z10-4065PCS76MM	Surface Mount	10-1/2"	Powder Coat Silver
Z10-4070BLY76MM	Surface Mount	9-7/8"	Brite Anodized
Z10-4080BLY76MM	Flush Mount	8-5/8"	Brite Anodized
Z10-4097POL	Flush Mount	6"	Polished Stainless Steel

Please refer to page REF100-101 for conversion, color and finish information



Call 800.226.8201 Boat Builders & Accessory Manufacturers
 Call 800.653.8568 Aftermarket Distributors
TACOMarine.com

60mm (2-3/8") Fixed Table Pedestal Systems

Table Support

- Aluminum • Anodized aluminum, designed for fixed table tops and dual taper columns



Z10-4067



Z10-4075

Bulk	Base O.D.	Column Type	Finish
Z10-4067BLY60MM	7"	Dual Taper	Brite Anodized
Z10-4075BLY60MM	9-7/8"	Dual Taper	Brite Anodized

Fixed Height System

The Zwaardvis 60mm Fixed Table

Pedestals are engineered with aluminum extrusions and a variety of castings specifically for the small cruiser market where space is at a premium. All columns are tapered on the bottom to permit a secure fit into the base while allowing for easy removal and storage.

TACO columns are available with smooth, contemporary surface or traditional ribbed surface.

Table support options allow for fixed table tops receiving a dual tapered top column. The 60mm system is ideal for smaller diameter table tops in particularly tight quarters.

TACO introduces the new Z10-4086, base with a shorter cup design, ideal when space is limited below the deck.

The Zwaardvis table pedestal systems provide a wide array of base options to cover



Table Columns

- Aluminum • Offered in smooth and ribbed • Satin anodized aluminum with dual taper

Bulk	Length	Style	Finish
Z60-7239VEL13-2S	13"	Smooth	Satin Anodized
Z60-7239VEL24.5-2S	24-1/2"	Smooth	Satin Anodized
Z60-7254VEL17.25-2S	17-1/2"	Smooth	Satin Anodized
Z60-7239VEL13-2	13"	Ribbed	Satin Anodized
Z60-8266VEL26-2	26"	Ribbed	Satin Anodized



Smooth Column



Ribbed Column

Table Bases

- Bases are tapered for secure fit



Z10-4067



Z10-4075



Z10-4085

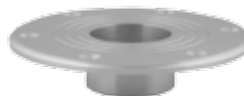

Z10-4086



Z10-4087

Bulk	Description	Base O.D.	Finish
Z10-4067BLY60MM	Surface Mount	7"	Brite Anodized
Z10-4075BLY60MM	Surface Mount	9-7/8"	Brite Anodized
Z10-4085BLY60MM	Flush Mount	7-1/16"	Brite Anodized
Z10-4086BLY60MM	Flush Mount - Low Profile	6-7/8"	Brite Anodized
Z10-4087POL	Flush Mount	5-1/2"	Polished Stainless Steel

Pedestal Systems

Please refer to page REF100-101 for conversion, color and finish information

Call 800.226.8201 Boat Builders & Accessory Manufacturers
 Call 800.653.8568 Aftermarket Distributors
TACOMarine.com



Adjustable Table Pedestal Systems

TACO's line of Zwaardvis table pedestal systems offer a wide array of options, designed for the medium cruiser market. All columns are tapered at the bottom for a secure fit while allowing easy removal and storage. Adjustable columns are available in manual or Power-Matic variations. Power-Matic pedestals contain gas-assisted cylinders for the ultimate in precise and convenient adjustment.

Table Support

- Aluminum • Bow-tie design provides superior table support in a shallow profile for increased leg room



Z20-3160



Z20-3180

Bulk	Length	Width	Taper	Finish
Z20-3160PCS60MM	19-3/4"	7-1/4"	Single	Powder Coat Silver
Z20-3180PCS60MM	11-3/16"	7-3/16"	Single	Powder Coat Silver

Table Columns

- Anodized aluminum • Smooth surface • Polished, stainless steel collars and locking clamps

Bulk	Length	Top Tube O.D.	Bottom Tube O.D.	Finish
Z80-2090VEL	19-1/4" to 32-1/4"	60mm (2-3/8")	76mm (3")	Satin Anodized

- Anodized aluminum • Power-Matic adjustable • Gas shock provides smooth operation of column adjustment
- Delrin bearings for smooth operations • Smooth surface • Polished, stainless steel collars and locking clamps

Bulk	Length	Top Tube O.D.	Bottom Tube O.D.	Finish
Z80-2190VEL32.5	19-1/4" to 32-1/4"	60mm (2-3/8")	76mm (3")	Satin Anodized

- Aluminum • Power-Matic thru-deck adjustable • Smooth surface • Polished, stainless steel collars and locking clamps

Bulk	Length	Top Tube O.D.	Bottom Tube O.D.	Finish
Z80-2600VEL-PM	14-3/8" to 27-3/4"	60mm (2-3/8")	76mm (3")	Satin Anodized



Manual Column
Power-Matic Column

Table Bases

- Bases are tapered for secure fit



Z10-4065



Z10-4070



Z10-4080



Z10-4097

Bulk	Description	Column O.D.	Base O.D.	Finish
Z10-4065PCS76MM	Surface Mount	76mm (3")	10-1/2"	Powder Coat Silver
Z10-4070BLY76MM	Surface Mount	76mm (3")	9-7/8"	Brite Anodized
Z10-4080BLY76MM	Flush Mount	76mm (3")	8-5/8"	Brite Anodized
Z10-4097POL	Flush Mount	76mm (3")	6"	Polished Stainless Steel

Please refer to page REF100-101 for conversion, color and finish information



Call 800.226.8201 Boat Builders & Accessory Manufacturers
Call 800.653.8568 Aftermarket Distributors
TACOMarine.com

FEATURE PRODUCT

Adjustable Side Mount Table Pedestal System

TACO's stainless steel removable table pedestal systems for interiors and exterior are ideal, especially when space is limited. Table mount adjusts table angle and locks in place with heavy-duty cam locking lever. Polished stainless steel telescoping leg extends offering three locking positions. Leg removes easily for storage and security.

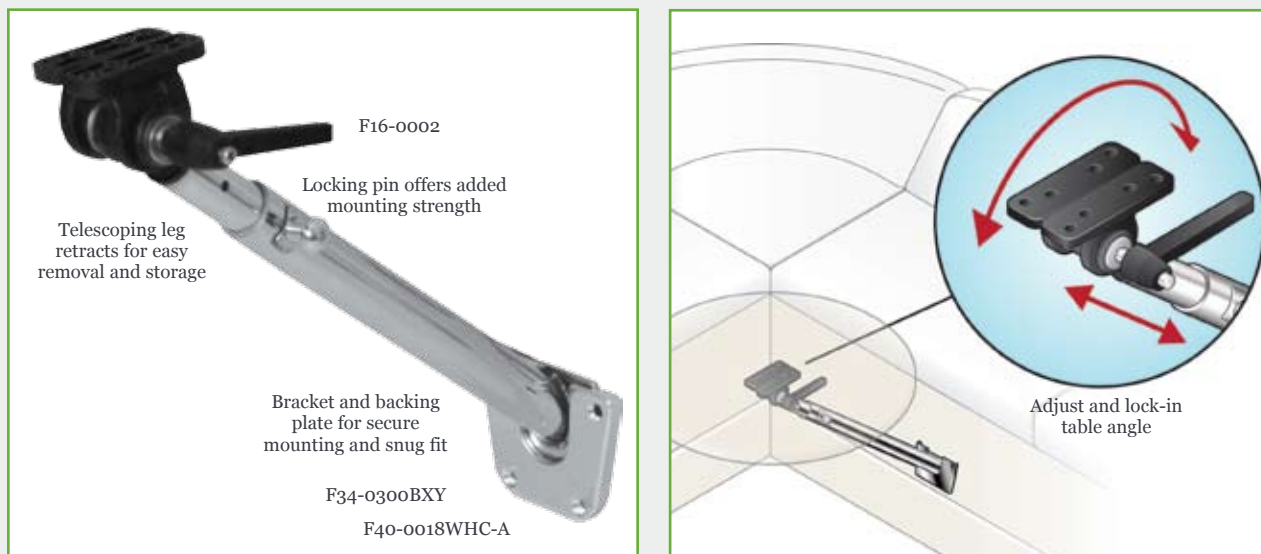

Removable Side Mount with Adjustable Tilt

Stainless Steel

- Polished stainless steel 3-position telescoping leg • Removable for clear passage and easy storage
- Polished aluminum mounting bracket • Ideal for interiors and exteriors



F16-0002
Telescoping Leg



F34-0300
Mounting Bracket



F40-0018
Backing Plate

Bulk	Description	Dimensions	Tube	Flange	Hole*	Color/Finish
F16-0002	Telescoping Pedestal w/Adjustable Tilt Mount	13"W to 18"W ; 11-1/2"H to 16"H	1-1/2"	-	-	Polished
F34-0300BXY	Anodized Aluminum Mounting Bracket	4-7/8"W x 4"H x 1/2"D	-	-	1/4"	Polished
F40-0018WHC-A	Backing Plate	2-1/2"W x 4"H x 5/32"D	-	-	1/4"	Frosty White

*Drilled for #10 flat head screw

Please refer to page REF100-101 for conversion, color and finish information

Call 800.226.8201 Boat Builders & Accessory Manufacturers
Call 800.653.8568 Aftermarket Distributors
TACOMarine.com



FEATURE PRODUCT

Fixed Angle Side Mount Table Pedestal System

TACO's stainless steel removable table pedestal systems for interiors and exterior are ideal, especially when space is limited. Polished stainless steel leg removes easily for storage and security.

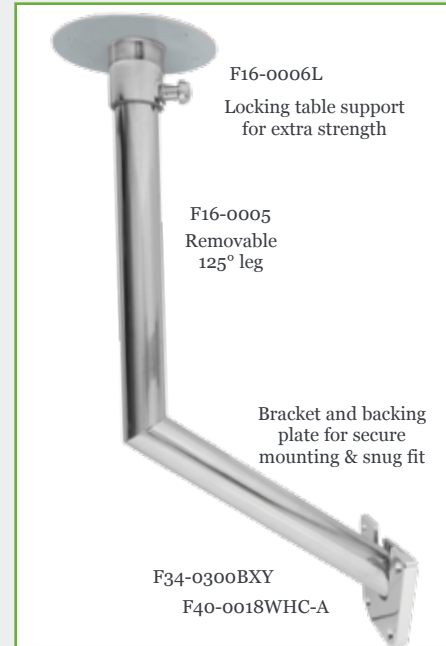
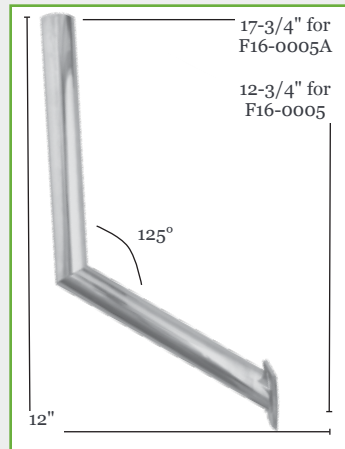

Removable Side Mount Table Pedestal

Stainless Steel

- Removable for clear passage and easy storage
- Locking pin offers added mounting strength
- Polished aluminum mount bracket
- 125° bent leg
- Ideal for interiors and exteriors



Bulk	Description	Dimensions	Tube	Flange	Hole*	Color/Finish
F16-0005	Stainless Steel Side Mount Table Pedestal	12"W x 12-3/4"H	1-5/8"	-	-	Polished
F16-0005A	Stainless Steel Side Mount Table Pedestal	12"W x 17-3/4"H	1-5/8"	-	-	Polished
F16-0006L	Stainless Steel Table Support w/Locking Pin	-	1-5/8"	6-1/4"	-	Polished
F34-0300BXY	Anodized Aluminum Mounting Bracket	4-7/8"W x 4"H x 1/2"D	-	-	1/4"	Polished
F40-0018WHC-A	Backing Plate	2-1/2"W x 4"H x 5/32"D	-	-	1/4"	Frosty White

*Drilled for #10 flat head screw

Please refer to page REF100-101 for conversion, color and finish information



Call 800.226.8201 Boat Builders & Accessory Manufacturers
 Call 800.653.8568 Aftermarket Distributors
TACOMarine.com



Seat & Accessories

- Luxurious leather helm chair
- Seat slide assembly offers smooth fore/aft movement
- Variety of accessories

Seating

Pacific

- A luxurious seat for the ultimate in comfort and class • Features high seat back with fully adjustable arm rests, seatback and headrest
- All polished stainless steel hardware and rich leather upholstery • Ideal helm chair on enclosed bridges

Bulk	Description	Dimensions
Z99-2000DGA	Gray Leather	24"W x 23"D x 37"H



Z99-2000

Slide Assembly Component

Aluminum

- Add to any seat system to provide smooth movement forward and aft • Satin anodized aluminum finish

Bulk	Description	Length	Width	Finish
Z30-4220VEL	Seat Slide Assembly	19"	9-7/8"	Satin Anodized



Z30-4220

Accessories

Flush Mount Base Plug

- Covers open base holes upon removal of column • Prevents water accumulation

Bulk	Column O.D.	Material
Z10-4016DEL76MM-A	76mm (3")	Delrin
Z10-4026DEL60MM	60mm (2-3/8")	Delrin



Z10-4016

Carpet Ring

- Tapered for clean look • Perfect for trimming carpet (1/4" to 1/2" thick) around seat and table columns

Bulk	I.D.	O.D.	Material	Color
Z10-9998BKA	95mm (3-3/4")	146mm (5-3/4")	Santoprene	Black



Z10-9998

Pedestal Systems

Please refer to page REF100-101 for conversion, color and finish information

Call 800.226.8201 Boat Builders & Accessory Manufacturers
Call 800.653.8568 Aftermarket Distributors
TACOMarine.com



Accessories

TACO Metals offers a wide variety of marine accessories designed to offer convenience and enhance the overall boating experience.

The emergence of LED lights has revolutionized lighting by offering an efficient alternative to fluorescent and halogen lighting. LED lighting provides long-lasting, high output light with little or no radiant heat. TACO introduces its LUMA line of marine LED lights, designed and tested specifically for use in the marine environment. TACO offers low-draw, 12-28V DC hard-wired spot lights, deck lights, spreader lights and white/red switchable T-top lights. TACO also offers portable, rechargeable LED lights that charge quickly and last up to 3+ hours on a single charge.

The Pelican file table line includes file tables for docks and gunnels. The rugged Dock Side file table is a heavy-duty, permanent mounting file table with a generous size UV-resistant file table supported by stylish and durable polished anodized aluminum legs. TACO also offers a wide range of portable, gunnel mounting file tables featuring adjustable tilt and fixed angle tables.

Accessorizing boats has never been easier with TACO's durable UV-stabilized polyethylene tool holders and drink holders.

When it comes to replacing wood, laminates or plastic accessories on boats, or creating new ones, leading boat experts know they can count on TACO's Marine Lumber to last the lifetime of the boat. Marine Lumber is a UV-stabilized marine grade polymer sheet with excellent resistance to sun and saltwater and is maintenance free. Marine Lumber can be easily cut, routed, shaped, and drilled with standard woodworking tools and making it the ideal material to use for making marine accessories.

Marine



91	LED Lights
94	Filet Tables
95	Poly Accessories
96	Accessory-Ready™ Poly Accessories
98	Dock and Trailer
99	Marine Lumber

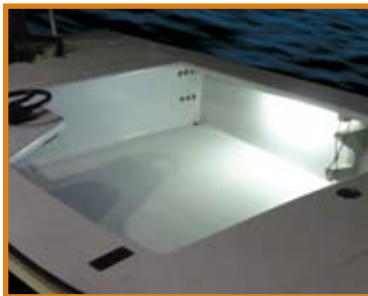

LED Marine Lighting

- Long-lasting, 100,000 operating hours
- High output, low heat
- Waterproof (non-submersion)
- Offered in hard-wired and rechargeable
- Variety of styles and mounting options

FEATURE PRODUCT



LED Marine Lighting

TACO introduces LUMA LED lights; a complete line of high efficiency LED lighting designed and tested* for use in the marine environment.



- › **Waterproof:** All connections, lenses, and housings are sealed to protect and prevent water penetration for non-submerged applications.
- › **Non-Corrosive:** Anodized aluminum, stainless steel and high grade plastic polymers were chosen for their non-corrosive attributes and ability to withstand harsh marine environment. All lights are salt water tested for 100 hours ensuring they meet TACO standards.
- › **Durable:** Shock/vibration-resistant; ideal for withstanding the pounding of high seas and the vibration from constant motor operation.

*All test results in accordance with IESNA LM-79-2008

Hard-Wired LED Lighting

T-top Lights

- Low < 1 amp draw • UV and impact-resistant polycarbonate lens • Switchable white/red light
- Bright, 300 lumens white light • Low glare, 150 lumens red light

LED T-top Lights feature 108 LEDs for bright, long-lasting white light ideal for lighting up T-tops, bridges, engine rooms, lockers, enclosures. Switch to red light for low glare chart reading.

A lengthy 18' of wiring cable to accommodate most tops and bridges. Pre-drilled housing or mounting clips offer fast and easy mounting to tops.

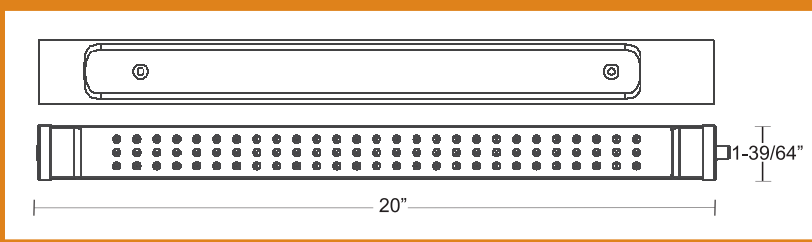

F38-2050-1



F38-2060-1

Bulk/Retail	Description	LEDs	Peak Lumens (l)	Length
F38-2050-1	LED T-top Light w/Polished Anodized Aluminum Housing	108 (72 White, 36 Red)	300l (White); 150l (Red)	20"L x 2" Diameter
F38-2060-1	LED T-top Light w/Mounting Clips	108 (72 White, 36 Red)	300l (White); 150l (Red)	20"L x 1-5/8" Diameter

Hard-Wired LED Lighting (Cont'd)

Deck & Spreader Lights

- Low < 1 amp draw • Universal 12 - 28V DC operation • Impact-resistant, sealed white housing with polycarbonate lens • Stainless steel tilt mounting bracket • Available with adjustable nylon clamp for clamp-on assembly to standard 1-1/16" & 1-5/16" O.D. T-top outer rings

Light up decks with LED Deck and Spreader Lights. High output bright white light provides 100,000 hours of operation that won't drain batteries, drawing less than 1 amp. Choice of output power for use on boats of all size. Waterproof to withstand saltwater spray and wash downs.



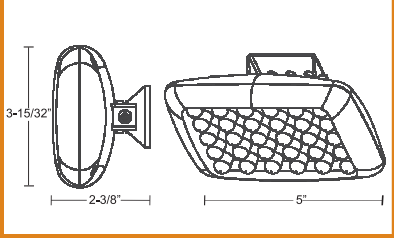

F38-3500WHA-1

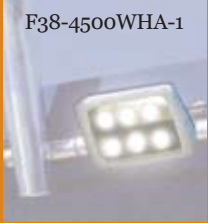

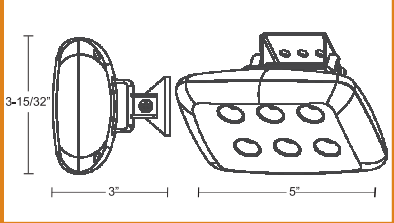

F38-4500WHA-1





F38-3521WHA-1

Spreader light output comparable to 50W Halogen



F38-4500WHA-1

Spot Light

- High powered 1,000,000 candlepower • 12 - 28V DC power • Impact-resistant white housing with polycarbonate lens
- Stainless steel tilt bracket for mounting to pipe • Available with heavy-duty adjustable nylon clamp for clamp-on assembly to standard 1-1/16" & 1-5/16" T-top outer rings

Light up the waters ahead with 1,000,000 candlepower LED Spot light. Durable and impervious to saltwater, fresh water and pounding wakes. Long-lasting 100,000 hours of operation that won't drain batteries.



F38-5500WHA-1



F38-5520WHA-1

Clamp

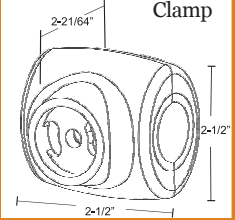

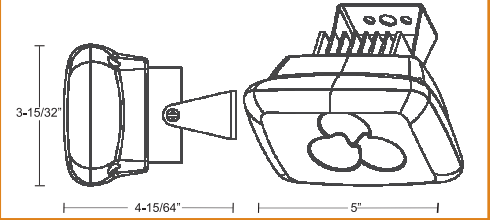

Bulk/Retail	Description	LEDs	Peak Lumens (l)	Spread
F38-3500WHA-1	LED Deck Light w/Adjustable Tilt Mount	30	150	120°
F38-3521WHA-1	LED Deck Light w/Adjustable Clamp for 1-1/16" & 1-5/16" O.D. Pipe	30	150	120°
F38-4500WHA-1	LED Spreader Light	6	675	150°
F38-4520WHA-1	LED Spreader Light w/Adjustable Clamp for 1-1/16" & 1-5/16" O.D. Pipe	6	675	150°
F38-5500WHA-1	LED Spot Light	3	4,474	22.2° Vertical/ 25° Horizontal
F38-5520WHA-1	LED Spot Light w/Adjustable Clamp for 1-1/16" & 1-5/16" O.D. Pipe	3	4,474	22.2° Vertical/ 25° Horizontal

Please refer to page REF100-101 for I.P.S. conversion



Call 800.226.8201 Boat Builders & Accessory Manufacturers
 Call 800.653.8568 Aftermarket Distributors
TACOMarine.com

Rechargeable LED Lighting

Rechargeable LED Lighting operate up to 3 hours on a single charge for long-lasting bright white light. Lightweight and portable for hands-free operation. TACO rechargeables also offer versatile mounting for use anywhere on board.

Bright Stick, Deep Drop, Work Light

- Up to 3+ hours on a charge • Includes AC/DC charger and lighter adapter • Variety of styles offered with various mounting options

The Bright Stick

include suction cups, mounting clips and magnets for use down below or on windshields, gunnels, lockers and Bimini tops.



F38-2020-1

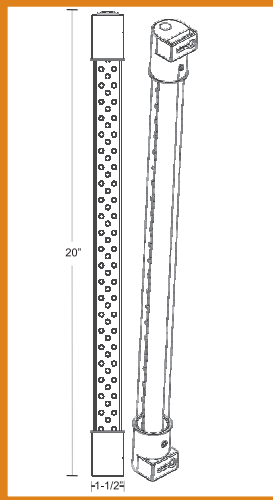

The Deep Drop Float Light

with bright green light enhances fish activity. Water-tight outer tube is naturally buoyant for surface use. Add weight for use in depths to 100'.

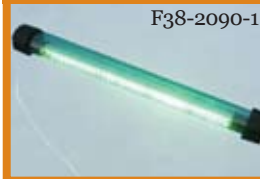

F38-2090-1

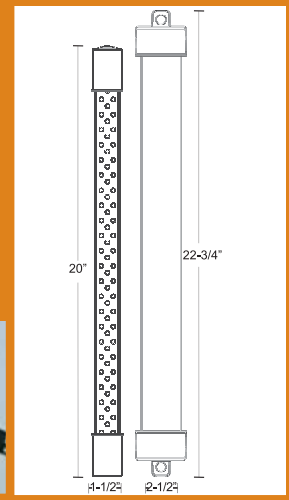

The Blue Work Light

is a great task light offering heavy-duty grip and stainless steel swivel hook ideal for work in small, confined areas.



F38-2500-1

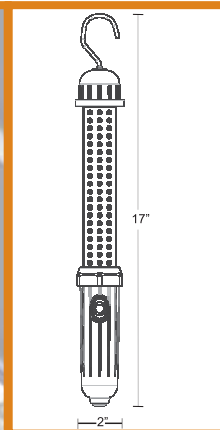

F38-2020-1

F38-2090-1

F38-2500-1

Retail	Description	Spreader			
		LED	Flashlight	LEDs	Peak Lumens (l)
F38-2020-1	LED Bright Stick Light w/Suction Cup & Mounting Clips	25'W x 30'D	5'W x 15'D	108	600
F38-2090-1	LED Deep Drop Waterproof Light	15'W x 30'D	5'W x 15'D	108	600
F38-2500-1	LED Work Light w/Stainless Steel Swivel Hook	25'W x 30'D	5'W x 15'D	60	250



Filet Tables

- UV-stabilized, high density polyethylene
- FDA approved tables
- Dock-side table for permanent mounting
- Gunnel tables mount securely in gunnels



Dock Side Filet Table

- Permanently mounts on dock side
- Six 3/8" x 2.5" lag bolts secure each leg to the dock
- Water nozzle holder for convenient use and clean-up
- Drink holder mounts to the side
- Filet plier and knife holder slots
- Mounting hardware included
- 48" L x 37" H x 21" W
- Holds up to 250lbs.



P01-4821W

Adjustable Poly Filet Table

- Adjustable tilt
- FDA-approved table
- Includes stainless fasteners
- Slotted for plier and knife holder and drainage
- Rugged engineered nylon tilt mount
- Folds flat for storage
- Fits into any rod holder
- The mount locks at any angle



P01-2120W

Fixed Poly Filet Table

- FDA-approved table slotted for plier and knife holder and drainage
- Fixed angle mount
- Durable, anodized aluminum and UV-stabilized, high density polyethylene
- Stainless fasteners
- Offered in two sizes



P01-2120FW

Removable Bait Filet Board

- Stores flat
- Everything needed for mounting included
- Holds pliers and knife
- Heavy-duty, UV-stabilized polyethylene construction



P01-1613W

Retail	Description	Dimension	Color/Finish
P01-4821W	Dock Side Filet Table	48" x 37" x 21"	White/Brushed
P01-2120W	Adjustable Poly Filet Table	20" x 12"	White
P01-2132W	Adjustable Poly Filet Table	32" x 12"	White
P01-2120FW-1	Fixed Gunnel Mount Poly Filet Table	20" x 12"	White
P01-2132FW-1	Fixed Gunnel Mount Poly Filet Table	32" x 12"	White
P01-1613W	Removable Bait/Filet Board	16" x 13"	White



Poly Accessories



- UV-stabilized, high density polyethylene
- Hidden fasteners
- 1-, 2- & 3-drink holder styles

Drink Holders

- Hold full-sized insulated drink holders and mugs
- Offered in white
- Includes stainless steel mounting screws for flat or bulkhead mount
- Includes suction cup for easy add and remove



P01-2000W



P01-2001W



P01-2003W

Fishing Plier & Knife Holders

- Safe and convenient storage
- Both hold a pair of pliers and 2 knives
- Includes stainless steel mounting screws



P01-1000W



P01-1001W

Rigging Strips

- Stores pre-rigs, plugs and spoons
- 12" rig strip for any flat surface
- Pre-drilled holes
- Offered with marine grade self-adhesive or suction cup mounting



P01-1200W

Retail	Description
P01-2000W	2-Drink Poly Holder w/"Catch-All"
P01-2001W	2-Drink Poly Holder w/Suction Cup Mount
P01-2003W	1-Drink Poly Holder
P01-1000W	Plier & Knife Holder
P01-1001W	Plier, Knife & 15-Rig Holder
P01-1200W	Adhesive Mount Rigging Strip
P01-1201W	Suction Cup Mount Rigging Strip



Accessory-Ready™ Poly Accessories

- Includes female adapters
- Fits Neptune III Leaning Post and all male adapters
- FDA approved tables
- Drink holders



FEATURE PRODUCT

Accessory-Ready™ Poly Accessories

Accessorizing is easy with TACO's Accessory-Ready file table, fishing plier and knife holder and drink holders. The included Accessory-Ready female adapter makes these convenient poly accessories easy to add and remove, requiring only a standard Allen wrench .

Designed for use with the Neptune III Leaning Post (page MF58), these Accessory-Ready accessories can also be used in conjunction with TACO's Accessory-Ready male adapters (page MF55) for universal use on any T-tops, poling platforms and railing. Add a surface mount male adapter and add to gunnels and bulkheads.



Poly Filet Table

- Mounts horizontally • Fits Neptune III Leaning Post • Fits all male adapters • Includes female adapter mount
- FDA-approved table slotted for plier and knife holder and drainage • Durable, anodized aluminum and UV-stabilized, high density polyethylene • Offered in two sizes



Poly Filet Table P01-2120HW-1 added to Neptune III Leaning Post (L10-2000BSA-1)



P01-2120HW

Retail	Description	Dimension	Color
P01-2120HW-1	Horizontal Mount Poly Filet Table w/Accessory-Ready Female Adapter	20" x 12"	White
P01-2132HW-1	Horizontal Mount Poly Filet Table w/Accessory-Ready Female Adapter	32" x 12"	White

Accessory for use with Neptune III Leaning Post, page MF58 and Male Adapters, page MF55

Drink Holders

- Hold full-sized insulated drink holders and mugs • Includes female adapter • Fits Neptune III Leaning Post and all male adapters

2-Drink "Catch All" P01-2010W-1
with male adapter F36-2531BXY-1 added to a T-top cross member



P01-2010W-1



P01-2310W-1



Retail	Description	Color
P01-2010W-1	2-Drink Poly "Catch-All" w/Accessory-Ready Aluminum Female Adapter	White
P01-2310W-1	1-Drink Poly w/Accessory-Ready Aluminum Female Adapter	White

Accessory for use with Neptune III Leaning Post, page MF58 and Male Adapters, page MF55

Fishing Plier & Knife Holders

- Safe and convenient storage • Both hold a pair of pliers and 2 knives • Includes female adapter
- Fits Neptune III Leaning Post and all male adapters

Plier & Knife Holder
P01-1010W-1 added to Neptune III Leaning Post (L10-2000BSA-1)



P01-1010W-1



Retail	Description	Color
P01-1010W-1	Plier & Knife Holder w/Accessory-Ready Female Adapter	White

Accessory for use with Neptune III Leaning Post, page MF58 and Male Adapters, page MF55



Dock & Trailer Accessories



- Extruded rigid vinyl for durable, long-lasting protection

Dock Bumper

Flexible Vinyl

- Soft durometer absorbs impact and protects dock and boat from damage during docking
- Continuous coil allows seamless, one-piece installation
- Tight radius bending can be done with no heating

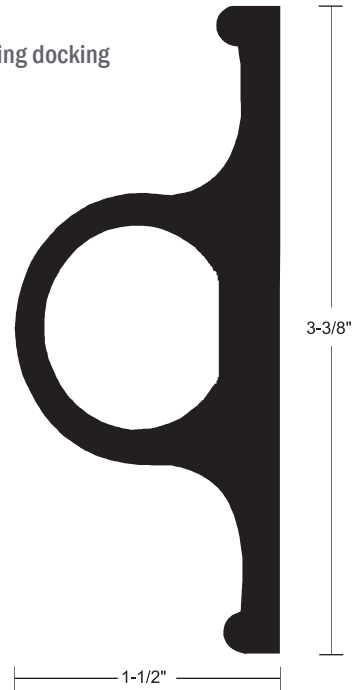

Bulk	Length	Height	Width	Color
V11-0948WHA25-1	25'	3-3/8"	1-1/2"	Arctic White

V11-0948

Trailer Glyde Slicks

- Eliminates friction between the bottom of the boat and the runners
- Easily installed on carpeted or bare bunks
- Evenly distribute the weight of the boat
- Designed for all boats – aluminum, fiberglass and wood
- Include stainless steel screws and instructions
- Dimensions: 2' L x 1-1/2" W - 7/16" Thick



P05-06W



P06-06W

Retail	Description
P05-06W	6Pc. 2' Trailer Glyde Strips
P06-06W	6Pc. 2' Premium Trailer Glyde Strips

Please refer to page REF101 for color and finish information



Call 800.226.8201 Boat Builders & Accessory Manufacturers
 Call 800.653.8568 Aftermarket Distributors
TACOMarine.com



Marine Lumber

- UV-stabilized, high density polyethylene
- Maintenance free
- Easily drilled, cut and routed
- Textured surface



Marine Lumber Sheets

- UV-stabilized marine grade polymer specifically designed to withstand harsh marine environments
- Individually shrink wrapped
- Excellent resistance to sun and salt water
- Ideal wood replacement for cabinets, dock and step boxes

Bulk	Retail*	Thickness	Dimension	Color
-	P10-2512WHA27-1	1/4"	12" x 27"	White
-	P10-2524BLK54-1	1/4"	24" x 54"	Black
-	P10-2524WHA27-1	1/4"	24" x 27"	White
-	P10-2524WHA54-1	1/4"	24" x 54"	White
-	P10-5012BLK27-1	1/2"	12" x 27"	Black
-	P10-5012SFM27-1	1/2"	12" x 27"	Seafoam
-	P10-5012WHA27-1	1/2"	12" x 27"	White
-	P10-5024BLK27-1	1/2"	24" x 27"	Black
-	P10-5024BLK54-1	1/2"	24" x 54"	Black
-	P10-5024SFM27-1	1/2"	24" x 27"	Seafoam
-	P10-5024SFM54-1	1/2"	24" x 54"	Seafoam
-	P10-5024WHA27-1	1/2"	24" x 27"	White
-	P10-5024WHA54-1	1/2"	24" x 54"	White
P10-5048BLK54	-	1/2"	48" x 54"	Black
P10-5048SFM54	-	1/2"	48" x 54"	Seafoam
P10-5048WHA54	-	1/2"	48" x 54"	White
P10-5096BLK54	-	1/2"	96" x 54"	Black
P10-5096SFM54	-	1/2"	96" x 54"	Seafoam
P10-5096WHA54	-	1/2"	96" x 54"	White
-	P10-7512BLK27-1	3/4"	12" x 27"	Black
-	P10-7512SFM27-1	3/4"	12" x 27"	Seafoam
-	P10-7512WHA27-1	3/4"	12" x 27"	White
-	P10-7524BLK27-1	3/4"	24" x 27"	Black
-	P10-7524BLK54-1	3/4"	24" x 54"	Black
-	P10-7524SFM27-1	3/4"	24" x 27"	Seafoam
-	P10-7524SFM54-1	3/4"	24" x 54"	Seafoam
-	P10-7524WHA27-1	3/4"	24" x 27"	White
-	P10-7524WHA54-1	3/4"	24" x 54"	White
P10-7548BLK54	-	3/4"	48" x 54"	Black
P10-7548SFM54	-	3/4"	48" x 54"	Seafoam
P10-7548WHA54	-	3/4"	48" x 54"	White
P10-7596BLK54	-	3/4"	96" x 54"	Black
P10-7596SFM54	-	3/4"	96" x 54"	Seafoam
P10-7596WHA54	-	3/4"	96" x 54"	White

*Shrink wrapped for retail merchandising



Marine Lumber

Reference

Conversion Chart

Fraction	Decimal	Millimeter
1/64	0.0156	0.3969
1/32	0.0313	0.7938
3/64	0.0469	1.1906
1/16	0.0625	1.5875
5/64	0.0781	1.9844
3/32	0.0938	2.3813
7/64	0.1094	2.7781
1/8	0.1250	3.1750
9/64	0.1406	3.5719
5/32	0.1563	3.968
11/64	0.1719	4.3656
3/16	0.1875	4.7625
13/64	0.2031	5.1594
7/32	0.2188	5.5563
15/64	0.2344	5.9531
1/4	0.2500	6.3500
17/64	0.2656	6.7469
9/32	0.2813	7.1438
19/64	0.2969	7.5406
5/16	0.3125	7.9375
21/64	0.3281	8.3344

Fraction	Decimal	Millimeter
11/32	0.3438	8.7313
23/64	0.3594	9.1281
3/8	0.3750	9.5250
25/64	0.3906	9.9219
13/32	0.4063	10.3188
27/64	0.4219	10.7156
7/16	0.4375	11.1125
29/64	0.4531	11.5094
15/32	0.4688	11.9063
31/64	0.4844	12.3031
1/2	0.5000	12.7000
33/64	0.5156	13.0969
17/32	0.5313	13.4938
35/64	0.5469	13.8906
9/16	0.5625	14.2875
37/64	0.5781	14.6844
19/32	0.5938	15.0813
39/64	0.6094	15.4781
5/8	0.6250	15.8750
41/64	0.6406	16.2719
21/32	0.6563	16.6688

Fraction	Decimal	Millimeter
43/64	0.6719	17.0656
11/16	0.6875	17.4625
45/64	0.7031	17.8594
23/32	0.7188	18.2563
47/64	0.7344	18.6531
3/4	0.7500	19.0500
49/64	0.7656	19.4469
25/32	0.7813	19.8438
51/64	0.7969	20.2406
13/16	0.8125	20.6375
53/64	0.8281	21.0344
27/32	0.8438	21.4313
55/64	0.8594	21.8281
7/8	0.8750	22.2250
57/64	0.8906	22.6219
29/32	0.9063	23.0188
59/64	0.9219	23.4156
15/16	0.9375	23.8125
61/64	0.9531	24.2094
31/32	0.9688	24.6063
64/64	0.9844	25.0031
1	1.0000	25.4000

I.P.S. Conversion Chart

Schedule 40 & 80 Pipe

I.P.S.	O.D.		Circumference	
3/4"	1-1/16"	1.050"	3-5/16"	3.299"
1"	1-5/16"	1.315"	4-1/8"	4.131"
1-1/4"	1-11/16"	1.660"	5-7/32"	5.215"
1-1/2"	1-15/16"	1.900"	5-31/32"	5.969"
2"	2-3/8"	2.375"	7-5/32"	7.461"

Rod Holder Selection Guide

T-tops



Leaning Posts



Poling Platforms



Bow & Grab Rails



Location	I.P.S. Pipe	Pipe O.D.	Rod Holder	Description
T-tops				
Outer Ring	3/4" & 1"	1-1/16" & 1-5/16"	F16-2623	Adjustable, Stainless Steel Clamp-on Rod Holder
	3/4" & 1"	1-1/16" & 1-5/16"	F31-2721	Adjustable, Aluminum Clamp-on Rod Holder
	3/4" & 1"	1-1/16" & 1-5/16"	F41-2720	Adjustable, Plastic Clamp-on Rod Holder
	-	1-1/4" S/S Tube	F16-2623	Adjustable, Stainless Steel Clamp-on Rod Holder
Legs	1-1/4" & 1-1/2"	1-11/16" & 1-15/16"	F16-2630	Adjustable, Stainless Steel Clamp-on Rod Holder
	1-1/4" & 1-1/2"	1-11/16" & 1-15/16"	F31-2731	Adjustable, Aluminum Clamp-on Rod Holder
Leaning Posts				
Grab Rail	3/4" & 1"	1-1/16" & 1-5/16"	F16-2623	Adjustable, Stainless Steel Clamp-on Rod Holder
	3/4" & 1"	1-1/16" & 1-5/16"	F31-2721	Adjustable, Aluminum Clamp-on Rod Holder
	3/4" & 1"	1-1/16" & 1-5/16"	F41-2720	Adjustable, Plastic Clamp-on Rod Holder
Legs	1-1/4" & 1-1/2"	1-11/16" & 1-15/16"	F16-2630	Adjustable, Stainless Steel Clamp-on Rod Holder
	1-1/4" & 1-1/2"	1-11/16" & 1-15/16"	F31-2731	Adjustable, Aluminum Clamp-on Rod Holder
Poling Platforms				
Rungs	3/4" & 1"	1-1/16" & 1-5/16"	F16-2623	Adjustable, Stainless Steel Clamp-on Rod Holder
	3/4" & 1"	1-1/16" & 1-5/16"	F31-2721	Adjustable, Aluminum Clamp-on Rod Holder
	3/4" & 1"	1-1/16" & 1-5/16"	F41-2720	Adjustable, Plastic Clamp-on Rod Holder
Legs	1-1/4" & 1-1/2"	1-11/16" & 1-15/16"	F16-2630	Adjustable, Stainless Steel Clamp-on Rod Holder
	1-1/4" & 1-1/2"	1-11/16" & 1-15/16"	F31-2731	Adjustable, Aluminum Clamp-on Rod Holder
Railing				
Bow Rails	-	7/8" & 1" Tube	F16-2600	Adjustable, Stainless Steel Clamp-on Rod Holder
	-	7/8" & 1" Tube	F41-2700	Adjustable, Plastic Clamp-on Rod Holder

Finish Specifications

Finishes specified in this catalog reflect TACO's stock finishes. Other finishes are available provided minimum quantity requirements are met and sufficient lead-time is given.

ANODIZED ALUMINUM FINISHES

Anodizing is an electrolytic process that redeposits a protective coating on an aluminum surface. This coating becomes an integral part of the aluminum and will not peel or flake.

The following is a complete list of anodized finishes available either from stock and/or special order. Please refer to our finish codes when specifying a particular finish.

Brite Dip Finishes

BLY: Silver Brite Dip and Anodized
Anodized finish for chrome like appearance. Withstands corrosive environments. Extrusion flow lines may appear through the anodized finish.

Premium Brite Dip Finishes

BXY: Polished, Brite Dip Anodized
Simulated stainless steel finish for corrosive and highly aesthetically critical environments requiring the most blemish-free aluminum extrusion available. Most extrusion flow lines are removed during the polishing process.

BLS: Brite Dip, Mechanically Linear Sanded and Anodized Fine wire brush and anodized finish. The mechanical

brushing masks unsightly scratches that occur from contact and handling during fabrication or everyday use.

BSA: Silver Brite Dip, 320 Grit
Mechanically spiral sanded and anodized, for round tube and pipe. Mechanically sanded and anodized finish for products with corrosive, high traffic exposure. The mechanical brushing masks unsightly scratches that occur from contact and handling during fabrication or everyday use.

BSS: Silver Brite Dip, 320 Grit
Mechanically spiral sanded and anodized, for round pads. Mechanically sanded and anodized finish for products with corrosive, high traffic exposure. The mechanical brushing masks unsightly scratches that occur from contact and handling during fabrication or everyday use.

BSY: Silver Brite Dip, 180 Grit
Mechanically spiral sanded and anodized, for extrusions. Mechanically sanded and anodized finish for products with corrosive, high traffic exposure. The mechanical brushing masks unsightly scratches that occur from contact and handling during fabrication or everyday use.

Standard Anodized Finishes

TAL: Polished, Clear Anodized
Mechanically buffed, semi-brite. A traditional anodized finish with a subtle polish. Most extrusion flow lines are removed during the polishing process.

VEL: Etch, Clear Anodized (satin)
A cost effective, matte finish. Provides the greatest corrosion protection for minimal aesthetically important exposure.

Painted Finishes

PCS: Silver Powder Coat
Pre-treated, painted and then baked for a durable finish. For moderately corrosive environments. Hardware components can be easily matched for a consistent appearance. Other colors are available upon request.

No Finish

AEY: Mill finish – as extruded
No secondary finishing. Primarily used for industrial applications or for third party finishing.

VINYL RUB RAIL COLOR GUIDE

Colors specified in this catalog reflect TACO's standard rub rail colors. Other colors are available provided minimum quantity requirements are met and sufficient lead-time is given.

DUE TO VARIATIONS IN VIEWING AND THE PRINTING PROCESS, COLOR MAY VARY SLIGHTLY FROM THE ORIGINAL PRODUCT. COLOR SAMPLES AVAILABLE ON REQUEST.

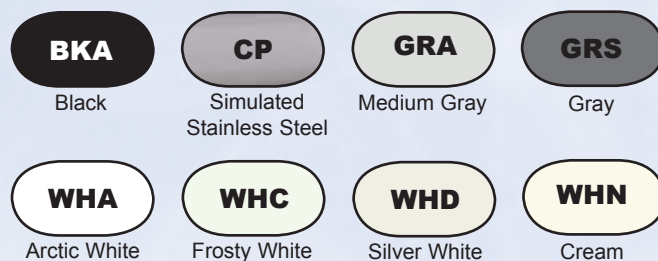

Terms & Conditions

LEAD TIMES

TACO's lead times are based on product availability and the time it will take to prepare and package products to avoid freight damage.

Unless otherwise stipulated, TACO will ship most stock orders the same day if they are received before 10:00 a.m. Orders received after 10:00 a.m. will ship the following day.

All orders will be confirmed via telephone call or fax by Customer Service. If a product is out of stock, you will be advised of the anticipated ship date.

FREIGHT PROGRAM

TACO offers Full Freight Allowance (FFA) for orders shipping to one location and meeting a minimum order value of \$3000. Orders eligible for FFA will ship freight prepaid on one of our preferred carriers or on TACO's own fleet of dedicated trucks.

TACO's freight program has been designed to minimize the amount of damage that can occur in transit while still ensuring efficient delivery time for your needs. The transportation options available are:

- **Common carrier.** Orders will ship freight collect on your carrier of choice. TACO can assist in recommending a carrier and providing approximate freight quotes.
- **UPS.** Orders will ship prepaid and freight charges will be added to the invoice. We will advise on weight and size limitations at the time shipping arrangements are being made. Acceptable UPS standards are less than 150 lbs, 130" in combined length and girth and/or 108" in length.
- Orders can also ship as "**consignee billing**" (recipient of goods will be paying for freight) or "third party billing". Each of these instances requires an open account with the chosen carrier.

TACO Shipping Program. This program allows a quick turn around on lineal profiles. Lineal profiles between 144" and 240" in length are available with delivery to anywhere in the continental U.S. For your convenience, freight charges will be prepaid and added to the invoice. The fee schedule for this program is based on package weight and dimensions, with a flat rate of \$130.00 up to 100 lbs. Residential deliveries will be charged an additional fee of \$50.00.

DAMAGE, LOSS AND/OR SHORTAGE

TACO exercises the utmost care when packaging and shipping products to ensure your order is received in good condition. Any visible damage or lost packages noticed at the time of delivery must be communicated to the freight carrier immediately and a claim should be filed (TACO recommends

adding a written note to the freight bill). TACO can assist with the process of filing a claim by providing information on the number of packages, shipment details and tracking but is unable to file a claim directly with the carrier once the goods have been received and accepted. It is also important that goods are inspected quickly to discover any hidden damages or shortages. Any additional shortages or damages should be communicated to Customer Service within five (5) days of receipt to ensure a replacement order is promptly processed.

RETURNED GOODS POLICY

TACO products are all carefully tested and inspected to ensure optimal levels of performance. It is the responsibility of the receiving party to check all materials to ensure form and fitness for the application for which product was purchased. In the event that material is not fit for application, TACO's liability is limited to material cost. Once product is altered in any fashion, TACO's liability ends. It is TACO's discretion whether product will be repaired or replaced without charge, subject to the performance guarantees stated in TACO's warranty.

All returns require prior authorization from Customer Service. An RM (Returned Materials) number will be issued for goods that appear to be defective or shipped in error. TACO will pay return freight and replace the goods in these two instances. On all other instances, a minimum restocking charge of 20% will be applied and TACO requires the goods to be shipped back freight prepaid. Please contact Customer Service for more information.

The following requirements are also applicable for returned goods:

- A copy of the original invoice must accompany all returns.
- TACO is unable to accept special order products (made to order, cut to length, etc.) for return or credit.
- Goods must be returned in original condition and packaging to avoid additional charges.

BUSINESS HOURS

Office hours are from 8:00 am to 5:00 pm, Eastern Standard Time, Monday through Friday.

PAYMENT TERMS

The accepted terms of payment are COD or Net 30 upon proper credit approval. To obtain a credit application and a list of credit requirements contact Customer Service.

PRICES

Products should be ordered in standard pack multiples (as defined in TACO's marine price sheets). All products ordered in less than standard pack quantities are subject to broken case pricing.

All prices listed on the price list are subject to change without prior notice

MINIMUM ORDERS

TACO does its best to be easy to do business with. Therefore, a minimum order requirement has been eliminated for marine trade customers. However, any orders below \$200 will be charged a \$20 handling fee. Additional charges may apply for cutting, coiling or special packaging.

SPECIAL ORDERS

As a service to TACO customers, products that have been deleted from this catalog can still be purchased if available from stock.

TACO will be pleased to provide pricing for unique lengths and colors of any extruded products listed in the catalog. Minimum quantities vary based on profile weight, material and finish requirements.

SAMPLE POLICY

TACO is pleased to provide free samples of any featured catalog items. To request a 2 to 6 inch sample of any lineal profile, please contact your TACO representative. Samples will ship freight prepaid via UPS-Ground or US mail within 48 hours of the original request.

TACO sells exclusively to marine trade customers.

TACO marine customers consist of marine manufacturers, including boat builders and accessory manufacturers, as well as marine wholesalers, major marine retailers and dealers and specialty marine mail order companies. Consumers and marine aftermarket repair customers are requested to visit the TACO Marine web site at tacomarine.com or contact Customer Relations at 800.653.8567 to locate retailers or distributors carrying TACO products on a regional basis.

POSSESSION OF THIS CATALOG DOES NOT ENTITLE THE BEARER THE RIGHT TO PURCHASE FROM THE COMPANY.

Warranty Information

TACO products are all carefully tested and inspected to ensure optimal levels of performance.

TACO warrants to the original purchaser of its products that should any product be proven defective in material or workmanship within one year of original purchase, they will be repaired or replaced without charge, subject to the performance guarantees stated in this warranty.

The TACO one year limited warranty applies to all products unless otherwise noted.

Five Year Limited Warranty:

TACO Rub Rail Products

TACO Trim and Moulding Products

TACO warrants to the original purchaser of its rub rail products that should any product be proven defective in material or workmanship within five years of original purchase, they will be repaired or replaced without charge, subject to the performance guarantees stated in this warranty.

These products are intended for pleasure crafts, used for recreation. Exposure to harsh marine environments requires all products to be rinsed with fresh water after use and be regularly maintained.

TACO guarantees the performance of these products as follows:

Aluminum Products are guaranteed against fading of anodized finish, corrosion, except for non-anodized surfaces resulting from cutting, machining, tight radius bending, scratching, metal to metal contact or other exposure of the base aluminum. This guarantee does not extend to corrosion resulting from galvanic reaction (improper electrical grounding). Slight fading or dullness of finish over time is a normal occurrence of weathering and does not constitute a defect.

Vinyl Extrusions are guaranteed against significant fading, cracking or swelling and significant reduction of plasticity, modulus, tensile strength and dimensional integrity. Slight color variation is a normal occurrence of weathering and does not constitute a defect.

Stainless Steel Products are guaranteed against loss of luster, corrosion and rust, except that resulting from cutting, machining, scratching or metal to metal contact. This guarantee does not extend to corrosion or rust from galvanic reaction (improper electrical grounding). Slight luster variation over time is a normal occurrence of weathering and does not constitute a defect.

TACO's liability and purchaser's exclusive remedy for damages shall not be greater than the purchase price of the actual product claimed to be defective and TACO shall not be liable for any indirect, incidental or consequential damages, including, but not limited to, present or prospective profits, reliance expenditures or commitments, reputation, goodwill or claims of third parties.

During this warranty period, your TACO product will either be repaired or replaced without charge to the original purchaser, when returned prepaid and insured with proof of purchase date. This warranty covers repair or replacement costs and freight back to the original purchaser-consumer.

This warranty does not apply to any product that has been damaged through alteration, mishandling, misuse, neglect or accident, unless otherwise stipulated. This warranty is in lieu of all other warranties, expressed or implied and no persons or representative is authorized to assume for the company any other liability in connection with the sale of this product. Some states do not allow limitations on how long an implied warranty lasts or the exclusion or limitations of incidental or consequential damage, so the above limitations or exclusions may not apply to you.

This warranty gives you specific legal rights and you may also have other rights that vary from state to state.

Three Year Limited Warranty:

TACO Sport Fishing Products

TACO warrants to the original purchaser of TACO Sport Fishing products to be free from factory defects in materials and workmanship for a period of three years from the date of purchase. Should they be proven defective in material or workmanship within three years of original purchase, they will be repaired or replaced without charge, subject to the performance guarantees stated in this warranty.

These products are intended for pleasure crafts, used for recreation. Exposure to harsh marine environments requires all products to be rinsed with fresh water after use and be regularly maintained.

This warranty excludes the following:

Damage by collision, faulty or incorrect release clips, damage of components due to corrosive cleaners or lubricants, damage as a result of a combination of rough seas and high speeds, and failure to wash off salt water. This warranty is void if product has been damaged by neglect, unreasonable use, improper service or failure to follow maintenance guidelines.

TACO's liability and purchaser's exclusive remedy for damages shall not be greater than the purchase price of the actual product claimed to be defective and TACO shall not be liable for any indirect, incidental or consequential damages, including, but not limited to, present or prospective profits, reliance expenditures or commitments, reputation, goodwill or claims of third parties.

During this warranty period, your TACO product will either be repaired or replaced without charge to the original purchaser, when returned prepaid and insured with proof of purchase date. This warranty covers repair or replacement costs and freight back to the original purchaser-consumer.

Three Year Limited Warranty:

TACO Seat and Table Pedestal Products

TACO warrants to the original purchaser of TACO's Seat and Table Pedestal products to be free from factory defects in materials and workmanship for a period of three years from the date of purchase. Should they be proven defective in material or workmanship within three years of original purchase, they will be repaired or replaced without charge, subject to the performance guarantees stated in this warranty.

These products are intended for pleasure crafts, used for recreation. Exposure to harsh marine environments requires all products to be rinsed with fresh water after use and be regularly maintained.

This warranty does not include the following: Damage by misuse, overloading, faulty or incorrect installation, damage of components due to corrosive cleaners or lubricants, and failure to wash off salt water and otherwise provide proper care and maintenance. This warranty is void if product has been damaged by neglect, unreasonable use, improper service or failure to follow maintenance guidelines.

TACO's liability and purchaser's exclusive remedy for damages shall not be greater than the purchase price of the actual product claimed to be defective and TACO shall not be liable for any indirect, incidental or consequential damages, including, but not limited to, present or prospective profits, reliance expenditures or commitments, reputation, goodwill or claims of third parties.

During this warranty period, your TACO product will either be repaired or replaced without charge to the original purchaser, when returned prepaid and insured with proof of purchase date. This warranty covers repair or replacement costs and freight back to the original purchaser-consumer.

For prompt warranty service, return your TACO product with dated proof of purchase to the address below:

TACO Metals, Inc. Attention: Warranty Department
50 N.E. 179th Street Miami, Florida 33162



Call 800.226.8201 Boat Builders & Accessory Manufacturers
Call 800.653.8568 Aftermarket Distributors

Alphabetical Index

A ACCESSORY-READY™

Drink Holders	97
Female Adapters	55
Filet Table	96
Fishing Pliers & Knife Holder	97
Male Adapters	54,55
Neptune III Leaning Post	58
Neptune T-Top	57
Poly Marine Accessories	96,97
Rod Holders	54
ANGLE MOULDING	23
ANGLES	44

B BACKING PLATES

BALL & SOCKET TOP FITTINGS	62
BASES	
Rail Fitting	67
Seat	88
Table	82-84
BI-FOLD DOOR HINGES	35
BOAT COVER POLE	65
BOW FORMS	67
BRACKET, FOLDING	39
BUTT HINGES	
Economy Style	34
Euro Style	33
Traditional Style	33

C CANVAS TOP ACCESSORIES

CANVAS & UPHOLSTERY TRACK	65
CHANNELS	24
CLAMP-ON	
Lights	92
Rod Holders	76
T-top Grab Rail	57
Neptune III Backrest w/ Grab Rail	58
Neptune III Grab Rail	58
COLUMNS	
Adjustable Seat Columns	87,88
Adjustable Table Columns	81,84,85
Fixed Table Columns	82,83,86
CONTINUOUS HINGES	
Aluminum	31
Stainless Steel	31
CURTAIN TRACK & COMPONENTS	28,64

D DECK HINGES

DOCK BUMPER	98
DOOR FRAME TRIM	26
DOOR TRACK	28
DOOR SNAP	39
DRIP MOULDING	25
DRINK HOLDERS	95,97

E EDGE MOULDING

ELLIPTICAL TUBE	23,24
END CAPS	66
END CAPS	20
EYE ENDS	
Inside	63
Outside	63
EYE STRAPS	64

F FEMALE ADAPTERS

FEMALE PINS	47,51
FLAT BAR	44
FILET TABLES	94,96
FIXED COLUMNS	
Table Columns	82,83,86

FLEXIBLE VINYL

Flexible Vinyl Chrome Rub Rail Insert	18
Rub Rail	13
Rub Rail Inserts	19
Rub Rail Kits	14

FLEXIBLE VINYL TRIM

Flex Trim	23
U-Channel Insert	23

G GRAB HANDLE

GRAB RAILS	
Clamp-on T-top Grab Rail	57
Clamp-On Neptune III Grab Rail	58

GRAND SLAM MOUNTS & KITS

Grand Slam 370 Mounts	69
Grand Slam 270 Mounts	70
Grand Slam 270 Kits	70
Mounting Accessories	75
Mounting Plates	46,75

GUNNEL MOUNT

Filet Tables	94
Rod Rigger	77
Striker Base	71

H HALF OVAL TRIM

HAND RAIL FITTINGS	67
HARD-WIRED LED LIGHTS	

Deck Light	92
Spot Light	92
Spreader Light	92
T-Top with Aluminum Housing	91
T-Top with Mounting Clips	91
HASP	35

HATCH HINGES

Economy Style	33
Euro Hinges	33
Intelli-Hinge	32
Traditional Style	32
HATCH TAPE	29
HATCH TRIM, STAINLESS STEEL	25

HINGES

Bi-Fold Door	35
Butt	33,34
Continuous	31
Hasps	49
Hatch	32,33
Intelli-Hinge	32
Specialty	35
Strap	34
Take-Apart	35
Utility	32

I INSERTS

Co-Extruded Flexible Vinyl	18
Flexible Vinyl	19-20
Rigid Vinyl	13
"Sure Step" Oval Pipe	43
INTELLI-HINGE	32

J JAW SLIDES

K KITS

Center Rigger	72
Grand Slam 270	70
Rigging	74
Rub Rail	14,15
Sport Slam	71
Striker Base	71

L LATCHES

LATCH-tite™ Lifting Handles	37,38
Sundeck Latch	36
Windshield Latch	36

LEANING POSTS

Components	60
Neptune Premium	59
Neptune II	59
Neptune III	58
Neptune III Clamp-on Backrest w/ Grab Rail	58
Neptune III Clamp-On Grab Rail	58
Universal Backrest	59

LIFTING HANDLES

Nylon	37
Round	37,38
Square	38
Stainless Steel	38
LIFTING RING	39

LED LIGHTING

Bright Stick	93
Deck	92
Deep Drop/Float	93
Hard-Wired	91,92
Rechargeable	93
Spreader	92
Spot	92
T-top (& Tube/Replacement)	91
Work	93

M MALE ADAPTERS

MALE PINS	47,51
MALE/FEMALE PAD ASSEMBLIES	49
MARINE ACCESSORIES	

Drink Holder	95,97
Filet Tables	94,96
Fishing Plier & Knife Holder	95,97
LED Lights	90,91
Rigging Strips	95
Dock Bumper	98
Trailer Glyde Slicks	98
Marine Lumber	99

MOULDING

Angle, Rigid Vinyl	23
Corner	28
Drip	33
Edge, Aluminum	32
Edge, Rigid Vinyl	23

MOUNTING PLATES

Accessories	75
Clamp-On	75
Mini Plates	44

N NEPTUNE

Leaning Posts	58,59
T-top, Adjustable	57
Tele-Shade	56

O OUTRIGGER MOUNTS

OUTRIGGERS	
Tele-Outriggers	73
Tel-Center Riggers	73
Kits	70-72

OUTRIGGER ACCESSORIES

Outrigger Line Caddy	73
Base Reducer	79
OVAL PIPE	42,43

P	PADS		RUB RAIL		TAKE-APART HINGES	35
	Male/Female Assemblies	49	Accessories	21	TELESCOPING BOAT COVER POLE	65
	Rectangular Pads	49	Aluminum	16,17	TELE-OUTRIGGERS	73
	Round Pads	48	Canoe Rail	9	TELE-SHADE	56
	Specialty Pads	50	Co-Extruded Flex Chrome Insert	18	T-HATCH TRIM	24
	PINS		Co-Extruded, Rigid	4	TOPS	
	Alignment Set	47	End Caps	20	Neptune Adjustable T-top	57
	Breakaway Pins	47	Flexible Vinyl	13	Neptune T-top Canvas	57
	Female	47,51	Flexible Vinyl Kits	14	Neptune Tele-Shade	56
	Male	47,51	Rail Ends	21	TOE RAIL (SAILBOAT)	17
	Wake Tower	51	Rigid Vinyl	3-9	TOP HARDWARE	
	PINS & LANYARDS	63,64	Rub Strakes	21	Ball & Socket Fittings	62,63
	PIPE – ALUMINUM		Sailboat Toe Rail	17	Deck Hinge, Side Mount	63
	Oval	42,43	Semi-Rigid Vinyl	10	Deck Hinges	62,64
	Schedule 40	41	Semi-Rigid Vinyl Kits	15	Eye Straps	64
	Schedule 80	41	Splice Caps	21	Inside Eye Ends	63
	Tread Inserts	43	Spray Rail	9	Jaw Slides	62,63
	PLATES		Stainless Steel Yacht Style	11	Outside Eye Ends	63
	Clamp-On	75	Stainless Steel Hollow Back	12	Quick Release Pins & Lanyards	64
	Mini Plates	59	Stainless Steel Solid Back	15	TRACK HARDWARE	
	Weld-On	46	S		Canvas & Upholstery	27,65
R	RAIL FITTINGS		SAILBOAT TOE RAIL	17	Slide Track	28,65
	Bases Rectangular	67	SEAT & ACCESSORIES		TRAILER GLYDE SLICKS	98
	Bases Round	67	Pacific Seat	89	TRANSOM ROD RACKS	79
	Elbows	67	Slide Assembly Component	89	TRANSOM TRIM	24
	Universal Tees	67	SEAT & TABLE SYSTEM ACCESSORIES		TRIM	
	RECHARGEABLE LED LIGHTS		Carpet Ring	89	Aluminum Trim	24,25
	Bright Stick	93	Flush Mount Base Plug	89	Canvas & Upholstery Tracks/Welting	27,28
	Deep Drop/Float Light	93	SEAT BASE	82	Channels	24
	Work Light	93	SEAT COLUMN ASSEMBLY	81	Door Frame & Insert	26
	REEL HANGERS		SEAT PEDESTAL SYSTEMS		Drip Moulding	25
	Reel Hanger	78	Adjustable	82	Edge Moulding	23,24
	Reel Hanger Kits	78	Adjustable, Power-Matic	82	Flexible Vinyl Trim	23
	RIGGING ACCESSORIES	74	Poseidon	81	Half Ovals	25
	RIGGING KITS		SEAT SLIDE ASSEMBLY	89	Hatch Trim, Stainless Steel	25
	Center Rigger	74	SEAT SUPPORT	82	Hatch Tape	29
	Premium Rigging Kit	74	SIDE MOUNT TABLE PEDESTAL SYSTEMS		Hatch Track	28
	Standard Rigging Kit	74	Adjustable Tilt, Removable	87	Sliding Door Track	28
	RIGGING STRIPS	95	Fixed Angle, Removable	88	Stainless Steel Trim	25
	ROD HANGERS		SLIDING DOOR TRACK	28	T-Hatch Trim	24
	Rod Hangers	78	SPECIALTY HARDWARE		Transom Trim	24
	Rod Hanger Racks	78	Door Snap	39	U-Channel Insert	23
	ROD HOLDERS		Folding Bracket	39	Weather Seal	29
	Accessory-Ready™	54	Grab Handle	39	T-TOP EXTRUSION PLATES	46
	Aluminum	52-54,76	Lifting Ring	39	T-TOP LED LIGHTING	
	Clamp-On	76	SPECIALTY PADS	50	Deck Light	92
	Flared Weld-On	52	SPLICE CAPS	21	Spot Light	92
	Kite Fishing 3-Rod Holder	77	SPORT SLAM		Spreader Light	92
	Leaning Post Deck Mount	53	Center Rigger	72	T-Top with Aluminum Housing	91
	Leaning Post Weld-On	53	Sport Slam Kit	71	T-Top with Mounting Clips	91
	Plastic, Accessory-Ready	54	Sport Slam Mounts	71	TUBE	
	Plastic, Clamp-On	76	SQUARE & RECTANGULAR TUBE	45	Drawn Tube Aluminum	45
	Poly	77	STEP TREADS & INSERTS	43	Square & Rectangular	45
	Rod Rigger	77	STRAP HINGES		Stainless Steel	61
	Traditional Weld-On	73	Economy Style	34	U	
	Leaning Post Weld-On	73	Traditional Hinges	34	UNIVERSAL BACKREST	59
	ROD HOLDER SELECTION GUIDE	100	STRIKER BASE		UNIVERSAL TEES, RAIL FITTINGS	67
	ROD RACKS		Striker Base, Gunnel Mounts	71	UPHOLSTERY WELTING & TRACK	65
	Aluminum	79	Striker Base Kit	71	W	
	Poly	79	STRUCTURAL EXTRUSIONS		WAKEBOARD RACKS	51
	Rod Hanger	78	Angles	44	WAKE TOWER	
	Transom Mount	79	Flat Bars	44	Hardware	51
	ROUND PADS	48	Mini Plates	44	WALK-THRU WINDSHIELD LATCH	36
			T-top Multi Function Extrusion	46	WEATHER SEAL	29
			SUNDECK LATCH	36	WEDGE PLATE	75
					WELD COVER	54
					WELTING & TRACK	65
T	TABLE PEDESTAL SYSTEMS					
	3-Stage Triton Adjustable	83				
	76mm Fixed	84				
	60mm Fixed	85				
	Adjustable	86				
	Side Mount, Removable	87,88				



Part Number Index

A11-0151.....	16,25	A52-0034	27,65	F14-0042.....	67	F30-1751.....	51	F32-4340.....	48
A11-0152.....	16,25	A52-0037.....	28,65	F14-0043.....	67	F30-1752.....	51	F32-4345.....	48
A11-0317.....	17	A52-0051.....	28,64	F14-0046.....	67	F30-1821.....	47	F32-4350.....	48
A11-0342.....	17	A52-0084	28	F14-0051.....	67	F30-1823.....	47	F32-4435.....	48
A11-0347.....	17	A52-0159.....	28	F14-0076.....	67	F30-1831.....	47	F32-4440.....	48
A11-0511.....	16	A52-0221.....	24	F14-0079.....	67	F30-1833.....	47	F32-4445.....	48
A11-0514.....	16	A52-0222.....	24	F14-0081.....	67	F30-1841.....	47	F32-4450.....	48
A11-0638.....	17	A52-0309.....	28	F14-0093.....	67	F30-1843.....	47	F32-4550.....	48
A12-0303.....	17	A61-0188.....	26	F15-0114.....	67	F30-1851.....	47	F34-0002.....	60
A12-0305.....	17	A61-0189.....	26	F15-0115.....	67	F30-1852.....	51	F34-0005.....	60
A20-1464.....	45	A62-0009.....	17	F15-0139.....	67	F30-1853.....	47	F34-0210.....	55
A23-3458.....	45	BP-150.....	75	F15-0140.....	67	F30-1940.....	60	F34-0212.....	55
A23-7858.....	45	COK-0001.....	74	F15-0141.....	67	F30-2150.....	47,51	F34-0213.....	55
A23-7895.....	45	COK-0004.....	74	F15-0142.....	67	F30-2155.....	51	F34-0300.....	87,88
A40-0812.....	21	COK-0008.....	74	F15-0143.....	67	F30-2300.....	47	F34-0600.....	55
A40-0822.....	44	COK-0015.....	74	F15-0176.....	67	F30-2400.....	47	F35-FRB.....	60
A40-0843.....	44	COK-0020.....	74	F15-0178.....	87	F30-2500.....	47	F35-SDW.....	49
A40-0861.....	44	COK-0022.....	74	F15-0179.....	67	F30-2555.....	51	F35-W.....	49
A40-1043.....	44	COK-0024.....	74	F15-0180.....	67	F30-3500.....	47	F36-2032.....	49
A40-1132.....	44	F11-0100.....	63	F15-0181.....	67	F31-0510.....	77	F36-2035.....	49
A42-0054.....	42	F11-0107.....	63	F15-0193.....	67	F31-0700.....	53	F36-2040.....	50
A42-0055.....	42	F11-0160.....	63	F16-0002.....	87	F31-0750.....	53	F36-2050.....	49
A42-0136.....	42	F11-0163.....	63	F16-0005.....	87	F31-0755.....	53	F36-2521.....	55
A42-0195.....	42	F11-0171.....	62	F16-0006.....	87	F31-0770.....	77	F36-2531.....	55
A42-0245.....	43	F11-0172.....	63	F16-0021.....	39	F31-1500.....	53	F36-3040.....	50
A42-0247.....	43	F11-0174.....	63	F16-0039.....	20	F31-1600.....	53	F36-4340.....	48
A42-0360.....	45	F11-0177.....	62	F16-0150.....	71	F31-1610.....	53	F36-4345.....	48
A42-0361.....	45	F11-0180.....	62	F16-0212.....	71	F31-2200.....	52	F36-4440.....	48
A42-0362.....	45	F11-0182.....	62	F16-1090.....	39	F31-2220.....	52	F36-7001.....	51
A42-0363.....	44	F11-1000.....	63	F16-1200.....	64	F31-2230.....	52	F36-7004.....	51
A42-0364.....	44	F11-1001.....	62	F16-1210.....	64	F31-2240.....	52	F38-2020.....	93
A42-0365.....	44	F12-0101.....	63	F16-1812.....	39	F31-2300.....	52	F38-2050.....	91
A42-0382.....	42	F12-0161.....	63	F16-1853.....	39	F31-2320.....	52	F38-2060.....	91
A44-4248.....	44	F12-0181.....	62	F16-2275.....	38	F31-2721.....	76	F38-2090.....	93
A45-0351.....	41	F12-0300.....	62	F16-2375.....	38	F31-2731.....	76	F38-2500.....	93
A45-0352.....	41	F12-1001.....	63	F16-2500.....	38	F31-2750.....	54	F38-3500.....	92
A45-0353.....	41	F13-0102.....	64	F16-2525.....	38	F31-2760.....	54	F38-3521.....	92
A45-0354.....	41	F13-0105.....	64	F16-2600.....	76	F31-2790.....	54	F38-4500.....	92
A45-0355.....	41	F13-0107.....	64	F16-2623.....	76	F31-2791.....	77	F38-4520.....	92
A45-0356.....	41	F13-0200.....	64	F16-2630.....	76	F31-2850.....	54	F38-5500.....	92
A45-8354.....	41	F13-0210.....	64	F16-2630.....	76	F31-3002.....	79	F38-5520.....	92
A45-8355.....	41	F13-0220.....	64	F16-2700.....	78	F31-3003.....	79	F40-0018.....	87,88
A45-8356.....	41	F13-0230.....	64	F16-2751.....	78	F31-3004.....	79	F40-0024.....	51
A50-0195.....	16,25	F13-0235.....	64	F16-2752.....	78	F31-3503.....	79	F40-0030.....	73
A50-0197.....	16,25	F13-0240.....	64	F16-2753.....	78	F31-3504.....	79	F40-0112.....	28,64
A50-0199.....	16,25	F13-0241.....	63	F16-2810.....	78	F32-0600.....	50	F40-0119.....	28,64
A50-0235.....	24	F13-0242.....	63	F16-2820.....	78	F32-0650.....	50	F40-0278.....	63
A50-0272.....	24	F13-0244.....	63	F16-2900.....	36	F32-0660.....	50	F40-0504.....	64
A50-0275.....	24	F13-0246.....	64	F16-3000.....	38	F32-0900.....	48	F40-0704.....	64
A50-0304.....	24	F13-0250.....	64	F16-3026.....	38	F32-1530.....	49	F40-0718.....	63
A50-0305.....	24	F13-0301.....	63	F16-3040.....	38	F32-2040.....	49	F40-0878.....	63
A50-0326.....	24	F13-0302.....	63	F16-3041.....	38	F32-3040.....	49	F41-2500.....	55
A50-0375.....	24	F13-1085.....	63	F16-3500.....	38	F32-3043.....	50	F41-2520.....	55
A51-0102.....	25	F13-1095.....	63	F17-0106.....	63	F32-4025.....	48	F41-2700.....	76
A51-0104.....	25	F14-0039.....	67	F17-0166.....	63	F32-4325.....	48	F41-2720.....	76
A51-0106.....	25	F14-0040.....	67	F19-0006.....	78	F32-4330.....	48	F41-2750.....	54
A51-0149.....	25	F14-0041.....	67	F30-0021.....	60	F32-4335.....	48	F42-2500.....	37

F45-0336/0339.....36	H30-101034	P10-7512.....99	V12-031720	V30-074429
F45-0339.....36	H30-101535	P10-7524.....99	V12-0334.....20	V30-1005.....23
F80-0039.....67	H30-102034	P10-754899	V12-0338.....20	V30-1008.....23
F80-0040.....67	H30-104033	P10-759699	V12-0342.....19	V30-1312.....23
F80-0041.....67	H30-105032	RK-0001..... 74	V12-0810.....20	V30-1316.....23
F80-0043.....67	H30-106032	RK-0002..... 74	V12-1069.....18	V30-1333.....29
F80-0076.....67	H30-107032	S11-1700.....21	V12-4144.....19	V30-1350.....23
F80-0079.....67	H30-108032	S11-1800.....21	V12-4153.....20	V30-1375.....23
F80-0080.....67	H30-109035	S11-1950.....11	V12-4155.....19	WP-150..... 75
F80-0081.....67	H90-040032	S11-2000.....21	V12-5815.....43	WP-151..... 75
F90-0001.....20	L10-100159	S11-450.....12	V12-5817.....43	Z10-4016.....89
F90-0002.....20	L10-100259	S11-451.....12	V12-5818.....19	Z10-4026.....89
F90-0126.....21	L10-100359	S11-465.....12	V12-9809.....18	Z10-4065.....86
F90-1870.....20	L10-100460	S11-467.....12	V12-9814.....11,19	Z10-4067.....85
F91-0084.....26,29	L11-2600.....58	S11-469.....12	V15-0034.....27,65	Z10-4070.....82,84,86
GS-100 71,72	L11-3000.....58	S11-471.....12	V15-5585.....23	Z10-4075.....85
GS-270 70	M17-1465..... 71	S11-4500.....12	V15-6008.....27,65	Z10-4080.....86
GS-2701..... 70	M17-1565..... 71	S11-4511.....12	V21-0188..... 9	Z10-4085.....85
GS-2741..... 70	OC-0421..... 73	S11-4650.....12	V21-0205..... 9	Z10-4086.....85
GS-2742..... 70	OC-0422..... 73	S11-4660.....25	V21-0456..... 8	Z10-4087.....85
GS370 69	OC-0432..... 73	S11-4670.....12	V21-0457..... 8	Z10-4097.....84,86
GSC-0025 73	OT-0431 95	S11-4680.....25	V21-0458..... 8	Z10-9998.....89
GSE-1001..... 75	OT-0441 73	S11-4690.....12	V21-0460..... 8	Z20-3160.....86
GSE-1002..... 75	OT-0541 73	S14-1049.....61	V21-0874 9	Z20-3161.....84
GSE-1939.....46	OT-0542 73	S14-1065.....61	V21-1025..... 5	Z20-3180.....86
GSE-1940.....46	OT-0551 73	S14-1265.....61	V21-1039..... 6	Z20-3760.....80
H11-112631	OT-0552 73	S14-1465.....61	V21-3670..... 8	Z30-4220.....89
H11-114431	P01-0600.....55	S14-7849.....61	V21-3671..... 8	Z60-7239.....85
H11-200631	P01-0610.....55	S14-7865.....61	V21-9140 9	Z60-7254.....85
H14-011231	P01-1000.....95	S17-0905.....66	V21-9501..... 7	Z60-8266.....85
H14-011431	P01-1001.....95	S17-1305.....66	V21-9502..... 6	Z76-714384
H14-011631	P01-120095	S17-170666	V21-9517 7	Z76-7333.....84
H14-020031	P01-1201.....95	S17-207866	V21-9526 6	Z76-7352.....84
H14-030031	P01-1613.....94	S17-231766	V21-9602 7	Z76-7392.....84
H20-011234	P01-200095	S17-344266	V21-9647 6	Z76-800084
H20-020034	P01-200195	T10-757965	V21-9648 5	Z76-906684
H20-021234	P01-2003.....95	T30-0001.....57	V21-9659 5	Z76-907184
H20-023034	P01-2120.....94	T34-1000.....57	V21-9662..... 3	Z76-9266.....84
H20-030034	P01-2132.....94	T34-1001.....57	V21-9667..... 6	Z76-927184
H20-032035	P01-4821.....94	T34-1002.....57	V21-9678..... 7	Z80-2090.....86
H21-013234	P03-062..... 79	T34-1003.....57	V21-9679..... 5	Z80-2190.....82,86
H21-013334	P03-063..... 79	T36-1050.....57	V21-9692..... 7	Z80-2600.....86
H21-023233	P03-064..... 79	V11-0809.....13,14	V21-9722..... 5	Z80-3001.....81
H21-023333	P03-153..... 79	V11-0899.....13,14	V21-9790..... 5	Z80-3002.....81
H21-023433	P04-011..... 77	V11-0948..... 98	V21-9811..... 3	Z80-3003.....81
H21-040034	P04-041..... 76	V11-2423.....13,14	V21-9846..... 4	Z80-3004.....81
H21-043434	P04-091..... 77	V11-3161.....13	V21-9866..... 5	Z80-4001.....83
H21-060034	P04-0111.....77	V11-3426.....13,14	V22-3162.....13	Z80-4002.....83
H21-063234	P04-191..... 103	V11-3447.....13,14	V25-0240.....23	Z80-4101.....83
H22-155033	P05-06 98	V11-4014.....13	V25-047423	Z80-4102.....83
H23-009233	P06-06 98	V11-4135.....15	V25-9124.....23	Z80-4103.....83
H23-015733	P10-2512.....99	V11-9669.....10	V25-9207.....27,65	Z99-2000.....89
H23-149033	P10-2524.....99	V11-9795.....10,15	V25-9720.....27,65	
H23-149933	P10-5012.....99	V12-0003.....20	V25-9815..... 11	
H23-400033	P10-5024.....99	V12-0005.....20	V30-0109.....29	
H24-285039	P10-504899	V12-0303.....19	V30-0113.....29	
H24-7660.....39	P10-509699	V12-0307.....18,20	V30-0135.....29	

TACO marine.com



TACO Metals, Inc. Headquarters:

50 NE 179th Street
Miami, Florida 33162 USA
800.653.8568
Fax: 800.653.8569

Distribution and Sales:

Miami, FL
Longwood, FL
St. Petersburg, FL
Sparta, TN
Taunton, MA
TACO Europe, The Netherlands

Manufacturing:
Sparta, TN
Kunshan, China

Contact Information:

Boat Builders and Accessory Manufacturers
Please call 800.226.8201 or
727.577.3377 • Fax 727.576.1053

Aftermarket Distributors
Please call 800.653.8568 or
305.652.8566 • Fax 800.653.8569